

JULY/AUGUST 1977 VOLUME 2, NUMBER 2 CANADA \$1.50 AUSTRALIA, EUROPE & JAPAN \$2.00 USA \$1.25

the electronic music magazine

# Synapse

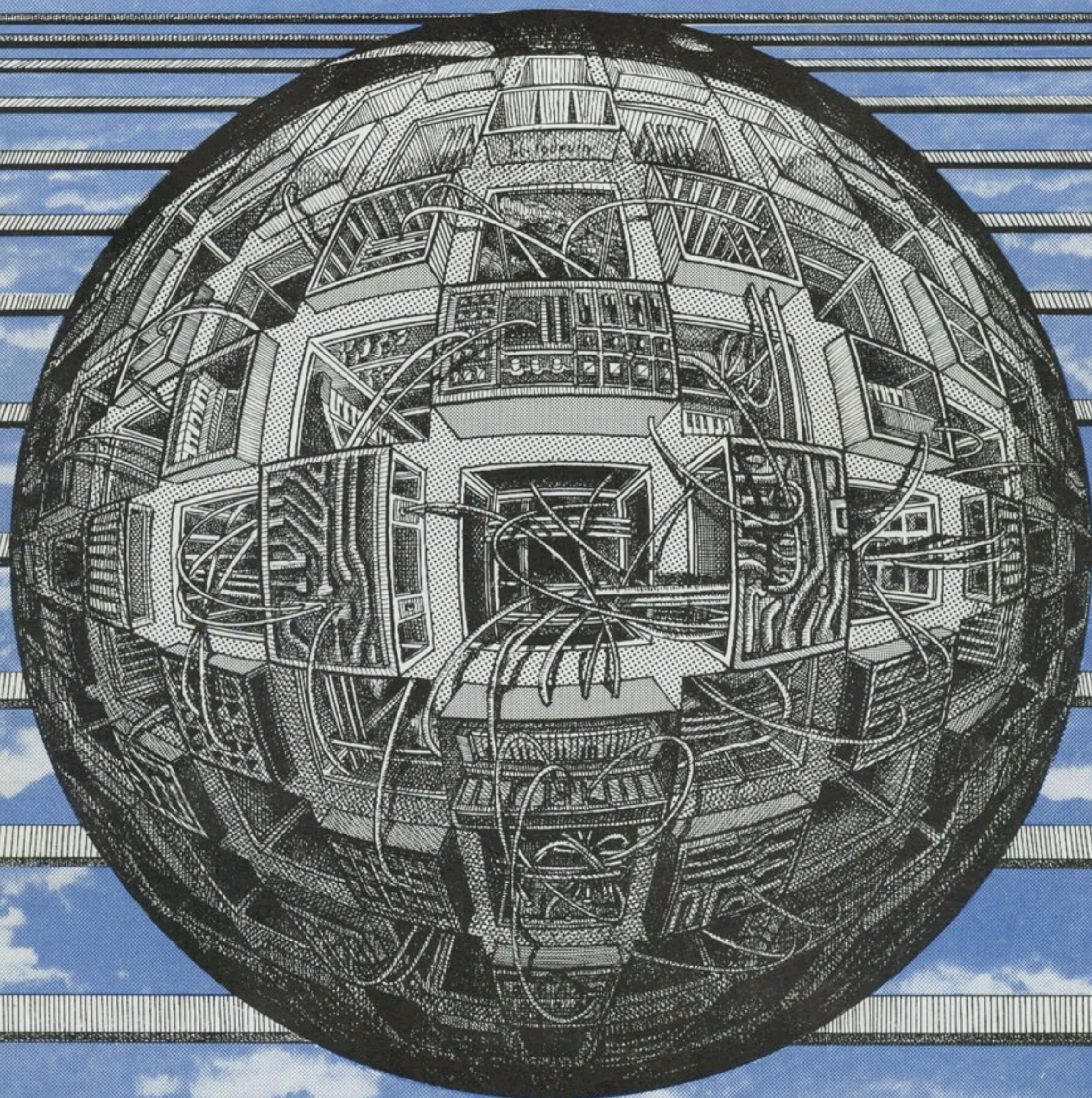

TANGERINE DREAM

SYNTHESIZED VIDEO



# EVOLUTIONARY

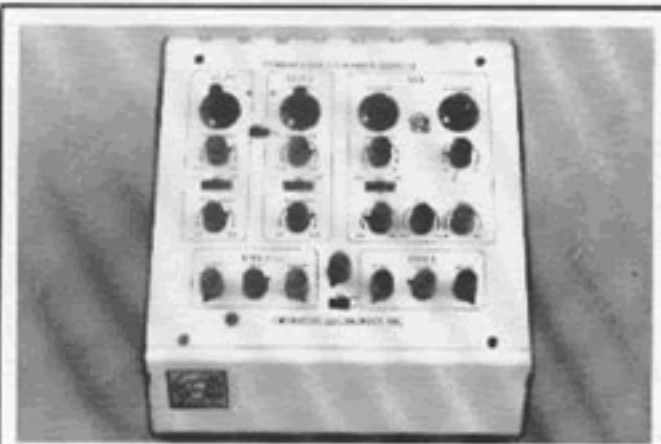

**DECEMBER 1974**  
The first Oberheim Synthesizer Expander Module shipped.

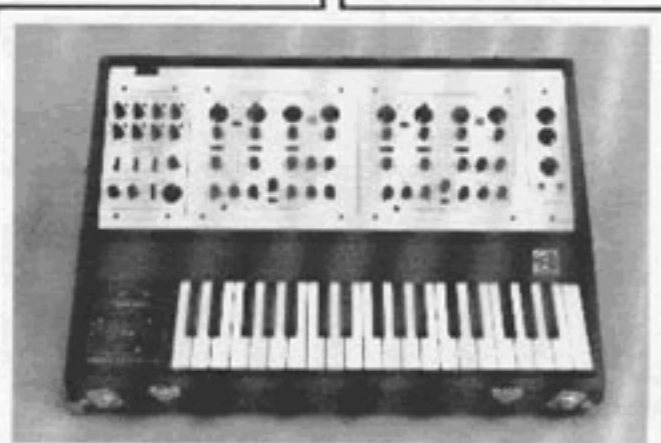

**AUGUST 1975**  
The first Oberheim Two Voice Polyphonic Synthesizer with mini sequencer squad.

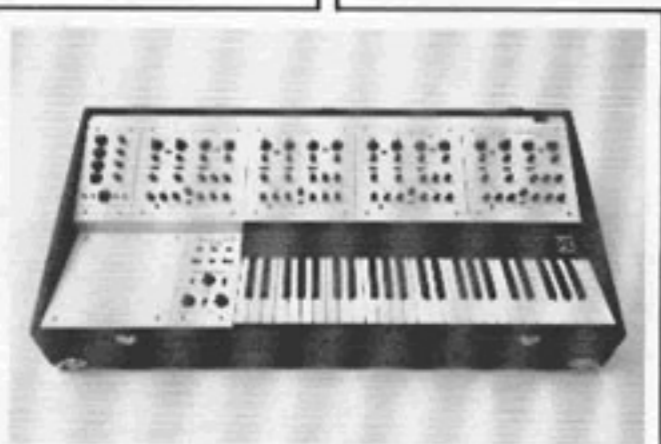

**NOVEMBER 1975**  
The first Oberheim Four Voice Polyphonic Synthesizer shipped.

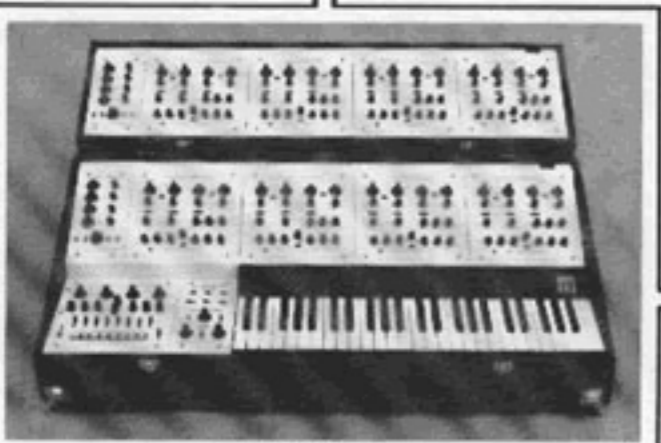

**MAY 1976**  
The first Oberheim Eight Voice Polyphonic Synthesizer shipped.

It hasn't been very long since Oberheim entered the synthesizer field. However, a lot has happened since that day in December 1974. The Synthesizer Expander Module, because of its innovative/modular design approach (i.e., A multitude of internal strapping options internal to the unit), has lent itself perfectly to the evolution of the most versatile live performance synthesizers commercially available today. Actually it was quite by accident that it turned out that way. However, as our Polyphonic Synthesizers evolve, musician feedback continues to give birth to new ideas, options and interfaces. To name just a few... Master Filter Pedal, Vibrato Pedal, Multiple Keyboards, Portable Keyboards, Cassette Interface. There are others and more to come and chances are the Oberheim will lend itself to that particular modification or change that's unique to you. The really important thing to note is all enhancements, changes, modifications and future options are retrofit-able to units already in use.



**Oberheim**

Some Things Are Better Than Others

Oberheim Electronics, Inc., Dept. EV |  
1549 9th St., Santa Monica, Ca 90401

\*Available only on special order through your local retailer. Allow 45 to 60 days delivery.



**OCTOBER 1976**  
The first Oberheim Polyphonic Synthesizer Programmer shipped.

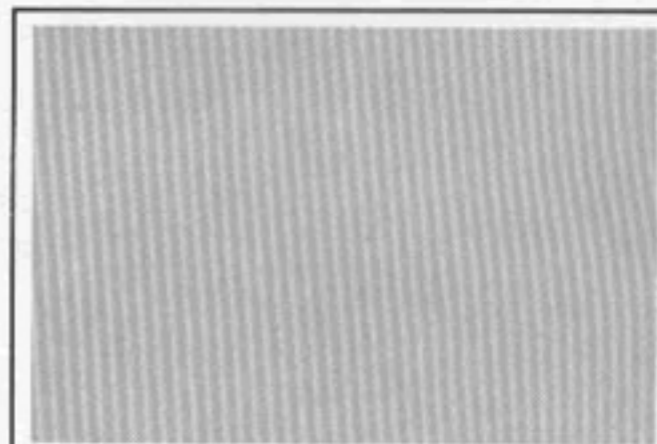

**SPRING 1978**



**WINTER 1977**

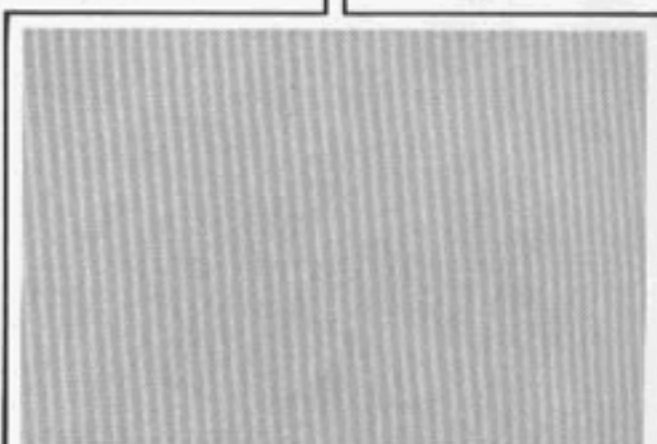

**AUGUST 1977**  
The first Oberheim Polyphonic Synthesizer Programmer Cassette Interface will be shipped.



**FEBRUARY 1977**  
The first Oberheim Dual Manual Eight Voice Polyphonic Synthesizer with Programmer shipped.\*



Editor  
Douglas Lynner  
Art Director  
Chris August  
Photography  
Bill Matthias

Correspondents  
Boston: Kenneth Perrin  
Northern California: Phil Loarie  
Connecticut: Chuck Scribner  
Maryland: Paul Medlock  
New York: Carter Thomas  
Oklahoma: Richard Bugg  
San Diego: Steve Roach  
Sweden: Gregory Allen Fitzpatrick

Contributing Writers  
Steve Bilow  
Alex Cima  
Randy Cohen  
Tom Davey  
Bob Davis  
Peter Hillen  
Arman Matthews  
Magic Moe  
Danny Sofer  
Eric Valinsky  
Richard Waldholm

Contributing Artists:  
Sue Denim  
Bill Matthias  
Pierrot  
Lisa Townsend

Cover Illustration by  
Jean-François Podevin

Contributing Photographers  
Louise Etra  
Arlene Koretsky  
Lawrence Lauterborn  
Jamie Newman

SYNAPSE MAGAZINE is published bi-monthly by Synapse Publishing Co., 2829 Hyans Street, Los Angeles, California 90026. (213) 383-7933. No part of this magazine may be reproduced, either mechanically or by other means, without the written permission of the publisher. Copyright 1977 by Synapse Publishing Co. Printed in the United States of America.

MANUSCRIPTS: We cannot be responsible for the return of any unsolicited manuscripts, photographs, artwork or scores. All contributions are welcome, should include a self-addressed stamped envelope, and should be addressed to: SYNAPSE MAGAZINE, 2829 Hyans Street, Los Angeles, California 90026.

RETAIL SALES: Synapse is available at bulk rates for retail sales. Interested dealers should contact Synapse (213) 383-7933.

SUBSCRIPTIONS: U.S. and Canada \$6.00 for six issues, foreign subscriptions \$7.50 for six issues. All subscriptions must be in U.S. funds. Single copy newsstand price is \$1.25, \$1.50 Canada, \$2.00 Australia, Europe & Japan.

CHANGE OF ADDRESS: Notify SYNAPSE MAGAZINE/SUBSCRIPTION DEPARTMENT, 2829 Hyans Street, Los Angeles, California 90026. Please send both the old and new addresses, and if possible, the mailing label from a copy of SYNAPSE.

## A Cosmic Sound Gets Down to Earth

*Intergalactic aims of a moulting music scene.*

Arman Matthews

12



## Synthesized Video

*"Listening is very different from looking."*

Randy Cohen

14

## Tangerine Dream

*Many discs, Sorcerer soundtrack, two US tours and now, . . .*

Doug Lynner

18



## Bernie Krause

*Over a decade of synthesis.*

Doug Lynner

23

## Techniques of Electrophony

*A new 'phony to out 'phony all 'phonies.*

Eric Valinsky

28

## Space Rockers Unite!

*Magic Moe outlines ideas for cooperative electronic music promotion.*

Magic Moe

29

## Beyond the Clang Tone

*Alternative ring modulation.*

Stephan Bilow

30

## Conceptual Traditionalism

*The 57th Audio Engineering Society Convention.*

Eric Valinsky

31

## Interfacing Acoustic, Electric & Electronic Keyboards with Synthesizers

*With an emphasis on techniques for live performance.*

Alex Cima

32

2:2	2	High Points & High Jinks in the	
Letters	2	History of Electronic Music	35
What's Happening	6	Computers	36
Discola	8	Equipment	38
Performance	10	Listings	39
Synthesis	34	Classifieds	39



# 2:2

The concept of controllers has undergone many changes as of late. The two largest areas of innovation are traditional instrument based controllers and computer controllers. A look at this month's What's Happening will illustrate the activity. The trend leads to the universal accessing of synthesizers. Not because there will be one ultimate controller but because any information producing phenomom can be used to control a synthesizer. It is conceivable that any instrument (musical or non-musical) whose logic and mode of operation you are comfortable with can provide the bridge between you and a synthesizer. After all, instruments have never been more than translators anyway.

I would like to extend an invitation to all Synapse readers to give some thought to new types of controllers and to send the ideas, drawings, etc. to Synapse. If the response warrants, a column of your ideas will begin in the Sept./Oct. issue.

# LETTERS

## Why?

Since I think your magazine is one of the only reasonable journalistic treatments of either art or technology, I consequently think I have a vested interest in helping to realize all it's potentials. Thus, I make the following criticisms and recommendations for what is already a very fine and well done magazine.

One of the best parts of Synapse is the record reviews, which are uniquely intelligent. Tom Davey and Danny Sofer show an excellent grasp of the essence of the music they listen to and a clever ear for what devices and patches are used therein. In fact, ninety five percent of the record reviews that I agree with can be found amongst the pages of Synapse. Why then do you print the reviews of Tangerine Dream done by what I can only call the "obnoxious Richards", Waldholm and Einhorn? The record reviews by the former have already been rebutted by letter in Synapse, so I will only deal with the latter's Performance Review (Vol. 2, #1) of Tangerine Dream in New York.

First, I will not even try to understand why "groovy-acid-be-in's" are either "stomps" or "macabre", or how acid associations came as a "shock" to *anyone* who has read the name of the group-Tangerine Dream. I won't even try to understand why Einhorn's uneasiness doubled when the "hard driving synthesized motor rhythms . . . started up", when he admits in the same line that this is something "the Tangs presumably are well known for". In fact, these are the same basic synthesized rhythms as on the "Rubycon" album of which he has "such gentle associations". If he is one of those people who play modern electronic records at -40 db, then he has no business reviewing a concert which has as one of it's basic advantages ultimate volume and dynamics.

Maybe if Einhorn could have listened to the concert repeatedly, as he did with the recording "Rubycon" he could have caught the subtleties he obviously missed. For those subtleties exist in the imaginative use of rhythms and in the phrasing, tempo and careful improvisations of the keyboard playing. Perhaps if Mr. Einhorn was "reasonably stoned", he would have been more sensitive to those subtleties, rather than having "been fooled" into looking for normal use of musical concepts. The subtlety of control and nuance given to the rhythms have enabled Tangerine Dream to create a new, unique EM/rock fusion which is the farthest thing from being merely an attempt to enter the rock mainstream. The music is more accessible now merely from having more power and scope.

One trend I seem to find in Synapse, especially in the latest issue, is an attempt to accomodate more of the people-who-own-an-Odyssey-and-want-to-know-more-than-just-this-knob-makes-it-brighter-and-this-switch-gives-a-vibrato-effect. This is admirable (as well as lucrative), but there is a relative abundance of literature on the subject, whereas there is nothing on things like Digital Dronezilla or "How did Tomita create that sound". I think the forefront of electronic music would be extended greatly by some sort of presentation of how some of the better synthesists get the sounds they do, as far as patching the equipment goes.

Ken Gracen  
Van Nuys, Cal.

P.S. What is an E.V.I.? Also, do you already know what a PBGSynthesizer comprises?

*E.V.I. is short for Electronic Valve Instrument. It is a controller manufactured by Steiner-Parker that utilizes trumpet fingerings and features a rotary switch that transposes the*

*voltage by octaves and fifths.*

*Sorry, details on Tangerine Dream's PBG synthesizers were not available by press time but the address is: PBG Synthesizers, Landwehr 11, 4 Hamburg 76, Germany.—Ed.*

## In the shadow of 12 tones

Within the next month I will send you sample copies of my Xenharmonic Bulletin, which explores the vast possibilities outside the conventional 12-tone tuning-system. The synthesizer should be the principal instrument for such explorations, but since most of them have ordinary 12-tone keyboards, few people seem to realize what could be done *RIGHT NOW* in this regard. On some models, any other equal temperament (I particularly recommend 19, 22, and 31 tones per octave) can be "mapped onto" the conventional keyboard, so the limitation on those synthesizers is in *appearance* only.

I have been disappointed and disquieted by the general timidity in this field, as though the mechanical and financial limitations of the piano still existed for these new instruments. Some people, I know, have been intimidated by notation problems—for them, why don't they try playing existing music in 19 or 31—it works 90% of the time. Others have confined their exploration to "tone-bending": for them, there are non-twelve systems which would provide a finer grid and thus a systematization of tone-bending.

Personally, I am tired of 12-tone because I have tuned pianos and organs to it for 38 years and have a right to explore something else! As a composer of 40 years' standing, I do not care to put out more warmed-over Rimsky-Korsakov, reheated Debussy, or resublimed Schonberg. So I re-fretted guitars and built other



# SOUND~A~ROUND

QUAD PANNER MODEL QP~1

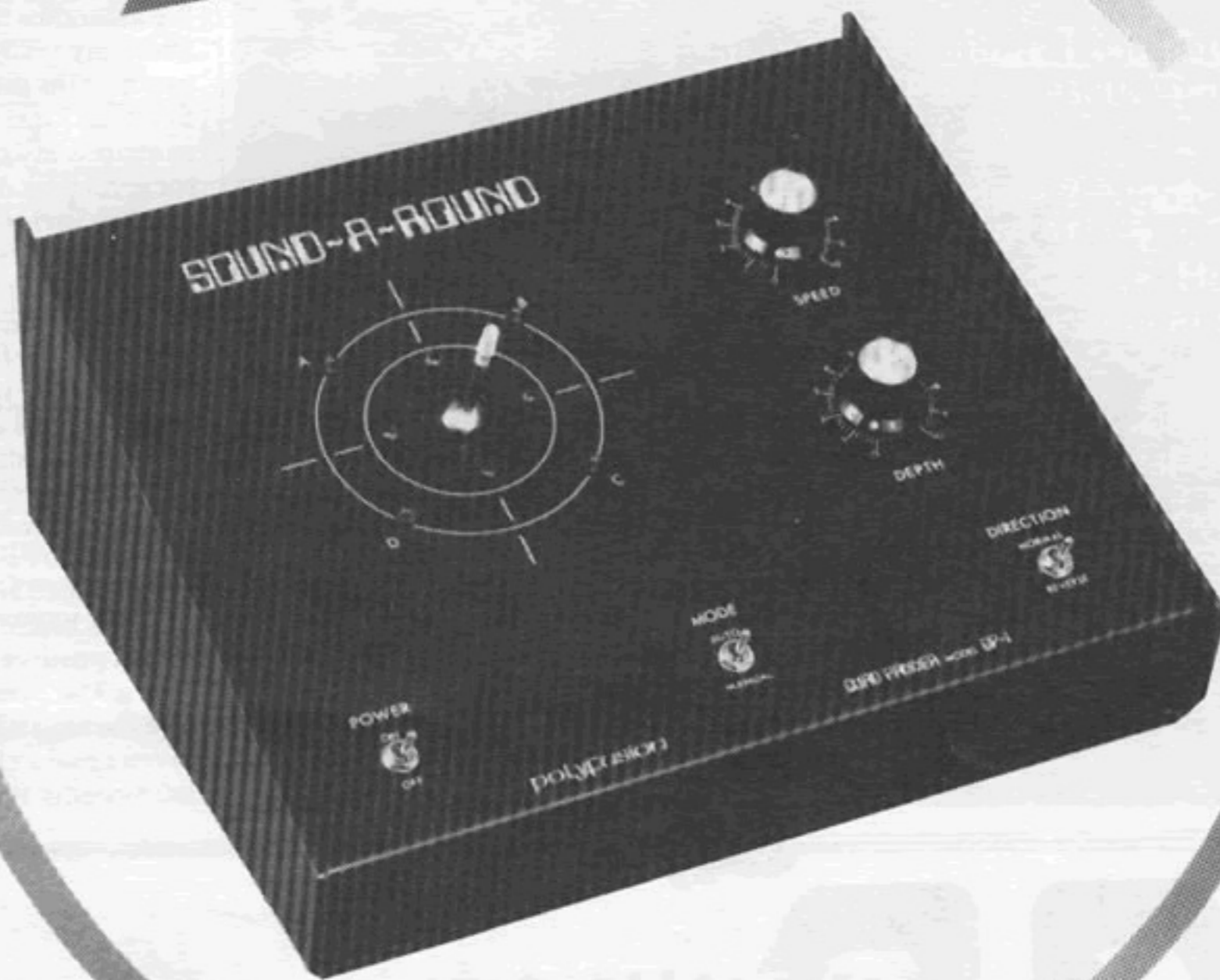

The SOUND-A-ROUND can turn your quad system into a dynamic, moving sound environment.

From a sublimely slow shift of sound from channel to channel to a neck wrenching spin, you can precisely control the speed of revolution with either the panel control or optional foot pedal.

From barely perceptible changes in loudness to a blatant jumping effect from channel to channel, the depth can be controlled with either the panel control or optional foot pedal.

The direction of revolution can be instantly reversed with a switch.

Four LEDs let you know what the SOUND-A-ROUND is doing for you—indicating speed, direction, and channel levels.

A joystick control allows you to precisely maneuver the sound by hand if you prefer.

The SOUND-A-ROUND is available in the standard one input to four output configuration and also in two and four input versions.

All this unique and stunning capability for only \$299.95. Ask your dealer for more information or write to:

# polyfusion

160 Sugg Road, Buffalo, New York 14225 (716) 631-3790



## LETTERS

instruments several years ago, and have a number of collaborators (unfortunately, in distant places so all they can do is write me).

I see two other reasons for this general timidity: Most synthesizers are monophonic, therefore the composer cannot hear any *CHORDS* in the new tunings until the overdubbing is completed. Not hearing new harmonies and surrounded by a sea of 12-tone harmony, it is next to impossible to *IMAGINE* something outside the 12-tone squirrelcage. Refretted guitars are one answer for that.

2nd reason: too much music today is premeditated—even rigidly serialist and written for eyes rather than ears. The traditional notation for conventional instruments and the reluctance of performers to go against their years of training (I want to say programming) into a narrow rut, make it impossible for composers to ask for certain

things which will never get played. My answer to this is composing on new or modified instruments and combining line after line directly onto tape, so that no conventional performer will ever be bothered by my experiments. Sure saves lots of eyestrain for all concerned!

In short, I don't want to see the future of the Synthesizer thwarted by the Piano's Ghost.

Ivor Darreg  
349½ W. California Ave.  
Glendale, Ca. 91203

**Tom Davey Exposed**  
Hath he no shame? Tom Davey, Moldarian title withheld, has phreened the good name of all self-respecting Moldarians with his mendacious claim that he was instrumental in preventing the deadly invasion of the Silurian Slime Beings. We find his rendering of the battle to be inconsistent with historical fact. For it was we, The High Hollywood Moldarian Royalty who were principally responsible for the quashing of the dreaded Silurians. Only a formal apology will solve our seditious mood and reunite us with our

provincial brethren to the south. May the Seven Sons be with you all.

Sundar, Eelar, Bonar,  
Creetar HHMR

*What have we started?*—Ed.

### Super Synapse

Thank you so very much for sending me your vol. 2 #1 issue. As usual (you've made it a habit) it's a great issue! As a matter of fact, I'd be worried if I were you. Honest! Once you get your readers used to quality, you have to keep offering them quality, and that's quite a job! I've been buying and subscribing myself to *Popular Electronics* since 1967 and I've witnessed how a magazine goes up, goes down, goes up again, etc. My particular interest in *Popular Electronics* has always been audio and electronic music. But it's easy to see that their only concern isn't these topics. Every month I'd look up in their index for articles and projects on electronic music and I was overjoyed every time I'd find one and I'd gobble it up in no time! (By the way, they have an excellent contributor, Mr. Don

Lancaster. Why not try to contact him? It's just a suggestion.) Don't get jealous if I mention *Popular Electronics* too much 'cause after all it was through them that I learned about you, in an ad in their electronics market place! So much for *Popular Electronics* anyway. But alas! Now I have the assurance that I can read about my favorite topics every two months through *Super Synapse*! I just can't find words to express my gratitude to you for giving me this pleasure! (English isn't my native Language). Keep the good work up and receive my congratulations and best wishes for the future.

One thing I would like to see in your mag is an interview with guitar synthesizer wizard Robert Fripp (ex-Crimson). I saw the *Crimson 2* times and was fascinated by their effects and would like to read about the *Crimson brain*, Fripp! I'm almost positive that he used an EMS guitar synthesizer and I love the way it sounds. (I haven't had a chance to hear the 360 Systems' Polyphonic Guitar

Synapse



**ELECTRONIC MUSIC:  
IN-HOUSE PRODUCTION  
SCORING/ARRANGING  
RECORDING • RENTAL  
SALES • CONSULTATION  
INSTRUCTION • 2825  
HYANS ST. LOS ANGELES  
90026 • (213) 487-5148**

**now  
16  
track**

Sound Arts



Synthesizer featured in Vol. 1 #4. Do you know of a record where somebody plays it? If you do could you let me know?)

Well, for the moment, I think It's time to say good-bye. Until we say hello again, I remain  
Freddy Bello  
Pomezia, Italy

Three recommended discs on which the 360 Systems Polyphonic Guitar Synthesizer are played are: *Symphonic Slam* by Timo Laine—A&M [SP-4619], *Captain Fingers* by Lee Ritenour—Epic [PE-34426], and *Inner Worlds* by Mahavishnu Orchestra—Columbia [PC-33908].—Ed.

#### Independent Solution

I am very anxious to read a magazine devoted to electronic music that is not put out by some manufacturer trying desperately to push his product. Please enter me on your subscription list.

Ken Collins, Charlotte, N.C.

What we need is another 100,000 just like you. Thanks.  
—Ed.

# Synapse

## Back issues are available!

QUANTITIES LIMITED

Volume 1 Number 4  
Malcolm Cecil & Tonto  
\$2.00

Volume 1 Number 5  
Pat Gleeson, Gary Wright  
\$1.75

Volume 1 Number 6  
Synthesizers on  
the Eco-Front, Roger  
Powell & Todd Rundgren  
\$1.50

Volume 2 Number 1  
Robert Moog,  
George Duke, Herbie  
Hancock, Vocal Synthesis  
\$1.50

Sorry, Volume 1 Numbers 1, 2 & 3 are sold out.  
If we get enough requests, we will reprint them.

Enclose 50 cents per copy for First Class postage  
and handling, U.S. funds only. Send orders to:

**Synapse / Back Issues**  
2829 Hyans Street  
Los Angeles, California  
90026

# Synapse

What are patch-programmable modules? These are Serge Modules which can be patched to fulfill more than one single fixed function. This makes even a small Serge System many-fold times more powerful than an equivalent sized traditional synthesizer, because the Serge can be patch-programmed to function in a far wider range of ways, according to need.

Check out the following Serge System:

1 New Timbral Oscillator, 1 Standard VC Oscillator, 1 VC Filter (BP, HF & LP), 1 Dual Positive Slew, 1 Dual Negative Slew, 1 Dual Audio Mixer, 1 Triple Waveshaper, 1 Smooth & Stepped VC Generator, 1 VCA, 1 Ring Modulator, 1 4 Stage Programmer (presets), 1 Mic. Preamp, 1 Reverb.

Inexpensive? With a power supply, patchcords, Panels

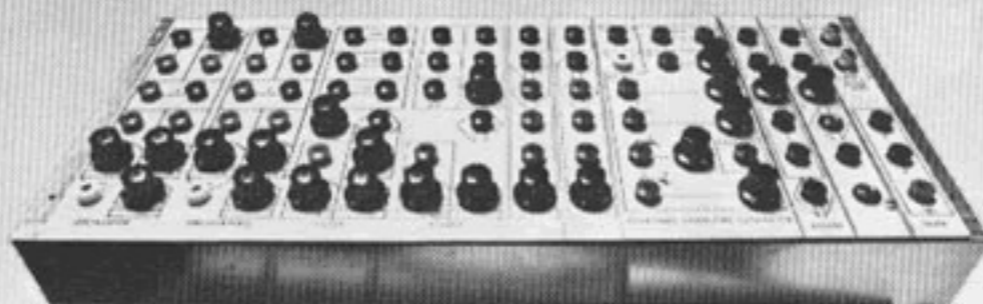

and two metal cases, the cost of this system is \$1111.50 in kit form, \$1500.00 fully assembled, f.o.b. LA, Calif.

By patch-programming this system, a whole set of additional functions becomes possible, including:

8 VC Oscillators, five of which can have VC waveshaping. 3 VC Portamento (lag) modules, not including the one built into the NTO. 1 VC rate controlled Sample and Hold. 1 VC Staircase Generator. 1 VC pseudo random timing and envelope generator. 2 Envelope Generators with independent VC rise and fall times. 2 Trapezoidal low frequency VC gen-

erators. 1 Triangle wave low frequency VC generator. 2 Envelope detectors (followers) with VC decay rates. 2 VC Pulse delays and pulse monostables. 2 VC sub-harmonic sawtooth generators (audio range). 2 VC sub-harmonic timing pulse low frequency generators. 3 Non-linear audio "filters" (can be used as VCAs). 1 Control Voltage Multipliers. 3 Non-linear distortion generators with frequency doubling, quadrupling, etc. 1 Pitched percussive or resonant sound generators. Etc. . . .

Features of the Serge:

Professional Quality. Fully modular, innovative modules not available elsewhere. Kits

or assembled systems. Fiberglass boards and A-B audio pots. Kits feature pre-assembled and tested PC boards. Less than 1% failure rate. More than 37 modules to choose from. More VC functions than is available anywhere else. Accurate VC of all timing related functions. Dual and even triple modules. Patch Programmable modules. A company committed to evolving new modules. Willingness to make custom modifications, a system that is personally affordable.

Catalogs available at \$1.00. The Serge System Instruction Manual available at \$2.00 each. California residents add sales tax. Refundable with the first order. Delivery time is from 4-7 weeks.

**Serge Modular  
Music Systems  
Department Z  
1107 1/2 N. Western Avenue  
Hollywood, California  
90029**

# serge modular music systems



# What's Happening

... Watch for the new **Synapse** column appearing monthly in **Gig** magazine. The first installment, to be on guitar synthesis, will be in the September issue. . . .

... The **Electronic Music Center, University of Texas at Austin**, recently sponsored five ten hour long pieces in one week, collectively entitled **The Electric Sinfonia**. The concept was to allow the audience more integral involvement in the compositional process than normally attainable in a conventional concert setting. The audience was invited to operate the various synthesizers and therefore break down the listener-performer-composer syndrome. . . .

... **Bob Easton of 360 Systems** has furthered his company's excursion into instrument/synthesizer interfaces with the release of the **Model 76 Pitch Follower**. Unlike 360's **Slavedriver**, made for guitar only, the **Model 76** will accept and follow most brass, reed, and wind instruments. 360's **Pitch Follower** lists for \$595 and can be used with the majority of synthesizers. . . .

... For random music enthusiasts, **Inner Space Electronics** releases the **Infinitune**. The \$75 kit outputs tone sequences "very similar to human-composed passages" when you connect it to your amplification system. Multiple systems may be interfaced to yield polyphony and the unit may also control a synthesizer. . . .

... Several microcomputer based music systems are being marketed through the hobbyist portion of the computer world. The **Software Technology Music System** is a complete system minus amplification and connectors. The timbral quality is claimed to simulate a reed organ. The three voice system can be programmed by the user and "starter" musical selections are also available. The **Solid State Music SB-1 Synthesizer Board** is

a waveform synthesizer card designed to interface with the S-100 bus. The card enables a monophonic line to be controlled by software. Polyphonic capability is attainable with multiple cards. The kit [parts and software] sells for \$250 and assembled and tested for \$350. The **MG-1 Music Generator** by **Galaxy Systems** simultaneously generates forty-nine notes which can be independently commanded on or off. Four standard "voices" are provided and additional voices may be programmed. The basic unit lists for \$299 fully assembled and

tested. Possibly the most interesting of the bunch is the **Logistics Synthesizer** by **Logistics**. The system is comprised of two boards and is fully real time. Among its' features are speech synthesis, polyphony, patch memory and F.M. synthesis. List is \$525. One last item of interest in this S-100 bus compatible group is **Speechlab** by **Heuristics Inc.** It's function is to digitize and extract data from a speech waveform and apply pattern matching techniques to recognize the vocal input. At \$249 in kit or \$299 assembled it could be interesting.



Russ Kunkel and John Guerin testing prototypes of Pollard Industries' Syndrum percussion synthesizer.

... A little beyond most of our means but never the less interesting is the **German EMT 250 Electronic Reverberato Unit** with digital processor. The device lists for \$15,000. Invented by **Barry Blesser**, the **EMT 250** features reverberation via nineteen different delay elements, each with independent delay times, delay with four channels that can be individually adjusted from 0 to 315 ms. in 5 ms. steps, echo using feedback loops, "space", which is ten second delayed reverb, chorus effect and stereo phasing. The unit has control possibilities and is available through **Gotham Audio Corporation**, 741 Washington St., New York, N.Y., 10014 and 1710 N. LaBrea Ave., Hollywood, Cal., 90046 . . . .

... The **Real\* Electric Symphony (R\*ES)** played to capacity audiences during it's spring 1977 European concert tour. The **San Francisco Bay Area** based group of composer/performers under the direction of **Ron Pellegrino** was featured on international music festivals in Munich, Germany and Bourges, France. The **R\*ES** presented a series of three events in Paris where people were turned away at the door each night. The group was recorded by **Radio France-Music** and **Radio France-Culture** for future broadcasts in Europe. The next major event planned by the **R\*ES** is the **second San Francisco Bay Area Performance Arts Festival** to be held at the **Great American Music Hall** in **San Francisco** during the autumn of 1977. For more information contact: **The R\*ES**, P.O. Box 1475, Novato, Cal., 94947, [415] 897-5974. . . .

... **Octave Electronics** has added two new synthesizers to their line. The **Cat SRM** features the ability to switch between monophonic and polyphonic [2 note] keyboard. When in the polyphonic mode, a two note memory is enacted so that both notes will sustain [hold pitch] after the keys have been released. Other



features include mixable wave-shapes, LFO delay and LFO monitor [visual]. The Kitten Synthesizer is a small and inexpensive performance synthesizer that includes two suboctave divisions of the oscillator to simulate the effect of three oscillators, mixable waveforms, an "8 note sequencer" patch, LFO delay and LFO monitor. The Cat SRM and the Kitten Synthesizers list for \$1095 and \$599 respectively. . . .

. . . L.A. based Pollard Industries Inc. has released Syndrum. The manufacturer is careful to distinguish between synthetic percussion and electronic drums as the Syndrum wishes to be associated with the latter. The drum heads are dynamically sensitive and are attached to independent electronic "brains". Functions include volume, sustain, snare, sweep, vibrato, rate and speed [three waveforms including sine], tune, fine tune, tuning pedal, kill switch and sensitivity. A set with four drums, four "brains" and a foot pedal lists for \$1495. . . .

. . . A new technique in sound reproduction has been developed



Barcus-Berry's new glass plate tweeter, the Audio Plate.

by Barcus-Berry called the Audio Plate. The Audioplate is nothing more than plate glass with an "energizer" bonded to it's back. The unit is used in place of a tweeter and has a reported frequency response of up to 250,000 cycles. . . .

. . . Home Recording for Musicians by Craig Anderton is slated for a fall release by Guitar Player

Publications. The book is designed to demystify recording and will cover many topics including mixing, tape selection, special effects, construction projects and what a record company wants to get in a demo package. . . .

. . . Sound Arts Studio's, L.A., have expanded their electronic music production facilities to include full sixteen track recording.

. . . The Electronic Synthesizer Ensemble will be performing at the Celler Theatre, corner of Vermont and 1st streets, L.A. on July 24, 1977 at 8:00. The group features Darrel Johansen, Jill Frazier-Miller, Gary Chang and Peter Grenader. Admission is \$2.50 . . . .

. . . Oberheim Electronics are applying their programmer to their new single voice performance synthesizer. All parameters of the system are user pre-programmable and cassette storage will be available soon after the systems release [Oct. '77]. Two special features are a filter that can be switched from two to four pole and a pitch bend lever that when moved away from the pitch bend mode, interjects noise [in the good sense] in the VCA. It is also possible to bend only one of the two oscillators while leaving the other stationary. . . .

. . . ARP Instruments recently completed the production prototypes of their Avatar and Centaur guitar synthesizers. The Avatar is an Odyssey based system [no keyboard of course] that turn to page 40

## Synapse

# STEINER-PARKER

## THE STEINER-PARKER MICROCON

The Steiner-Parker Microcon is a complete synthesizer (less keyboard) in a single module. It has its own power supply, VCO, LFO, VC filter and envelope generator, thereby combining all of the most needed parts of a synthesizer in one unit. It can be used with synthesizer accessories such as sequencers, electronic valve instruments, guitar slavedrivers, pitch followers, or with a keyboard. Multiple units can be combined with a guitar controller to form full polyphonic synthesizers at a fraction of the cost normally expected. Combined with a regular synthesizer, it adds an extra "voice" to your present system. Oscillator stability and tracking are the best that state of the art will allow. Numerous inputs and outputs are available on the front and top of the unit. Other signals available inside can be brought out for special applications, and connected to other equipment in a variety of useful ways.

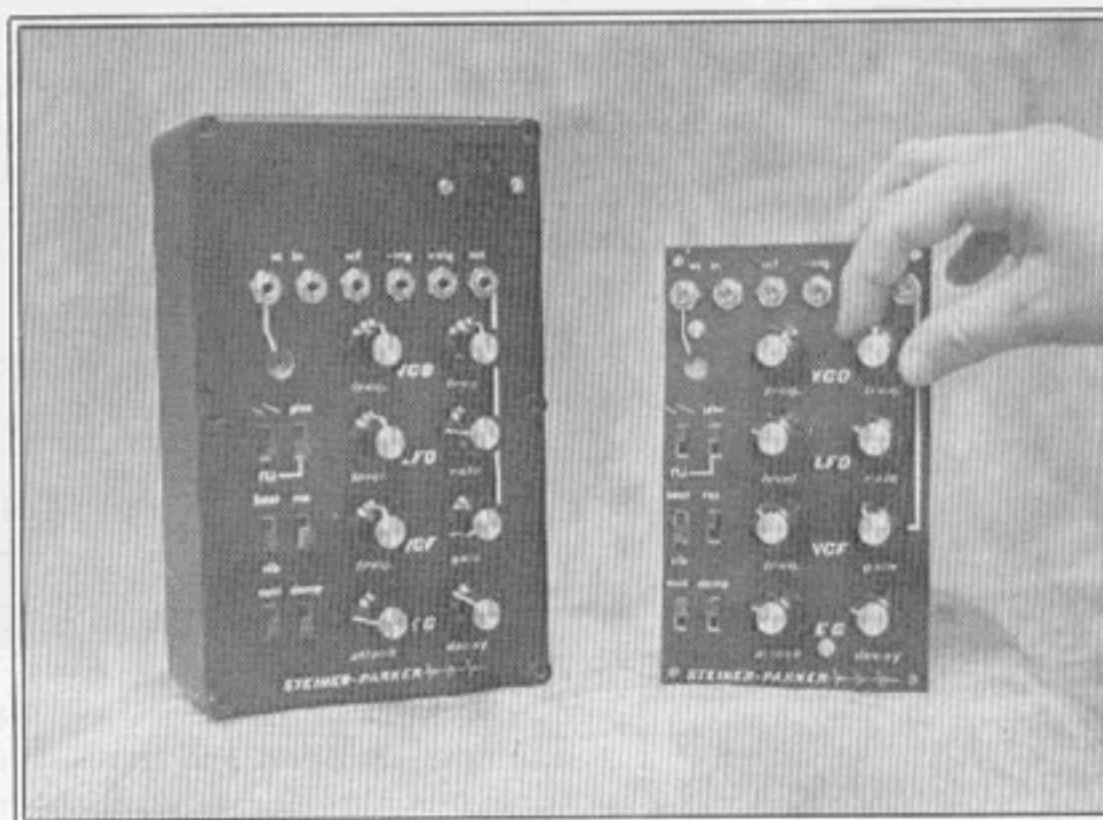

CONTROLS: VCO-course, fine, three waveforms • LFO-level, rate, beat, vibrato • VCF-frequency, gain, resonance • EG-attack, decay, sustain, damp • VCA-trigger controlled audio gate • + and - triggers out • VC filter in • calibrated and uncalibrated VC in • signal out (can be paralleled) • trigger in • beat function-causes the VCO to sound like two oscillators beating together • List \$300.00 •

STEINER-PARKER 2734 So. 2700 WEST, SALT LAKE CITY, UT 84119 (801) 972-1447





## The Dartmouth Digital Synthesizer

Folkways FTS.33442

The four pieces on this record remind me of the electronic music that has come out of the Columbia Princeton Tape Center. There are lots of tone clusters, modulated bleeps, and the silences between events that characterize much of the academic electronic music of the last 20 years.

These pieces, recorded on the Dartmouth Digital Synthesizer, all benefit from the increased timbral control afforded by digital synthesis, and several of the pieces are more tonal than much electronic music of this type.

"Georganna's Farewell," by Jon Appleton, opens with a large minor chord which recurs periodically throughout the piece to separate the atonal episodes in-between.



"Bilder (Images)" by Lars Gunnar Bodin is made up of three sections. They don't really conjure up images for me, but are rather haunting statements nonetheless.

Russell Pinkston's "Emergence" starts off sounding like the beginning of "Star Wars,"

with descending modulated sounds suggesting a battle. This however quickly segues into some spare tone clusters, which give way to some jazz 9th and 11th chords of very short duration. This leads back into the intergalactic battlefield. Pinkston states in the liner notes that he wishes to communicate a sense of emergency, which he does very well. The piece ends with some romantic chords that might be a little corny, but are a good ending for this sci-fi composition.

William Brunson's "Tapestry I" starts with a "crackling fire" that leads to some sounds not unlike a plucked piano. Pretty much standard "Post-serial electronic music" but as in all the pieces, the timbres of the sounds, particularly the metallic ones, are quite appealing.

All in all, an interesting record, although more for the sounds than the music.

—Danny Sofer

## Mother Mallard's Portable Masterpiece Co. Like a Duck to Water

Mother Mallard plays cyclical music similar to that of Terry Riley, Phil Glass, and others. Repeating figures phase rhythmically in and out, over and over, slowly but surely changing over an extended time base. At best, this kind of music is like good dope, uplifting and transporting one through time and space, an experience. At worst, like a sequencer that someone forgot to turn off. "Like a Duck to Water," a title that belies the serious nature of this record, shows off some of the best attributes of the style, but not with-

out a few drawbacks.

"Water Wheel," the opening cut, is an uptempo piece that dances itself to a frenzied climax. This piece is quite agile, all of the lines flying in a rapid triple meter.

"Oleo Strut," is more sombre, its colors receding to the contemplative; a hymn.

The instrumental color is rather bland, because of the predominance of the RMI piano, a dull sound source in any music. The synthesizers are not used very vividly, either, leaving the harmony alone to vary the timbre, which it does adequately.

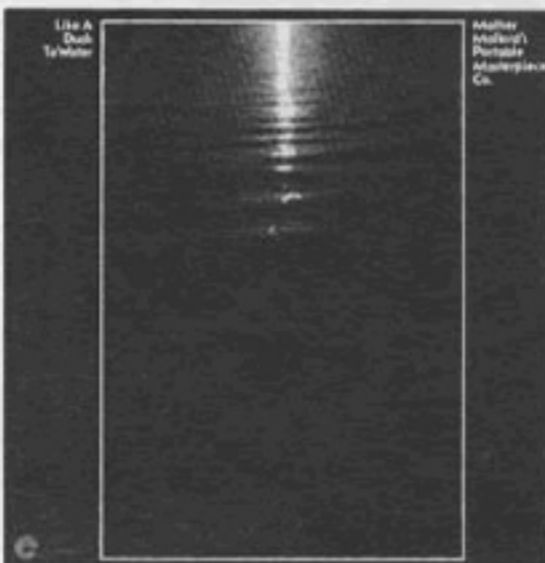

"C.A.G.E pt. II," is a longer work, taking all of side two. This piece strikes me as being overcast; the clouds roll in, the density stays thick; the colors change, but they are all lighter and darker shades of grey.

Actually there is some nice stuff on this record, but it can get boring unless you are in the proper mood. "Like A Duck to Water," and Mother Mallard's first album are available from the New Music Distribution Service, 6 West 95th St., New York.

Danny Sofer

## Book of Dreams Steve Miller Capitol

The space cowboy indeed. Country Rock gasps its last as honchos like Steve Miller spur their Rolands across the range. "Book Of Dreams" prefaces mild, country tinged pop songs with elaborately synthesized intro's, an unlikely but commercial juxtaposition. The reader may recall the most unusual hit single of 1976, Miller's "Fly Like An Eagle", which featured an echo-plexed white noise obligato. While the effect of all this is the same as playing tennis in argyles, it is nonetheless pleasing to hear synthesizers homestead the last



frontier. Those who dug "Fly Like An Eagle" will feel the same about "Book Of Dreams", but snobs who despise blatantly commercial music no matter how well done would be wise to snag a copy of Miller's 1969 classic "Children Of The Future" before it goes out of print.

—Tom Davey

## Tchaikovsky's 1812 Overture and Nutcracker Suite by Larry Alexander and Jack Kraft London Records SPC 21168

Two philosophies are generally prevalent with respect to the realization of orchestral scores, one, the purist approach would submit to a note by note and timbre by timbre realization of



the actual score, the second approach would allow substantial license to the electronic musician making the score's realization largely a matter of infusion and mixture of what the composer wrote and what the synthesizer can do. Perhaps examples of the first approach would include Walter Carlos and Pat Gleeson, while Tomita runs away with the nominations for the second school of thought.

Kraft and Alexander are clearly Tomita's cousins in philosophical thought, after all they purposely set out to realize the scores with synthesizers avail-

turn to page 11



# It's here. The first album by LEM.

# lem



**EVAN CAPLAN-DRUMS & SYNDRUM**  
**ALEX CIMA-SYNTHESIZERS & PIANO**  
**DOUG LYNNER-SYNTHESIZERS**  
**BRYCE ROBBLEY-SYNTHESIZERS & VOCALS**  
**DANNY SOFER-SYNTHESIZERS & DRUMS**  
**JOHN STUBBS-VIOLIN**  
**WAH-WAH WATSON-GUITAR (COURTESY OF  
COLUMBIA RECORDS)**  
**PRODUCED BY BRYCE ROBBLEY**

AVAILABLE AT ALL MUSIC PLUS STORES  
MFG. SUGGESTED LIST PRICE \$7.98

**SEND \$6.95 TO:**  
(CALIFORNIA RESIDENTS  
ADD 6% SALES TAX)

**WAVEFRONT RECORDS**  
8615 SANTA MONICA BOULEVARD  
LOS ANGELES, CALIFORNIA  
90069



# PERFORMANCE

## A Panorama of Electronic Music Friday, May 13, 57th Audio Engineering Society Convention. L.A. Hilton Hotel

On Friday the Thirteenth at 7:30, Barry Schrader presented perhaps the most effective concert of recorded electronic music given in the Los Angeles area in the past few years. Entitled "A Panorama of Electronic Music", the concert included many of the important works recorded throughout the brief history of electronic music, supplemented by slides and explanations by Mr. Schrader of the techniques used.

The most warmly received composition on the program was

Henk Badings's *Capriccio for Violin and Two Soundtracks*, brilliantly performed by Yoko Matsuda, proving once again that performances by live performers in concert are more effective than performances by tape recorders. Ms. Matsuda elegantly mastered the exacting demands of synchronizing her performance with the stereo tape.

Films utilizing electronic music created photographically on the film's sound track were included on the program.

Exercises 4 and 5 by John and James Whitney, abstract films with electronic soundtracks accomplished before the advent of *musique concrète*, were crude but amazing, in contrast to their later works which are not crude, but no less amazing. On the other hand, Norman McLaren's

*Synchromy* was a cute and trite gimmick.

Additional pieces on the program included concrete and tape manipulation pieces: *Two Etudes* by Pierre Schaeffer, an excerpt from *Williams Mix* by John Cage, *Vladimir Ussachevsky's Incantation*, and *Omaggio a Joyce* by Luciano Berio; classical studio compositions: *Study 11* by Stockhausen, and *Ligeti's Articulation*; computer works: an excerpt from *Mutations I* by Jean-Claude Risset, and *Two Speech Songs*, for computer generated speech and singing, by Charles Dodge. Synthesizer works included: *Subotnick's Silver Apples of the Moon*, excerpted, realized on a Buchla 100 Series system and *Dance from Cloudless Sulphur*, using Buchla's 200 Series; *Basilisks* from Barry

Schrader's *Bestiary*, also employing the Buchla 200; and an excerpt from Milton Babbitt's *Occasional Variations*, employing the RCA Mark II Synthesizer.

Ironically, the synthesizer compositions sounded less fresh to this reviewer's jaded electronic ears than the earlier concrete and classical works; nonetheless, all the compositions presented were excellent from both the historical perspective and their musical value, with the exception of the Babbitt piece, which seemed to wander aimlessly and endlessly through serial pitches and rhythms. The program was long (2½ hours) and the density of information was staggering, but the evening was enjoyable and inspiring. Inspiring for tape music, that is.

—Eric Valinsky

## Synapse

**DON'T  
MISS  
OUT**



Avoid unsightly  
subscription lapse!

Your subscription to **Synapse**  
may end with this issue.  
Don't miss out—renew!  
Use the enclosed  
postage-paid subscription envelope  
or send \$6.00/USA or \$7.50/foreign to:

**Synapse-Subscription Renewal**  
2829 Hyans Street  
Los Angeles, California 90026

*LACEM presents the  
1st Annual  
Electronic Music Festival*

*LEM in concert with  
laser visual music by VIEWSIC at the*

MUSIC CENTER  
 **MARK  
TAPER  
FORUM**

135 N. Grand Ave., L.A. 90012 972-7211  
Monday, October 3rd, 1977 8:30 PM

*Tape and live electronics at  
Theatre Vanguard*

9014 Melrose Ave., L.A. 90069 276-9987  
Friday, October 14th, 1977 8:30 PM

*And . . . a soon to be announced  
television production.*

 **LACEM**  
los angeles center  
for electronic music

8615 Santa Monica Blvd., Los Angeles, Ca. 90069



from page 8

able in any musical instrument store (ARP 2600, Odyssey, and Pro-Soloist), shunning exotic and more complicated equipment. Considerable overdubbing was necessary to record the thicker parts of the 1812 Overture.

Many of the instruments are realistically portrayed. The Overture begins with a fade-in of human like voices, and strings slowly panning left-right. Kraft and Alexander achieved a good exploitation of panning, stereo image, and instrument separation, all evident from the first bars. The violin, cello, and bass instruments are very good, and particularly successful in the tutti sections where any timbral cues to the contrary are well masked. Their bass and snare drums are also good. The horns were the more realistic by far, their muted horn timbre was really great.

Occasionally, they dabbled in "silly" electronics such as excessive vibrato, sawtooth wave modulation a-la-birds, but generally with taste, humor, and re-

straint. By now it is clear that the intentions are far from an exact replica of orchestral timbres. The sounds of war are bombastic and better than any heard at the Hollywood Bowl. The finale utilizes church-like and wind chime bells as it slowly fades out.

Even more liberties were taken with the Nutcracker score, the orchestral elements (strings, percussion, and so on) remain very much as traditional timbres but it is in this side that electronics predominates, for example, meowing filter modulations and an everpresent noise generator being filtered and slowly swept. An outstanding celeste appears in the Sugar Plum section, and the fast strings in the Russian Dance will impress most musicians.

Except for the possible overuse of the birds and filtered noise, this record demonstrates unusual musicianship and a successful recording where the mix, ensemble, evidence of noise (hiss), and dynamic range are all clearly up to professional standards.

—Alex Cima

**Synapse**

## ▷ DENNIS The new synthesizer that doesn't need a filter

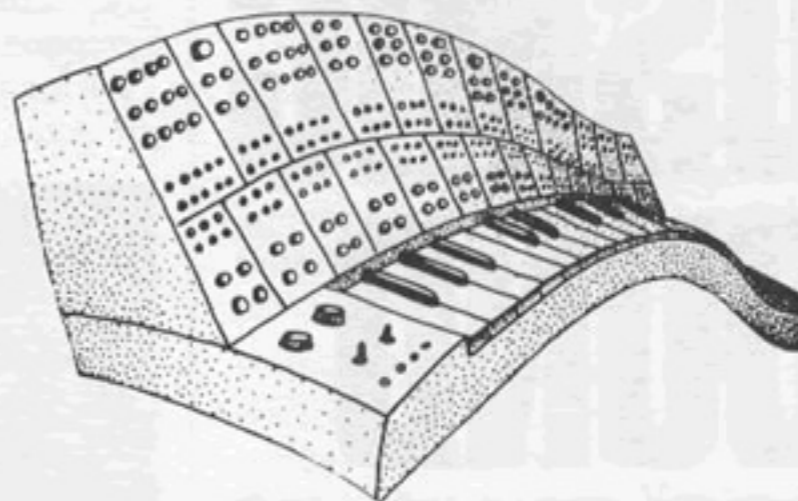

*Our new VCO's have an envelope input that lets you control timbre continuously, from a sine wave to a big fat pulse. This Dynamic Depth FM technique (through 0), which has never before been possible without a computer, provides timbral control like no filter has ever come close to. And, since a typical voice requires only one VCO, one VCA and an Envelope Generator, system costs are reduced to a fraction of what it takes to do things the old way! Write or call for information.*

**Dennis Electronics**

(808) 955-2839

2130 Metcalf St., Honolulu, Hawaii 96822

### FULLY MODULAR STUDIO SYNTHESIZERS

*Available as complete systems, in custom configurations, or as individual modules.*

*Available in kit form with complete documentation and instructions, or as factory assembled and tested units.*

*Compatible with most other synthesizers available today.*

*Write or call today for a copy of our free catalog.*

**ARIES MUSIC inc.**  
po box 3065  
salem, ma. 01970

**(617)-744-2400**





# A COSMIC SOUND GETS DOWN TO EARTH

by Arman Matthews

When hitching in a foreign province, not long ago, and asked by a local to describe the music scene here, "moulting" seemed the only adjective suitable for retrieval. Last decade's organic psychedelia which lifted young from early graves and hurled us all into new orbits, now seems dissipated, redundant, scattered into many tributaries, one form among many searching for that thread which will convert our past into a future. Below the ruffled surface, however, there is new music, new types of musicians, germinating here on the edge of the earth. They are yet too far out to be "in", but may indeed be the standard bearers for that New Culture at decade's end. "Cosmic Sound", for the time being, has enough adhesive quality, as a name, for their product. Those into it speak of "software" instead of "scores" and think more easily in terms of schematics than musical notes. There is a heavy concentration of cosmic sound

musicians in the Bay Area, as one might expect, yet they are beginning to show up everywhere, Pittsburgh, Boston, New York, Germany and France all have notable examples.

The latest arrival of this genre to the Bay Area is a gentleman by the name of Willard Van de Bogart and his group "Ether Ship". The "Ether Ship", formally the "Electric Symphony" have performed around New York for a number of years and have played at the Avant Garde Festival there for the last

arriving in San Francisco, he completed an exhibition of his work with laser beams at the American Cultural Center Exhibition in Paris.

Van de Bogart displays a kind of Apollonian disdain for traditional rock forms that is fairly representative of his brand of musician. "Rock played at 130 decibels jams the mind until the sound controls and thinking is obliterated. Rock with its music and its lyrics, is a last desperate stab at reality, a music of desperation, with its constant bitching at something. It's destructive sound, not con-

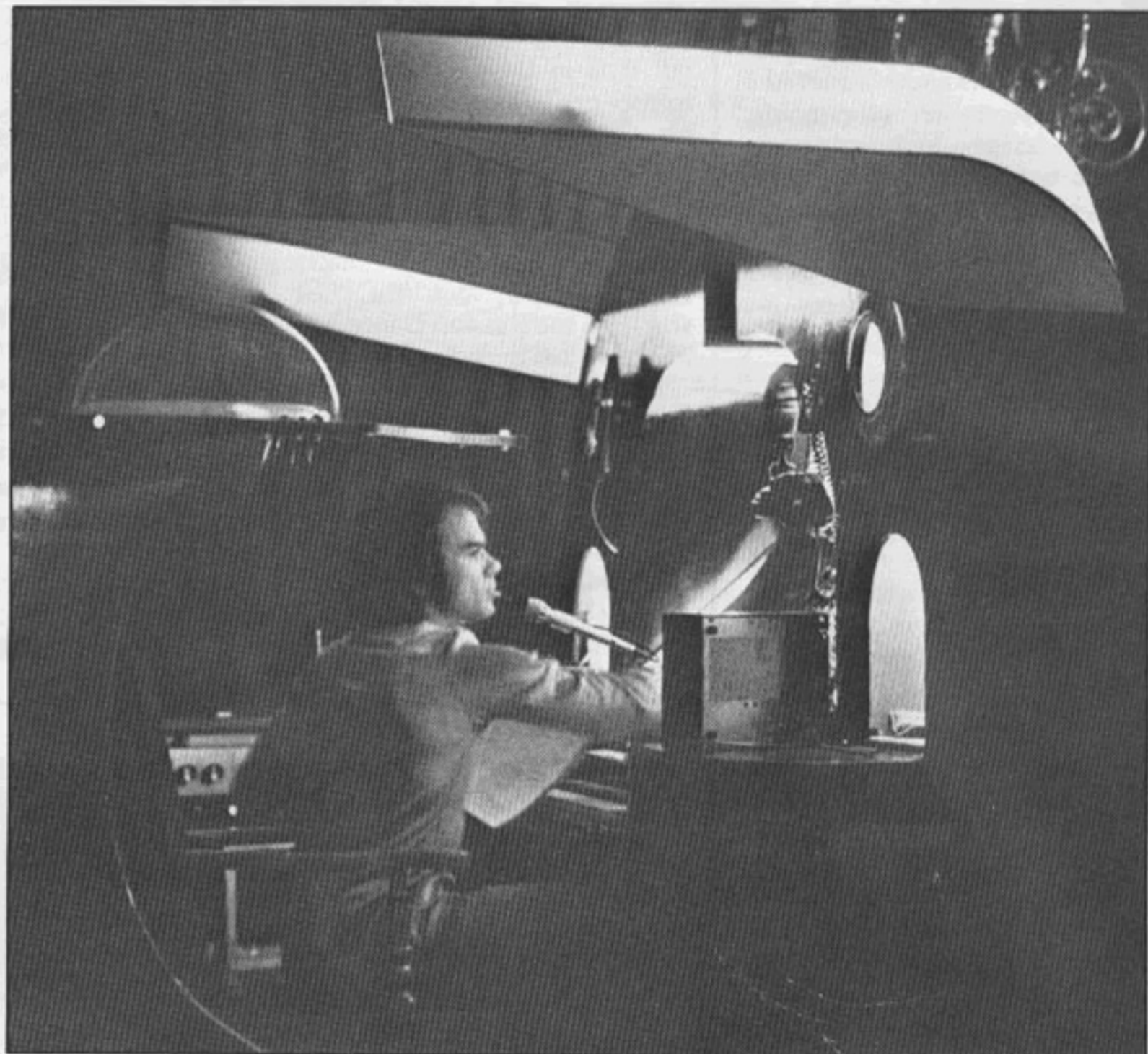

PHOTOGRAPH BY LAWRENCE LAUTERBORN

## Willard Van de Bogart

four years. Born in New York City in 1939, Van de Bogart has accumulated an impressive list of academic and artistic plaudits. He has published twelve articles ranging on everything from "Harmonic Neurons" to "Laser Light In Video Space", B.B.A. from Ohio University, M.F.A. from California Institute of Arts, recipient of A.W. Mellon Award, a Robert Flaherty Scholarship award, founder of Pittsburgh Independent Film Makers, worked with the National Film Board of Canada, taught at the University of Pittsburgh, professor of media ecology at Jersey City State College and has recently taught at the San Francisco Art Institute. In 1966, while working as an editorial assistant at Harcourt Brace and World, an acoustical engineer turned him on to the idea that electronic music could be integrated with art forms. The pyrotechnics of Expo '67 multi-screen projection systems became the final switch sending Bogart rushing on to a new career. Prior to

structive." On stage, however, the Ether Ship appears as freaky as any of its progenitors, yet the set seems more fitting of a Star Trek melodrama than a standard rock ensemble. There is, for instance, the "Intergalactic Communicator", a peculiar oblique with pyramid shaped construction on top (same dimension as the Great Pyramid of Cheops), used for inputs from Lemon DeGeorge's electric harmonica. Van de Bogart appears strapped into his control console surrounded by his "Magnetic Mind Generator", synthesizer, 20 octave control system, reverberating microphone set up (which colors the sound of his voice) and a four-channel color organ with wings on either side. A translucent hemisphere perches over his head functioning as a brain wave analyzer giving audible read-outs of Bogart's wave formations. "I want to hear myself and know that my music is coming from a balanced state of mind", he says, in typical Vulcan fashion. The stage is



set and Bogart begins frantically throwing switches, pushing buttons, turning dials, attempting a lift-off for the audience into different realities. He uses live inputs mixed with traditional electric instruments, tapes, voice chants, color spots and synthesizers. If the energy level of the audience seems to obstruct the flight, he adjusts his music to overcome it "like an airplane pilot having trouble with wind and rain when he flies."

The Ether Ship made its first appearance in the Bay Area at a concert put on by the Esalen Institute, November 3rd, 1976 at the International Student Center in San Francisco. Esalen called it "Concert for a New Age", transformation sounds of music. Playing along with Willard Van de Bogart and Lemon DeGeorge was Selwin Lissack on electric drums and Tibetan Bells, from Johannesburg, South Africa who previously played with John McLaughlin in England.

The reaction of the audience was mixed. "It was like an acid trip played backwards, I was bummed out," reported S. Barrett Williams of the Spectrum Research Institute. Undoubtedly, many ears will feel twinges of doubt after listening to this kind of music. They will miss that melody which takes us above the billiard ball plane of Newtonian physics and the motive power of the beat driving toward a grand finale. Occasionally these things appear, as parts within a whole, yet the urgency, pain and pathos of life seem often times ignored by Apollonian concerns with interesting sounds and plastic forms. There are technolo-

gists of this space music who tend to more closely approximate traditional forms. A group called Plasma Gammit, that I have heard several times, integrate rock with cosmic sound in a way that occasionally approaches the greatness of a Bach fugue. Van de Bogart however, wants to take us beyond music, introduce us to new realities and harmonies of spirit through his electronics. Thus his music seems more concerned with atmosphere than melody. "The main component of the work I do is to create an awareness of another space, another reality, another dimension and another sense of time. I use symbols to create a mental platform by which to project ideas concerning another reality". Van de Bogart uses the term "mindscape" to signify this "platform" on which he wishes to project other dimensions. The mindscape might be beneath the ocean where subtle threads of electronic sound comingle with the eerie deep throated gap of whales, or a supernatural terrain of potential horror might be projected for the audience. The capacity of this kind of music to reach the bizarre, the ineffable, seems unlimited. On New Years day, I heard a piece by Will Jackson, and Stefan Weisser, other noteworthys of this breed, of the cosmic group "To", in which electronics mixed with an Indian peyote chant as background to a tape played backwards of a recitation of the late Artaud in his maddest moments.

What is the point of it all? There is a firm conviction shared by Willard and his col-

leagues that they are taking part in a transformation process of the human race. Bogart believes that in detaching his audience's minds from their ordinary sensory world and leading them on psychic trips over uncharted dimensions, he is introducing subtle changes in the structure of their minds which could not be done via ordinary information inputs.

"The creative mind of Man has now evolved to the point whereby it can participate in the evolutionary growth process of the mind. The higher functions of Man's mind is mentally mutating to the point where complex light and sound patterning will serve as a major resonant experience for mental stimulation."

Within the interaction of laser light and electronic sounds, he sees a higher order of mental functioning evolve. Clearly, cosmic music artists such as Van de Bogart see themselves not only as musicians, but as engineers working alongside parapsychologists, U.F.O.ologists, seaologists and the whole consciousness movement to accomplish a transformation of our species a la 2001.

Willard Van De Bogart and his colleagues probably have the right ball of yarn, although maybe not the exact thread. They are in process, at first groping, grasping, experimenting, now refining today for tomorrow. They see, as the end of this process, not merely another slick market item like disco, but new feathers for a moulting bird, no less than the ascendance of our race into the intergalactic community. ~~~~

## Synapse

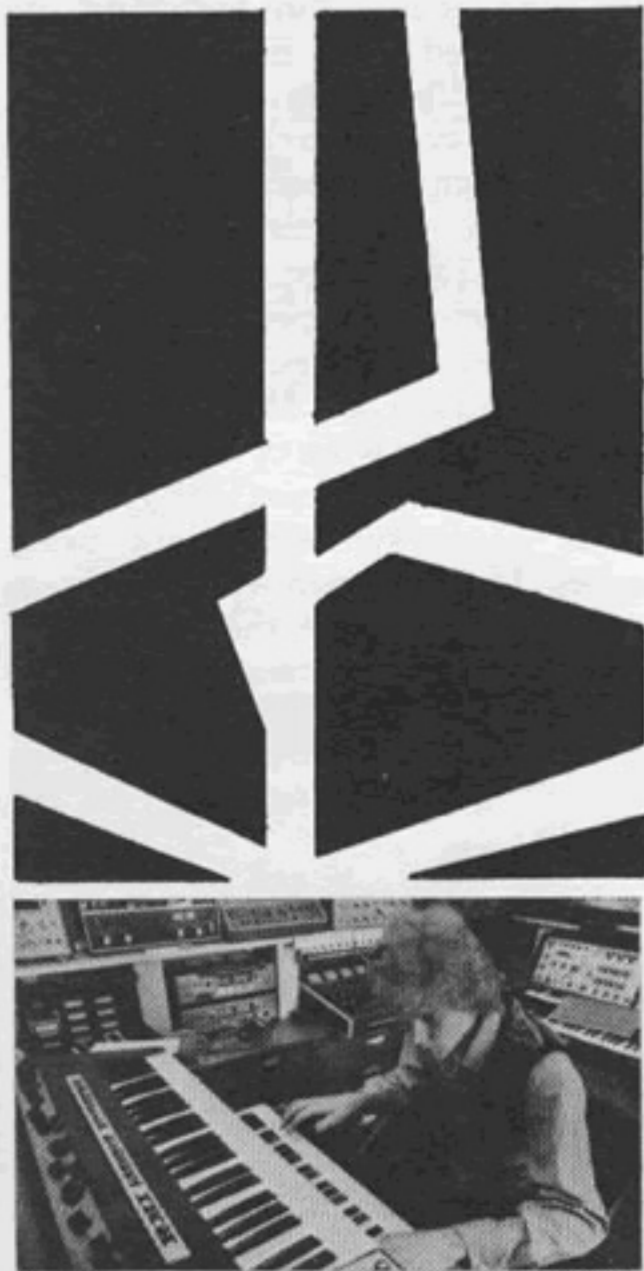

**the Boston School of Electronic Music**  
326 Dartmouth Street, Boston, Massachusetts 02116

**The FIRST Independent School of  
Electronic Music Still Providing  
More Individual Lab and Studio  
Time Than Any Other EM School.**

**Fall Semester Sept. 6 - Dec. 9**  
**Call or Write for our Catalog**  
**617-261-1634**



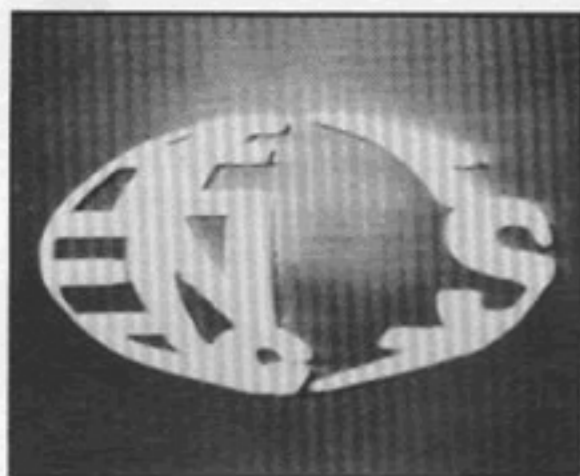

PHOTOGRAPHS BY ARLENE KORETSKY

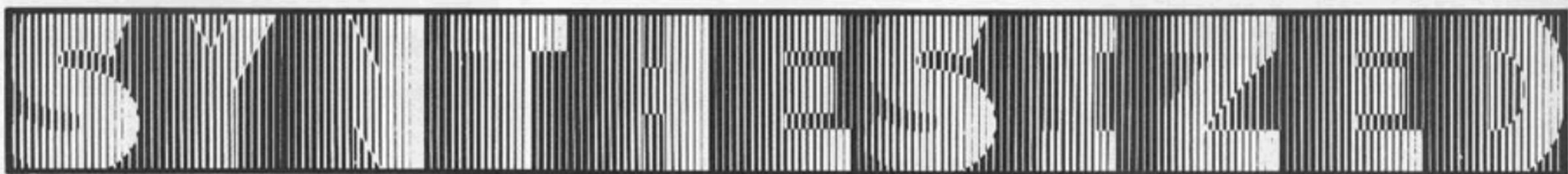

# WOODBO

*What Robert Moog and Donald Buchla did for audio in the sixties, Steve Rutt did for video in the seventies. Rutt designed the first coherent, relatively low cost synthesizer. He created a kind of electronic animation capable of modifying an image from a camera and of generating an abstract image without a camera. The Rutt-Etra [RE] synthesizer is in many ways parallel to an audio synthesizer, and it is not difficult for a person who knows sound synthesis to familiarize himself with this new technology. Both devices are real time, voltage controlled systems, and they share many of the same control voltage generators.*

by Randy Cohen

The Rutt-Etra developed out of a collaboration between an engineer, Steve Rutt, and an artist, Bill Etra, much as the original Buchla system was influenced by the interaction between Don Buchla and composer Morton Subotnick. Etra's studies had ranged from bio-physics, through the various stage crafts, to still photography, to film documentary work. The film work lead him to docu-

mentary work using portable video gear. His breakthrough came when he turned the video camera to face its own monitor and discovered the joys of video feed-back. This excited Etra about the possibilities of video art. Steve Rutt grew up as a classic American basement kid, building amplifiers and mixers



PHOTOGRAPH BY ARLENE KORETSKY

Steve Rutt

before he entered the sixth grade. His interest in audio engineering reached its zenith at the Yip-In in Central Park in 1968. Rutt did all of the sound work for this cultural high-water, running all of his gear from a 3,000 watt generator in his car.

When these two began their partnership, Rutt was occupied designing industrial electronics, building control gear to monitor the passage of coal down the chutes, dummy tv

cameras for department store security, and gigantic strobe lights used to check details in the manufacturing of steel. Etra was working in the experimental tv lab of WNET in New York, spending much of his time using the Paik-Abbe synthesizer, and becoming increasingly frustrated by its limitations. Etra received some funding from David Loxton, the director of the tv lab, to collaborate with Rutt on the design and construction of a device that would overcome many of the limitations of the Paik-Abbe machine.

The system they developed drew on the advances made by other designers. In addition to Nam June Paik and Shue Abbe, they were influenced by the work of Ben Lapasky, the genius of Cherokee, Iowa, who, in the 1940's, was doing synthesis work using oscilloscopes. Etra also mentioned the Ernie Kovacs show, which gave the first public



PHOTOGRAPH BY LOUISE ETRA

Bill Etra



exposure to modified video images.

Since the video signal and the information it carries are far more complex than audio transmission, they were faced with a vast array of problems. Also, Etra emphasizes that the body of video technology was built to record the real world, and not to alter that imagery. He adds that television technology developed out of radio and tended to discourage the techniques of the film world.

As an artist, Etra was particularly pleased that they were able to develop a real time system. This was a radical development, unavailable in film, animation, or computer work, and it placed the artist in a new and attractive position. Less desirable were the economics of the Rutt-Etra system. Although it costs a fraction of any comparable system, it is still expensive technology. Etra estimates the cost of his own studio, built around the RE and including many peripherals, at over \$40,000. This put great limitations on the numbers of people who would have access to this field, and influenced the ultimate resting place for the machines. Rutt has built systems for WNET in New York, EUE Screengems, the Media Studies Center of the State University of New York at Buffalo, the Art Institute of Chicago, Ontario College of Art, and studios in Venezuela and Australia.

---

“ Wherever  
logos  
lurch  
across the screen,  
chances are that  
Rutt will be  
in the background  
somewhere,  
usually  
giggling . . . ”

---

Bill Etra now devotes his time to the art and not the technology of video. His studio includes, in addition to the RE, the Hearn synthesizer, another voltage controlled machine that performs colorizing functions on the RE's monochrome image, as well as switching, mixing, and keying. Etra has added digital equipment, employing it in a manner similar to that used in many electronic music studios. These small computers, an Altair 8000 and a PDP 11, provide control information to the analog equipment. The studio also contains various peripherals, including a programmable Techtronics scope, cameras, monitors, and tape decks. Etra's

ease and sophistication as he moves from synthesizer to computer console, to tape deck, make one forget the elaborate technology he is handling. He plays with these toys in the best sense, obviously enjoying his work as he spins out image after image, bathing the eyes in color.

Steve Rutt entered into their partnership with an attitude of “We just build 'em; we don't fly 'em”, but his current work, at EUE Screengems, has been creating images, and not designing hardware. Electronic music became prominent in commercials because it provided an economical way to create novel, easily recognized sounds, and Rutt has found a similar situation for his video images. He synthesized fleas and ticks to be dispelled by the Hartz Mountain collar. He warped the image of Dick Martin for a G.E. television spot and sent a stream of words down the tubes for Drano. The titles for the news program in the film *Network* are a Rutt job, as is the new logo for *The Edge Of Night*. When

he was called upon to synthesize the dreaded cough control center for Vicks, the ad agency had three doctors in attendance to assure biological accuracy. He has done in-house work for the Merrill Lynch video network and Atlantic records. He created the abstract imagery for Ophelia's mad scene in the mercifully short lived *Rockaby Hamlet*. These images were transferred from video to film and then projected against a curtain of dry ice smoke, on Broadway. In fact, where ever logos lurch across the screen, chances are that Rutt will be in the background somewhere, usually giggling.

Rutt is presently interested in getting back to design work and is soliciting comments from users of his synthesizer to guide him in designing new video gear. His immediate project is the Image Repositioner, marketed by the Professional Video Group. This device can isolate any portion of a tv image, even if it is already recorded on tape, and move it to any new spot on the screen.

---

### The Rutt-Etra Video Synthesizer

---

A tv image is built up out of a set of parallel horizontal lines, called the raster, that scan across the screen. The Rutt-Etra can deflect the raster to reconstruct an image. The original image enters the RE on the *Display Unit* and is altered via the functions provided on the *Display Control Unit* (DCU). The DCU offers both manual and voltage controlled manipulation of height, width, depth, intensity, and horizontal and vertical centers. The control voltage functions are housed in the *Animation Module*. The final image is shown on a *High Resolution Display* where it is then shot with a camera and treated as an ordinary video signal. The RE is a monochromatic system; color and other effects are added later. The control voltage generators in this machine can be augmented or replaced by those found in many audio synthesizers. The RE also can be interfaced with digital equipment.

---

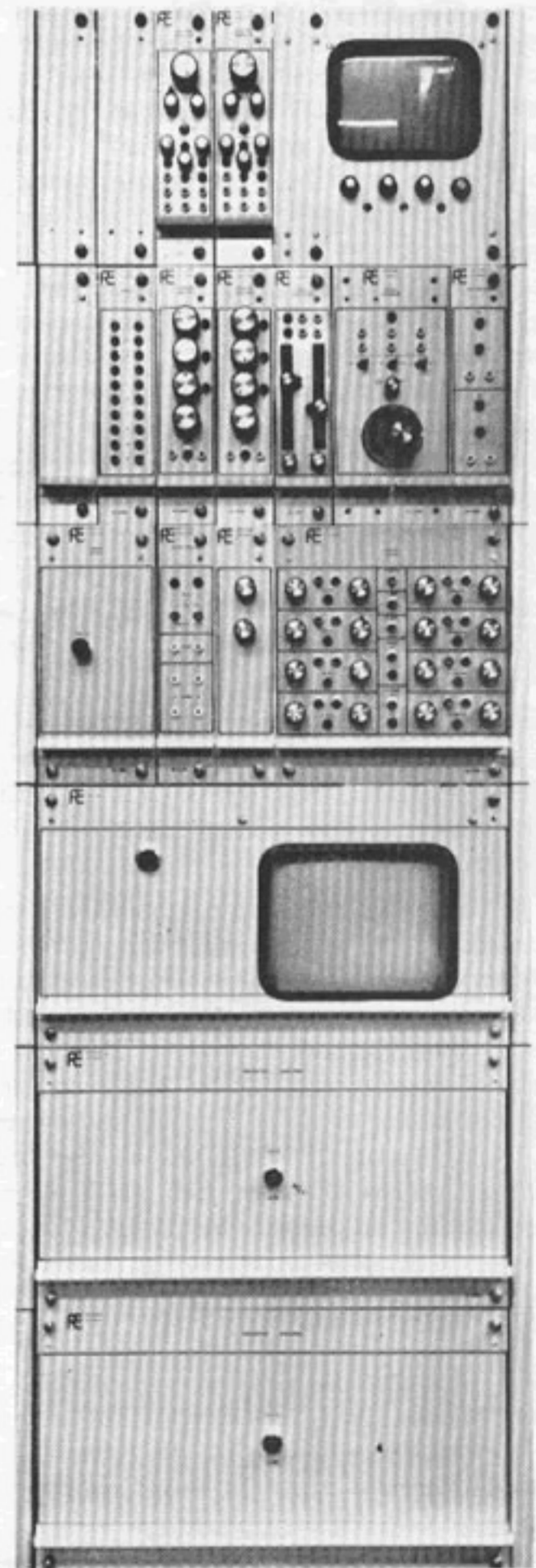



## Part Two: Heavy Users

If technically video synthesis parallels electronic music, artistically the parallel breaks down. Listening is very different from looking. Not only is visual information more complex than audio, the problems of form, change over time, transition, and detail are also very different. Visual imagery is embodied with a different set of connotations than is musical imagery. Visual work draws on a narrative tradition that is alien to music. One conceptualizes visual events in a manner quite unlike the experience of listening to music. Thus, visual synthesis does not create a sort of electronic music for the eyes. There can be no visual equivalent to *Hymen*, nor is there any simple musical translation of a tape by Nam June Paik. And the set of visual problems is approached in a unique way by each video artist.

Steve Rutt suggests that much of the best work with his machine treats video synthesis as only a single element of a piece, much as lighting and set designs are only single elements in a theatrical work. The sculptor, Doris Chase, takes a similar view, saying: "I use video as one of my tools, not as *the* tool. When I have a form I want to go further with, I take it to the machine." She creates work in wood, metal and fiber glass, and she sometimes incorporates her sculptures in films, dance works, and video tapes. Regardless of the media used to manifest her ideas, her work carries an integrity and a unity that evidences a powerful artistic vision across the media she employs. It is clearly Ms. Chase in control, not the machines. She does not get seduced by the technology. She describes her approach to video, saying: "I approach the screen as a painter, and work in a plastic manner, treating the edge of the screen as though it were the frame of a moving painting."

Tom DeWitt draws on a background in film, and a familiarity with audio synthesis. He is particularly enthusiastic about the relationship between electronic music and synthesized video:

"The Rutt system is an analog voltage controlled device and shares many common characteristics with a Moog, Buchla, etc. It might be held in disdain by digital nuts, but I have always felt that an analog is worth a thousand calculations. Many of the control functions used in audio synthesis can be used to generate pictures. For example, the harmonic structures of music can be designed according to polar co-ordinates in positioning an image on the screen. Incidentally, Rutt's box is still one of the best ways to perform repositioning and is becoming a tool for titling in many studios."

DeWitt uses the RE as a single element in very elaborate works. He displays great technical sophistication and is yet another in the current crop of artist-builders.

Most video artists emphasize the newness of this medium, pointing out that it is very

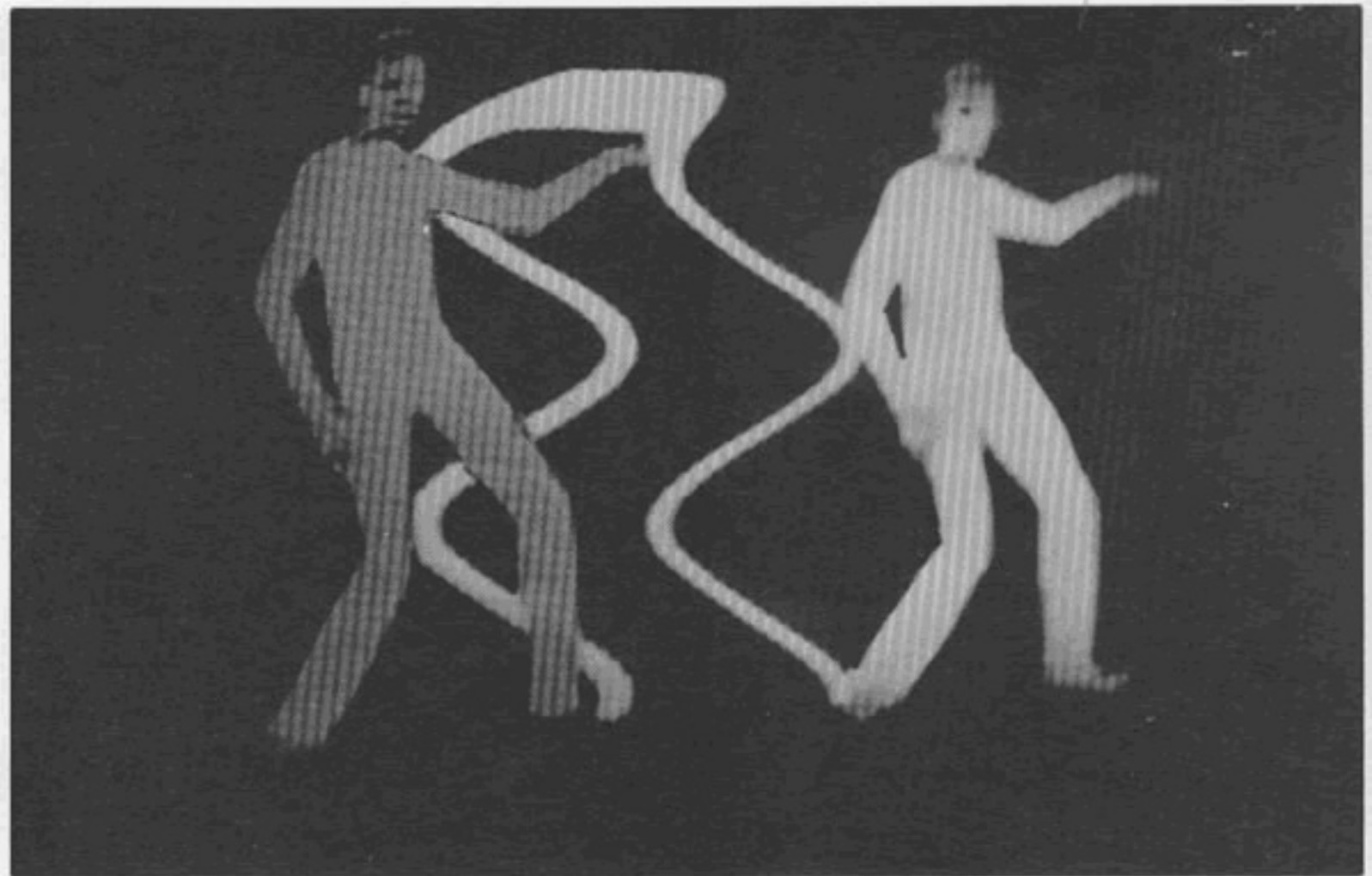

Above: From Doris Chase's "Dance Nine", dancer: Gus Solomon.

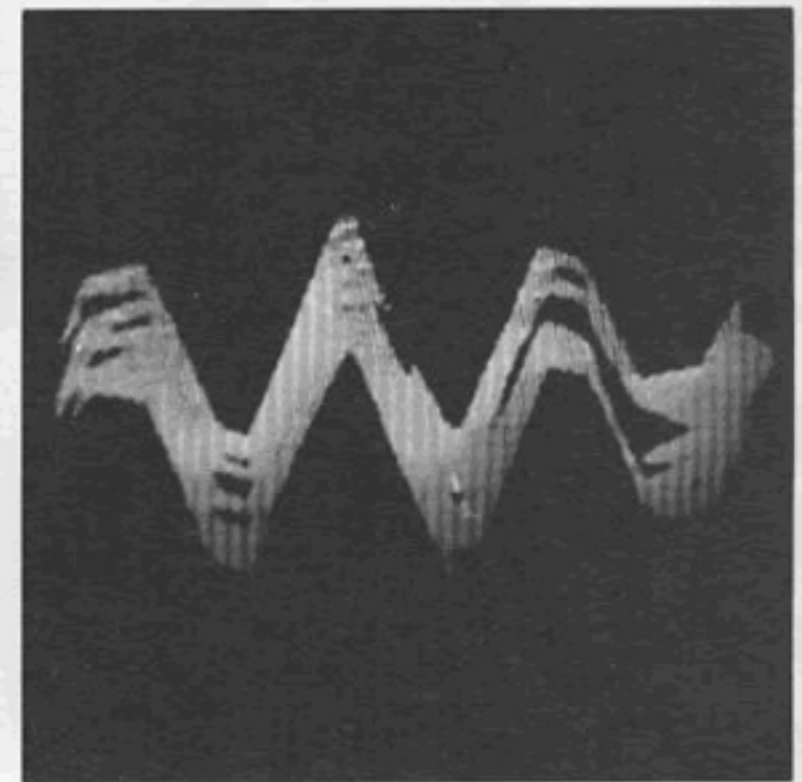
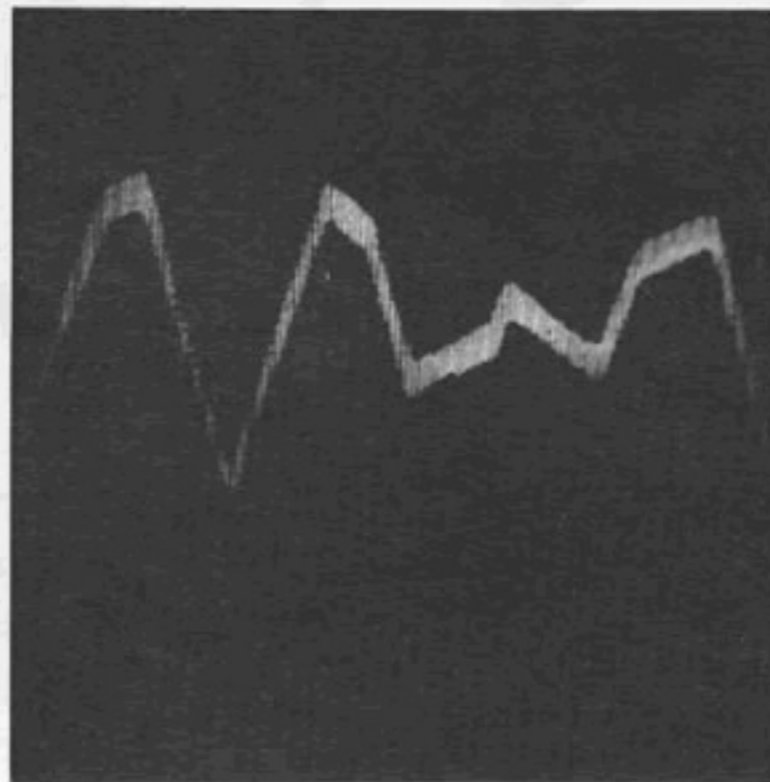

“ . . . Much of the work we do will  
 . . . . this should be a period of great

much in its formative stages. While music has a tradition stretching back thousands of years, the visual artist has only been able to work with images in motion for, at most, the last fifty years. Bill Etra stresses that the individual artists have had synthesizers for only the last six or seven years, while a contemporary musician may have been working with his instrument for decades. Video artist Laurie Spiegel notes the small number of people in the field and looks forward to the time when the machines will have become sufficiently inexpensive and decentralized to create a body of amateur artists working in their homes. She hopes to see the video synthesizer become as common as the piano in the parlor. However, this argument: "It's only in its primitive stages", must be viewed with a certain skepticism. The composers of ancient India did not view their own work as primitive, and neither did their audience. Mozart did not comment on his

own work: "It ain't bad for primitive work, but once everybody gets at these new pianos, we'll get the really hot stuff, like Beethoven." Ultimately, the work of the present generation of video artists must be evaluated on its own merits, and not simply as the precursors of the next century's really good work.

The most charming thing about video synthesis may be its ability to place flickering light inside of a box in the living room, an effect previously unique to the fireplace. One can gaze into this hearth of the future and let the mind wander. Etra refers to certain of his works as "video wall paper" in the manner of Satie, and Nam June Paik has base a witty and insightful installation on the coincidence between tv sets and aquariums. These ideas suggest that *Charlie's Angels* could be replaced by tropical fish, *Police Woman* by an oven with a glass door, and Johnny Carson by a washer-dryer. The ultimate video work might well be a tape of a crackling fire



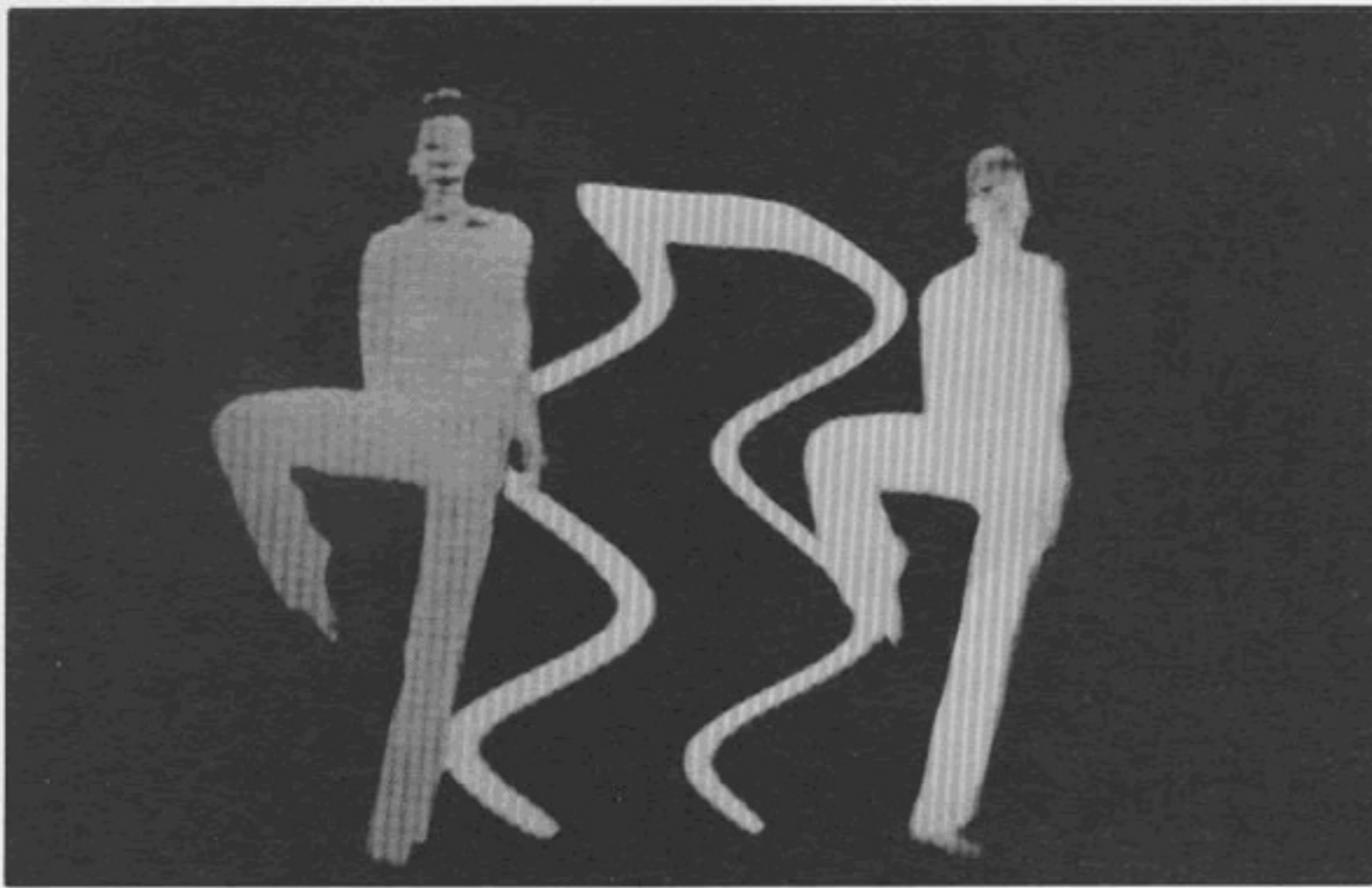

PHOTOGRAPHS BY JAMIE NEWMAN

Below: A section from the Merrill Lynch Video Network logo.

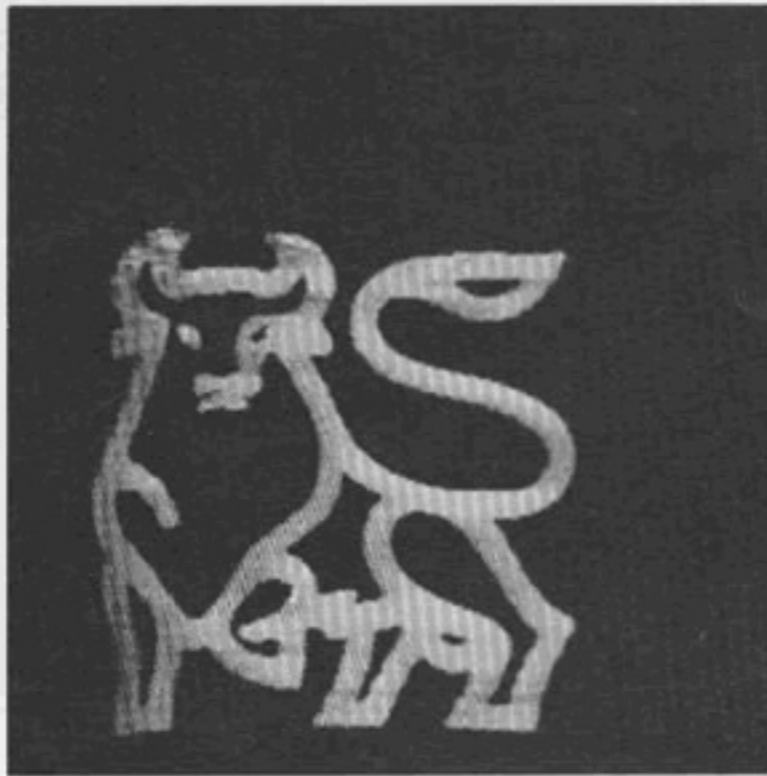
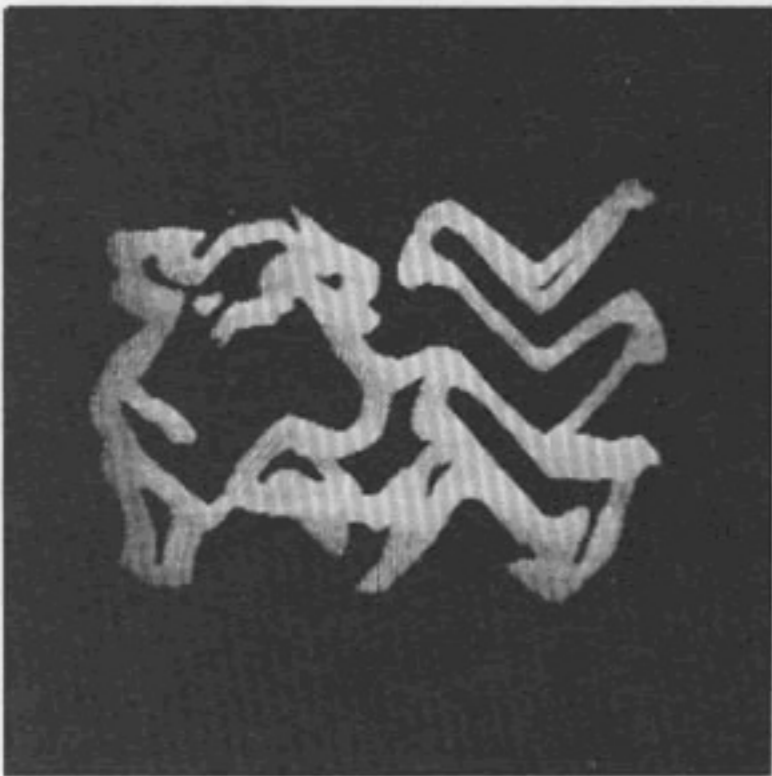

PHOTOGRAPHS BY ARLENE KORETSKY

take instruction from musical ideas. . . .  
cross fertilization between the arts. . . ."

displayed on a monitor that is placed in a fireplace and set ablaze, and then taped and shown on a second monitor, itself placed in yet another fireplace and set aflame, and then taped. . . .

Video synthesis has vast potential to become the ultimate video game, more exciting than Pong, more breath-taking than Death Race, more elaborate than Space War. For the first time, the home audience could re-assert control over their tv sets, striking back at the networks. They could raul Mary Tyler Moore, twist Tom Snyder, or turn Howard Cosell into a quivering mass of idiot globules, just like the networks do.

Since broadcast television has not been overly responsive to the works of a Doris Chase or a Bill Etra, video artists have been facing a distribution problem even more severe than that of the contemporary composer. The new video discs may create a wider audience for these people, but that is in the

future. The current conditions of the field are those of continuing research and experimentation, both technically and artistically. Tom DeWitt praises the contribution of Steve Rutt, whom he refers to as the "most unusual engineer in video-land", and the "continuing innovation of his former partner, Bill Etra." DeWitt assesses the present situation:

"We filmmakers, video artists and computer graphics freaks are just getting into the realm of time change, something that musicians know about from the beginning of their studies. It is an exciting development in visual art to include change. Much of the work we do will take instruction from musical ideas, and it is not surprising to find that initially we are working quite well in music studios. I have lashed my Rutt display up to a Moog, Serge, EMu, Aries, and computers programmed for music with great results. This should be a period of great cross fertilization between the arts." ~~~~

**Synapse**

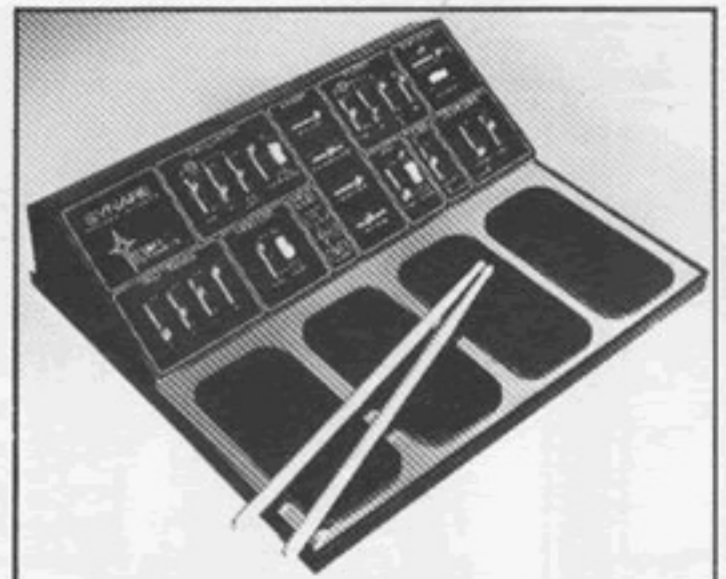

## SYNARE P.S. electrifies the drummer

The innovative SYNARE™ Percussion Synthesizer puts crashing ocean waves, sirens, cocoanuts, chimes, brake drums . . . under your sticks. Designed for use with or without a drum set, the Synare P. S. is played with sticks like a drum, has bounce, and requires only a conventional sound system. Suggested retail \$795.00

Write for information and nearest dealer.



**STAR INSTRUMENTS INC.**  
Dept. S, P.O. Box 71  
Stafford Springs, CT 06076  
Tel. (203) 684-4421

**For Immediate  
Delivery  
of**

**audio accessories**



Send for our **FREE CATALOG!**

**CALIFORNIA SWITCH & SIGNAL**  
A complete line of audio accessories  
OEM Prices • Immediate Delivery  
13717 S. Normandie Ave., Gardena,  
California 90249 (213) 770-2330



# TANGERINE

# DREAM

Tangerine Dream's recent U.S. tour may in many ways be observed as a test. The question would be, can an electronic music group haul themselves, their equipment, a laser set-up, and a laserist around the country to halls seating 1500 to 5000 people and return home solvent? The answer is yes. In fact, most dates were sold out. Of course it helps to have many albums out and ads in the national music press announcing the tour schedule, but nevertheless, it's never quite been done before.

by Doug Lynner

**Doug Lynner:** *I understand that Tangerine Dream originally started from a much more traditional "rock band" format. Would you comment on your beginnings and how you became identified with synthesizers?*

**Edgar Froese:** Well, the thing was that we felt we couldn't do our music just playing drums and guitars. We had something different in mind and with conventional instruments we felt we couldn't do it because of the limited range of sounds. And so there was coming up the possibility to use synthesizers and instruments that allow you to collect sounds the way you want, not just given sounds from conventional instruments. We started in a very small way with just a little synthesizer first and through the years we were able to try bigger ones and more expensive ones and try different possibilities.

**Doug:** *Were there any groups or people that influenced your move to synthesizers?*

**Edgar:** No group.

**Chris Franke:** No, we actually got the first stuff in Germany because we were in the process of extending our instruments. Conventional instruments are just not enough. Actually, we started using synthesizers, not because they were around and something new, but we thought we had the knowledge and the theory to do much more than just make sound effects. We want to be an explorer in sound.

**Peter Baumann:** The electronics were just a

result of other things we were doing to make sound. Electronics were a result of that because it was more easy to handle and more universal, even in Germany.

**Doug:** *Is the introduction of keyboards part of your attempt to be accessible to a popular audience?*

**Peter:** It doesn't happen by the thought that we want to sell a million albums. Of course we want to sell it, but it comes after the musical development. First there was the musical development of going very far away from what was usual to us. We had to make a very, very big circle to be able to express ourselves in a language that is understandable. That's why we had to make this change.

**Doug:** *Language is something that I am interested to talk to you about. So far, you've not been doing vocals. Do you plan to use them in the future?*

**Edgar:** We may use them but definitely not in the normal way.

One thing is that we are from Germany and what we could say in English is not that understandable so why should we sing in bad English?

**Peter:** Another thing is that singing has a very direct association and the music we are doing leaves very much space for interpretation. People have different access to the music. I think for instance, with Rod Stewart, there are not very many different ways to access. There is only one. Using the voice with special fixed lyrics would limit

that very much. We might do it one day for a special purpose. We would use the voice as another instrument or sound source.

**Doug:** *What kind of response did you get from American audiences on your trip?*

**Peter:** Very good.

**Doug:** *Did they seem open to your music?*

**Peter:** I think you can't say it that easily. It's very difficult to distinguish. Some people say our electronic music is chance. We realized, especially yesterday, (Santa Monica Civic Concert) that once you have a good relationship to the audience you are able to go really very far out and play things that under normal circumstances they would never accept. But just because you have a good correspondence, they are listening to you. They accept you and they accept what you have to say. They have a feeling for whether you're standing to what you are saying or if you are not. And if you are, they like it.

**Doug:** *From a live performance viewpoint, what directions do you think that synthesizer designers should work in?*

**Edgar:** A lot of instruments are very unuseable because the design and the way of handling the instrument is totally senseless. A lot of times we've bought an instrument with little knobs you can't find or switches you can't find.

**Chris:** There are three aspects which have to be dealt with very fast. Programming; changing programs in performance, which





PHOTOGRAPHS BY BILL MATTHIAS

## Peter Baumann, Edgar Froese, Chris Franke

can be done—the aspect of new sound possibilities; much more control over things you've got with conventional sounds; much more happens in a conventional sound—and the third point is the actual physical control; there needs to be much more than just playing on a keyboard or knobs and switches.

**Peter:** I think the attitude of the musicians towards the music and the use of electronic instruments is a very important part for

designing future instruments. There is a difference between some African tribe hitting a drum and the people of the civilized world playing synthesizer. There is definitely a difference. I think we're just very much at the beginning of realizing what electronic music is all about and what it can be about. It's still a very unknown land. I'm not sure presently about the future but I think one has to distinguish very much between playing these things very emotionally or very much

by thought about it. And this is a reflection of how things have to be designed. If they should be emotionally played they have to be regarded to be played physically and on the other hand if you want to do the music by thought then they have to be very accurate. Every musician for himself has to decide what he wants to use the electronics for. I think it is yet a very neutral instrument.

**Doug:** *The subject of controllers is very interesting. So far the tradition has been*



# TANGERINE DREAM

keyboard control but now there are starting to be many possibilities.

**Chris:** There are things already like a flute controller, guitar controller . . .

**Peter:** But still this is all coming from the roots of musicians playing instruments but if you really extend the thought about electronic music and the possibilities to play it, then even an architect could do electronic music. It's just a matter of definition. It's not anymore playing drums. It's something else. You have to define very much what a musician is and what creativity is when you get into electronic music.

**Edgar:** The instruments could be much more in the future but it's up to the musicians. It seems that if they are successful or really in the top 30, they are not interested anymore in developing things. They're interested in collecting money more than things they really can do.

**Peter:** You have to take the border very slowly. If you go fast, then nobody can follow you and you will get into borders where you think about things that nobody else but yourself, and hardly yourself, will understand. I have done this and there is no reason to do this. It will happen very slowly and very progressively but very fundamentally and that's why I'm so sure that electronics will be part of future society.

**Edgar:** But if we go too far, we will have only one chance to communicate. There are not too many people with the knowledge so we have to go slow.

**Doug:** *On your tour, laser was featured. Was the laser integrally related to the music?*

**Peter:** It was in parts. Maybe it was less successful than it could have been but it can't be completely successful because we have worked together for six years and still there are minor parts of concerts that are not together. Laserium and Richard Vanceunbrouck-Werth (laserist) we knew for hours or for weeks, and since we are improvising and he is improvising there is only a vague chance that it works 100%. We are happy it worked out as well as it did and we are looking for other things for future tours.

**Chris:** It's a matter of availability. Laser is the last development. It's the best that could be done for us.

**Edgar:** It was an experience for them (Laserium) as well. What they're doing around America is a fixed program and they've mixed the music beforehand so everything is set up. They have never just sat behind their equipment and combined the

light with anyone's music. So nobody knows exactly what will happen in the next second. I think they've done a quite good job of it.

**Chris:** There are better things out like computer graphics and holographs but those are studio productions. It's not a live situation.

**Peter:** And that's a basic idea of our group. There are two opposite worlds. You can put on a record and for every second you know

that this tone will happen and this tone will happen and you can control it completely. The opposite is that you bring three people from different ends of the world, put them together and say, "do what ever you want to do." Tangerine Dream is exactly in the middle. We know each other and we know what we are doing; we are doing music but we have not written scores. By this way of improvisation we have the chance, of course,

PHOTOGRAPH BY BILL MATTHIAS

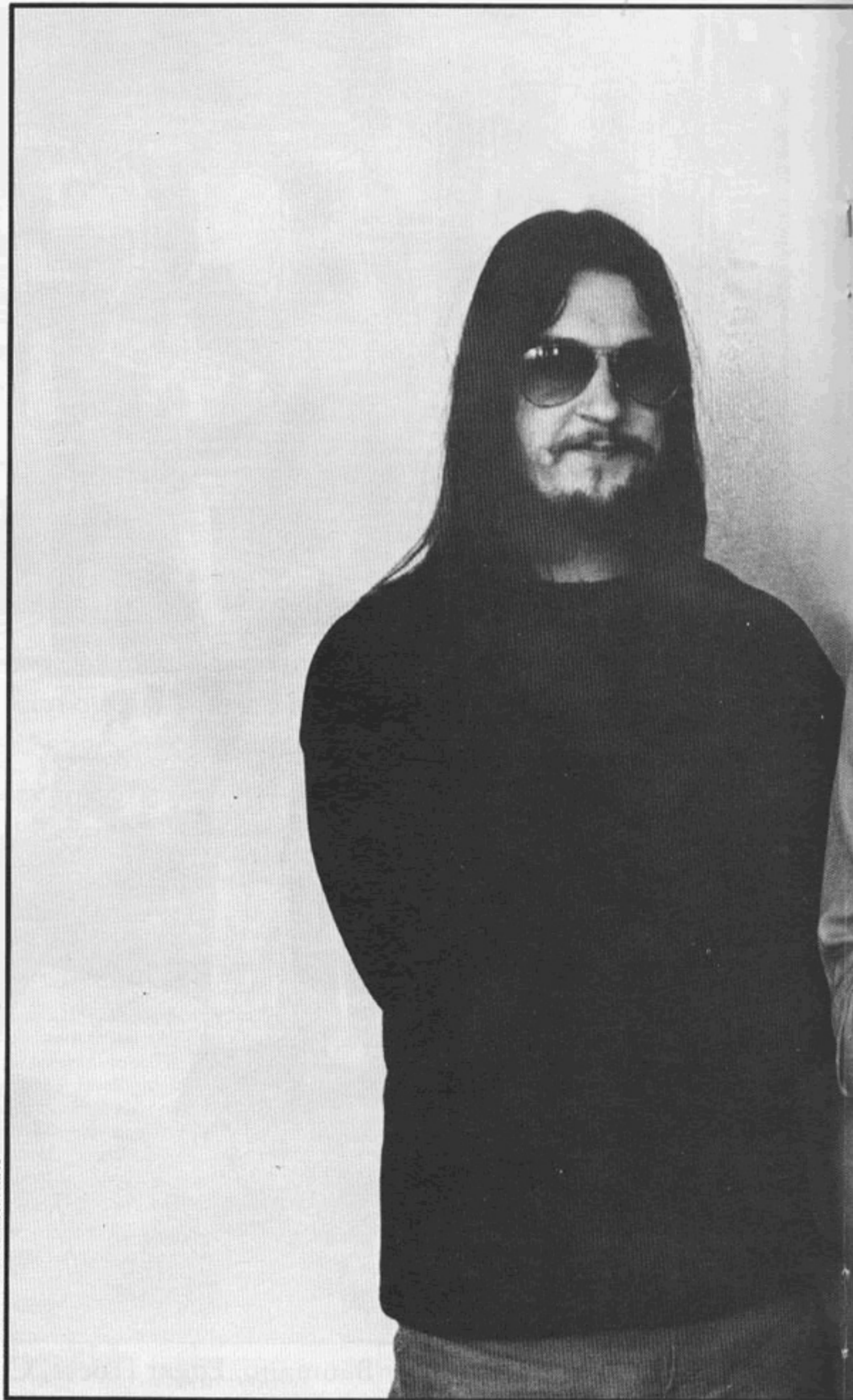



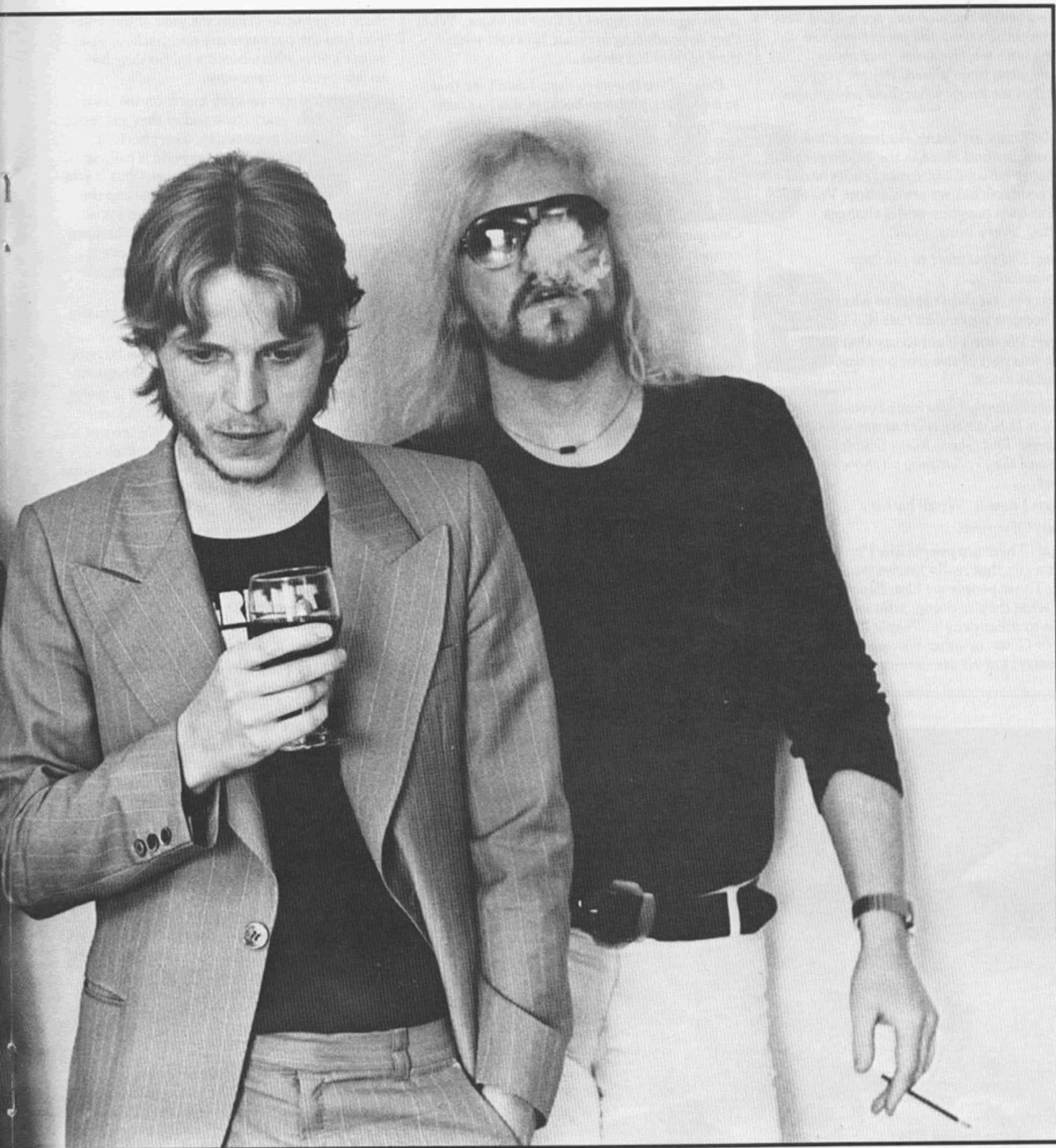

that it can breakdown but it can't break down completely because we know each other, we know the instruments and we know what we are doing. But still we have the kind of improvisation that brings us to possibilities of music. For instance, in the concerts we didn't know what to expect but we knew it couldn't breakdown. That's why we like improvisation very much—because it extends the boundaries.

**Doug:** *At what point do you think it all stops being improvisation? You've played with each other for six years so I'm sure you have some idea what each other will play.*

**Peter:** This could never stop even if you play with yourself. Because you're never stuck in yourself. Everyday you're getting new impressions and you're never ever able to express yourself in one unique setting because you are not God. You are not a

complete extraction of all the life. You are in a special situation and you have a special feeling to what you are doing at that moment. An interview is the same thing. You can ask the same question but I will have a different feeling everyday for this question. And that's what music is all about. Even if you are alone, improvisation will be different everyday. The thing is you don't want to have improvisation everyday. It's very good



to have a group because you are getting very new stimulation from the people you are working with which causes your own improvisation to go ahead. We are very happy that we know what these advantages are.

**Chris:** There are many electronic musicians just sitting around alone in the studio with a lot of tapes who get quite nice results and sound products but we are a group. We all have our own program and it changes everyday, every hour.

**Doug:** *Did you react to the laser performance?*

**Peter:** No, we didn't react to what he was doing because we couldn't see it.

**Edgar:** We don't want to say that the laserist was part of the group or that it was planned as a unit.

**Doug:** *Recently there have been articles in the major U.S. newspapers about yourselves, Kraftwerk, Phil Glass, Klaus Schultz and others and they're lumping all those people together. . . .*

**Edgar:** I hate it. We all hate it.

**Peter:** Of course.

**Edgar:** There are people like Phil Glass, who is a guy that really knows what he's doing. Those people we like. People who know what they're doing, who want to explain to other people. People like Riley or Reich or Glass, or other European composers. But we are definitely not

anywhere near copies of their thinking. What they're producing in music is in fact what they're thinking about.

**Peter:** Two things to that. I don't see that as a very big problem because this has been ours alone. It will be our rock. I think the first musicians who made the rock music were competing with each other in some sense because, I don't know, they wanted to sell more albums or something. Now, with punk rock groups they are really fighting. One punk rock says, "the others are just doing it because it is in fashion but we are the really punk rock group. Look, I am cutting off my ear. I'm the really punk group." I think in a time, the things that are really best will establish themselves. And I don't care about someone else making some copies of an album because I want to be sure what I am doing. And I think in the end everything is going through which has a very fundamental thought about it and not that much which is superficial. You forget it in a time. It doesn't matter. It really doesn't matter. It's very dangerous if it hits your legs and stops you from going on. You have to be careful and you have to kick a little to have your free way but in the end you become sure about what you're doing.

**Doug:** *Do you feel it's harmful in any way that you're being labeled as "Space Rock" or "technorock". These terms have rather specific connotations.*

**Edgar:** I tell you what. If you walk into a

store to get some cream for your shoes and you find the packages are not marked, you won't know which box it's in. So they have to label you in some way.

**Peter:** It depends very much on the level. Maybe some years from today they get more distinctive but even today, everybody is calling . . . it's silly but everyone is calling Pink Floyd the "electronic group." But if you go into detail on the subject and talk to the people, then you know what it is and you don't need to label it. It's just for appearance in the papers and they just have to have it. It is our society and they will not change in that way.

**Doug:** *What projects are you individually working on?*

**Peter:** To go on. I don't think you have to specify it at all. You'll see what will happen.

**Edgar:** What we don't want to do is spend three straight months on the road. More than that could kill. Honestly. We are not a strip tease group that is putting on their music show every night. We want to do what we want to do. We don't want anyone to take care of us.

**Peter:** That's one reason why artificial groups don't work. There are very many intelligent and very keen managers around and they say, "Here I've got lots of money and here I've got some people. I'm going to make this work together." But it doesn't work because it's not original.

**Edgar:** Let's say Roxy Music in England or Kiss in America. It works and everybody gets out a lot of money but all these individuals are killed by an "idea" manager. I don't know the names of the guys in Kiss, and maybe it's not necessary but if one of these guys would be kicked out, what should he do? Paint his face another way or start another group. Very often the whole music scene is just controlled by the ideas of some really silly hands. What I've said doesn't sound too bad but it would kill everybody who tries to be a musician.

**Peter:** It's a constant fight between the musicians and the business. You have to give up something because you need the business, otherwise, you can stay at home, which maybe is the best way. I don't know yet. Somehow you want to get to the people and you just can't do this without the business.

**Edgar:** I've seen English superstars of five or six years ago, who are selling now, hotdogs on the West End of London and believe me it's no joke. If you think about it, you have to be careful. On the money side, I'm not interested in getting a million dollars now. I want to get ten thousand dollars each month for the next twenty years. That's what I'm interested in if you put it that way.

**Doug:** *What concept or approach unites you as people and as a musical entity?*

**Edgar:** In the end, the best idea is the best. It doesn't matter who finds the best idea. If you're spending hours and hours fighting about a silly point it's not worth it. ~~~~

## Synapse



**Good news from EML**  
**SPECIAL PRICES**  
Get more for your money. For a limited time we've reduced our prices on the board.  
**POLY-BOX**  
Now add 26 additional pitch sources and a unique polyphonic capability to your synthesizer. Adapts to most synthesizers.  
**KITS FOR SYSTEM DESIGNERS**  
Do it your way. Design a system that fulfills your own creative requirements. Complete instructions for special applications available.

Write or call today. **NOW CALL TOLL FREE 1-800-243-7270**

**EML** electronic music laboratories, inc. makers of ElectroComp Synthesizers  
P.O. Box H, Vernon, CT 06066 • (203) 875-0751



# Bernie Krause

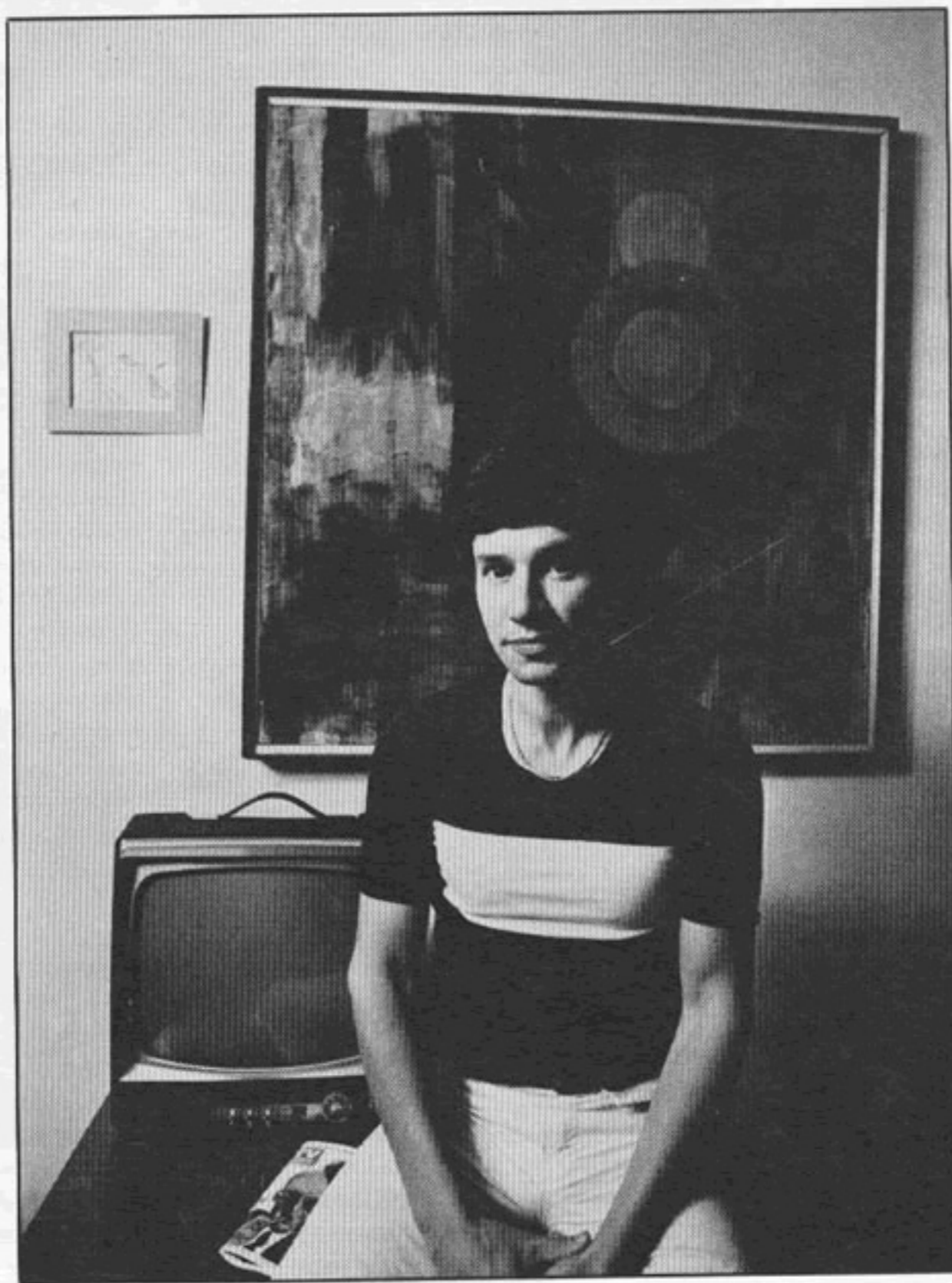

Bernard Krause is perhaps best known to synthesists for his recorded collaborations with Paul Beaver, starting in 1967. Beaver is generally credited with introducing voltage controlled systems to the Los Angeles recording community. After Paul Beaver's death on January 5, 1975, Bernie Krause finished their last project and moved into varied pursuits including studio work on the Tubes' latest record "Now" (A&M SP-4632) and work in Marine Biology.



# Bernie Krause

by Doug Lynner

**Douglas Lynner:** *How was it that you originally got started with synthesizers?*

**Bernie Krause:** Well, I read an article in Time or Newsweek in 1965 about a fellow in New York, Eric Siday, who was earning \$5,000 a second doing sound for commercials. In the meantime, I was playing guitar as a studio musician in San Francisco and I had been in Los Angeles and New York playing as a studio musician before that. I wasn't making a very good living at it and it was a difficult struggle. When I heard that there was a fellow making it that way I figured I've got to find out what this is all about because I love music but I don't want to struggle with it like everybody else. And when I read about the instrument he was playing, a Moog synthesizer, I got very interested in the field. I tried to find a place in San Francisco that had one and although they didn't have a Moog, they had a Buchla. I enrolled in Mills College at the tape music center and began to study with Pauline Oliveros, Tony Gnazzo and Warner Jepson. I began to put together my understanding of electronic music . . . a much more tedious struggle than the one I had just abandoned. It was very academic and most of them didn't know really what was going on, and I began to learn, myself, what it was really all about. Still it was really difficult to get information because nobody could relate it to you in a way that was understandable. I worked at the music center through '66 and ran into Jac Holzman (then President of Elektra Records) who asked me what I was in to. I told him about the synthesizer which could produce theoretically any sound audible to the human experience and he said, "That's really interesting, I'm going to try to do something with synthesizers and I want you to meet some people." So in early '67 he put me together with Mort Garson and Paul Beaver. They flew up to San Francisco to see what a synthesizer looked like because they'd never seen one before and I showed them the Buchla at Mills. Holzman asked Garson to write the music for a record called The Zodiac Album which was done in April of '67. Cyrus Faryar did the narration and one of Mort's friends wrote the script. Some of it was very good and some of it was a little tacky but it was an interesting concept. Jac was one of the great record concept people. He really had it together that way. That was the first pop album in which a synthesizer was featured. I worked with Paul on that in the studio, although I didn't get credit for it. Out of that we became partners. Jac asked us to do an

album based on a conception by Beaver and me. It was an album called, "The Nonesuch Guide to Electronic Music," which defined in lay terms what electronic music was all about. I finally had met a person who really understood it and was able to articulate it in some form. I came down from San Francisco several times a week and had bull sessions with Paul. We just sat down and went over definitions of the instrument and what it was doing. I recorded all of this and finally edited it down into the Nonesuch Guide which has become a standard reference. It was on the charts for 26 weeks. And that's how I got together with Paul, and synthesizers.

**Synapse:** *Were you involved with Paul in Parasound at that time?*

**Krause:** Yes, Paul and I both shared the company. We were equal partners in it. The company was designed to do several things aside from our own albums, record production, commercials and several other things that we eventually got into from a different aspect. Paul went into the design of new electronic equipment and concept work

---

"When I first saw Paul he was on a sound stage with 30 feet of equipment . . . we've come a long way from there."

---

for new electronic gear and equipment. I was more interested in scientific applications of sound; working with environments, and marine biology, and discovering new ways to record sound in marine audio.

**Synapse:** *Could you describe some of what you were doing?*

**Krause:** Well, I've been taking courses in Marine Biology. I plan on completing my doctorate in the field someday. I imagine it will take me several years to get it but it's a field that I really want to go into on a full time basis. There's been work done by John Lilly in the field in communications and there's been work done by a fellow whose name is Thomas Polter, who works at the Bio Sonar Laboratories at the Stanford Research Institute. Those two gentlemen have paved the way for people like Roger Payne, who just put out a second album of whale sounds on Capitol. His first one was the Songs of the Humpback Whale, which is very popular. And now this new one is fabulous. This is what interests me. The equipment these people are using is very primitive and my interest is in developing new equipment, new

concepts for recording, new ways of tracking the mammals by satellite; checking out their biotelemetry and inventing new packages for biotelemetry (breathing, heartbeat, other body functions and sounds that they emit under water). These transmitters that I'm thinking about will be designed to track these pods by satellite. I'm interested in finding new devices that will play back sounds to them; that will synthesize the sounds of the cetaceans (whales, porpoises) whatever they happen to be, and let them feedback off their own vocalizations.

**Synapse:** *After the Nonesuch Guide to Electronic Music, what other albums did you and Paul do?*

**Krause:** We did four other albums together. One on Limelight. Three for Warner Brothers, and one which we had planned called, "Citadels of Mystery" which I completed on my own after Paul's death.

**Synapse:** *What kind of ideas and developments were you working with on those albums?*

**Krause:** Well, the first was a thing called, "Ragnarok" which we did for Limelight. It was mostly a repository for all the garbage that Paul and I had in our minds. We had to get rid of all the crap we had in our heads before we could really move on to something serious and Mercury gave us just enough bread to do it. We had a \$9,000 budget for the album. They're really high rollers at Mercury. When they take a chance, they really take a chance. We put another \$9,000 of our own in it. Everything sucked from the beginning. I'm not happy with that album but it did prove some important things to us. One, that we could record a serious album on 4-track with difficulty, and two, that we could use synthesizer with voice, process different instruments through it and achieve different kinds of effects that later we used on all our subsequent albums. Really adventurous stuff at that time (1968).

**Synapse:** *And then from there?*

**Krause:** In a Wild Sanctuary on Warner Brothers. Warner Brothers was really magnificent. They gave us all the budget and moral support we needed. They gave us feedback that we needed and room to expand and they trusted our judgement because it was a new field.

**Synapse:** *That seems to be the album that was most successful.*

**Krause:** Actually no. The Nonesuch Guide was the most successful of them all and it's the one that we continue to get royalty checks from and Wild Sanctuary is still in the catalog and it's still a decent seller. The one that followed that, Gandharva, which we did in Grace Cathedral with Gerry Mulligan, Bud Shank and several others, is also doing very well. It was an attempt to use synthesizer live with organ, guitar, harp, flute and saxes in a live performance situation and record it quadratically. The first such attempt to my knowledge.

**Synapse:** *What persons or influences do you think are responsible on the whole for increasing the ability for synthesizers to be*



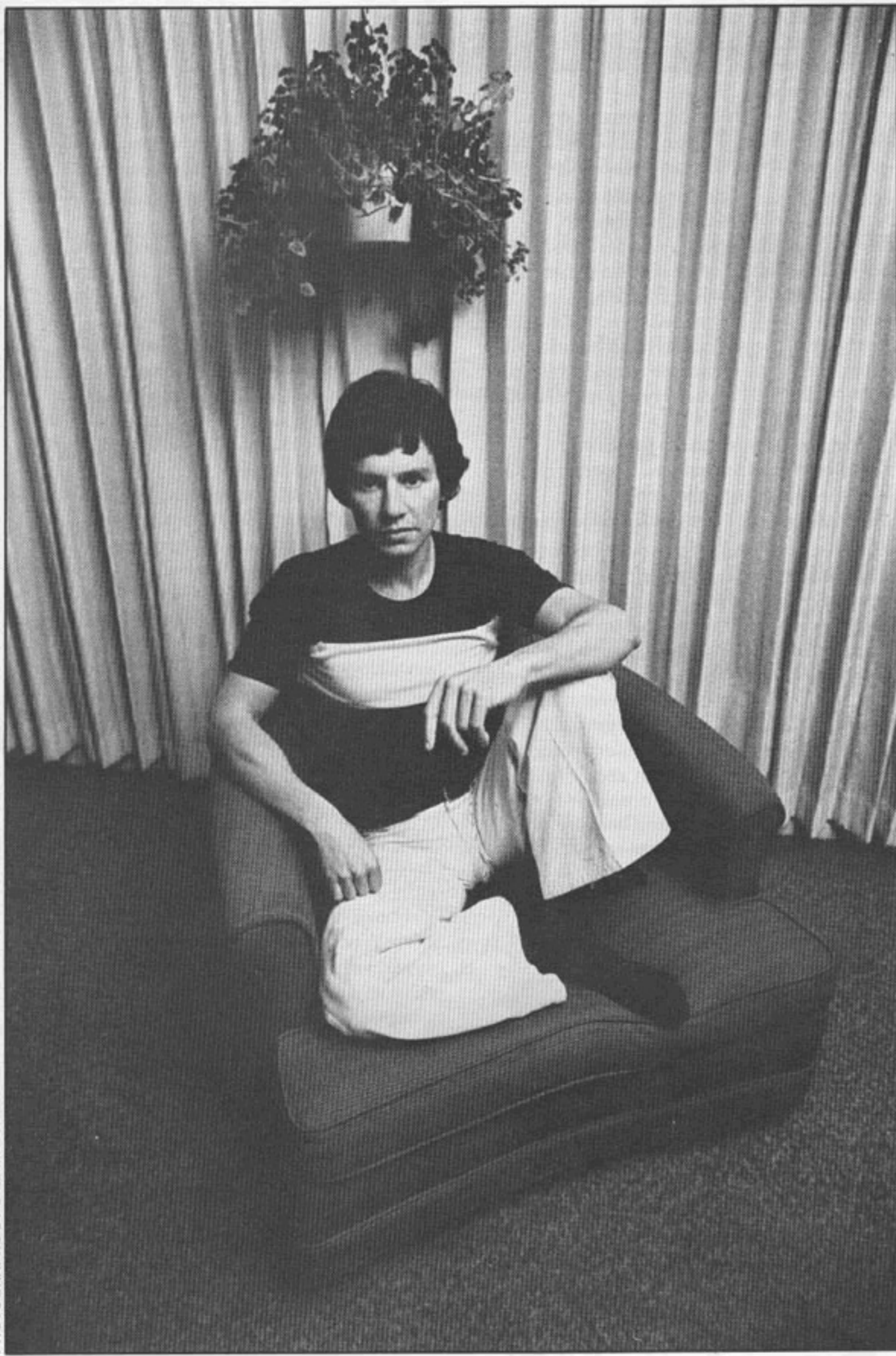

## Bernie Krause

used and enjoyed.

**Krause:** Don Buchla is one. He believed that because the synthesizer was a new instrument . . . actually it's the first new instrument since the saxophone in 1860's . . . it should therefore be approached differently without the use of keyboards in the traditional sense. It should be touch controlled and you should try to develop new techniques for playing it. Moog felt that it should be keyboard oriented because musicians could make the transition easier. I had the idea and Paul had the idea at one point that if the keyboard is good for the keyboard

player, there should be a string controlled synthesizer for the string player and so we tried to develop this. We made several attempts at it. Both went belly up. But there are a few semi-successful ones commercially available.

**Synapse:** What other types of controllers or instrumental interfaces can you envision?

**Krause:** Alpha rhythm, brain waves, skin resistance, stellar information, vibration from the earth, from plants, from any kind of information transmitter. I mean, I can't imagine anything that wouldn't work. There isn't anything that I wouldn't apply it to and

check out.

**Synapse:** What do you feel about the synthesized orchestral music that has found popularity?

**Krause:** Doesn't mean anything to me.

**Synapse:** Why is that? What do you feel about it?

**Krause:** It's very easy to set up a series of sawtooth wave forms, make them sound like strings or horns and play somebody else's music. It doesn't mean anything. It's very nice. It's very well done technically and sounds very good but it doesn't mean anything. I don't get off on it.

**Synapse:** What sort of directions do you prefer?

**Krause:** Um, well, to push sound to the limit. To break through new ground in making a synthesizer sound powerful, and forceful and dynamic without making it sound like something else; without the squeaks and the squaks and the funny high pitched nasal sounds that people often go for with synthesizer because they're easy to get and everybody says, "Yeah, far out." I find myself as a side man doing it for other people and it sometimes gets very boring.

**Synapse:** How have you been utilizing synthesizers since your work with Paul?

**Krause:** I did an album called, "Citadels" and it incorporated jazz, synthesizer and vocal chorus. I tried to use the synthesizer to reinforce the sound of other instruments; to make them sound bigger or to make them sound more spacious. We used a bass flute on one of the tunes that we did on "Citadel" and I coupled the line on synthesizer to magnify it. Not to imitate the flute but to make it expand in space; in aural space. And I used it as a solo line in some instances. I never used it for strings. When I wanted strings, I used strings. When I wanted horns, I used horns. I don't like to synthesize them particularly. I think it's a cheap way to go, and I think it sounds bad. Some think it's very good. I can't comprehend it. I find it sounding very much the same. I try to push the synthesizer beyond its popular limits. Paul and I, did a thing that I feel is very important. We did a cut called, "Spaced" done on In a Wild Sanctuary. We did that big chord gliss. You can't do that on most instruments. Synthesizer is the only one. That's the kind of thing I'm talking about. The kind of thing that Cecil and Margouloff did on Tontos Expanding Head Band where they synthesized the human voice. That's pushing the use of the synthesizer beyond any scope; any realm of possibility that you would ordinarily think of, and that's what I'm talking about. It happens in very few instances, but I get tired of all the rest. I don't have the patience.

**Synapse:** What problems do you think exist with synthesizers that are available at this time?

**Krause:** Well, the dust really hasn't settled for me, as far as people really discovering what the potential of synthesizer sound is; of coupling a number of oscillators with several filters, with several amplifiers, with different control units or sequencers and so on. We



don't really quite understand what the potential of that is and won't until artists get down and refine it for a couple of more decades. I'm sure it will probably take that long unless some four year old genius comes along and solves it next week. I just don't think that the right instruments are going to be made for a while, not until that happens. The technology is available but the people to direct Moog and ARP and Buchla and E-mu, to tell them what to do, what really needs to be done, don't exist right now. Many of the folks playing the synthesizers are well over 30. They came up from the bands in the 60's . . . the music of the 60's and the thinking of the 60's. And there's a certain kind of rut. They're the ones who are giving feedback to the manufacturers. They were already established, for the most part, before they did that. So the difference between those people and Paul, is Paul saw it all. He was timeless. When I first saw Paul he was on a sound stage with 30 feet of equipment on a table. He scurried back and forth between tape recorders, strange keyboard instruments and oscillators, plugging them in and playing them to score, in real time. You know we've come a long way from there. I think it's going to stay pretty much where it is until people settle on certain techniques of synthesis.

**Synapse:** *Until there becomes sort of a standard that people can use as a reference?*

**Krause:** Yeah, you need some kind of standard reference, and you need a standard

reference that is really unique in its intelligence.

**Synapse:** *What other projects have you worked on since Citadels?*

**Krause:** Citadels I did in September and October of '75 and I'm doing some film scores.

**Synapse:** *What films will you be doing?*

**Krause:** A couple of small things in San Francisco. I've been doing radio and television commercials. A lot of those. I've been writing with a woman who wrote two Broadway shows and an Off-Broadway show and some stuff for Sesame Street and Electric Company. I'm producing for different artists. I'm looking more and more to get into record production. That's what I really want to do now.

**Synapse:** *As opposed to perform?*

**Krause:** Yeah, as opposed to perform. I also did a little work with the Tubes.

**Synapse:** *What were you doing with them?*

**Krause:** It started off as a possibility to produce them and I did one number with them, a single, and then it ended up I was just playing synthesizer with them on the new album and did several tunes, which I enjoyed very much incidentally. I think they're a very talented group. They're quite inventive.

**Synapse:** *Did you feel their approach to synthesis is unusual for a popular group?*

**Krause:** It's much more open and much more free because synthesizer is an integral part of the group and because Bill Spooner and Mike Cotton are really

interested in exploring possibilities and the regions of sound. They love to do that and I like working with people who have imagination.

**Synapse:** *Are there any people that you've worked with in the studio that are not necessarily synthesizer players but are interested in hearing things they've not heard before?*

**Krause:** Van Dyke Parks, The Doors, Paul Rothchild who was The Doors' producer. Relatively few. Of the two or three hundred groups or artists that I've worked with, very few stick out as being really on top of what it's all about; mostly because at the time I was working with them they just wanted to score a synthesizer player for the studio; to have it on their album. It was very hip to have synthesizer on your album.

**Synapse:** *You've pretty much said that you feel there are really very few people that can play the synthesizer well. Everyone I talk to feels the same way and I wonder, well, if this is the case, what is responsible for this? Is it just the amount of time spent learning or do people need to open themselves, make themselves vulnerable because they have to learn something? Where do you think the problem lies?*

**Krause:** Partly in the ego of the artists who you're talking to, and partly in professional jealousy; not wanting to recognize other people. I recognize several other musicians as being very talented but their facility is not in physics of sound which is what synthesizer is really all about. Their facility is really more in keyboard. I could hardly say to anybody that Stevie Wonder is not a good synthesizer player. He's a great synthesizer player, but really what he is is a good keyboard man and he happens to select reasonably tolerable sounds for his work. He does good work. He's very technically proficient. Some of the things he did on the last album are sensational, but in terms of again pushing the synthesizer, I can't think of too many people. Cecil and Margouloff are the only ones that really come to mind that have been doing that kind of work.

**Synapse:** *Do you feel that there is an any way in which the term "electronic music" falls short in describing the sounds? For instance, does the term mean to you that a sound is produced electronically or does it describe the timbres or approach? How do you use the term?*

**Krause:** What ever anybody wants to recognize as electronic music is okay with me. I mean, I have no quarrel, no axe to grind there.

**Synapse:** *No, I mean for yourself.*

**Krause:** Hammond organs are as electronic and amplified guitars are as electronic to me as a synthesizer. Any amplification of any vibrating source is electronic music to me. It doesn't make any difference what it is.

**Synapse:** *So it is a matter of technology then?*

**Krause:** Yeah. Simple as that. Amplify a vibrating source and you have electronic music. 

## Synapse

# EMMSA

MOOG

OBERHEIM

ARP

EMS

NEW

USED

269 LOCUST STREET, NORTHAMPTON, MA 01060

TELEPHONE (413) 586-3777



# What makes these stores unique?

## AUSTRALIA

Brookvale  
Farrell Keyboards  
Claremont  
Zenith Music  
Fitzroy  
Warehouse Sound Co.

## CANADA

Montreal  
Richard's Music Shop  
Vancouver  
Paradox EMS  
Winnipeg  
Guitarland

## JAPAN

Tokyo  
distributed by  
Music Joy/Rittor  
Publishing  
and  
ASCII Publishing

## CALIFORNIA

Azusa  
Music Plus  
Berkeley  
Rather Ripped Records  
Glendale  
Music Plus  
Hermosa Beach  
Music Plus  
Hollywood  
Music Plus  
La Mesa  
La Mesa Music Machine  
Long Beach  
Music Plus  
Los Angeles  
Guitar Center  
Hollywood Music Store  
Musician's Contact Service

Monterey Park  
Music Plus  
North Hollywood  
Music Plus  
Northridge  
Springfield Music  
Oakland  
Leo's Music  
Orange  
Music Plus  
Pacific Beach  
Licorice Pizza  
Pasadena  
Music Plus  
Placentia  
Music Plus  
San Diego  
Guitar Center  
San Francisco  
Guitar Center  
Santa Ana  
Music Plus  
Santa Barbara  
Castle Music  
Fancy Music  
Jensen Music  
Morninglory Music  
Turning Point Records  
Valley Music  
Santa Cruz  
BookShop Santa Cruz  
Sherman Oaks  
Baxter-Northrup Music  
Music Plus  
Studio City  
Music Plus  
Thousand Oaks  
Music Plus  
Westminster  
Music Plus  
West Covina  
Hanich Music

West Los Angeles  
Eighth Note Music  
Rhino Records  
Westwood  
Rhino Records  
Whittier  
Music Plus  
**COLORADO**  
Denver  
Schaeffer Enterprises

## CONNECTICUT

Danbury  
Danbury Electronic  
Music

## ILLINOIS

Highland Park  
Gary Gand Music  
Marissa  
Ye Olde Music Shop

## KENTUCKY

Bowling Green  
Fairview Plaza Music  
Center

## LOUISIANA

New Orleans  
Allied Music

## MARYLAND

Randallstown  
Randallstown Music

## MASSACHUSETTS

Boston  
Pampalone Music

## MICHIGAN

Canton  
Arnoldt Williams Music  
Saginaw  
Bay Music

## MISSISSIPPI

Crenshaw  
The Music Man

## NEW JERSEY

Paramus  
Sam Ash

## NEW YORK

Brooklyn  
Sam Ash  
Hempstead  
Sam Ash  
Huntington  
Sam Ash  
Kenmore  
Clean Music Systems  
Manhattan  
Sam Ash  
White Plains  
Sam Ash  
Jack Bronen's Music

## OHIO

Cleveland  
Mayfield Music Co.  
Pi Corporation  
Streetsboro  
Streetsboro Music

## TENNESSEE

Memphis  
Strings and Things  
Nashville  
Music Man

## WASHINGTON

Seattle  
The Electronic Music Box

## WISCONSIN

Milwaukee  
Disco-Tech Music  
Electronics

They all have a special interest in electronic music. They support the new musical awareness of their clientele. How do we know? Because they all carry Synapse. And it's not just for love or money, but for the information and service their establishment can provide. Readers, do your music and record shops stock Synapse? If not, show them Synapse and get them in touch with us. Retailers, what are you waiting for? Write or call: Synapse Retail Sales, (213) 383-7933, 2829 Hyans Street, Los Angeles, California 90026.

**Synapse**



# TECHNIQUES OF ELECTROPHONY

by Eric Valinsky

In the past few years, considerable energy has been spent on the design and implementation of polyphonic synthesizer keyboards. It may be that much of this energy has been misspent, due to the limitations that polyphonic thinking places on the range of electronic music possibilities. Yet, polyphony is the traditional Western method of creating a rich sonic texture. This article will present a few alternate techniques which produce a rich musical texture without polyphonic keyboards or, subsequently, polyphonic thinking.

In designing analog systems, Robert Moog based his main control source on the traditional electronic organ keyboard. At the same time, Buchla developed a manual controller consisting of individually tunable, pressure-sensitive plates, thus avoiding the built-in tonal prejudices of the black-and-white keyboard. But the Buchla keyboard was awkward for playing Bach, and after Walter Carlos's commercial success, it was evident that the organ keyboard would become the electronic music standard. Indeed, by the time second and third generation synthesizers made their appearance, the synthesizer had become just another keyboard instrument.

Remember that at this time the most popular electronic music was arrangements of the music of J. S. Bach, whose polyphony had rendered the one-note keyboard obsolete. Hence the need for a truly polyphonic keyboard, leading, in the past few years, to limited polyphonic systems, by Oberheim, for example, and microprocessor controlled systems such as the E-mu polyphonic keyboard and the Strider Systems DCS1. The presents state of the art is the Polymoog, boasting a separate tone (not oscillator) for each key, thus conceptually returning to the electronic organ.

Is the Polymoog fully polyphonic as it is claimed to be? A broad, classical definition of polyphony is:

*Music written as a combination of several simultaneous voices [parts] of more or less pronounced individuality.<sup>1</sup>*

In electronic music terms, a truly polyphonic synthesizer must allow the performer to (1)

produce many different sounding voices simultaneously and (2) control completely the assignment of a particular key to a particular voice at any instant of time.

Both the Polymoog and the Oberheim Polyphonic meet requirement (1), though in different and limited ways. Both systems fail requirement (2), which is the hard part. The limited key assignment capability of each system forces the performer to use the instrument to produce a homogeneous chordal structure termed *homophony*. Thus the Polymoog and the Oberheim are essentially *homophonic* synthesizers.

So far, quite a bit of space has been devoted in this article to the concept of polyphony and it has not been space well allocated. The traditional concept of voicing itself is to blame, in that it limits the electronic composer to thinking about notes, rather than the more general event concept outlined in the author's last article. Much of the potential of synthesizer technology is being wasted. And in spite of their limited application, multivoiced systems are expensive, since each voice requires a duplicate set of components.

So enough talk of polyphony and homo-

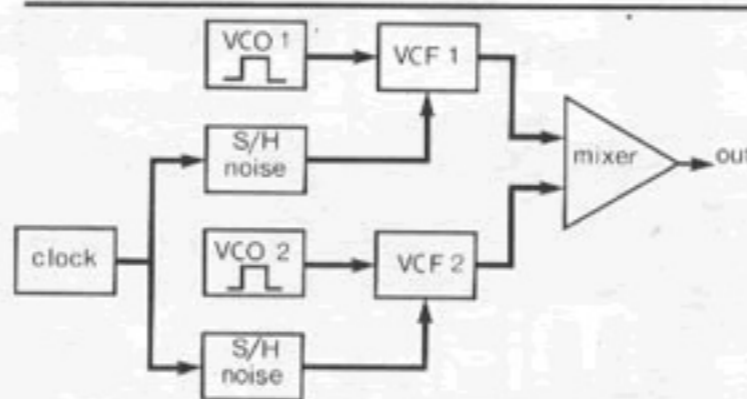

Figure 1: An electrophonic patch.

phony. The author would like to propose a new phony, *electrophony*, to describe techniques of producing a rich electronic music texture without resorting to traditional polyphonic means. The following primitive but effective example will illustrate the concept of electrophony.

The patch configuration appears in Figure 1. The two VCO's are tuned to bass frequencies, one octave apart. Each sample-and-hold samples its own noise source, and the Q of the filters is adjusted almost to the point of oscillation, thus producing two sets of randomly occurring overtones. Polyphon-

ically speaking, the patch is two voiced, each VCO-VCF combination comprising one voice. Listeners have reported hearing at different times three voices, namely the two sets of overtones plus one fundamental; four voices: two overtone sets and two fundamentals; two voices as above; or two voices with the fundamentals as one and both overtone sets as the other. Sometimes the entire patch is heard as one voice. This

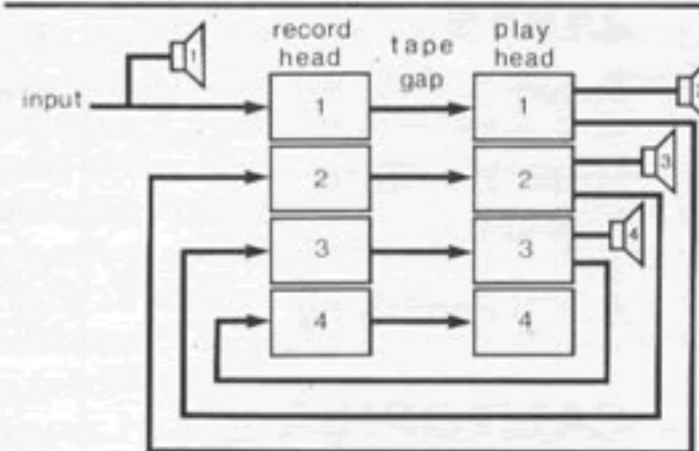

Figure 2: Quad rotating tape echo.

ambiguity of perceived voicing is characteristic of electrophonic techniques.

A few additional examples of electrophony will conclude the article. The first technique is adapted from the music of J.S. Bach, the unwitting perpetrator of synthesizer polyphony. By carefully selecting pitches, Bach was able to make a single voice sound like two to three voices. This technique of *polyphonic simulation* can best be electronically implemented by rapidly cycling a sequencer controlling a sound source. Pitches can be selected which cause many voices to be perceived. A sequencer of many more than eight stages is preferentially used.

A less predicatable, sequencerless method utilizes many sub-audio square waves controlling a sound source, thus producing discrete pitches. If the square waves are tuned to slightly different frequencies long patterns of changing rhythms result.

The technique of *homophonic simulation* is borrowed from Ronald Pellegrino. A fixed sine wave tuned to, say, C an octave above middle C, is fed into one input of a balanced modulator. A waveform, pitchcontrolled by a keyboard (Pellegrino used a live soprano), is fed into the other input. The balanced modulator output and the two inputs are monitored simultaneously. Correct pitch se-

ILLUSTRATIONS BY SUE DENIM



lection of the variable waveform produces a limited number of four-note chords.

These first few examples have used pitch techniques. The next example does not. The technique was used by the author in *A Clarinet, After an Eventful Night Out, Returns Home*, for clarinet and ARP 2600 synthesizer. A four channel tape recorder is configured as shown in Figure 2. Each channel is in the record mode, and the play head is monitored. There is no feedback, so the original signal occurs four times and disappears. The resulting sounds can be mixed together or used directly as a rotating quad signal. In recording, the fourth channel is used as shown, however, in live performance the four channels must be monitored as shown by the speaker symbols, or the original sound will be confusingly delayed.

Lastly, an electrophonic technique for polyphonic synthesizers, such as the Oberheim. Each voice on the synthesizer is set differently from the others. When many keys are played, the keys are assigned to voices in a more or less unpredictable manner, with interesting results.

Electrophony is a term which can broadly apply to most styles of electronic music, including musique concrete and classical studio techniques. Electro-phonic music can be pitched or unpitched, predictable or unpredictable, stochastic or deterministic, taped or realtime. In any case the multivoice syndrome must be avoided by efficient use of the available technology. The technology is there; the technology is sophisticated. It is up to the composer to use it in a sophisticated way. ~~~~

Ref: 'Apel, Willi, *Harvard Dictionary of Music*, Harvard University Press, Cambridge Ma, 1968, p. 593

sound advice  
programming

entropy west  
electronics

· REALTIME ELECTRONIC MUSIC  
1242 HARVARD ST., SANTA MONICA  
CALIFORNIA 90404 · (213) 828-0389

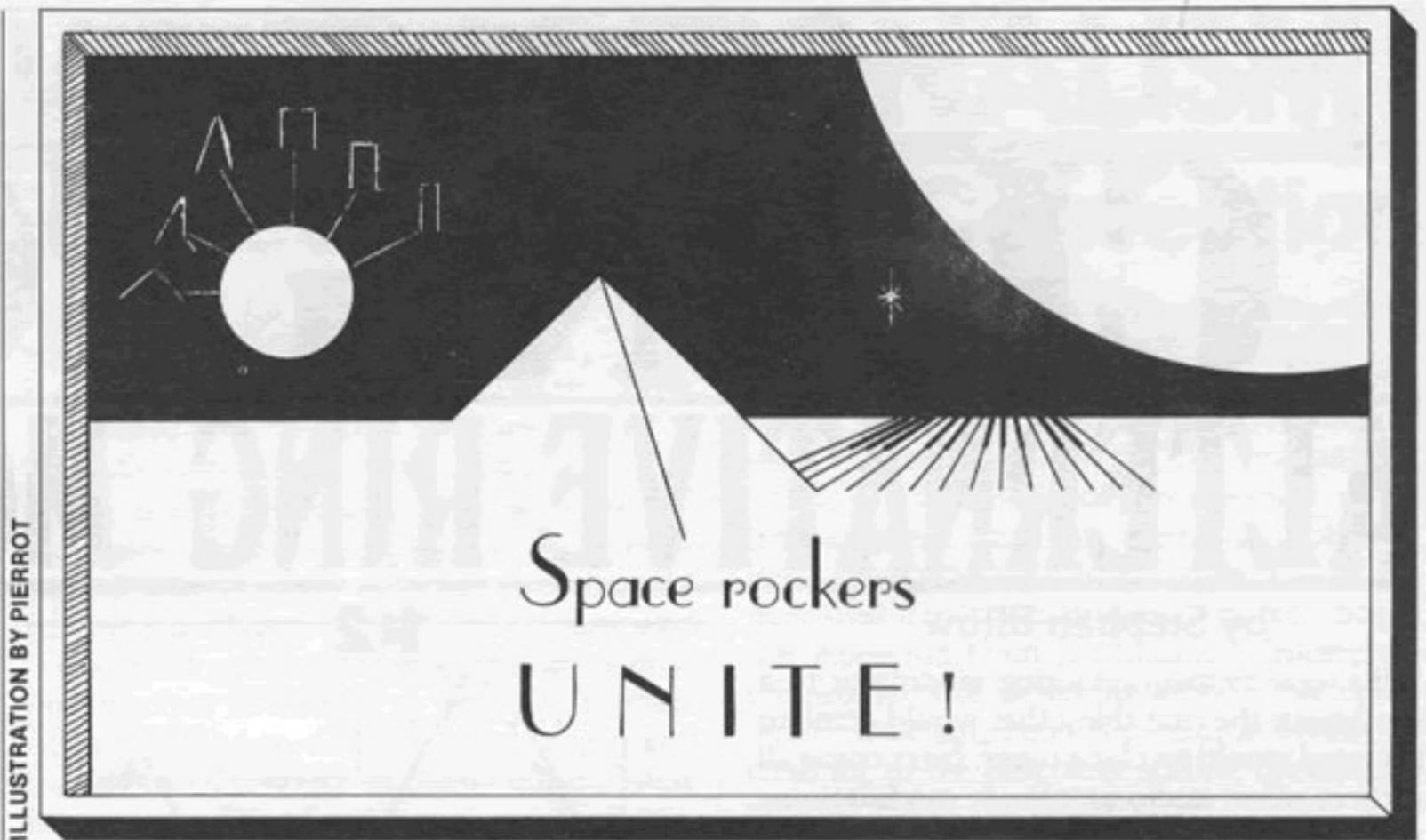

### by Magic Moe

*In the following short article Magic Moe outlines some ideas for cooperative promotion. If response warrants, MM has promised to further describe "alternative" marketing techniques for your music.*

The synthesizer revolution of the 1970s is in full swing and with it comes a new generation of artists, the electronic musicians. Today more than ever before a composer can express his ideas to the max. With the aid of polyphonic synthesizers, signal processors and the all important "affordable home studio," one lone musician can create a veritable orchestration. There seems to be a wealth of fresh musical concepts on the horizon waiting to unveil a rainbow of sound and vision. Unfortunately the record industry in this country just isn't willing to gamble on an unproven product. So the major problem facing electronic musicians is marketing their product. For the techniholics (those who study the path of electrons purely for pleasure) or the independently rich, c'est pas grave but for those of us who have put our lives on the line for music, art for arts' sake doesn't pay the rent. I get up, I get down. . . . and with intense optimism (could be a caffeine rush) I believe there is a market for electronic music, larger than the record industry will admit and just waiting to be cultivated! If this sounds a bit idealistic, consider the success of techni-rock groups (which I dub Space Rock, because of the influence and inspiration of science fiction) such as Pink Floyd, Yes and now a new wave of space rock including Camel, Vangelis, Tangerine Dream, etc.

In 1974 my group French Lick moved to Europe because of the frustration of not fitting in the L.A. music scene. Our reasoning was that since most of the groups who inspired us (Gong, Crimson etc.) were European, we must have been in the wrong country. French Lick struggled for 2 years overseas and paradise it wasn't, but I brought back a few brilliant (at least for my digitally delayed brain) observations.

1) There is a space rock audience in the

U.S.A who purchase: A—Electronic B—Progressive C—Avant Garde D—Any or all of the above music.

- 2) They are for the most part a very intelligent and trippy or cosmic species.
- 3) They can be found anywhere from Eureka, Calif. to New York City.
- 4) The record companies call them a cult following but they have been known to multiply into a bona fide legion of fans.
- 5) They thrive on the import section of your local record store.

Some of the reasons why they buy imports, echo the philosophy of the Space Rocker: less commercial, more original, more creative, different, refreshing and so on. Europe offers specialized labels such as Virgin and Brain, for which musical freedom is the policy. Now, I've been doing some media experiments and I'm convinced that the space cadets can be lured from their lairs. The best way to accomplish this would be in force so: SPACE ROCKERS UNITE!!! What we need is our own conceptual record labels, a few clubs in the major cities that will book us (imagine Fripp&Eno and Terry Riley at the local night club) and communication between each other to promote concerts, exchange ideas, gear, or knowledge. Stronger bands may re-form between us! Consider the flow and togetherness European Space Rockers have. I played among them and can vouch for the fellowship they share. America is supporting them. So stand up and be counted, together we can't be ignored. Dali, Ernst and Magritte were once part of the powerful surrealist movement in the 30's. Following their example, we could bring new life to the stale business of music. A magazine like SYNAPSE is the breath of our cause so if you haven't subscribed, think about it!

I'm willing to take the first positive step of communication so send me your ideas, feedback, reactions or contributions c/o SYNAPSE, and stay tuned for progress reports. With all of our combined cosmic energy we might get something off the ground which Kurt Vonnegut would surely call: "The Big Space Fuck" ~~~~



# BEYOND THE CLANG TONE

## ALTERNATIVE RING MODULATION

by Stephan Bilow

If I were to mention a ring modulator to a synthesist, the first thing that would come to his mind would be clang tones. Next come all sorts of other audio-amplitude modulations. And, to the inexperienced synthesist clang tones might be the only thing related to the ring modulator. But, there are many other uses of the ring modulator.

To start with, let's look at how the carrier input of a ring modulator modulates the signal. Diagram 1:1 shows the basic set up for a ring modulator with two VCO's as inputs. Before discussing diagram 1:2 let's think about tremolo. With an LFO or sub-audio

**1:1**

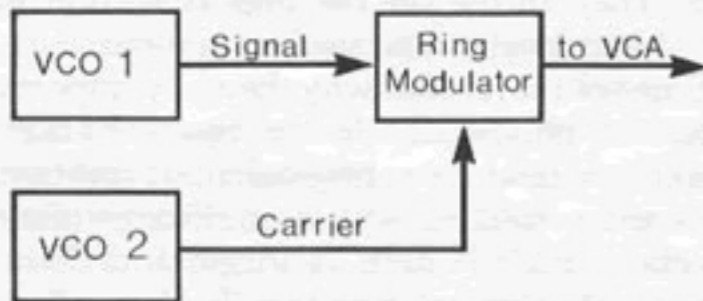

VCO controlling an amplifier, the lower the wave gets in voltage the lower the amplitude and the higher it gets the higher the amplitude. In diagram 1:2 the dotted line A represents the place where the amplitude of the signal is highest and dotted line B is the point where the amplitude is lowest. To understand this we must first understand the rate of voltage change in the waveform shown. In a sine wave the slowest rate of voltage change is around the top and bottom curves and the fastest rate of change is in the straightest areas. The signal input is made louder when the carrier has an abrupt, great change and is made quieter when the change is gradual. Therefore, by placing a sub-audio sine wave

**1:2**

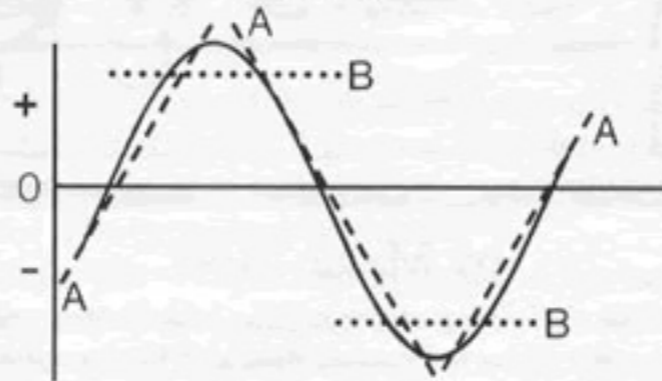

on the carrier of the ring modulator we achieve a tremolo effect but we also have developed a background in ring modulation which enables us to explore many more possibilities. Diagram 1:3 shows a ramp wave. Looking at this diagram we can see a constant rate of change through the slope of the waveform and a great position-negative

**1:3**

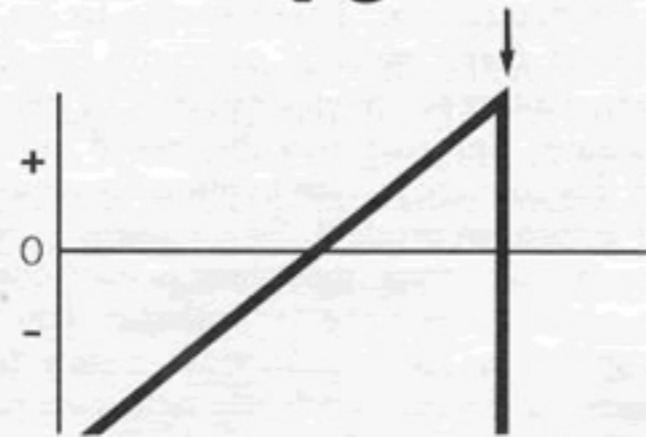

change in the straight portion indicated by the arrow. What does this show us? We will have a constant amplitude through the slope and a great sudden increase (a loud "blip") at the vertical portion of the wave. The square or pulse wave shown in diagram 1:4 is characterized by an unchanging positive voltage, then a sudden change to an unchanging negative voltage. Three arrows indicate the three

**3**

points of change, at these points we will receive a "blip" from the voltage change but there will be no other sound produced due to the fact that there is no voltage change besides instantaneous jumps from positive to negative.

By altering frequency, amplitude and in the

**1:4**



case of the pulse wave, the pulse width, of the signal and the sub-audio carrier, a great number of interesting effects can be achieved. To even further expand on this idea try combining two carriers or even three at the same time.

In this program, realized on the Steiner-

**2**

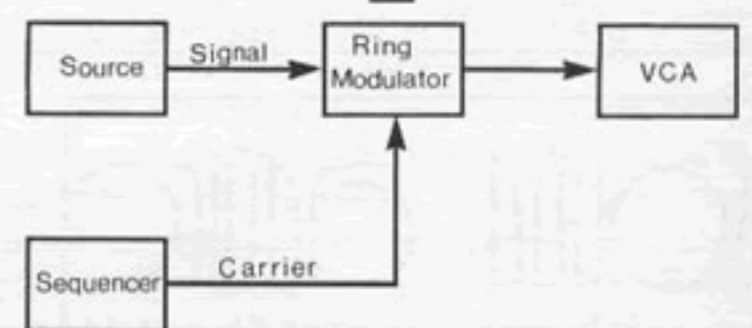

Parker Synthesystem, the output of the sequencer voltage is used as the carrier for the ring modulator. The procedure is as follows:

The ring modulator will allow no signal to pass if the carrier is a constant D.C. voltage. Should the voltage on the carrier (even D.C.) be changed, a signal will be allowed to pass

	1	2	3	4	1	2	3	4	1	EFFECT OF VOLTAGE CHANGE
1	⊙	⊙	⊙	⊙	---	---	---	---	---	(EQUAL VOLTAGES) NO VOLTAGE CHANGE, NO RHYTHMS
2	⊖	⊙	⊙	⊙	▭	---	---	---	▭	HIGHER VOLTAGE AT STEP 1, 2 ACCENTS BETWEEN STEPS 1 & 2, 4 & 1
3	⊙	⊙	⊙	⊙	▭	▭	▭	▭	▭	SEPARATE SETTINGS ON ALL FOUR STEPS, FOUR ACCENTS OF DIFFERENT AMPLITUDES. LARGEST CHANGE, LOUDEST ACCENT.



# CONCEPTUAL TRADITIONALISM: The 57th Audio Engineering Society Convention

by Eric Valinsky

The 57th Audio Engineering Society convention occurred at the Los Angeles Hilton from May 10-13. It lasted four days, but it can be summarized in a single sentence: Technological sophistication was limited by conceptual traditionalism. For the sake of conciseness, the review should end here, but the reader deserves a clarification of the above statement.

The exhibits featured the usual overwhelming array of mammoth and expensive sound systems, elaborate and expensive test equipment, and complicated and expensive mixing consoles. Digital and computer technology made their mark.

Two digital tape recorders, by Mitsubishi and Soundstream, were demonstrated. Each recorded audio signals on tape as digital information. Each allowed recordings to be reproduced independent of tape and transport quality (i.e. with zero distortion, wow, flutter, or dropout), but neither was much more than a tremendously expensive tape recorder.

A minicomputer controlled sound manipulation system, System 5 by Computer Music, Inc. turned out to be a large collection of computer simulated effects generators for an even larger price. More examples of the use of sophisticated technology for mundane purposes follow.

A number of automated mixing boards were presented, including computer driven systems by Rupert Neve (NECAM), MCI, Quad/Eight (Compumix III), and Allison Labs. The use of computers to extend the range of mixing systems is potentially exciting. The rub is that systems are designed which work identically to conventional mix-

ing consoles, for the benefit of the audio engineer with no programming ability. Mixing, then, is done traditionally and the levels are stored in computer memory. Thus, a \$185,000 system replaces a .25c pad of paper.

The technical sessions were no more enlightening, devoted primarily to the promotion of new products which do the same old things better. However, James A. Moorer and Loren Rush presented truly innovative mixing concepts developed at Stanford University's Artificial Intelligence Labs, long noted for advanced research in digital music. Their Interactive Editing System performs the audio feats of redefining the envelopes, pitch, and timing of recorded signals, and can separate two sounds recorded on the same track.

But it is about time to cover those aspects of the convention directly of interest to electronic musicians. Sound Arts Studios and the Los Angeles Center for Electronic Music both exhibited a large variety of electronic gear. The hopeful at the LACEM booth was the Strider Systems DCS1, a digitally controlled analog synthesizer. The system required no programming ability, but was limited in flexibility and concept. A recurring theme.

Sound Art's demo room featured 360 Systems Slave Driver, a programmer for performance synthesizers by Sequential Circuits and a complete array of Moog Modular products.

Tuesday's technical session on electronic music, chaired, or emceed rather, by Morton Subotnick, included four papers and a panel discussion. Peter Hillen of National Semiconductor presented a computer controlled synthesis system, as did Dave Rossum and Scott Wedge of E-mu systems. Both systems were excellent designs, but both suffered limited flexibility. A demonstration of the Eu system,

a computer controlled keyboard, was effective in a commercial organ way.

John Dunn reported on the electronic music, video synthesis, and digital control scene at the School of the Art Institute of Chicago. He described performances there involving the realtime interaction of live performers with the digital system. Lastly, an insightful paper was presented by composer Jon Appleton from Dartmouth, concerning the problems of designing an effective computer music language. A polemical breath of fresh air to the otherwise stifling conceptual atmosphere of the convention.

The panel discussion centered on the problems that electronic music composers face in relating to their equipment. Little was said about the use of synthesizers in commercial music, which was refreshing. Unfortunately little was said about anything else either, a situation typical of panel discussions. The panel included: Serge Tcherepnin of Serge Modular Systems, Donald Buchla, Peter Zinovieff of EMS, Barry Schrader and Darell Johansen from Cal Arts, Peter Hillen, Dave Rossum, Scott Wedge, Jon Appleton, and John Dunn. In all, some fine old ideas were reconfirmed.

What was learned at the convention? That there are a lot of new products and they all cost quite a bit. That products which are radically different in function are not likely to appear. That, most importantly, systems designed for engineers with traditional mixing concepts, for composers with traditional music concepts, and for anyone with no programming ability, are limited in flexibility and conceptually uninteresting. The moral is that, in order to permit conceptually sophisticated designs, composers and audio engineers alike will have to learn some computer programming. ~~~

and its amplitude will be proportional to the voltage change.

In the abstract program in diagram 2 you can see how the sequencer is connected to the ring modulator. In addition to the sequencer a sub-audio VCO, transient generator, or the keyboard can be connected to the carrier of the R.M. This basic diagram can be greatly expanded on for many fantastic effects.

In diagram 3, column one shows the dial settings for four sequence steps. Column two shows a drawing of the effect of voltage changes shown in column one, and column three briefly describes the effect shown in column two. In line one of diagram 3 we see four steps of the sequencer set to have the same voltage output. With equal voltage outputs there is no change thus the ring modulator cannot allow the signal to pass, consequently we have no accent. Line two shows us the effect of a single step voltage change. Here we see that as the sequencer

enters step one we get an accent. We also get an accent as the sequencer leaves step one. Finally, in line three we see the effect of the ring modulator on the signal when all of the sequencer steps are set differently. The difference between the voltage in step one and step two determines the amplitude of step two. The difference between the voltage of step

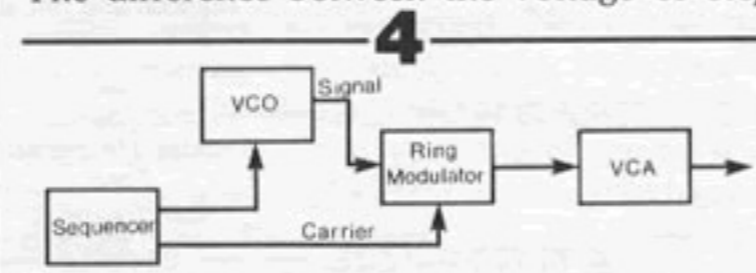

two and step three determines the amplitude of step three. This is the same between steps three and four and steps four and one. The ring modulator cannot differentiate between positive or negative change; it can only detect that there is a voltage change.

A rather interesting program which I

developed based on the above principles is one in which the difference in pitch between one note in a sequencer and the next is related to the dynamic difference between the two notes. This is done by taking the output of the sequencer and having it control both the signal producing VCO and act as the carrier of the ring modulator. This is accomplished by the method shown in diagram four. Basically, when one note is played, the note following it will be loud or soft depending on the pitch proximity of the two notes.

There are quite a few other ideas such as: Substituting a keyboard for the sequencer. Using both an audio and sub-audio carrier for the ring modulator. Using frequency divided sub-audio carriers. And, using the output of the ring modulator for control purposes. I will not attempt to go into these aspects at this time but you can experiment and find literally thousands of variations and new ideas—try it. ~~~



# INTERFACING ACOUSTIC, ELECTRIC AND ELECTRONIC KEYBOARDS WITH SYNTHESIZERS

by Alex Cima

There are endless possible combinations when interfacing synthesizers and accessible acoustic and electric keyboards. "Concrete" tape techniques aside, this article will be considering elements in live performance.

Perhaps the initial idea in using acoustic or electric pianos is that they are polyphonic and truly so, thus an ideal sound source for processing and control. Also, several of the myriad electronic treatments may be applied in any style, be they classical, rock, jazz, or fusion groups. The main limitation is that in most cases it is only possible to alter timbre as the most common of treatments available. Since the control of voltage controlled oscillators (VCO's) is dependent on a voltage, some conversion must first take place from the acoustic or electric keyboard to the control voltage input to the VCO, changing the pitch being played (and its modulations) into proportional voltages which the VCO can then track is a first requirement if the VCO is to track in unison or some parallel harmony and follow the pitch of the instrument being played. This conversion can only take place on a one note basis unless rather sophisticated digital hardware and software is available.

Thus, most synthesizers can alter timbre by filtering, ring modulation, reverb, and so on, and in some systems it is possible to frequency divide and obtain octaves by ring modulation. In these respects it is evident how presets and large modular systems differ, some presets cannot be interfaced because they do not accept external inputs, whereas modular systems by their very nature consist of rather superb tone modifiers.

Pitch to voltage converters may also have triggers and envelopes (inverted or not) as outputs in addition to the pitch following voltage, allowing them to trigger envelope generators, sample and hold patches, control sequencers and other voltage controlled modules. Other threshold detectors such as Schmitt triggers, and Kepex may be employed to afford control from a non-voltage keyboard, otherwise a keyboard performer would have to coordinate the articulation of synthesizers and external keyboards in order

to achieve synchronized envelope generation or desired effects.

One alternative which must be discussed is the use of effect boxes vs. synthesizer modules. Effect boxes accomplish treatments such as filtering, echo, and ring modulation, they are available with their own power supply and are generally less expensive than synthesizer modules, so, why pay more? The advantage to modular systems is primarily that modules can be voltage controlled (vs. manual or pedal) not only at a low frequency rate but at an audio rate as well . . . voltage controlled modules are likely to have better electronics. Multiple treatments are created by processing through several modules, a degree of complexity not usually available from boxes.

The keyboards in figure one were the ones selected because they are universally accessible, represent an example of pianos which utilize different means for sound generation, and because of the author's familiarity with all three.

The strings in the acoustic piano are accessible in grands for "prepared" techniques

(see Richard Bunker's *The Well Prepared Piano*, Colorado College Music Press) such as using combs and ping pong balls (as used in Paul Huebner's "Ocotillo", a piece for piano, ring modulator, and tape). The Rhodes' tuning bars are also available for manipulation; the oscillators in the RMI are not voltage controlled but there is one for every note and they can be independently tuned.

The acoustic's timbre is fairly static and rich in overtones. The Rhodes lacks highs and is generally dull in the midrange and muddy in the bass, requiring substantial EQ before recording. The 73 note model has a tremolo effect built in. Interesting resonances are created in the Rhodes at low striking forces particularly in the bass range. The RMI has organ stops which are essentially a sine-like timbre (lute) and various degrees of bright sawtooth (piano and harpsichord stops), Terry Riley and Mother Mallard's have made extensive use of these timbres in their electronic works.

Dynamic control in the acoustic is entirely in the performer's hands (!), allowing easy control from pianissimo to fortissimo pas-

	ACOUSTIC	FENDER RHODES	RMI 368X
1. SOUND SOURCE:	strings	tuning bars	oscillators
2. TIMBRE:	relatively static rich in harmonics	variable bass, muddy benefits from eq	variable bass and brightness
3. DYNAMICS:	excellent dynamic and expressive control	amplified dynamics	integral volume pedal amplified dynamics
4. ENVELOPE:	static fast attack definite duration manual and pedal decay control	as acoustic	fast or variable (pedal control) attack organ mode increases sustain (also pedal controlled) and decay
5. RECORDING TECHNIQUE:	mic (stereo) Pickup: Helpenstill Frap Barcus-Berry	direct or mic amp	direct or mic amp
6. KEYBOARD SIZE:	88 notes	88 or 73 notes	68 notes
7. KEYBOARD ACTION:	excellent action in good pianos	light action generally uneven thru different ranges	good action organ mode (long keyboard sustain as found in electronic organs) Piano Mode (envelope as in acoustic)

Figure 1: Relevant Characteristics



sages. Amplified dynamics are generally restricted to a small range unless a volume pedal or sensitive mixing ensue.

For the most part, without a volume pedal (which would only provide pedal, not voltage control) it would be difficult to reverse attacks or otherwise modify the envelope of the acoustic and electric pianos . . . however, Eventide Clockworks Inc. manufactures a compressor with dynamic reversal features, such that the fast attack of a piano can be reversed in real time by using the Eventide Omnipressor (for that matter it may be applied to any instrument). This effect accomplishes in real time what would otherwise require recording and reversal of the tape motion. The acoustic and the Rhodes have similar envelopes where the sustain and decay portions have a definite duration and are controlled by hand articulation and pedals. The RMI has a sustain pedal and an organ mode which extends both the sustain and the decay of the sound.

Recording an acoustic piano may be a subject for a PhD thesis; most often it is done by placing two good mics over the bass and treble strings respectively; several pickups are manufactured which overcome the need for acoustic recording. The Rhodes and the RMI may be recorded directly, that is by taking their output directly into the tape recorder's

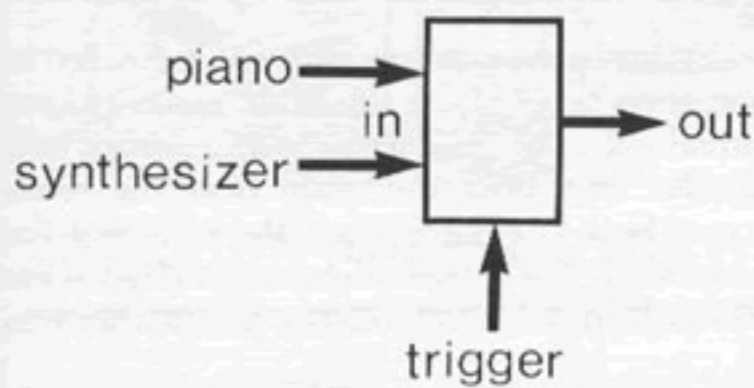

Figure 2a

input section or into the mixer. Some musicians prefer to record from an amplifier with a mic but most of the time these amps are of such low quality that many benefits will be derived by going direct . . . for one it would not be necessary to isolate the sound of each instrument in the recording room.

#### Treatments:

1) **Filtering.** Timbre modification is usually realized through low, band, or high pass filters, the effect is similar to wah-wah pedals, but other uses may be found, for example, increasing the resonance of the filter may tend to reduce the bass content of the sound, modulating the filter with a low frequency oscillator (LFO) will accomplish automatic sweeps, controlling the filter with a sample and hold patch will create interesting (funk) rhythmic patterns, whether keyboard triggered or stepped from a trigger generator. An envelope shaped like a negative slope (descending) sawtooth wave and triggered by a trigger generator will result in echo imitation, the repetition rate made variable by changing the trigger rate. The sequencer applied to the filter will impart to sustained chords a repeating rhythmic effect. Octave filter banks (EMS) and formant filters (Polyfusion, Moog)

increase the subtle timbre modification possibilities. Manually changing the individual filter settings in an equalizer while playing any of the keyboards, particularly a thick tone cluster, will yield very interesting sweeping effects.

2) **Phasing.** Most phasing patches involve slowly sweeping effects, but voltage controlled phase shifters are capable of being modulated at an audio rate also, creating

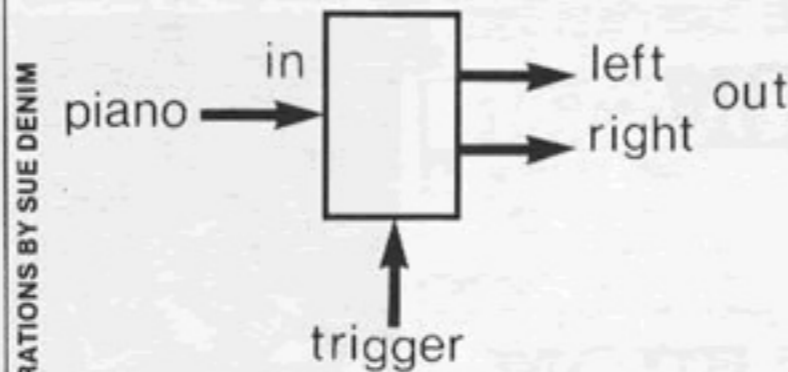

Figure 2b

numerous modulation sidebands, try that with a piano tone. The Mutron Bi-Phase (an effects box with two phase shifters) is an exceptionally adaptable box since it may be modified to accept external control voltages, and since its two outputs may be controlled by positive and inverted voltages, interesting location effects are possible by panning right and left respectively.

3) **Amplitude modulation.** Ideally, VCA control in a synthesizer should be capable of realization from an acoustic piano, on a one note basis it may be done by applying pitch to voltage designs, but most keyboard players coordinate their left and right hand in different keyboards, so that now the term multi-keyboardist is a common adjective. VCA's may also be controlled by other trigger sources, imparting random or periodic automatic patterns to acoustic and electric timbres. The possibility of manual gain is often overlooked. VCA modulation at an audio rate will generate characteristic sidebands as it interacts with the audio input to the VCA. The function of Schmitt triggers, pitch to voltage converters, and the Omnipressor will radically alter the envelope.

4) **Reverberation and repetition echo.** Pianos are particularly effective with echo patches, the massive sound generation potential is amply multiplied by the echo . . . from slap to space. Perhaps the easiest way to obtain repetition echo is with a stereo, three head tape recorder. The closed-looped echo machines may feature variable repeat time but the frequency response is limited and the sound quality not too great. Newer designs incorporating the latest chips have much improved the quality of these effect boxes. Also, a filter with a repeating envelope will mimic the effect. The ideal would be to have a digital delay line (several and with adequate variable delays) . . . spring reverbs are not very efficient with pianos, taking away a great deal of presence.

5) **Ring modulation.** (RM). Assuming one of the inputs is the external keyboard, then if the other input to the RM is a low frequency oscillator, say a sine or triangle, the result will be amplitude modulation, tremolo . . . if the

modulating oscillator is then changed into the audio range, perhaps slowly sweeping towards the high frequency, some truly nice bells, sweeping modulations, and dissonances are possible, in this case the sidebands are dependent on the harmonic content of the input and modulating oscillators. Playing one note only (as you'll later see, more to come) affords interesting possibilities. If the VCO is tuned in unison with, say, A, then unison, octaves and fifths will yield more harmonic sidebands, which get progressively more dissonant as the harmonic interval being played becomes more dissonant. By routing the signal from an external keyboard to both inputs of the RM, octave splitting is realized (one note only). In the Serge system, both inputs to the RM may be voltage controlled (their respective amplitudes). The waveform of the modulating oscillator is all paramount, playing a piano chord when the other input is a low frequency square wave creates a plucked string effect most uncharacteristic to the acoustic piano.

6) **Location Modulation.** Depending on the musical content, its location may remain static as panned at the mixing board, or it may undergo change by manual or VC panning, perhaps by a joystick, both stereo and quad panners being available. The ARP 2600 and the Serge system both have what they respectively call an electronic switch or Bi-directional router, which reverse and mix triggering functions. This device allows the sequencing of two different inputs into one output, or, one input into two outputs, (see figure 2) every time that the trigger changes state (on or off). Every time a new trigger state is delivered to the module, one of the two audio sources is routed to the output in an alternating fashion. In the other mode it is used to locate an instrument into a particular speaker, alternating in a similar manner as above. The location of amplified and acoustic piano (when properly amplified) is a rich source of musical variety which seldom finds expression in contemporary concerts, no doubt because it would require a decent quad environment.

With the proper mixing board, it should be possible to assign the acoustic or electric keyboard so that its original sound is preserved and available in the audio path, and, to an output going to the synthesizer, where any further mixing of treatments would be carried out through its mixers.

### Dr. Philip Springer

Instructor, Electronic Music, UCLA Extension  
Author of "Switched On Synthesizer"  
is offering private instruction in

#### Electronic Music Composition

Private lab use included  
Moog, Arp, EMS and Serge systems  
Partial scholarships for qualified students

for information please call

(213) 454-5275



# SYNTHESIS

## MODULATION PART II: FAST MODULATION

with Danny Sofer

In the last article, I wrote about the application of modulation to various modules of a synthesizer for various results. I limited that article to frequencies below the range of audibility for reasons that will become apparent here. The patch diagrams from the previous article are applicable here as well, since only the frequencies have been changed.

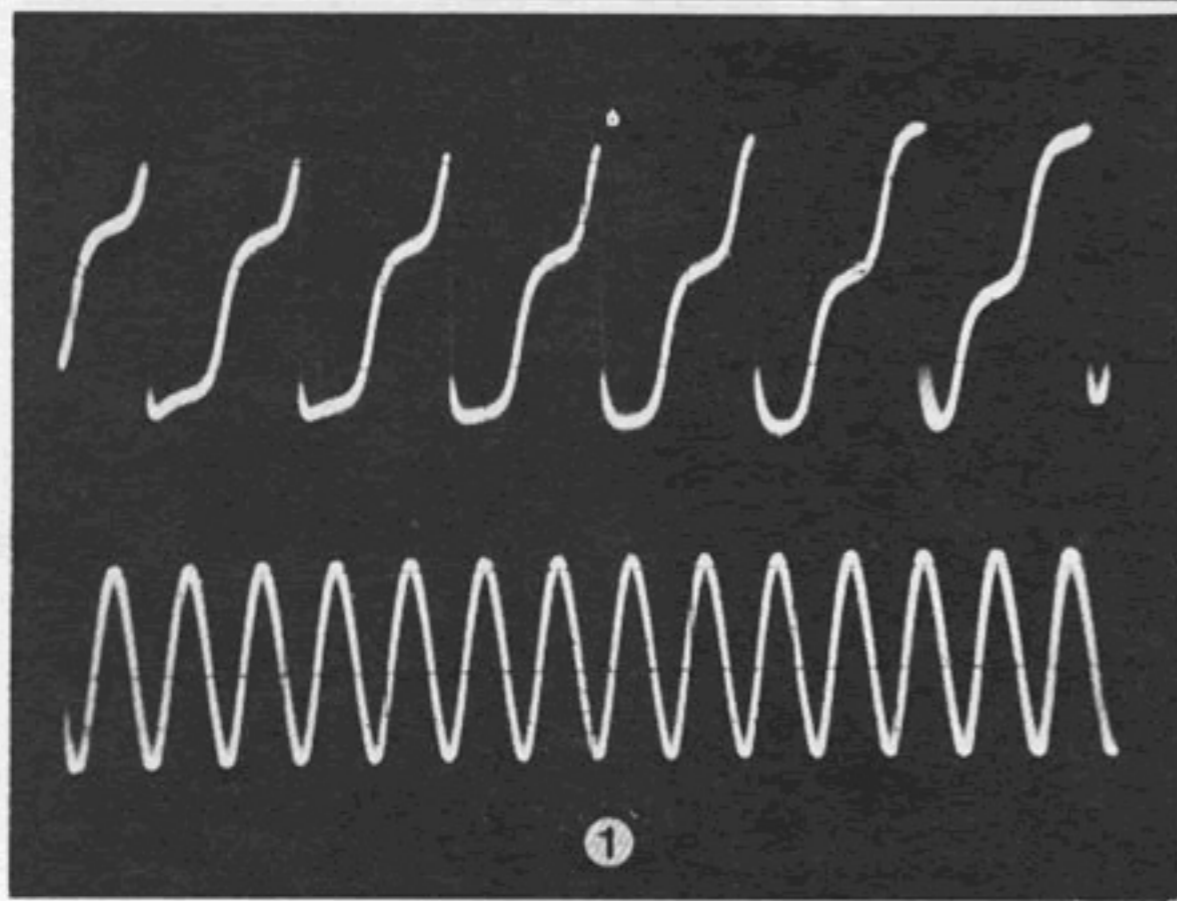

The difference in the effects of modulation below the range of audibility (below approx. 20 hz) and within the range of audibility can be compared to the process that give motion pictures their "motion." A motion picture consists of a series of still photographs, each slightly different than the one previous. If these photographs are displayed at a rate of two per second, the viewer will see precisely what they are; a series of still photographs, displayed one at a time. This slow projection of a motion picture can be compared to the effect of using a slow modulating oscillator to control, say, the pitch of another oscillator. Each cycle of the oscillator may be approximated by each frame of the movie.

Going back to the motion picture, by increasing the frequency that the pictures are displayed on the screen, a point is reached where the brain cannot distinguish between the individual photographs and perceives them as a blur, one continuous stream of motion. It is at this speed (16 frames per second, silent; 24 frames per second for sound films) that the pictures become motion pictures.

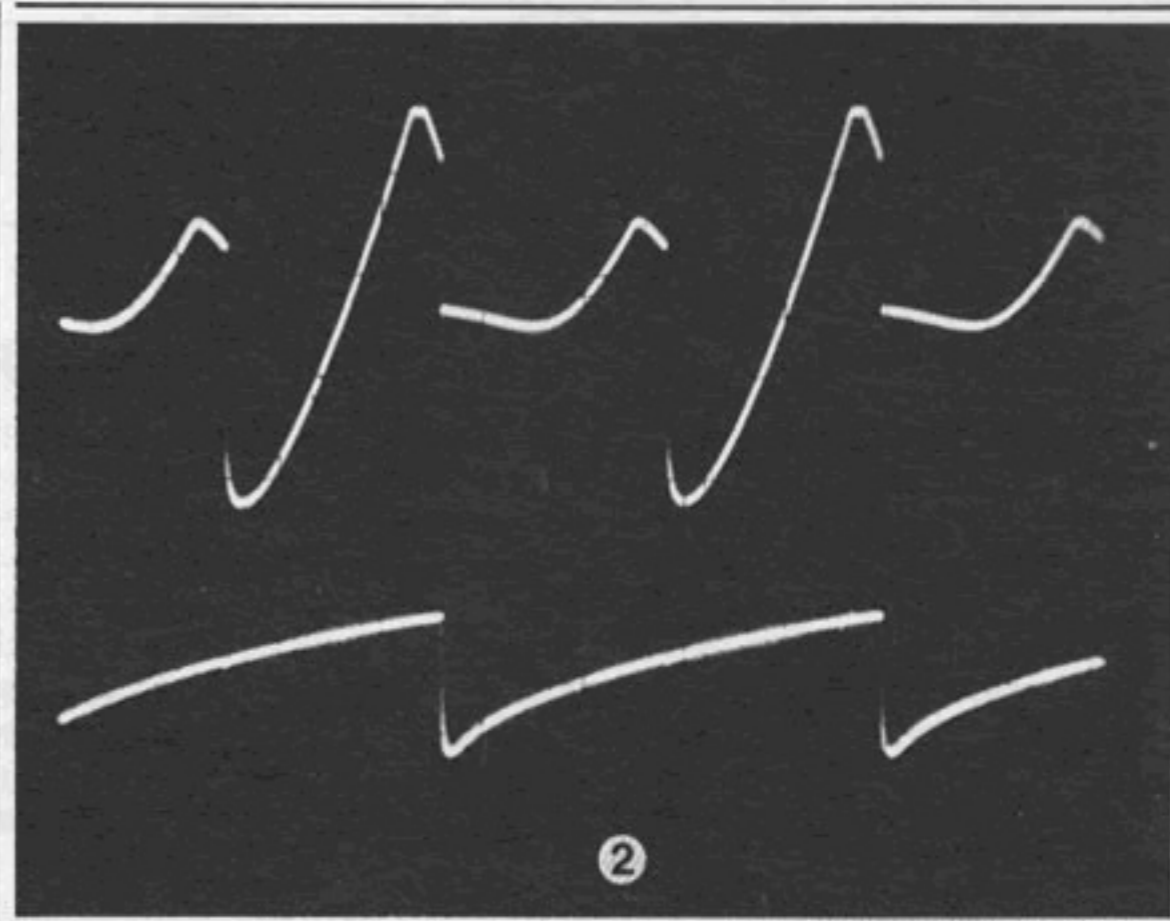

When the modulating oscillator in the example above is increased in frequency, a similar phenomenon takes place: the brain again cannot distinguish between individual cycles of the oscillator and perceives it as one continuous sound. Not only does the brain hear the tones produced by the frequency of both oscillators, but the sum and the difference of the frequencies as well. These two sidebands, as they were called, were not originally present in the sound sources, but neither was the motion in the pictures.

Sidebands may be achieved by several methods: *Frequency modulation*, *amplitude modulation*, and *ring modulation* are the most common.<sup>1</sup>

<sup>1</sup>Other methods include: filter modulation, pulse width modulation; and heterodyning which is the juxtaposition of two sounds of close frequency which will beat just because of their proximity to each other.

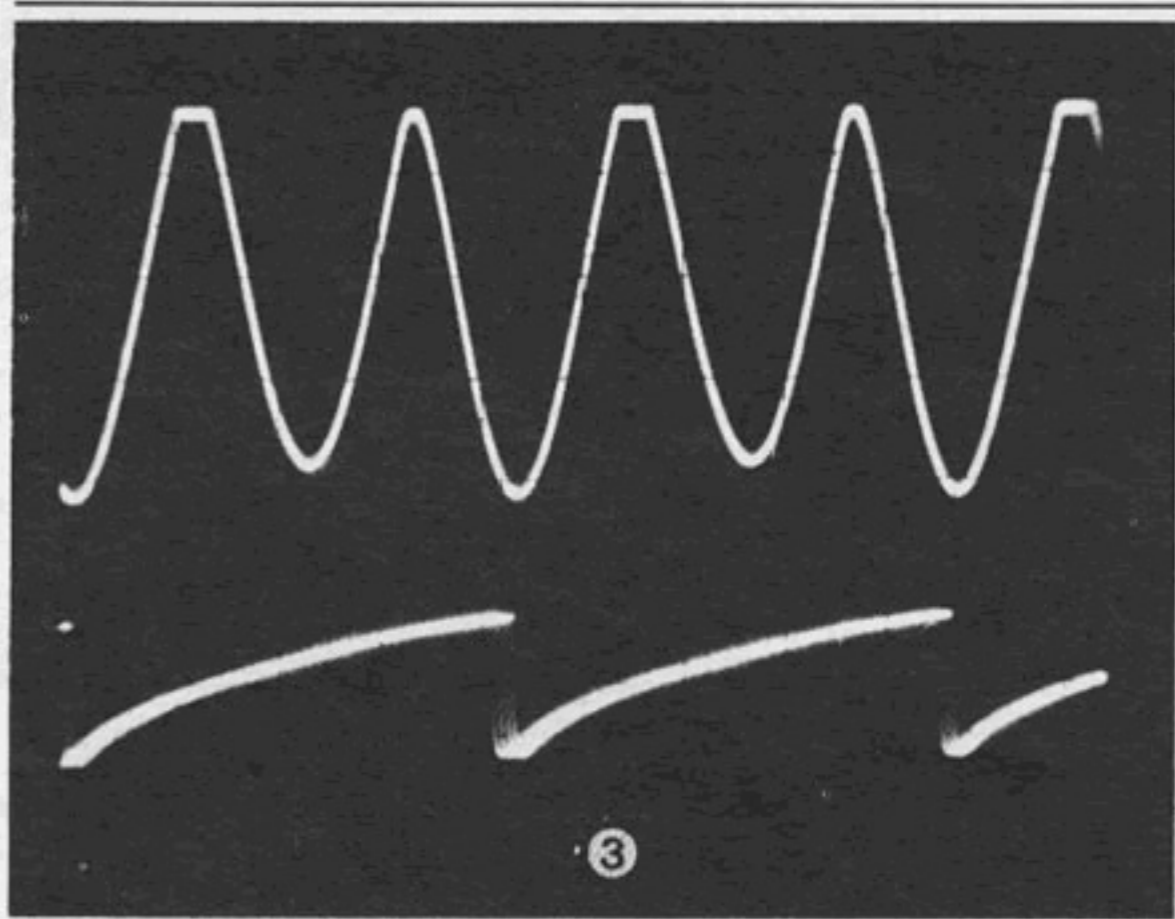



# HIGH POINTS AND HIGH JINKS IN THE HISTORY OF ELECTRONIC MUSIC

THE ACOUSTICAL STUDIES BEGAN IN CHINA IN 2800 BC, THE PROPHECIES IN ENGLAND, 1624 THE TECHNOLOGY-SWITZERLAND 1867, THE MUSICAL AESTHETICS ANYWHERE FROM 1660 "BUT TO PLAY OR HEAR ELECTRONIC MUSIC"



**1906**  
ELECTRONIC MUSIC AVAILABLE TO A SUBSCRIPTION AUDIENCE THROUGH TELEGRAPH WIRES FROM DR. THADDEUS CAHILL'S 200 TON "TELHARMONIUM"



**1920**  
PHYSICIST LEON TERMEN PRESENTS HIS NEW INSTRUMENT ("THEREMIN") AT THE 8<sup>TH</sup> SOVIET CONGRESS USING TWO HIGH FREQUENCY OSCILLATORS... ITS PITCH CAME FROM THE PROXIMITY OF THE PLAYER'S BODY TO THE RIGHT ANTENNA AND THE VOLUME, THE LEFT ANTENNA.



**1928**  
POEM SYMPHONIQUE FOR ONDES MARTENOT AND ORCHESTRA BY DIMITRI LEVIDIS PREMIERS AT THE PARIS OPERA... MAURICE MARTENOT PLAYS HIS MONOPHONIC INVENTION WHICH USED BEATING OSCILLATORS, AND HAD A KEY BOARD, SWITCHES, SPEAKERS A TURKISH GONG AND 24 SYMPATHETIC STRINGS AS RESONATORS



**1929**  
GIVELLET AND A COUPLE MAKE THE 1<sup>ST</sup> FULLY ELECTRONIC MUSIC SYNTHESIZER... THEY USED 4 OSCILLATORS WITH CIRCUITRY TO LINK THEM TOGETHER... A ROLL OF PUNCHED PAPER USED FOR CONTROLLING THE DEVICE....



**ALSO 1929**  
CON EVANSTON ILL., LAURENS HAMMOND ESTABLISHES THE ELECTRIC MUSIC CO. THAT WILL PRODUCE THE 2 MANUAL "HAMMOND ORGAN" (1935) USING ELECTRO-MECHANICAL SOUND GENERATORS THE 6 OCTAVE ONE MANUAL "NOVACHORD" (1938) A POLYPHONIC INSTRUMENT WITH 12 OSCILLATORS...



THE FOUNDATIONS WERE BEING LAID AND NO LESS THAN 4 GROUPS BECAME WELL PUBLICIZED SCHOOLS OF ELECTRONIC MUSIC IN THE 1950'S... THIS SERIES WILL DEVOTE AN INSTALLMENT TO EACH...



COMING SOON... "MUSIC CONCRETE" (FRANCE)... "ELECTRONISCHE MUSIK" (GERMANY)... "TAPE MUSIC" (USA) AND "MUSIC FOR MAGNETIC TAPE" (USA) [OR THE "UPTOWN" AND "DOWNTOWN SCHOOLS"]

## ART: JOHN ADAMS/STORY: BOB DAVIS

It is these sidebands that are most useful in obtaining a wide range of timbres not obtainable with wave forms of the traditional harmonic series. The harmonic series is necessary for the brain to perceive pitch, that is Ab, as opposed to highness or lowness of frequency. By injecting other frequencies into a sound wave the sense of pitch is destroyed and the resulting timbre has a new flavor all its own.

The associations of these timbres are primarily with the percussion section of an orchestra, and machinery of various types. Church bells, drums, airplanes, electric blenders, all produce this kind of sound.

Frequency Modulation is achieved by controlling an oscillator with another. The frequency of both oscillators as well as the amplitude of the modulating (controlling) oscillator will have a profound effect upon the sound as will the shape of both wave forms.<sup>2</sup> Figure 1 shows a saw tooth wave being modulated by the sine wave (top), the sine wave being shown by itself on the bottom. By slowly increasing the frequency of

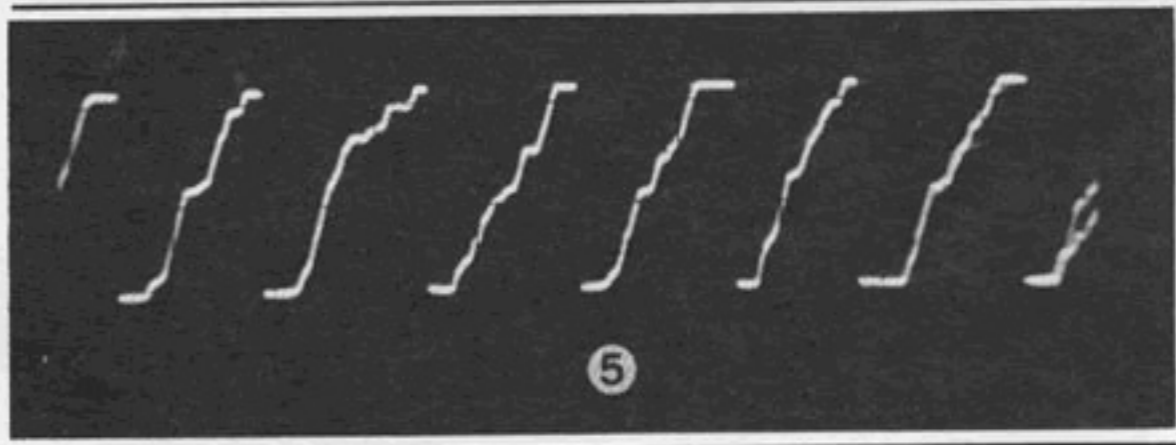

one of the oscillators, the resulting sidebands can be heard to change frequency in opposite directions, contributing to the confusion of the sound. This effect may be used constructively in the generation of engines of various types. Bells of varying "size" may be produced by modulating a sine wave with a sine wave.

Figures 2, 3 & 4 show a saw tooth wave being amplitude modulated, filter modulated, and ring modulated by another saw tooth wave. shown at the bottom. In *amplitude modulation*, the modulated (sometimes called carrier) oscillator is louder in proportion to the side bands than in *frequency modulation*, and for that reason may be more suited for "softer" modulated sounds. Modulating the filter frequency results in probably too little modulated sound for most uses, as the carrier comes through more or less intact (as shown by photo 3). In *ring modulation*, both the original signals are suppressed so that only the side bands come out.

Almost anything can be used for modulation: the voice, a sequencer (moving rapidly) a guitar, or pink noise (Figure 5). Experiment. An almost limitless selection of sounds can be achieved by modulation.

<sup>2</sup>When using a complex wave form (saw tooth or square, etc.) a pair of side bands will be generated for each harmonic.

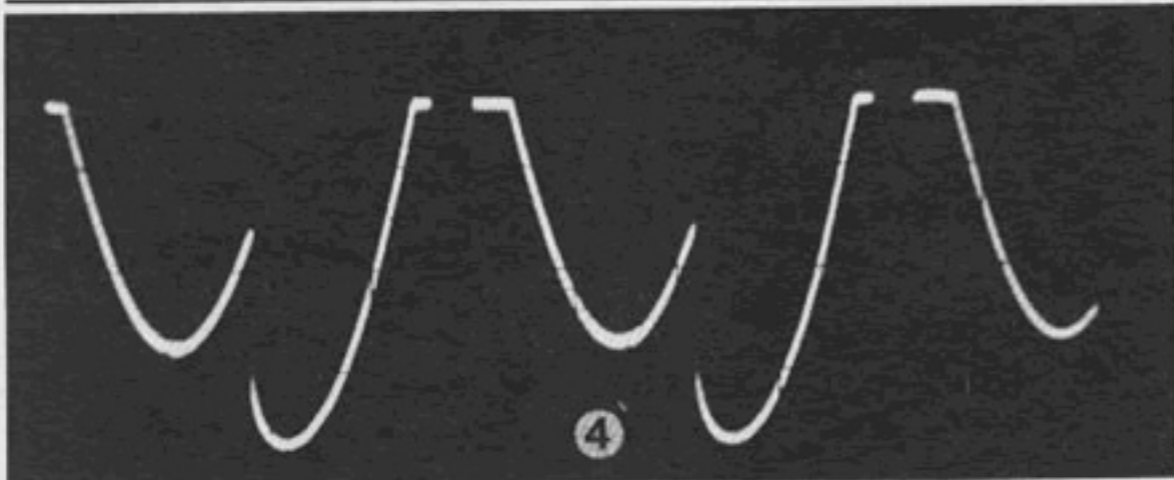



# ANALOG TO DIGITAL CONVERSION

with Peter Hillen

Now that we have completed the discussion on converting the digital information from a computer to an analog voltage for use by a synthesizer with a D/A converter, lets turn the problem around. A computer in an electronic music system not only must output analog voltages it must also be able to read them. Some sources for these voltages might be a keyboard, ribbon controller, pot, microphone or other analog transducer. The device which performs the task is an Analog to Digital Converter (what else!). The analog to digital converter (A/D) accepts analog voltage over a range of values and converts it to a binary number. The number of places in the binary number is dependant on the accuracy desired by the computer.

Accuracy can be thought of as how faithfully the digital output represents the analog input. The more places in the binary number at the digital output the closer the actual analog voltage it is. Consider the example of a 10 bit A/D converter. Assume it has the ability to measure analog input voltages from 0 volts to 10.24 volts. By choosing the maximum voltage as 10.24v each step of the 10 bit range becomes .01 volts ( $2^{10}=1024$ ,  $10.24v/1024$  steps = .01v/step). Now suppose the A/D converter is connected to a source and we wish to know what its voltage is. The source voltage may be 9.136 volts but the converter will read 9.14 volts because that is the closest step. The difference is the error. The largest error will occur when the analog input is exactly between two steps. For a 10 bit converter the maximum error would be a half a bit out of 1024 or  $.5/1024 \times 100 = .05\%$ .

The number of bits needed is application dependent. If an amplitude envelope is being measured, then a six or eight bit converter will do, because our ears are logarithmicly sensitive to sound and a small error is unnoticed. However if the converter is connected to a control voltage keyboard then 10 or 12 bits are needed to make the error undetectable by our ear. A discussion of a accuracy is also in the Computer Column of the Jan-Feb issue of Synapse.

As with its counterpart, the D/A converter, there are several different methods which can be used to accomplish the conversion. The method we will use is simple, straight forward and happens to be the most popular method in medium speed A/D converters. It is conversion by Successive Approximation.

There are only three elements necessary in a conversion using this technique; a D/A Converter, A voltage Comparator and finally a Successive Approximation Register. From previous articles we are familiar with D/A converters and we need not belabor the point more. The Voltage Comparator is new. It, as its name implies compares two analog voltages on its inputs. The output reflects which is greater by assuming the electrical equivalent if either a binary 1 (+ greater than -) or a binary 0 (- greater than +). Figure 1 shows the comparator output state for different input states.

Before describing the Successive approximation technique lets go through a conversion without it. The conversion takes place by applying the unknown analog voltage to one input of the Comparator and a known analog voltage to the other. The known voltage comes from the D/A converter. For the sake of this example we will assume that the unknown voltage is greater than zero and therefore the output of the comparator is binary one. The computer starts counting up one bit at a time. Each time the D/A converter is incremented the computer checks to see if the output of the comparator has changed (goes to binary 0). The counting then stops and the binary number is equivalent to the unknown voltage.

Very simple, but very slow. If the A/D is a 10 bit type then if the unknown analog voltage were at the top of the range there would be 1024 count and compare cycles. This is where the Successive Approximation technique comes in. With Successive Approximation only 10 count and compare cycles are needed. It is accomplished by making better choices of what to compare to the unknown voltage. At the start of the conversion cycle the most significant bit of the binary word going to the D/A converter is set to 1. The number formed is equal to half of full scale. The comparator makes the decision as to which of the two voltages is greater. Regardless of the outcome we now know which half of the full range the unknown voltage is in and do not

ILLUSTRATIONS BY SUE DENIM/AND GRAPHICS

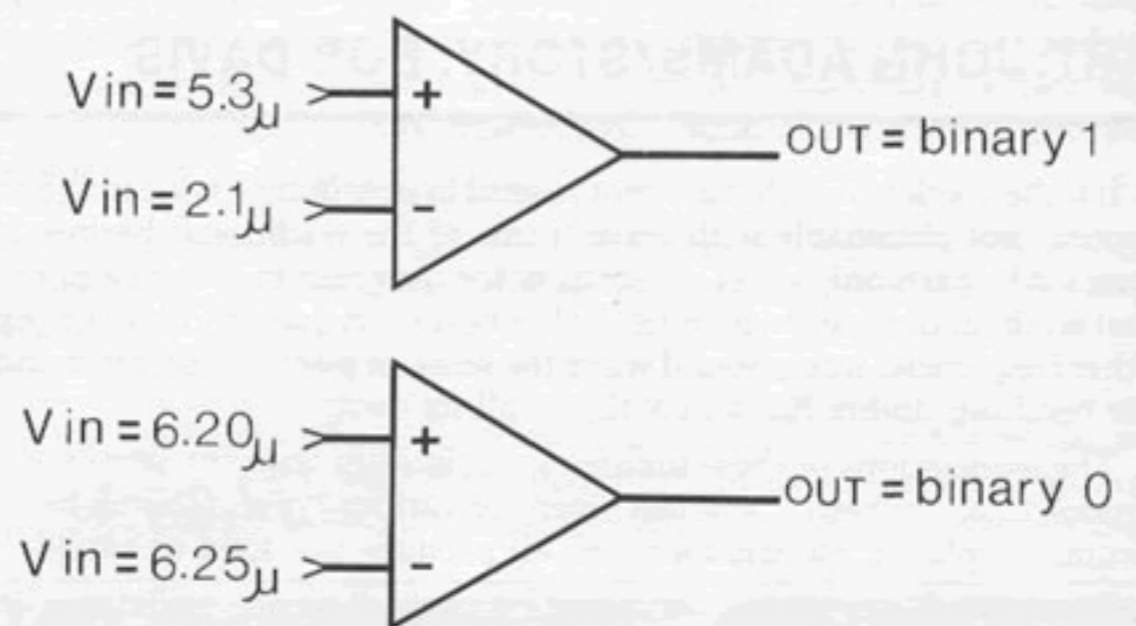

Figure one: Voltage comparators with different input conditions

have to pursue the other half. In a 10 bit A/D converter this means elimination of 512 count and compare cycles. Depending on which half of the scale the unknown voltage is in, the most significant binary bit is kept as a one or returned to a zero.

In effect we are building a binary number starting with the most significant bit and working down. The next step is to take the next most significant binary bit and so the same thing which puts the unknown voltage somewhere in one quarter of full scale. This process continues until all bits in the converter have been tested. The result is a binary number equivalent to the analog input. The electronic hardware which accomplishes the Successive Approximation is called a Successive Approximation Register. Figure 2 shows the block diagram of how it works with the D/A converter and Comparator.



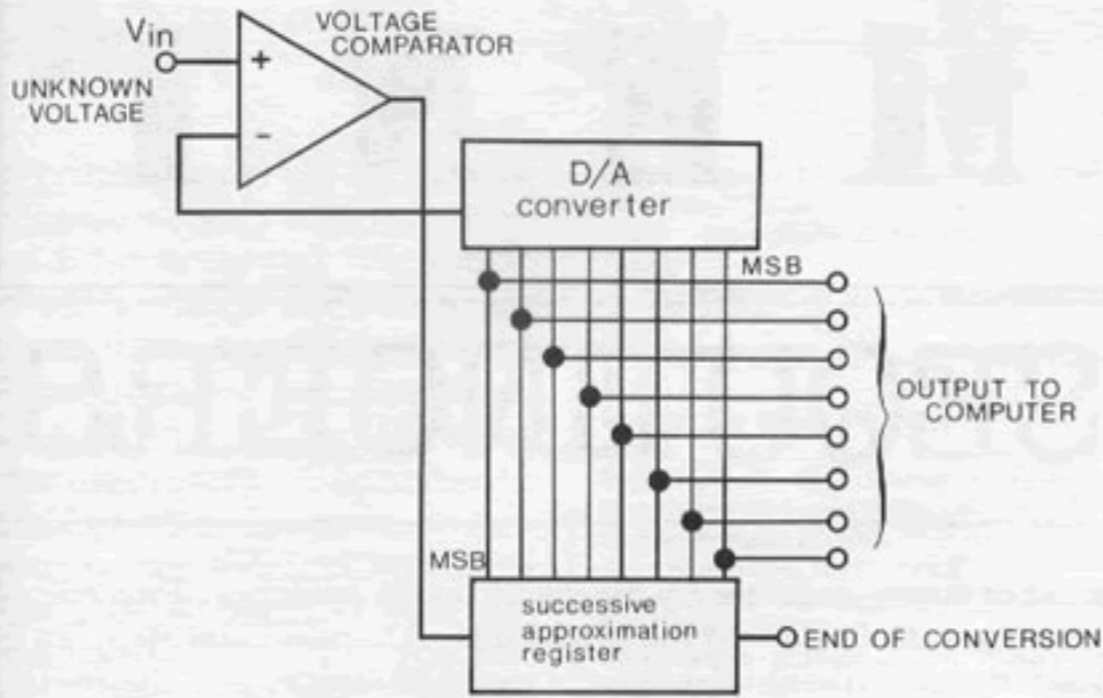

Figure two: Basic block diagram of successive approximation A/D system.

Successive Approximation could be done by the Computer but it takes away from the computers processing power. Most A/D converters include the Successive Approximation Register. All the computer has to do is monitor an End of Conversion signal to see when valid data is on the output and then read the data.

Next time we will explore another form of A/D converter error and see how a Sample and Hold circuit can cure it. ~~~~

**Synapse**

## POP WORKS

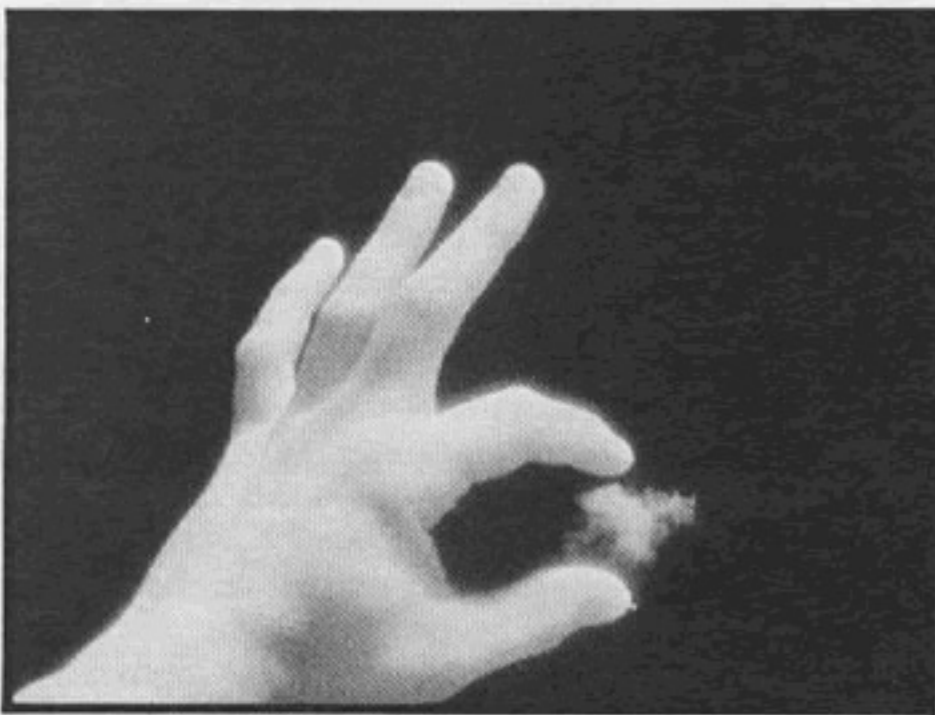

**fine arts & other fine  
PHOTOGRAPHY  
bill matthias - los angeles  
213/986-3951**

# ATTENTION RETAILERS:

**Synapse  
is  
available  
at  
bulk  
rates  
for  
retail  
sales**

## Contact:

**Synapse  
Retail Sales  
(213) 383-7933  
2829 Hyans Street  
Los Angeles  
California  
90026**

**Synapse**



# EQUIPMENT

## FOUR DIGITAL SEQUENCERS

with Tom Davey

The digital sequencer is the most sophisticated control module the average synthesist is likely to encounter at present. The more stupefying models may cost as much as \$6,000, and require the attentions of a modular synthesizer or a recording studio to coax out the full subtleties of their performance. However, they are not difficult to comprehend, only sometimes cumbersome to operate, due simply to the sheer number of operations options open to the performer. Few artists have mastered the digital sequencer in public; indeed, they are seen on stage more infrequently even than less versatile analog sequencers.

### Oberheim DS2a

The best of the basic models is the Oberheim DS-2. Like all the digital sequencers discussed in this article, the Oberheim will satisfactorily do the following things:

Remember a sequence of up to 256 steps in two parameters (usually pitch and duration);

Play back the sequence up to sixteen times as fast or slow;

Will give a digital readout of the sequence position;

Will provide for manual, one-step-at-a-time advancement of the sequence;

And provide a means for dividing the overall sequence into independently retrievable sub-sequences.

On the Oberheim, three sub-sequences are available or up to eighty-five sets apiece. Also available are switches that enable the sequence to be transposed to three different intervals pre-selected by the performer. This feature, which few digital sequencers share, obviously enhances the harmonic utility of the DS-2 and points out the fact that this unpretentious machine is best partnered with mini-systems playing tonal music in situations not demanding extravagant control functions.



Sequential Circuits Model 800

The Model 800 sequencer from Sequential Circuits was designed with live performance at least partly in mind. The Model 821 footpedal initiates start/record, stop/record, and clock on/off functions. On the instrument itself the clock speed can be exactly halved or doubled during playback, or, the clock can be externally driven for precise synchronization with, say, a click track. Especially useful are the 16 sub-sequencers of 16 steps apiece; the sub-sequences can be instantly

selected or strung together by means of toggle switches. Two editing functions are designed into the Model 800. An individual step can be reprogrammed without affecting the entire sequence, and the rhythm can be reprogrammed without affecting the pitch values.

### EMS Synthesizers 256

Although almost no digital sequencer comes complete with its own synthesizer (the exception being the Synthesizer AKS from EMS), there is one that comes with its own generous five-octave keyboard: the Synthesizer Sequencer 256, also from EMS. The keyboard, being velocity sensitive, translates the pressure with which a key is struck into a voltage, thus enabling the instrument to control three parameters: pitch, duration and amplitude.

The Synthesizer 256 was originally designed as a modular component of the Synthesizer 100, EMS' monster modular system. Unfortunately, there is only one in the whole United States, and I was unable to personally examine it. I presume it works. However, it is a sophisticated instrument and some of its more felicitous features deserve mention. Besides the velocity sensitive keyboard, it has:

A "slew limiter", or portamento between voltage steps;

Three sub-sequences, of any length, whose voltages can be processed (+) right on the instrument itself;

A special pulse track that can be separately programmed to play along with the main (3 parameter) sequence;

An external clock input, and a voltage output whose level changes in proportion to the clock rate;

And various editing controls, such as "clock stop at event start", "clock stop at event stop", and "erase current event."

### THINC MMC-1

One last digital sequencer is the MMC-1 from THINC (Technical Hardware, Inc.). This is an instrument for the true digital aficionado. An optional accessory of the THINC, and the DS-2, is a circuit board designed for hardware installation into your own synthesizer. The MMC-1 and the DS-2 together become practically a mini-programmer for your system, able to control seven different modules at once. To detail every functional nuance of which the THINC is capable is beyond the scope of this article, although the hefty but admirable 40-page instruction manual that comes with each instrument certainly tries. Suffice to say that the THINC includes most features present on the other sequencers and a few more besides. All switches are touch sensitive, and a digital display indicates event number, control function, gate status, octave status (the MMC-1 has an octave transposition switch), and tempo. An "index" switch allows rapid access to any single event, while three dry cells retain the memory when the unit is unplugged. The MMC-1 comes with its own touch sensitive keyboard, but this is actually a drawback; since the keyboard range is only a little over one octave, this generally limits the sequences of the THINC to control functions rather than wide ranging melodic runs.

List prices for the four machines reveal wide variation in cost effectiveness. At \$795 and \$1195 respectively, the model 800 from Sequential Circuits and the MMC-1 from THINC can only be rated bargains. Considering its more modest range of functions, the Oberheim DS-2 is slightly overpriced at \$1295. However, the \$6,040 list for the Synthesizer Sequencer 256 from EMS is simply outrageous; no wonder there is only one in the whole of the United States. Lopping \$4500 off its list would make it a tad more competitive. ~~~



# LISTINGS

In order to provide a comprehensive service to the reader, we have enlarged the scope of our Listings section to include these headings: Sound Reproduction, Accessories, in addition to Synthesizer Manufacturers, Consultants and Schools. Synapse invites you to use the Listings as a resource to support your activities and asks that you forward the name and address of any company that you feel we have overlooked.

## SYNTHESIZERS

### MANUFACTURERS

**Advanced Tools for the Arts**, P.O. Box 825, Tempe, Ariz. 85281  
**Analog/Digital Associates**, 2316 Fourth St., Berkeley, Cal. 94710  
**Aries Music Inc.**, P.O. Box 3065, Salem, Mass. 01970  
**ARP Instruments**, 320 Needham St., Newton, Mass. 02164  
**John Blacet\***, 4019 Chico Ave., Santa Rosa, Calif. 95401  
**Buchla**, Box 5051, Berkeley, Calif. 94705  
**CFR Associates\***, Box F, Newton, N.H. 03858  
**Computone Inc./Lyricon**, P.O. Box 433, Norwell, Mass. 02061  
**Concert Company\*\***, 3318 Platt Avenue, Lynnwood, Calif. 90262  
**D.B.L. Electronics**, 502 Sherman, Canton, Mass. 02021  
**Dennis (Electronic Music Components)** 2130 Metcalf, Honolulu, Hawaii 96822  
**Electrax**, P.O. Box 149, Tarzana, California 91356  
**Electron Farm/Harvest** Gregory Kramer, 135 W. Broadway, New York, N.Y. 10013  
**Electronic Music Laboratories**, P.O. Box H, Vernon, Conn. 06066  
**Electronic Music Studios**, The Priory, Great Milton, Oxford, England  
**E-mu Systems**, 3046 Scott Blvd., Santa Clara, Calif. 95050  
**Farfisa**, 1330 Mark St., Elk Grove Village, Ill. 60007  
**Galaxy Systems**, P.O. Box 2475, Woodland Hills, Cal., 91364  
**Gentle Electric**, 119 Brainerd Rd., No. 15, Allston, Mass. 02134 (617) 732-4844  
**Heuristics, Inc.**, 900 N. San Antonio Rd., Los Altos, Cal., 94022  
**Inner Space Electronics**, Box 308, Berkeley, Cal., 94701\*  
**Ionic Industries**, 128 James St., Morristown, NJ 07960  
**Korg/Univox**, 75 Frost St., Westbury, N.Y. 11590  
**Logistics**, Box 9970, Marina Del Rey, Cal. 90291  
**MM Electronics, French's Mill**, French's Rd., Cambridge, England CB4 3NP  
**Moog/Norlin**, 7373 North Cicero Ave., Lincolnwood, Ill. 60466, Customer Service: Box 131, Academy St., Williamsville, N.Y. 14221  
**Musicomputer**, 15, 112 W. Sierra Hwy., Canyon Country, California 91351  
**Music Technology/Crumar**, 105 Fifth Ave., Garden City Park, N.J. 11040  
**Musitronics Corporation**, Sound Lab 10, Rosemont, N.J. 08556  
**Oberheim Electronics**, 1549 Ninth St., Santa Monica, Calif. 90401  
**Octave Electronics Inc.**, 35-73 Steinway St., Long Island City, N.Y. 11103  
**Octron**, 1346 Bayport Avenue, San Carlos, Calif. 94070  
**Omniphon**, Box 166, Churchill Rd., Mason, N.H. 03048

**Oznie Process Electronics**, Box 7, Centerville, Penn. 16404  
**PAIA\***, Box 14359 Oklahoma City, Okla. 73114  
**Pollard Industries, Inc.**, 9014 Lindblade St., Culver City, Cal. 90230  
**Polyfusion Inc.**, 160 Sugg Road, Buffalo, N.Y. 14225  
**Rolandcorp U.S.**, 2401 Saybrook, L.A., Cal. 90040  
**Sequential Circuits Company**, 7150 Rainbow Drive No. 7, San Jose, Calif. 95129  
**Serge Modular Music**, 1107 1/2 N. Western Ave., Hollywood, Calif. 90029  
**Software Technology Corp.**, P.O. Box 5260, San Mateo, Cal. 94402  
**Solid State Music**, 2102A Walsh Ave., Santa Clara, Cal. 95050\*\*  
**Star Instruments Inc.**, Box 71, Stafford Springs, Conn. 06076  
**Steiner-Parker**, 2258 South, 2700 West, Salt Lake City, Utah 84119  
**Strider Systems**, P.O. Box 2934, Norman, Okla. 73070  
**Syn-Cordian**, 32-73 Steinway St., Long Island City, N.Y. 11103  
**Syn-Key**, 114 W. Hintz Road, Wheeling, Ill. 60090  
**THINC-Technical Hardware Inc.**, P.O. Box 3609, Fullerton, Calif. 92634  
**VAKO Synthesizers Inc.**, 4651 82nd Avenue North, Saint Petersburg, Florida 33565  
**Wavemakers**, P.O. Box 27, Edmonds, Wash. 98020  
**Yamaha International**, Box 6600, Buena Park, Calif. 90620  
**360 Systems**, 2825 Hyans Street, Los Angeles, Calif. 90026

Note: \* manufacturer makes kits only  
\*\* manufacturer makes both kits and finished product

### CONSULTANTS

**Audio Designs**, 3422 Brookfield Ln., Decatur, Georgia 30032 (404) 284-8651  
**Michael J. Boddicker**, (213) 985-0010  
**Boston Experimental Electronic Music Projects**, Robert Ceely, 33 Elm St., Brookline, Mass. 02146, (617) 731-3785  
**Clean Music Systems**, Vince Ciamarra, 194 Henderson, Kenmore, N.Y. 14217 (716) 874-1847  
**Different Fur Music**, John Vieira, 3470 19th St., San Francisco, Calif. 94110, (415) 863-WAVE

### CLASSIFIED ADS

20 WORDS FOR \$2.00

TO: SYNAPSE

CLASSIFIED ADS

2829 HYANS STREET

LOS ANGELES, CALIF. 90026

Glider by French Lick. A fusion of space rock, electronics and sex in the tradition of early Pink Floyd, King Crimson and Gong. A collector's L.P. from Los Angeles Underground. Send \$5.00 to: John Willoughby, 517 S. Palm Dr., Brea, Cal. 92621.

FREE MUSIC CATALOGS!  
Greatest music books! Hundreds! Top 40, Jazz, oldies, Fake Books. IMPERIAL, Box 66-SY, New York City 10022

**Disco Tech Musical Electronics**, Prospect Mall, 2239 North Prospect, Milwaukee, Wisconsin 53202, (414) 271-9291  
**Dorje Sound**, Chet Wood, P.O. Box 2232, Berkeley, Calif. 94702  
**DS Music**, 811 Franklin St., Santa Monica, Calif. 90403, (213) 463-8772  
**EMSA (Electronic Music Studios of America, Inc.)**, 269 Locust St., Northampton, Mass. 01060, (413) 586-3777  
**Entropy West Electronics**, Eric Valinsky, 1242 Harvard St., Santa Monica, Calif. 90404, (213) 828-0389  
**Electronic Music Studio**, Dwight D. Gattwood, Director, University of Tenn., Martin, Tenn. 38238, (901) 584-7402, 587-2281  
**Exploratory Electronic Music**, Steven C. Bilow, 16685 Calneva Drive, Encino, California 91436, (213) 789-6885  
**Michael Gilbert**, 88 Beacon Street, No. 14, Somerville, Mass. 02143  
**Lectron Music Lab**, Box 1594, Hollywood, Calif. 90028  
**Sound Arts**, 2825 Hyans St., Los Angeles, Calif. 90026 (213) 487-5148  
**Stan Levine**, 13508 Debell St., Pacoima, Calif. 91331, (213) 899-7223  
**Paradox EMS, Inc.**, 116 West Broadway, Vancouver, B.C., Canada V5Y 1P3  
**Patchwork Sound**, Jack Howe, 14759 Hesby St., Sherman Oaks, Calif. 91403  
**People's Computer Company**, P.O. Box 310, Menlo Park, Calif. 94025  
**PI Corporation**, 1741 East 24th St., Cleveland, Ohio 44114, (216) 781-2207  
**Ron Rivera**, 48 Brighton Avenue, No. 11, Allston, Mass. 02134  
**Dr. Philip Springer**, Box 1174, Pacific Palisades, Calif. 90272, (213) 454-5275  
**Star Track Recording Studio**, 8615 Santa Monica Blvd., Los Angeles, Calif. 90069, (213) 855-1171  
**Carter Thomas**, Manpel Road, Spring Glen, N.Y. 12483 (914) 647-9121  
**TNY Music & Engineering**, Route 4, Deerpark, N.Y. 12144, (518) 283-2837, 283-2899

### SCHOOLS

**Boston School of Electronic Music**, 326 Dartmouth Ave., Boston, Mass. 02116, (617) 261-1634  
**Con Tempo Music Guild**, 13273 Ventura Blvd., Studio City, California 91604 (213) 784-8271

ELECTRONIC MUSIC Compositions: "STRATTI", "VONCE", "LA FLEUR LES FLEURS", masterfully created by Robert Ceely. Realized in the Milano, BEEP, and MIT-SYN at M.I.T. studios. A necessary addition to any collection. For stereo L.P., send \$6.18 to: Jon Dattoro, Box No. 422, 12 Stoneholm St., Boston, MA, 02115.

EMSA reconditions and sells used synthesizers at fair prices. Used equipment also accepted on consignment. VSC3 and DK1 (\$800); ARP Axxe display model (\$625); ARP Odyssey with Anvil case (\$1100). 269 Locust, Northampton MA 01060. (413) 586-3777

**James D. Craig Music**, 511 Cedar St., Allentown, Penn. 18102 (215) 437-4743  
**Dick Grove Music Workshops**, 12754 Ventura Blvd., Ste. 2, Studio City, Calif. 91604  
**Los Angeles Center for Electronic Music**, 8615 Santa Monica Blvd., Los Angeles, Calif. 90069 (213) 652-7655, 463-8772  
**Sherwood Oaks Experimental College**, 6353 Hollywood Blvd., Hollywood, Calif. 90028 (213) 462-0669

### SOUND PRODUCTS & ACCESSORIES

**Alembic**, P.O. Box 759, Sebastopol, Calif. 95472 (707) 823-8579  
**Barcus-Berry**, 15461 Springdale St., Huntington Beach, Cal. 92649  
**E Bow/Heat Sound Products**, 611 Ducommun St., Los Angeles, Calif. 90012 (213) 687-9946  
**Electro-Voice**, 674 Cecil St., Buchanan, Mich. 49107  
**Eventide Clockworks, Inc.**, 265 West 54th St., New York, N.Y. 10019 (213) 581-9290  
**FRAP**, Box 40097, San Francisco, Calif. 94140 (415) 824-2223  
**FROGG (Design Engineering Labs Inc.)**, 4121 Redwood Ave., Los Angeles, Calif. 90066 (213) 823-8220  
**Hammond**, 4200 Diversey, Chicago, Ill. 60639  
**Heil Sound Systems**, Heil Industrial Blvd., Marissa, Ill. 62257  
**Inflithatre Inc.**, 4990 Mass Ave., Indianapolis, Ind. 46218  
**Mellotron/Dallas Music Industries**, 301 Island Road, Mahwah, N.J. 07430 (201) 327-6300  
**Morley Electronics**, 2301 West Victory Blvd., Burbank, Calif. 91506 (213) 843-7122  
**Pro Sound**, 13717 S. Normandie, Gardena, Cal.  
**Rothchild Musical Instruments** (distributor Furman and Alembic products), 65 McCoppin St., San Francisco, Calif. 94103 (415) 626-2260  
**Sennheiser Electronic Corp.**, 10 West 37 St., New York, N.Y. 10018  
**TAPCO**, 405 Howell Way, Edmonds, Wash. 98020 (206) 775-4411  
**Wasatch Music Systems**, P.O. Box 9175, Salt Lake City, Utah 84109

### SOUND RECORDING

**Ampex**, 401 Broadway, Redwood City, Calif. 94063 (415) 367-4544  
**dbx Incorporated**, 296 Newton St., Waltham, Mass. 02154 (617) 899-8090  
**Dokorder**, 5430 Rosecrans Ave., Lawndale, Calif. 90260  
**Dolby Laboratories Inc.**, 731 Sansome St., San Francisco, Calif. 94111 (415) 392-0300  
**Furman Sound**, 616 Canal Street, Suite 25, San Rafael, California 94901 (415) 456-6766  
**Magnetic Reference Laboratory Inc.**, 229 Polaris Avenue, Suite 4, Mountain View, Calif. 94043 (415) 965-8187  
**Maxell Corporation of America**, 130 West Commercial Ave., Moonachie, New Jersey 07074  
**Orban/Parasound**, 680 Beach St., San Francisco, Calif. 94109 (415) 673-4544  
**Otari Corporation**, 981 Industrial Road, San Carlos, California 94070 (415) 593-1648  
**Scientific Audio Electronics Inc.**, P.O. Box 60271, Terminal Annex, Los Angeles, Calif. 90060  
**Scotch/3M Magnetic Audio/Video Products Division**, 3M Center, Saint Paul, Minn. 55101  
**Shure Brothers Inc.**, 222 Hartrey Avenue, Evanston, Ill. 60204  
**Scully Recording Instruments**, 475 Ellis St., Mountain View, Calif. 94943  
**TDK Electronics Corporation**, 755 Eastgate Blvd., Garden City, N.Y. 11530  
**TEAC Corporation of America**, 7733 Telegraph Road, Montebello, Calif. 90640  
**Telex Communications Inc.**, 9600 Aldrich Avenue South, Minneapolis, Minn. 55420



# What's Happening

from page 7

features a special Hex [six independent channels] pickup for the guitar. The unit works by pitch to voltage conversion and the strings [straight or synthesized] can be split between stereo outputs. The Avatar is expected to list for \$2500. The Centaur is a polyphonic [six voice] guitar synthesizer that also works on pitch to voltage conversion. Final release dates for both instruments are not yet available.

The success of the recent Tangerine Dream tour of this country was such that their next tour starts early in July. Laserium will once again be involved but at press time the details were not set.

self contained sound processing systems.

Two new products from Analog/Digital Associates of special interest to the reader are the Flanger and Harmonic Synthesizer II. The \$199.95 Flanger can be switched between even and odd harmonic emphasis and will accept a zero to fifteen volt control voltage or the A/DA control Pedal A[\$39.95] to control the sweep. The Harmonic Synthesizer II is capable of transposing any musical note or chord to any interval within it's three octave range with delay to 180 ms. Octave dividing, key modulation, harmony, blending, vocal doubling, simultracking, overtone enhancement, ascending/descending scales or chords,

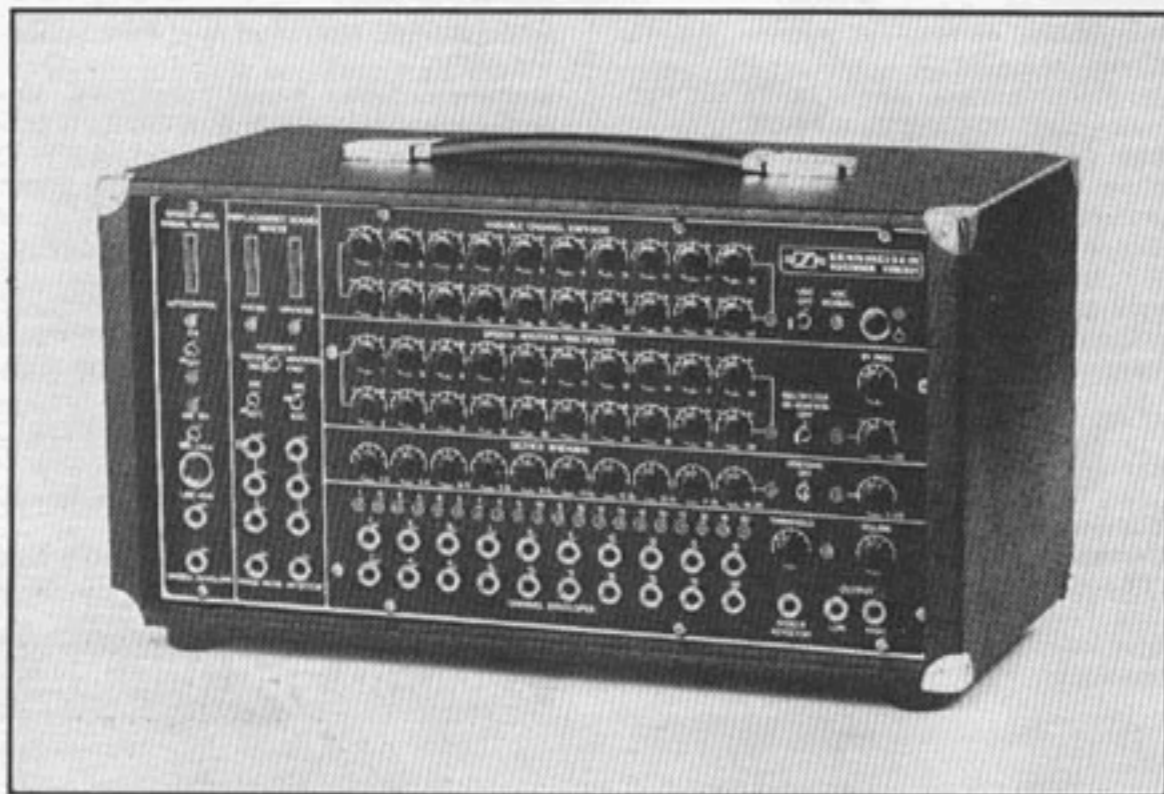

Sennheiser VSM201 Sound Effect Vocoder.

Malatchi Electronic Systems and Automated Lighting Concepts have released Alice, a programmable stage light controller. Alice is a four channel system that allows pre-setting of three programs as well as manual control and four channel fade delay. The controller lists for \$799 and a system including Alice, remote control footswitch and light box sells for \$1137. For information, write: Malatchi Electronic Systems Inc., 3731 E. Colfax, Denver, Colo., 80206

A company that is not new to this business but may be new to you is Wavemakers of Edmond, Washington. They manufacture a line of synthesizers as well as

echo, delay and glissando are some of things you can do with this \$465 instrument.

Star Instruments Inc. has released their second product, the Synare 2 Computer Controlled Percussion Synthesizer and Sequencer. It features an array of sound producing and processing modules and a micro-computer controlled sequencer which will record in real time and play back so the user can create complex rhythms. Twelve playing pads can be tuned to any of seventy-two pitches and octave pads allow the twelve playing pads to be transposed by touch. Of special interest is that all sound sources are generated by the



Korg PS-3300 modular polyphonic synthesizer.

computer.

Two new polyphonic synthesizers have been released by Unicorn Inc. The Korg PS3100 is a fully polyphonic synthesizer in which each note has it's own VCF and VCA. Six waveforms are available from the Modulation Generator and a Polyphonic Sample and Hold is also featured. Unlike most polyphonic synthesizers, patching is allowed on the face panel. The PS3100 lists for \$2995. The Korg PS-3300 is a modular polyphonic system composed of three PSU-482 modules and one PSU-483 module. PSU-482 modules feature signal generators, low pass filters, envelope modifiers, resonators, amplitude modulator, and two modulation generators. The PSU-483 module features mixer with VCA, sample and hold, envelope generator and voltage processors. As with the PS3100, patching is allowed and many inter-connections are possible between the two systems. The PS3300 lists for \$7500 with remote keyboard.

Roland will soon release the MC-8 Microcomposer. The MC-8 functions as an eight voice digital memory that can instruct



Roland GR-500 Guitar Synthesizer.

a synthesizer with discrete vol-

tages and can be clocked to play back it's memory in sequence. An A/D converter allows programming with external sources such as a keyboard in addition to the calculator type keyboards on the unit's front panel. Programs can be permanently stored on tape and re-entered at a later time. The basic \$4500 unit comes with 4k of memory and can be expanded to 16k. Also new from Roland is the GR-500 Guitar



Alice programmable stage light controller.

Synthesizer. The synthesizer portion has five main sections. The polyensemble section is utilized to simulate ensembles of string, brass, and woodwinds. The Bass section is assignable to various guitar strings and will perform bass doubling. Similar to a keyboard synthesizer is the Solo Melody Section. The External Synthesizer Section allows the control of an additional synthesizer. List is \$2000.

Sennheiser has released the VSM201 Sound Effect Vocoder. The unit features twenty channels of filters with a spectral range of 100 Hz. to 8000 Hz. Stevie Wonder is rumored to have purchased the proto-type. The unit lists for \$10,880



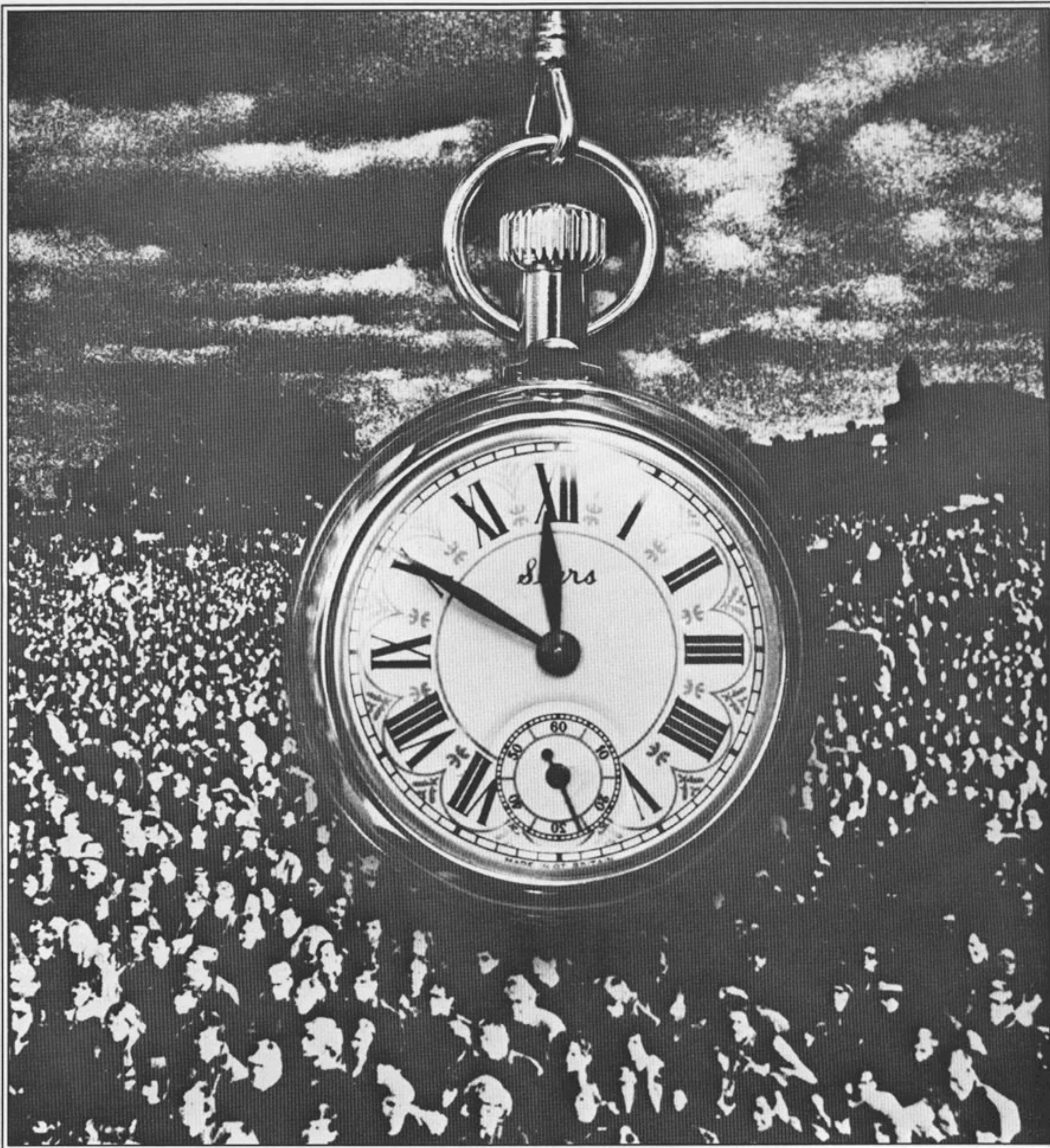

BILL MATTHIAS

## Isn't it about time you subscribed to Synapse?

A one year/six issue subscription is \$6.00, or \$7.50 if you live outside the US. All payments must be in US funds. Money orders are recommended as payment by foreign subscribers. For the current issue only, send \$1.25 plus 50 cents to help defray the expense of first class postage. Use the enclosed postage-paid envelope or send to: **Synapse/Subscription Dept. 22**, 2829 Hyans Street, Los Angeles, California 90026.

**Synapse**



THIRD CLASS MAIL

BULK RATE  
U. S. POSTAGE  
PAID  
No. Hollywood, CA  
PERMIT NO. 456



# Synapse

