

international electronic music

Synapse

Volume 2, Number 5
March/April 1978
USA & Canada \$1.50

Michael Hoenig

*Towards a
Universal Music*



Edgar Froese

*Tangerine Dream
Regroups*

Jean-Claude

Rissett *On IRCAM-
Boulez' Brain Child*

Home Production

Making Tracks

Patch Notation

Down to the Bottom Line



WE BEAT TIME & SPACE

NO STRINGS ATTACHED!

It's the greatest advance in electric instruments since Les Paul... there's now no need for a cord between your instrument and its amp.

Schaffer-Vega Diversity Systems, for all instruments and hand-held mics guarantee a minimum 100 yard performing range, give complete protection against electric shock, and — — — it's no gimmick — — — make no compromise in your sound.

Since June, over 50 major bands have gone wireless, and every one of them has done it with SVDS — — — EVERY ONE of them.

We're already standard performing equipment for Stephen Stills, Kiss, Steve Miller, Ted Nugent, Foreigner, Peter Frampton, Heart, Derringer, AC/DC, America, Commodores, Nektar, Mahogany Rush, E.L.O., Peter Gabriel, Fifth Dimension, Earth Wind & Fire, The Beachboys, and Thin Lizzy.

Get rid of the limitations of cords for once and for all... you can enter the house from behind, playing all the way, and never get shocked again.

Call... or send \$1 for complete specs.

SVDS instrument systems: \$3300.
Operating Manual: \$5

The instantly famous Schaffer-Vega Diversity System gives you control of space---and lots of new performing possibilities.

Less than half a mile from the womb that spawned SVDS is the nest of Eventide: the world's foremost manufacturer of exotic time domain modifiers. So we're also the one stop you can make to master time.

The Ken Schaffer Group is one of the world's major suppliers of top-of-the-line special effects equipment. Particularly, **Eventide Digital Delay** (1745M), the **Eventide Harmonizer™**, **Instant Flanger™** and **Amazing Omnipressor™**. We've supplied hundreds of major bands and studios.

Normally kept on stock for immediate delivery. We also offer a number of exclusive custom modifications which make the entire Eventide line even more versatile in both live and studio application.

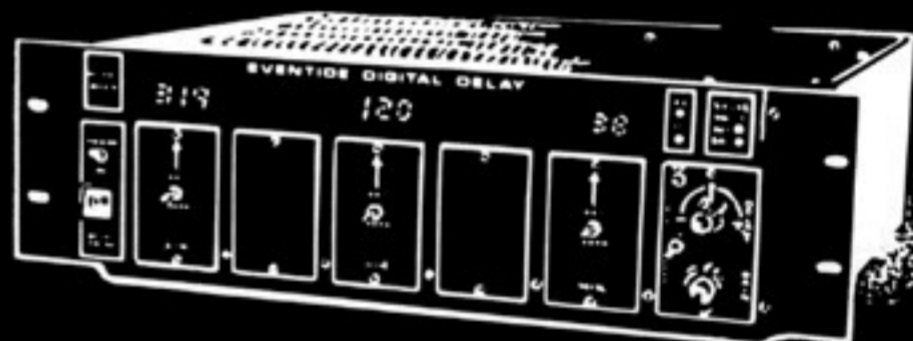

Eventide is **the** standard delay equipment for nearly every major studio on six continents. It's the secret behind dozens of special effects you hear in live concert with nearly **every** major band. It's far and away the best.

(List Prices: Model 1745M \$4100; Pitch Change Module \$850; Additional Plug-in independent delay outputs \$550; Harmonizer, all options, \$1865; Polyphonic Harmonizer Keyboard \$600; Instant Flanger \$615; Omnipressor \$600).

Complete Operating Manuals @ \$5 each.

Time and Space.



THE KEN SCHAFFER GROUP, INC.

10 East 49th Street • New York, New York 10017 • (212) 371-2335

Editor

Douglas Lynner

Art Director

Chris August

Managing Editor

Melodie Bryant

Photography

Bill Matthias

Contributing Writers

Craig Anderton, Richard Bugg,

Andy Capraro, Alex Cima,

Bob Davis, Richard Diemer,

Colin Gardner, Frank Gavin,

Peter Hillen, Magic Moe, Scott

Morgan, Ken Perrin, Virginia

Quesada, Danny Sofer,

Eric Valinsky

Correspondents

Boston: Kenneth Perrin

Northern California: Phil Loarie

Chicago: John Parris Frantz

Connecticut: Chuck Scribner

Louisiana: Tony Prestigiaco

Maryland: Paul Medlock

Minneapolis: John Borowicz

New York: Carter Thomas

Oklahoma: Richard Bugg

San Diego: Steve Roach

Texas: Barton McLean

Western Canada: Jerry Ozipko

Columbia: Luis Guillermo Restrepo R.

England: K.S. Dulay

West Germany: Christian

Charles Kneisel

Japan: Eiji Ueda

Sweden: Gregory Allen Fitzpatrick

Contributing Photographers

Marion Gray, Bernd Kappelmeyer

Studio, Bob Landau, Jean-François

Podevin, Virginia Quesada

Production

Melodie Bryant, Lemon De George,

Colin Gardner, Bill Matthias,

George Sanders

Cover Photograph

Chris August

Synapse is published bi-monthly at 2829 Hyans Street, Los Angeles, CA 90026 by Synapse Publishing Co. The entire contents of Synapse are copyright © 1978 Synapse Publishing Co., all rights reserved, and may not be reproduced in any manner, either in whole or in part, without the written permission of the publishers. Application to mail at second-class postage rates is pending at Los Angeles. Manuscripts, photographs & artwork: All contributions are welcome, however, we cannot be responsible for the return of unsolicited materials. Enclose a self-addressed stamped envelope with any contributions and send to Synapse, 2829 Hyans Street, Los Angeles, CA 90026. Advertising Contact Doug Lynner or Chris August at (213) 382-7933 for our current rate and deadline schedule. Distributors & Dealers: Contact Chris August or Doug Lynner at (213) 383-7933 for discount information and publishing schedule. Subscriptions: Within the US the annual six-issue rate is \$8.00. A domestic first class mail subscription is available for \$14.00 yearly. The one year foreign subscription rate (by surface mail) is \$10.00. A special foreign air mail subscription is now available for \$20.00 annually. Single copy newsstand price is \$1.50 in the US and Canada; Australia, Europe, and Japan \$2.00. Back Issues: We are presently sold out of most issues. Please send a postcard for our files naming the issues you lack and they will be reprinted when demand is sufficient. Change of address: Notify Synapse/Subscriptions at 2829 Hyans Street, Los Angeles, California 90026. We are not responsible for issues lost when we have not received an address change notice. Please send both the old and new addresses, and if possible, the mailing label from your copy of Synapse.

Edgar Froese

Tangerine Dream regroups

—Frank Gavin—18



Michael Hoenig

*Warner Brother's artist:
Not singing the blues*

—Doug Lynner—22

Jean-Claude Risset

IRCAM from the inside out

—Doug Lynner & Virginia Quesada—27

Home Recording Part Two, Production Techniques

—Bring out the best in yourself—Craig Anderton—33

Patch Notation

—A business approach—Richard Bugg—37

2:5 Notes from the publishers 4

Letters Reader feedback 4

What's Happening Around the world..... 7

Profiles Stefan Weisser, Boston School of
Electronic Music, The Gizmo 7, 10, 46

Survival Notes Marketing your music 8

Performance American Stockhausen Festival,
Currents/Theater Vanguard Concert 12

Book Review Pieces Three by Michael Byron 14

Discola Bowie, Tomita, Eno, Tangerine Dream,
Robert Ceely, & New Releases 15

Advertisers Index 39

Computers Digital Delay Lines 41

Synthesis Ambience, Part Two 43

Tech Notes Pitch Drift in Keyboard Synthesizers 43

Listings Addresses of interest 44

Classifieds Buy, sell, trade and have made..... 45

LETTERS

Recording Artists are Addicts

Because you made us addicted by sending free issues we would now like to subscribe to your magazine. Please send us all numbers of this year except the first two.

The Boys From Kraftwerk
Dusseldorf, West Germany

Eno

I would like to find out what type (brand, model, make) synthesizer Eno uses.

David W. Hames Jr.
New Britain, Conn.

On his new release, *Before and after Science* (Polydor 2302071), Eno uses the AKS Synthesizer by EMS, a Yamaha CS80, and an unidentified Moog. **Ed.**

For Us

After re-reading Pat Gleeson's review/lament in the Nov./Dec. issue for the tenth time, I can do nothing more than agree. My musical tastes run from Bach chorals to K.C. and the Sunshine Band, but I prefer electronic music when I can find it. I used to content myself with Pink Floyd, then found that Robert Fripp of King Crimson did a better job of satisfying my desires. It was through my passion for Robert Fripp's guitar playing that I became acquainted with the music of Brian Eno. Now I haunt the record racks of my local music stores searching endlessly, and for the most part without success, for more electronic music. It does seem that the industry is geared for the millions, and not for those of us who believe that electronics does contain the way into the future.

I'm just starting out in electronic music. I purchased an ARP Odyssey, and am devoting as much time as possible learning how to operate it. I want to say that I am quite pleased to have discovered your magazine, because it helps me realize that I'm not the only person in the world who is not pleased with what is available today, and that there are others who are interested in electronics. Also, I would like to leave my address, in case others in my area write to you looking for people who want to explore the possibilities of synthesizer music. I am an amateur, but have enthusiasm, and the desire to explore.

Chuck Larrieu
P.O. Box 294
Corte Madera, Cal. 94925

Reader Concensus

Enclosed is \$2.00 for a copy of Vol.2, No.3. I will buy copies of all the issues you reprint. (Please do so. I'm sure you will sell at least ten complete sets to my students also.)

I would like to see more technical information in Synapse, though I think the magazine is excellent, and hope it is a success. I would like to see a reader/user survey of equipment, to see the consensus of reliability, service time, stability, etc., of whatever they have used.

David R. McClanahan
Cincinnati, Ohio

An interesting idea that Synapse is open to supporting. Readers, if you have information of this sort that you would like to share, please forward it to the editor. Remember to include your name, address, and phone number. **Ed.**

If You Like To Be On Top

I would like to say I am very pleased with Synapse. It is extremely informative and helpful to me as a performer, composer, and recording artist. As a producer it is also a must. Synapse keeps on top of things.

Thomas Alletto
Ojai, Cal.

Favorite Record Stores

Your magazine is the best in the West and so popular I can pick it up at my favorite record stores, so I have a feast for the eyes and

ears at the same time. Never stop with those great articles.

Charles R. Forsythe
Fountain Valley, Cal.

Thanks Charles. And readers, if Synapse isn't carried by your favorite store, tell them about Synapse and give them our address. **Ed.**

There is Nothing Boring About Ohio

I have been interested in synthesizers for about five years, but it is only recently that I have begun to acquire a lot of equipment. I have been motivated to build an eight channel electronic studio after being contacted by an organization in Cincinnati called Image Distribution. A local FM station sponsored a project for local musicians to submit original works for an album project. I recorded three numbers on a four channel Dokorder, and was fortunate enough to have one of my works selected for the album. Image Distribution heard my number, and contacted me to discuss the possibilities of co-ordinating my synthesized instrumental music with video artists seeking compatible music for their creations.

So, inspired by Image Distribution's national and foreign contacts, I have acquired three ARP synthe-

sizers, an ARP sequencer, Fender Rhodes, ELKA String Machine, Hammond B-3, Otari 5050-8D, Dokorder four channel recorder, Southwest Tech. amps and pre-amps, Delta-Graph equalizers, DBX 8 channel noise reduction unit, a few PAIA modules, a 12 channel mixing board, four monitor speakers, and a few other odds and ends.

Right now I have an MXR digital delay and a DBX RM-160 compressor on order, and I'm looking into some Serge and/or Aries modular synthesizer systems to build up a custom system. I talked to some Aries people the other day, and they are going to be coming out with some digital equipment that really sounds great. I would also really like to start getting into some computer-controlled synthesizer systems, which leads me to a request for you to keep throwing some good computer/synthesizer application articles at us.

Ohio is not a synthesizer garden spot though. There are few music stores that stock synthesizer equipment. It is also hard to find outlets that can demonstrate good studio equipment. I envy East and West Coast residents who are located in the equipment/educational seminar/information exchange areas. So, being in Ohio, I can really appreciate publications like Synapse magazine. I enjoy all the articles, and you can throw as much technical information applications at me as you can handle. I would also enjoy articles on new I.C.'s and their applications to synthesis or control.

Ron Crosby
Carlisle, Ohio

Thanks for the inventory. **Ed.**

Education

How about some articles on what's available at various educational institutions for someone wishing to pursue electronic music on an academic level?

Chris M. Dawson
Amherst, Mass.

An article of interest to you will appear in the next Synapse. **Ed.**

Contacts

Thanks for putting my letter in the July/August issue of Synapse. It has brought me correspondents clear across the country and, more recently, some visitors said they saw the letter.

While not directly involved in composing on a synthesizer, it will happen sooner or later. Especially considering that I built my first electronic instrument, a keyboard oboe, 41 years ago and it still works as well as ever.

Ivor Darreg
Glendale, Cal.

Synapse

2:5

In the interest of better serving our readers, Synapse has changed its subscription recording and mailing system. In doing so, our records were transcribed, one by one, so the possibility for error exists. Check your mailing label to be sure we got everything right. If there is a mistake, or if you think you have missed an issue, write to the subscription department and explain the problem. It will be taken care of.

Since its inception, Synapse has grown from a paid circulation of 100, to our present 7000. On one level this reflects the success of our venture, but on another level it reflects the interest of musicians to apply contemporary technology to their music. It is this interest that is central to Synapse.

Music is manifested by styles. It is easy to make a point of these styles (if that indeed is the point), but perhaps it is more fruitful to look at it as a totality—that is, how contemporary technology is affecting music. So while others are discussing the relative value of one style as opposed to another, Synapse will be discussing all of the styles and their relationship to 1978. This approach will never edify stylistic bias, and we think that is just. The purpose of Synapse is not to censure the world and give you our version, but to deliver it raw for your own processing. Karlhienz Stockhausen and Isao Tomita appearing in the same issue is understandable given this format, and judging from the response, Synapse readers feel represented by both the old and the new, the east and the west, the right and the left, and the right and the wrong. It all exists as experience, and to judge would be pretentious, if not short sighted. Synapse does not wish to de-emphasize personal taste, but would like to acknowledge that we all (for the moment anyway) live on the same planet and use the same tools based on the same history. Only factions stand to gain by the factionalization of musical expression, but we all stand to gain from open, non-political communication.

—Doug Lynner & Chris August

That's what Kerry Livgren of Kansas asked as he sat behind the keyboard of the new Korg polyphonic synthesizer. It didn't take long to transform Kerry from questioner to convert. Because after a few minutes of playing he found a lot more than the portamento.

Kerry discovered features he had never seen in any synthesizer. Like a totally polyphonic keyboard with each key triggering its own dynamic filter, envelope generator, and VCA. Polyphonic voltage-controlled sample and hold. Six different simultaneous modulations. A programmable wheel, joy stick and transient controllers. And a patch panel that performs musical miracles.

In fact, Kerry liked Korg so much he used the synthesizer on the Kansas album Point of Know Return. Here's what he had to say after the recording session. Take it Kerry.

"A New Ax Every Ten Seconds."

"The Korg Professional Laboratory Systems synthesizer is in a class by itself. It sounds totally different from any synthesizer I've ever played. It's like having a new ax every ten seconds."

There are 10 Korg models of exceptional value, ranging from the Professional Laboratory Systems group to the new Micro Preset, which puts 315 instant voice combinations at your fingertips.

Whether you're looking for a preset, a polyphonic, or a dynamic portamento, you'll find a Korg synthesizer that meets your exacting requirements.



"Where's the portamento?"



KORG

Another superstar of sound from Unicord
75 Frost Street, Westbury, N.Y. 11590
Sold in Canada by Erikson Music Co., Montreal

Sequential Circuits Introduces:

the prophet

The Industry's First Completely Programmable Polyphonic Synthesizer

When Sequential Circuits introduces a synthesizer, you can be sure it utilizes the most advanced technology. state-of-the-art technology that makes readily available the most asked for features musicians have been demanding for years.



the prophet

comes in 5 and 10 voice versions, 2 oscillators per voice. Individual oscillator tuning? We think you have better things to do with your time. The Prophet's powerful internal computer automatically handles all tuning. The same computer lets you create and record 40 different patches and recall any at the simple touch of a button.

More? A 5-octave keyboard. Pitch and Modulation wheels. Small size (37" x 16" x 4½"), ideal for stacking with other keyboards. Memory power back up with a 10 year life.

The Prophet provides unparalleled ease of use while retaining the sophistication required by the most demanding synthesists.

Prove it to yourself. Ask your local dealer or write us for further information.

SEQUENTIAL CIRCUITS INC

1172G Aster Avenue, Sunnyvale, Calif. 94086 (408) 296-3116

what's happening

... Since last issue's What's Happening mention of the **Bay Area Synthesis Studio** (BASS), the name has been changed to the **Electronic Music Users Studio** (eMus). "eMus" will continue to offer Bay Area Synthesists an alternative to the high cost of commercial studios and the limitations of academic studios

... From March 29th (San Diego) through May 8th (New York), **David Bowie** will tour the U.S., and the synthesist in the band will be **Roger Powell**. Bowie's last two albums, "Low" and "Heroes", have featured collaborations with Brian Eno and Robert Fripp, and represent an interesting departure from both the pop and electronic music worlds

... **Computone, Inc.**, has released the **Lyricon Wind Synthesizer Driver**. The entire package retails at \$1495.00 and includes the controller, console, and case. The controller resembles a soprano saxophone both in appearance and fingering. The controller's outputs



The Lyricon Wind Synthesizer.

are fed to the console, making them compatible with the synthesizer you are driving. The outputs from the controller monitor lip motion, wind pressure, and finger position. The unit is available from: Computone, Inc., P.O. Box 433, Norwell, Mass. 02061.....

... The **New England Conservatory of Music** Summer School will sponsor two electronic music workshops. The Electronic Music Workshop, with well-known Boston area synthesist **Robert Ceely**, to be held June 26—June 30, will offer lecture demonstrations and hands-on experience using several types of synthesizers. July 10—July 14 **Larry Allen** will offer Electronic Music in the Classroom, a workshop for educators, which will explore teaching electronic music. For more information, contact: Robert L. Annis, New England Conservatory of Music, 290 Huntington Ave., Boston, Mass. 02115 (617) 262-1120.....

... The **Hawaii Electronic**

PROFILE:

Stefan Weisser/Percussionist



PHOTO BY MARION GRAY

Stefan Weisser would describe his performance medium/music as an "analog acoustic assemblage." I would call it a sound-producing phenomenon. There is nothing electric about it except the sound quality and the effect of the performance on a viewer.

I write "viewer" because it is this function that Weisser feels is inadequately dealt with by electronic instruments. The sound is right, but the physical energy does not mesh up. To some, it is disconcerting that the twist of a dial can produce a sonic explosion of high volume without the "twist" communicating that same intensity. Weisser's solution is percussion of the found and home-made variety.

Weisser describes his instruments as, "... stainless steel, titanium, military aluminum—HI TEMP/PRESSURE in their production creating a multiplicity of complex signals not available in LO TEMP/PRESSURE metals. Same holding true for plastics. Wands, threaded rods, custom mallets developed random/rapidly sequential 'triggering' of instruments."

The end effect is a vibrant and energetic performance that rises to incredible densities; swirls of timbres interact to create the richest harmonic spectrum ever experienced by this writer. When the sound finally subsides, the viewer is impressed by the pure physical energy exhibited, and may feel himself to be the recipient of a surrogate "workout" in the gym of musical expression.

Stefan Weisser, known professionally as "Yoel," performs widely in the Bay Area and hopes to extend his concertizing to other areas. Over the next four months, he will present a series of concerts named Full Moons at Fort Mason Center in San Francisco. The dates are April 22, May 22, July 19, and August 18. For more information and bookings, call: (415) 444-6431, or write: 1465 MacArthur, San Francisco, CA 94602.

—Douglas Lynner

Music Group is once again active in instruction and consultation in the field of electronic music. Contact them at: Box H-8, Room 213, 2445 Campus Rd., Honolulu, Hawaii 96822 (808) 955-2839.....

... **John Cage** and **David Tudor** will perform a benefit concert for **PASS**, New York's Public Access Synthesizer Studio. The performance will be held at the Loeb Student Center on the campus of New York University, April 10th, at 8:00 PM. Tickets are \$5.00, and \$3.00 for students. In March of 1977, PASS opened its doors to provide composers, performers, and the curious, access to synthesizers and recording equipment (only \$3.00 per hour), teachers, a tape library, a circuit file, concerts, and presentations. Since its opening, PASS has received support from many magazines, newspapers, and individuals across the country; and the support is well deserved. PASS has addressed a problem based in our culture's

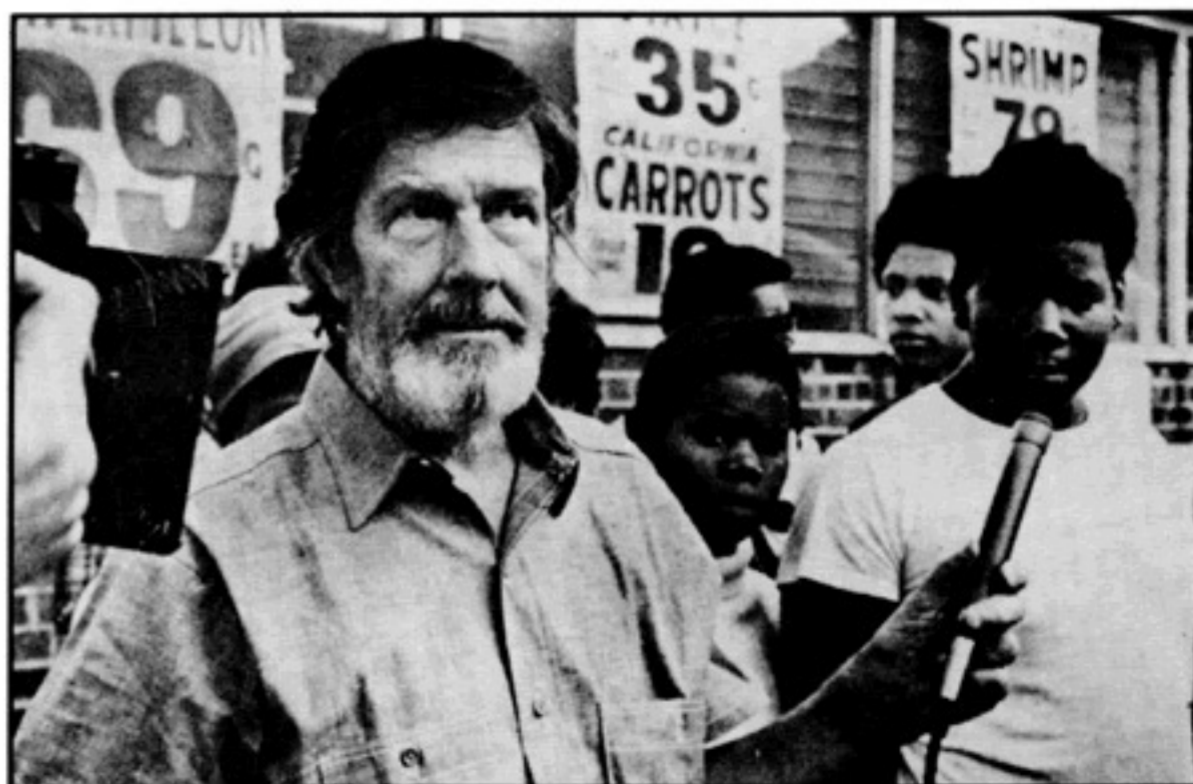

John Cage in Nam June Paik's "Suite 212"

profit-oriented approach to art. Supply does not always meet demand because the demand is not always monetary. In music, the demand is culturally based—many even believe music is a necessity.

Even though most political and business "leaders" would state that music is highly important to a progressive and engaged society, the ability to make music is still largely

turn to page 9

Survival Notes

MARKETING YOUR MUSIC

In my previous article "Space Rockers Unite", I proposed that there is a growing market for electronic progressive music, which seems to be expanding as rapidly as the general public becomes musically and culturally educated. Movies like Star Wars and Close Encounters have almost made *Synthesizer* a household word. From the overwhelming response I received to "Space Rockers Unite" it is obvious to me that many of us are in the same boat: producing uncommercial music for art's sake, wanting-needng new and better equipment but alas low on funds. So, here are some views on low budget marketing and a few specific schemes to make money.

To begin with I feel that the decision to market your music is a very important step and should take serious thought. If a project, any project, is to succeed it must be backed with complete faith and intense motivation. In the record industry this formula is translated = Money but I am approaching this subject from the starving artist level. First you must question yourself: Is your music so good that you should market it? Do people enjoy it? Do your friends and/or family believe in your music? This is especially important because underground promo begins here. If the people around you get off on your music they will tell others who in turn will tell others; a lot of footwork and salesmanship are necessary, and this is where loyal friends and believers are invaluable! Now let's consider your music as a product; this is the reality of marketing. A master tape whether recorded in a 24 track studio or at home on your 3340 *must be clean*, don't try to push a sloppy product or you are defeated from the beginning. For example: "Good Morning" by Daevid Allen was recorded on a 3340 and is exceptionally clean. Enough said as I believe most of you who read Synapse are into state-of-

art sound.

So once you have a good clean master tape what can it do for you? Here are five different suggestions for marketing your original music and I'm convinced that if you can manage to break even on some of these musical ventures, then you have succeeded. I spoke with Bob Fripp during the King Crimson "Larks' Tongue" tour and he said that it was a thrill to break even because all previous King Crimson tours had lost money!

1 If you are on a super low budget,

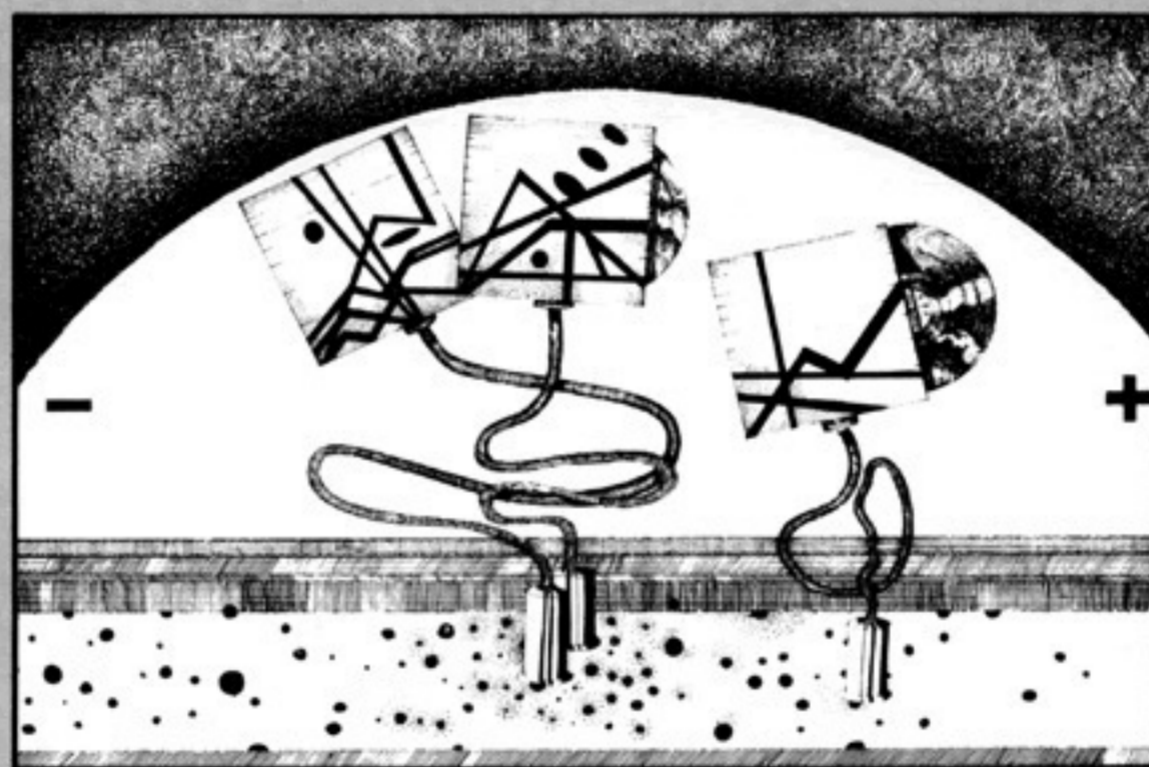

run off cassette copies from your master and sell them mail order in the back pages of Sci Fi magazines. Sci Fi freaks are open minded towards "spacy sounds". Offer them creativity, Sci Fi music to read, write or paint by. There are many Sci Fi and other cult magazines to choose from, the main idea is to advertise where you feel potential customers may be found. This applies to other magazines and journals depending on your style of music and budget.

2 I discovered that excerpts from some of my works provided great background music for radio commercials, dramas, station I.D., etc. This is a difficult area to break into

but well worth a try. Most accessible are UHF T.V. stations and FM radio stations that are on the fringes of the big city. Synthesized music is becoming commonplace on T.V. and radio.

3 If you have two or three thousand dollars available, press a limited edition L.P. to be sold mail order as above, at local independent record shops, (if they don't buy them, put them on consignment), at Sci Fi conventions, swap meets, gigs, local music stores and anywhere and everywhere you can sell

them. If you press a thousand for example, you could give away 200 for promotion and every possible business connection, then sell the remaining 800 for \$5 each and you might break even! One unique idea that I heard of is a collaboration between musician and artist where the L.P. cover and insert are high quality prints which illustrate the music. These can be signed, numbered, and sold as collectors' items but at a higher price if you want to break even. Four colour printing is très cher.

4 Locate serious amateur film makers such as cinematography students and approach them about

providing soundtrack music. Here you will find limited budgets and may be offered to work on spec. A speculative project is when you agree to receive money only if and when the whole project is sold and makes profit. My experience in this area has not made me rich, however valuable future contacts will be made working with your contemporaries, and if your music is incredibly good, word will travel.

5 If you are presently geared to performing or have a group, promoting your own concerts can work to your advantage. Places for presenting concerts are not easy to find nor inexpensive to rent. Private clubs, cultural centers, school theatres and town halls may be secured after exhaustive searching. Here are some helpful tips: always approach these places with a very professional attitude—you are performing *art* not a rock concert—your music is sophisticated not boogie—you attract a well educated crowd not teeny boppers. I have found this line of reasoning can be convincing, even with a name like French Lick! If you are asked about the instruments involved, talk about the most complicated electronic gear. Never mention guitars and always refer to drums as percussion. Lights, special effects, programs, all of these things can, if done with a professional attitude, tremendously upgrade your production. Most important, you are lucky to find a place to perform, so don't give bad vibes—pay in advance if possible, tip the custodians, leave the place clean and send a thank you note later in appreciation. You will then find it much easier to secure the hall next time around. Plan for the future, you have now established a reference which will help you get into better places. To continue with the marketing aspect, your own records, posters, T-shirts, etc. could be sold at the gig.

Reach for the stars, bonne chance.

— Magic Moe

What's Happening

from page 7

proportional to one's income. No treatise is needed to illustrate the disadvantages of this approach. PASS has opened its doors to diversity and creative need, and we all benefit whether we live in New York or Los Angeles. If you have the opportunity to visit PASS and haven't, you are missing out. PASS is a hub for energy and information that we should all be part of. Contact: PASS 135 West Broadway, New York, New York 10013 (212) 964-9891.....

... Japan's **Far East Family Band** has moved to the U.S. Now settling in L.A., the band is known as one of Japan's most popular progressive groups, drawing crowds of 100,000 to outdoor festivals at Mount Fuji. The band's first US disc

music. The first three concerts are slated for April 16, April 30, and May 7, and will present various electronic and instrumental pieces. The first concert will be music by women composers, featuring **Pauline Oliveros**. The last concert (no date set) will be a performance of **Terry Riley's "In C"** with the composer present. All concerts will start at 8:00 at the Larchmont Center, 230 1/2 North Larchmont Blvd., L.A. Tickets are \$3.50, \$2.50 for students and senior citizens. For more information call (213) 464-1276.....

... **Rocktronics**, 22 Wendell St., Cambridge, Mass 02138, has released the **"Super Six"** state lighting controller. The unit features six channels that are sequenceable in several configurations: automatic dimming and chasing, amplitude following circuitry that controls brightness from a sonic input, and



PHOTO BY BOB LANDAU

The Far East Family Band moves west.

Tenkujin has been creating quite a stir among import record connoisseurs. Their US concert debut (sponsored by their label **All Ears Records**) took place to receptive audiences over Easter weekend at the **Troubadour** in Los Angeles. . .

... **Audio/Pulse, Inc.**, has released the **Model One Digital Time-Delay System**, list price, \$629.00. The Model One is designed to synthesize the ambience of a live musical performance, i.e. the room. A "secondary" stereo amplifier and speakers are used to distribute the delayed, reverberant output. The unit creates multiple delays that are cross-coupled between channels, and recirculated to enhance reverberance. Audio/Pulse, Inc., Bedford Research Park, Crosby Drive, Bedford, Mass. 01730.....

... The **Independent Composers' Association (ICA)**, a group of eleven young Southern California composers, will present **"Second Second Story Series"**, four concerts of "new"

dim/chase operation, allowing three channels to highlight performers, while the other three channels can "chase" the music's amplitude. The Super Six lists for \$400.00.....

... **Eventide Clockworks, Inc.** has released a microprocessor-



Eventide adds a micro-processor controlled remote control card to their 1745M Digital Delay Line.

controlled remote control card that plugs into an unused connector in turn to next page

HERE'S ONE YOU WON'T HEAR ON TOP 40.



It's an album that contains no hit singles. It doesn't have any of the things you thought a hit record was supposed to have.

It does have what the best records of the future will have: an effect on the listener that goes beyond music. It's so hypnotic, so relaxing that listeners are sure to leave their bodies for the 45 minutes it's on their turntables. No kidding!

Composer Michael Hoenig has been in the vanguard or Europe's electronic music scene since its earliest days in Berlin.

The music on **Departure From the Northern Wasteland** was made by this one man, on one instrument, for one stated purpose:

"I want it to provoke a feeling, a mood people can react to. It's music that is finished in the mind of each listener."

Michael Hoenig.
Departure From the Northern Wasteland.
Produced by Michael Hoenig.
On Warner Bros. records and tapes.



***** Hear Michael Hoenig For Almost Nothing. *****

We're so sure this record will become one of the most talked-about records of the year, that we'll send you a third of it for only 25 cents! The Michael Hoenig EP: Order Today!

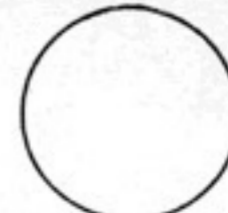

WARNER BROS. RECORDS
P.O. BOX 6868
BURBANK, CAL. 91510

Dear Sirs:
I just got home from school/work and I'm shot. I need Michael Hoenig's **Departure From the Northern Wasteland**. Here's my quarter(s).

NAME _____ ADDRESS _____

CITY _____ STATE _____ ZIP _____

P.S. Your Michael Hoenig EP will arrive in 6 weeks. Please note: You can leave your hat on, but turn the lights down low and get ready to RELAX. Offer good only in U.S.

SYN

Profile:

The Boston School of Electronic Music

An Inside Perspective/by Kenneth Perrin

Since 1972, when Jim Michmerhuizen started the Boston School of Electronic Music, it has undergone a continuous change. In the beginning it was, as he wrote in an early catalog, an outpost on the edge of a wilderness. B.S.E.M. was a sonic trading post where musicians provisioned themselves with some knowledge and insights into the synthesizer so that they could better survive on their own in the largely un-mapped area of electronic music synthesis. One basic tenet which we taught at B.S.E.M. from the beginning was that the information and techniques needed to use a synthesizer intelligently and creatively don't change with the style of music performed. A modulation timbre is created the same way whether it's used as a funky bass line or as an element in a tone row. Of course that may seem obvious to everyone now, but this was six years ago when synthesizers seemed almost magical creations of technology which could produce "any sound imaginable" and seemed about to put honest musicians out of work and replace them with technical wizards who understood this new machine.

With the proliferation and accessibility of synthesizers, B.S.E.M. assumed a different role. What was un-explored territory a few years ago has been mostly mapped now, but inaccurately! For example, in a recent interview a pop "star" said, "Anything you can do with an Arp 2600, you can do with a Mini-moog." Advertising agents have come to the studio and asked for a recording of "the sound of the synthesizer." One manufacturer has labeled the envelope generator on his instrument a "trajectory control." With such nonsense abounding, it is a small wonder that piano players who also happen to own synthesizers, win awards as "the best synthesist of the year".

In reaction to all of these popular misconceptions about synthesizers,

one of our roles is a quixotic one of maintaining educational facilities and programs in which students can learn factual information about electronic music instruments and in which they are exposed to professional standards against which they can evaluate their own work.

Another way we see ourselves is as a collective studio. All staff members at B.S.E.M. have a thorough knowledge of the synthesizer and we are all either performers or composers. In our studios we have access to the hardware that enables us to do our own work. Additionally, we have created an environment in which not only can our students learn from us, but in which we can also learn from each other. It has become a cliché that electronic music is a combination of art and technology; but it's true. We continue, singly and collectively, to explore ways in which the two disciplines can be combined and our recent efforts have been in the direction of a hybrid studio. This studio incorporates a huge Aries system, a TDL micro-computer and an 8 channel analog recorder.

As we continue to increase our facilities and our collective knowledge, we also increase our course offerings. In the beginning we had only a series of one month courses in audio synthesis. Currently we offer 10 different courses in 2 semesters dealing not only with audio synthesis, but also with music theory, composition and analysis, electronics, and math. The more we grow the more obvious it becomes to us that anyone working in electronic music cannot afford to become a specialist. The study of synthesis itself requires a synthesis of many different disciplines and to be proficient in the field necessitates a broad understanding of many areas.

Next fall we will expand our basic program into 4 semesters of study encompassing 19 different courses.

Included in the second year are courses based on understanding and using the computer, not only as a synthesizer controller but also as a compositional tool. Also, we will offer courses in the physics of music and in psycho-acoustics as well as more advanced music courses.

Last September we moved from our cramped quarters in Boston's Back Bay to a small mansion in the suburbs. This move finally afforded us the physical space to implement our planned curriculum expansion. On January 3rd this building was heavily damaged by a fire. Friends and former students offered their help and with their assistance we were able to move all our equipment out quickly and nothing was seriously damaged. We moved into a new building on February 1st and were set up for our spring semester by February 6th. Although the fire was serious, it caused us no lasting damage and our expansion will continue as planned. Unfortunately some of our files and correspondence and all of our course catalogs were destroyed. Those who have requested information from us and have not received it, please contact us again; your letter was destroyed by the fire.

In addition to developing the new course material for next fall's semesters and writing the software for our hybrid studio, we are working on a number of other projects including an electronic music textbook, a synthesizer lab manual, and the **More Than a Patch Book** patch book. Also we are sponsoring, along with the Studio for Inter-related Media at the Mass. College of Art, a tape music concert in late April. This concert will offer an opportunity for composers across the country to present their pieces to a Boston audience. Anyone interested in receiving information on any of these projects, or general information about the school, please contact me at B.S.E.M. 28 Highgate St., Boston, Mass. 02134.

What's Happening

from page 9

their 1745M Digital Delay Line. The card uses the IEEE standard interface to allow computer control of delay setting, repeat and double modes of operation. The remote unit costs \$550.00. Eventide is also offering a pitch change module option for its 1745M Delay Line for \$850.00. Eventide Clockworks, Inc., 265 West 54th St., N.Y., N.Y. 10019.....

... The **Center for Contemporary Music, Mills College**, (415) 632-2700, has an active series of concerts of contemporary music with free admission. Call them to see what's on next.....

... **Electronic Music Laboratories, Inc.** P.O. Box H, Vernon, Conn. 06066, has released a line of 18 "**Circuit Modules**" cover-

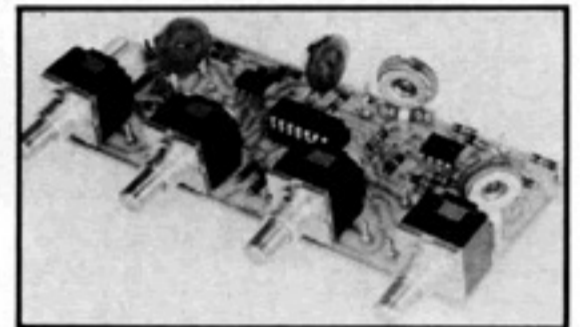

EML's Dual Voltage Controlled (DVCA-1). Circuits are open and can be user modified.

ing most basic synthesizer functions. The circuits are open, and can be modified by the user. The costs range from \$22.50 to \$225.00, and discounts are available for quantity orders. EML also sells the hardware and cases.....

... **Robert Landau**, whose photographs you enjoyed in last issue's Jan Hammer interview has attained considerable acclaim for his work recently. In addition to exhibits of his work at the New Media Gallery, Ventura College, Ventura, Calif., and the ARCO Center for the Visual Arts, Los Angeles, Landau was named "Photographer of the Month" in the Feb. 1978 issue of *Mode International*. He also has a two-page color spread on Los Angeles billboard art in the Feb./March issue of *Sportswear International*, published in France, and was recently awarded the Silver Medal in the black-and-white category of the Nikon Photography Contest for his photograph entitled "Levitation"...

... The **Kitchen Center for Video and Music, New York City**, presents an on-going series of concerts of interest to contemporary musicians and artists. Recent events have included a five day mini-festival, coordinated by **Alvin Lucier**. Titled "Music in Real and

Imagined Spaces," the series was devoted to works based on architectural acoustics, and will serve as a pilot project for future developments in the design of a visionary performance space for music. Works by **Nicolas Collins, Ron Kuivila, Paul De Marinis, Stuart Marshall, and Alvin Lucier** were included. For information call: (212) 925-3615. . . .

. . . In case you have not heard of the **Official Talent & Booking Directory**, here's a short description of its contents. Covered in this 800 page reference publication are: U.S. recording artists, personal managers, booking agents, record companies, ticket companies, manufacturers of musical instruments, recording equipment and disco equipment, colleges and television shows presenting musical talents. If you're interested, a hard-bound volume with your name engraved in gold on the cover is available for \$40.00. Contact Specialty Publications, 7033 Sunset Blvd., L.A., Cal. 90028. . . .

. . . Synapse had the pleasure of an in-office demonstration of the **E.G.C./Gentle Electric Synthesizer Guitar**. The system uses the **Gentle Electric Synthesizer Interface** and the **E.G.C.**



PHOTO BY BILL MATTHIAS

E.G.C. Hexaphonic Guitar and the Gentle Electric Pitch Follower / Synthesizer Interface.

Hexaphonic Guitar with a newly designed pick-up that requires no special placement and yet communicates to the interface all guitar techniques including string bending. Both monophonic and polyphonic systems are available on a custom basis, and rentals for recording purposes are available in Los Angeles only. E.G.C. is also available for consultation on instrument/synthesizer interfacing.

Contact: E.G.C./Ernest Perevoski, 417 Ocean Front Walk No. 3A, Venice, CA 90291, or E.G.C./Jacob Moskowitz 3006 Plyers Mills Rd., Kensington, MD 20795. The Pitch Follower/Synthesizer Interface is available from Gentle Electric 130 Oxford Way, Santa Cruz, CA 95060. . . .

. . . **Strider Systems, Inc.** has released a **Digital Envelope Generator (DEG)** designed for

the original equipment manufacturer market. The DEG is a micro-computer controlled, 37 input, single output audio mixer and keyboard scanner combined on an 8" x 10" printed circuit board. The microcomputer scans a multiplexed 37-note keyboard for keypress and release information to generate independent loudness transients for each of the 37 audio input channels. The factory presets 64 ADSR and LFO envelopes, and custom programming is available on a 10 day turnaround. In quantities of 100 units and up, the DEG sells for \$350.00, with small quantities for \$750.00 per board. For more information, write: Strider Systems P.O. Box 2934, Norman, OK 73070. . . .

. . . **Malatchi Electronic Systems** has recently unveiled their **Performer** series: six, twelve, eighteen, and twenty-four channel stereo mixers and mixer/pre-amplifiers. The systems feature variable input attenuators with an L.E.D. overload indicator, pan control (for stereo models), separate monitor mix, send and receive on each channel, four band graphic equalizer on each channel, internal reverb, L.E.D. output level indicator

turn to page 46

Synapse

What's the connection here?

Almost every synthesizer has a keyboard, but not every keyboard player is a synthesist.

Aries makes modular systems for the musician who considers the synthesizer to be his primary instrument. Modular design allows complete control over patching and normalled connections—thus each player can achieve a personalized repertoire of sounds.

Every Aries system is a custom design because every customer gets involved: choosing from our kits, modules and cabinets the kind of system he wants to use.

So if you play the synthesizer, and not just the keyboard, we think you've already made the connection. Call (617) 744-2400, or write:

Box 3065 Salem, MA. 01970

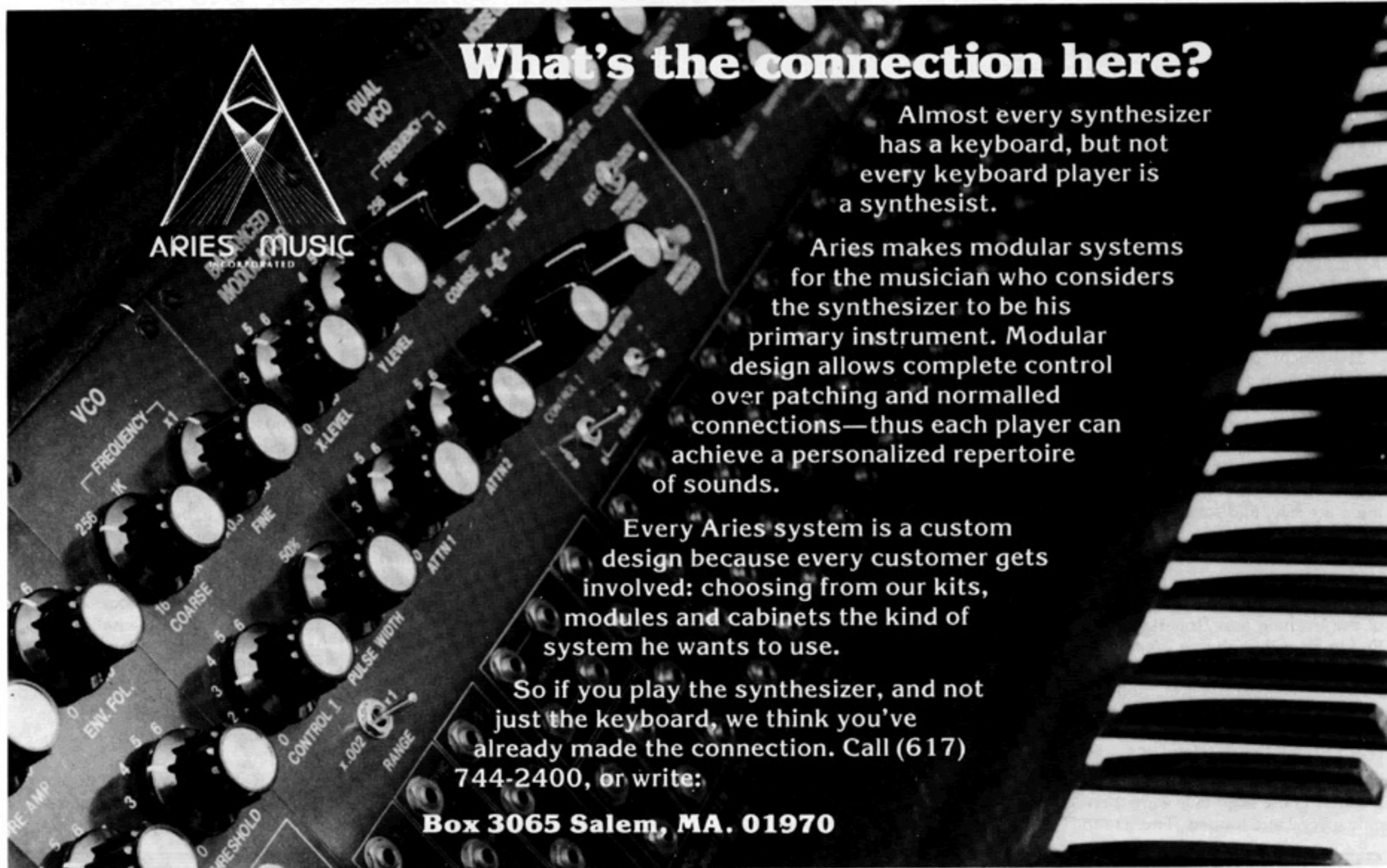

'Currents' Electronic Music Series

December 3, 1977
Theatre Vanguard,
Los Angeles

They should have taken the seats out of the Theatre Vanguard on Saturday, Dec. 3, 1977 and passed out pillows. Once again, Barry Schrader's Currents series has proved that electronic music need not be unfamiliar or unchallenging, but can be accessible and hypnotic—or do I mean dull?

Wave (for Kiyoko) by William Hawley and Carl Stone's *Lim* exhibited coherence of IDEA. And the one idea went on for a long, long time. Though *Waves* was composed of slowly pulsing tone clusters and *Lim* a slowly changing drone, for some reason the pieces seemed the same.

Onyx by John Adams was a bit more satisfying. The incessant, hypnotic chirping of recorded cicadas tied together a progression of drones, chords, and bells, marred only by electronic piano-like chords and clichéd wah-wahs.

Percussionists John Fitzgerald, Robert Fernandez, Duane Livingston and James Snodgrass performed Ingram Marshall's *Vibro-superball*, in which tambourines and high hats are caressed by superballs and phallus-shaped vibrators. Whether this obscenity was intended was unclear in this uncommanding and sloppy performance. Intersecting rhythmic patterns gave way to monotonous slow quarter notes. The percussion was amplified, which added to the annoyance, and the whole thing sounded like a dead march at the zoo.

Barry Schrader's *Lost Atlantis, Part II*, though pretentious, exhibited the most evidence of musical thought of the evening. At his best, Mr. Schrader displays an excellent, though limited synthesizer technique. At his worst, his musical ideas are silly, and sometimes downright Hollywood; for example, the initial synthesized trumpet fanfares.

By far, the most successful work of the evening was Roberta Friedman and Grahame Weinbrun's *Bertha's Children*. Each of four middle-aged siblings was filmed walking into a room, sitting down in a chair, buttoning his or her jacket, and looking at his or her watch, while verbally describing the actions. These segments were then cut, spliced and looped. The screen

was split into quarter size frames, and one to four frames were shown simultaneously—an interesting idea to begin with, enhanced by the filmmaker's regard for enticing structural development.

The soundtrack consisted mainly of tape loops and cuts of the characters' verbal reports. The electronic sounds, conceptually effective, were limited to a subliminal hum as well as TV ping-pong beeps which accompanied the appearance and disappearance of each frame.

—Eric Valinsky

American Stockhausen Festival

January 13-21, 1978
Houston, Texas

It was indeed a rare occasion, nine days of Karlheinz Stockhausen and his music. This American Stockhausen Festival would feature the premiere of Stockhausen's recent work *Sirius* as well as a lecture and series of chamber concerts. *Sirius* was scheduled for weekend performances and the chamber concerts were to be on the intervening weeknights.

Sirius is a composition involving continuous electronic music in the form of a prepared tape, basso profundo, soprano, trumpet, and bass clarinet. It was commissioned by the Federal Republic of Germany on the occasion of the American bicentennial. It is dedicated to "the American Pioneers on Earth and in Space". The performers are: Boris Carmeli-basso; Annette Meriweather-soprano; Markus Stockhausen-trumpet; Suzanne Stephens-bass clarinet; and Karlheinz Stockhausen-sound projection. Volker Müller and Günther Engels provided technical assistance. The piece deals with seasonal elements of the zodiac in the form of a message from the Dog Star to "the children of America", and could safely be classified as a theatrical work. The four soloists represent the seasonal elements: Basso—the North, the Man, the Seed, the Winter, the Night; Trumpet—the East, the Youth, the Bud, the Spring, the Morning; Soprano—the South, the Women, the Blossom, the Summer, the Midday; Bass Clarinet—the West, the Friend, Beloved, the Fruit, the Autumn, the Evening. The piece is structured in three phases: the Presentation, the Wheel, and the Annunciation.

The Atrium of the Bayou Building on the University of Houston at Clear Lake City is a very open space

—three stories leading up to the sky. Chairs were arranged in an inward circle—concentric circles with aisles dividing them into quadrants. An eight channel location system arranged overhead and platforms for the soloists define the circumference of the performing space. Stockhausen's mixing console with its strange connectors and unlabeled faders lies in the center like some electrocybernetic altar. Everyone faces this point.

Sirius begins in absolute darkness, after a brief silence. Stockhausen, seated at the console, fades up the tape and an electronic static fills the room—cloud cover. First, a very high tone, spinning fast, descends—then another, descending into the performance space—four of them in all, like celestial visitors. Loud chiming sounds cue the entrances of the soloists; first North, the Winter, dressed in a fashionable spacesuit of sorts complete with colour co-ordinated earphones. North introduces both himself and East, the Youth, the Morning, wearing a red and orange jester's costume complete with earphones and long pointy-toed shoes. South, the Mother, is next, dressed in celestial blue and soft helmet and earphones, and finally Golden West, the Friend, The Autumn, in golden earphones and golden soft helmet. The Presentation consists mainly of the soloists introducing themselves as the seasons, explaining that they are messengers from Sirius bringing a musical message to the "children of America". The Wheel begins after the players move from their platforms to come "play in the middle", which ends up in a humorous chat between trumpet and bass clarinet. The Wheel consists of the players clocking through the melodies of the zodiac. This represents the enormously dense section of the work. Melodic fragments grow and come into focus, and then gradually die out, while death and birth and songed seasons mesh in the night—continual extrapolation. Stockhausen silently operates the mixing console; the eyes close. The Sequences of the seasons are marked by electronic music interludes which represent elements of ice, fire, and wind etc. All is well despite sudden outbursts by the soprano that this is her season and the others should go away. After about an hour of these combinations of melodies and solos, the North announces the stopping of the Wheel, thus beginning the Annunciation. The Four Seasons thank the public for their "open ears and open hearts" and click off into darkness with the cued chiming sounds. Soon the electronic static

returns, a low sound slowly circles the room, gathering momentum, then suddenly spinning up, up, and away. The four entities complete their exponential ascent—back to Sirius.

After hearing the piece one soon realizes the need for more hearings—it is incredibly dense for only one. According to Markus, *Sirius* will be recorded in 1978 for Deutsche Grammophon.

Monday night's performance at the University of Houston's Dudley Recital Hall included *Telemusic* and a piece for clarinet/dancer, *Harlequin*. This was a 40 minute exercise in stamina for Suzy Stephens, as she played and danced the piece. Tuesday evening had scheduled three pieces: *Amours*, a piece in four parts for clarinet; *Poles For Two*, one of the shortwave pieces, for trumpet and clarinet; and *In Friendship* transcribed for flute. There were no program notes so Stockhausen gave them orally. On Wednesday there was a most interesting talk on *Telemusic*. After speaking awhile on elements of style, Stockhausen played sections of *Telemusic* stopping for comments by the public. He also played sections of the 28 original sound sources, explained the technical processes and outlined the "gagaku circuit", the basic patch for the piece. It was a most interesting 2 1/2 hours. Thursday evening's concert had four compositions: *Spiral*, another of the shortwave pieces, this time for one player, Markus on trumpet; *Song Of The Youth*; *Zodiac* for soprano and piano accompaniment; and *The Little Harlequin*, again for clarinet/dancer but a completely different composition. *Zodiac* is comprised of twelve song cycles and the same melodies are used in *Sirius*. The four channel playback system displayed excellent sound due to the very effective speaker placement by George Cisneros of Houston. Stockhausen operated the controls during the performances of the electronic music.

I was able to stay in Houston for the Friday performance of *Sirius* and found it to be somewhat low keyed in relation to that of Sunday. I am sure this was due to Ms. Stephens being attacked by an aggressive door which proceeded to lunch down on her toe nail, causing great pain. Markus did very well conducting sections and cueing the soloists, while earphones were used for monitoring the tape. All of the above works are written—no improvising.

I had always wondered what an authentic Stockhausen concert

turn to page 14

TRADE IN YOUR MELLOTRON

Old Mellotrons are needed for factory rebuilding. To fill the demand, we are offering a liberal trade-in allowance on your old model towards the purchase of a new Mellotron 400 SM or Mellotron Mark V. Or, if you prefer, have your old Mellotron factory converted to new 400 SM specifications. Converted Mellotrons incorporate all of the improvements found on new 400 SM models and are covered by a new warranty. Find out what your old Mellotron is worth. Call or write . . .



MELLOTRON®

A DIVISION OF
SOUND SALES INC.



Sherman, Conn. 06784

serge modular

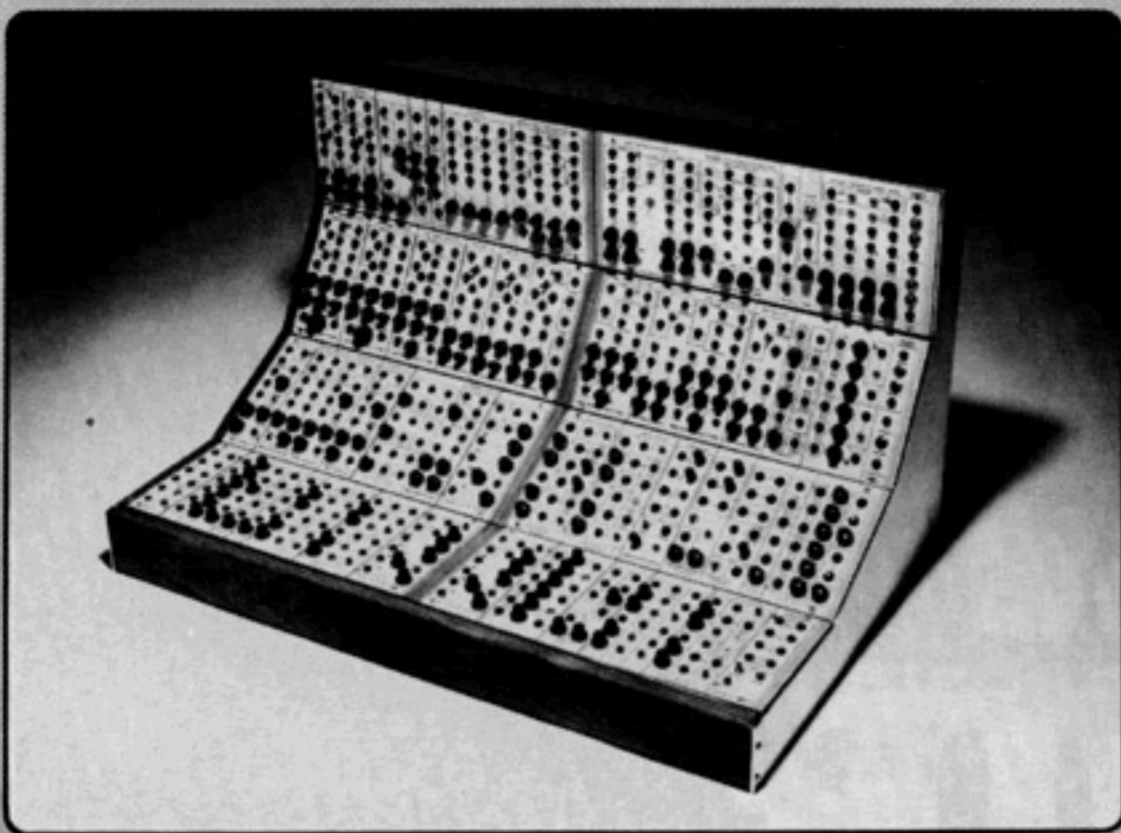

PHOTO BY BILL MATTHIAS

music systems

We'd like you to know about **Serge Modular**. We make what may be the most precise and versatile synthesizer system in use today. The Serge Modular is available either fully assembled or in money saving kit form. We made it modular, to assure that a musician (or video or computer artist, for that matter) can put modules together to fit his or her specific needs, and also to make room for future expansion of a Serge System. We adhere to industry standards such as 1 Volt per Octave VC inputs etc. to allow easy interface between Serge Systems and other synthesizers. We made it as versatile as we could within the state of the art, because we wanted to expand the possibilities of synthesis, not to limit our equipment to a few pre-patched effects. We made it innovative, because our pursuit of the highest quality allied to an affordable price made it hard not to be innovative, and because we are basically research rather than commercially oriented.

A few specifics about our hardware: We make the stablest oscillators, guaranteed over a temperature range of 40 to 100°F. And the trackingest. Our precision VCOs track within a cycle over the entire pitch range. Our VCA's and Panners feature over 80 dbS S/N and better than 60 dbS control rejection. Whether stereo, quad, penta or octo-phonic, our panners adhere to the equal power law for the smoothest and most accurate spatial location. Many of our modules are patch-programmable. This means that they can be patched to perform functions which in traditional systems would require sep-

arate costly modules. For example, our Dual Universal Slope Generator can be patched to work as envelope followers, log-linear saw, triangle and timing-pulse VCO's or LFO's, accurate VC portamento, VC pulse delays, envelope generators, and VC sub-harmonic generators. We use industrial quality components only, to ensure 100% reliable performance. **When we ship an assembled system, it is fully burned in, calibrated and guaranteed 2 years, parts and labor.** When we ship a kit, even an inexperienced kit builder is assured success, because we ship all pc boards fully assembled, tested and calibrated.

We wish we could tell you more about **Serge Modular**. Being innovative, and not necessarily falling under run of the mill categories, our modules may cause some consternation. Wherever possible, we'll gladly arrange a live demonstration in your neighborhood. (We find our customers are our best sales people.) If that's not possible, we'll gladly answer your questions by return mail. Meanwhile, you may wish to order a packet of information concerning Serge Modular, consisting of a variety of new product announcements, our catalog & price list, and a short Instruction Manual. All that we ask of you is to send us \$2.00 for the packet, and your name and address to:

Serge Modular Music Systems
1107½ N. Western Avenue
Hollywood, CA. 90029
(213) 461-7987

Book Review

Pieces 3, edited and published by Michael Byron, No. 240 Fine Arts Building, York University, 4700 Keele St., Downsview, Ontario, M3J 1P3, Canada.

In the summer of 1975 Michael Byron released **Pieces, an Anthology**. He had been a regular contributor and editorial counselor to Peter Garland's "Soundings" and this was his first solo venture. The book met with immediate success and was recognized as a major new source of compositions of exceptional quality. Electronic music has had a place in these publications from the first, although there are many problems in publishing electronic scores.

Perhaps the greatest obstacle is that so many composers who work with synthesizers use no scores and even when there are scores available they're only of limited use to others. Usually one would have to reconstruct the studio in which the piece was created in order to make another realization.

Michael's solution, it seems, is to concentrate on either scores which are descriptive in general terms of a process, or include circuit diagrams.

Previous issues best display compositions of the latter type. David Rosenboom's "The Seduction of Sapientia" appears in the first anthology in a realization for viola da gamba and voltage controlled resonators. A circuit for a voltage controlled resonator/envelope follower is included with the score. In the second anthology we find "Cell with Melody-Driven Electronics for David Gibson" by David Behrman. Here there are block diagrams and detailed notes about what goes on in the electronics without including exact circuit information.

The latest edition, "Pieces 3," features two works by Alvin Lucier which, though electronic music, make use of neither synthesizer nor schematic. Both of these scores are

prose descriptions of events which combine somewhat standard electronic music devices in a unique manner, thus setting up an event where the performer improvises within bounds prescribed by the given situation. This use of standard musical electronics can be seen in some similar works by John Cage—"Cartridge Music", or David Tudor—"Rain Forest." In fact there is an entire genre of live electronic music of this nature which shuns sole reliance upon the voltage controlled synthesizer for concert work.

One of Lucier's works is entitled "Music on a Long Thin Wire" and was commissioned by The Crane School of Music, State University College at Potsdam, New York, for the Live Electronic Music Ensemble, directed by Donald Funes. The score describes a musico-electronic sculpture, an "electronic monochord" of No. 1 Music Wire (or equivalent) extended across or lengthwise down a performance space. In a very clear, short, and lucid explanation we find described an easy hookup of amplifiers and oscillators "which explore the acoustic properties of a single vibrating wire." Simple alterations in volume controls and the wire's tension will result in "nodal shifts, echo trains, noisy overdrivings, rhythmic figures at low frequencies, phase-related time lags, simple and complex harmonic structures, larger self-generative cyclic patterns, stops, starts, and other audible and visible phenomena." An impressive catalogue of art from a modest technology.

Although instrumental pieces and occasional articles predominate the anthologies, the electronic works presented display a completeness in both thought and execution. Perhaps *Pieces* will devote more space or even a whole issue to electronic music scores in the future, and if the works already published indicate the quality to be expected from future *Pieces*, then anything Michael Byron chooses to print is worthy of attention.

—Bob Davis

Stockhausen

from page 12

would be like, hearing stories about The Man and all, having a gossamer image of what he is like; but I didn't find some untouchable deity bringing forth the powers of the universe,

but merely a man doing his music—great music. And after years of Gesang and Telemusik with Discwasher in one hand, Zerzap in the other I found Stockhausen to be right:

"Records are like postcards."

—Scott Morgan



David Bowie "Heroes"

RCA AFL 1-2522

"Heroes" is David Bowie's thirteenth album in ten years and marks his most fully realized change of direction, consolidating and expanding the innovations of the "Low" album. Bowie's music has always been marked with a strong tendency towards the schizophrenic—a juxtaposing of opposites that never quite synthesize into a well-rounded form. One particularly thinks of "Ziggy Stardust" and "Aladdin Sane", Bowie's role-playing albums, at once extrovertedly urgent and almost hysterical, yet at the same time vulnerable and introverted. This tendency is particularly prevalent throughout "Low", where Bowie's temperament collides with Eno's subtler, more impressionistic personality to produce an album of startling contrasts: the rhythmic, disco-like short studies of side one, and the longer, synthesizer dominated instrumentals of side two.

"Low" however was an uneasy experiment. Many of the pieces seemed to be unfinished doodles, and the Bowie-Eno partnership was clearly tentative and unformed, the latter really playing second fiddle to Bowie's dabblings into "art-rock". "Heroes" is an altogether different story. At least Bowie seems to be collaborating with, rather than just using, his musicians. As well as Eno on synthesizers and keyboards, Bowie features Robert Fripp (ex-King Crimson) on lead guitar, Carlos Alomar on rhythm guitar, with Dennis Davis (percussion), and George Murray (bass). Fripp and Eno have already collaborated on two albums, and "Heroes" is as much their work as Bowie's.

Like "Low", the album was recorded at the Hansa by the Wall studios in Berlin, and is divided into a rock song format on side one, and a largely instrumental side two of Eno's synthesizer, accompanied by Bowie on sax and koto, the latter being an interesting Japanese stringed instrument that is plucked to pro-

duce very percussive, atonal sounds. All of the individual tracks represent Bowie's most pessimistic vision of society since "Diamond Dogs", yet the two sides develop the ideas in different, juxtaposing ways. The first refers back to most of Bowie's rock influences from the past, the second looks forward, beyond rock, to new horizons.

The opening track, "Beauty and the Beast", is clearly influenced by Bowie's recent collaboration with Iggy Pop. It could easily be a cut from the latter's album, "The Idiot", which Bowie produced. The mix is heavy and muddy, the vocals emulate Iggy's, and the disco rhythm completely overshadows Eno's synthesizer. Fripp's treated, heavy-metal guitar underlines the theme of urban paranoia and displacement: there is slaughter in the air and protest on the wind.

"Joe the Lion", "Sons of the Silent Age", and "Blackout" portray a nightmare world reminiscent of The Velvet Underground's New York. All of these songs are abstract, non-narrative studies, using random phrase juxtaposition, very similar to Bowie's lyrical technique on "Aladdin Sane". The characters are psychopathic, isolated and junkied, they live in bars or in their cell-like rooms, contemplating murder or suicide. Musically the tracks are dominated by Fripp's searing guitar, sounding very much like Roxy Music's Phil Manzanera, and the punchy rhythm section of Alomar, Davis and Murray. Bowie's vocals are at their most hysterical—almost over the edge but not quite. He chants, speaks, or shouts the lines, free associating, but reminding us at different times of Iggy, Nico, and even Tony Newley. "Blackout" alternates crooning with manic vocals, underlining the inherent schizophrenia in Bowie's music, mentioned earlier.

The title track, "Heroes", provides a brief respite from this harsh reality, and is the album's standout track. If we can fall into dream-like introversion we can drive "them" away and be kings or queens—heroes for one day, immune to bullets and oppression. The track is essentially the rhythm section of The Velvet Underground's "I'm Waiting for the Man", overlaid by Eno's synthesizer, the only track on side one where Eno is given any prominence—as if Bowie was using him to represent the introverted nature of the song. Bowie's vocals are again almost out of control in the second half of the piece.

Side two represents Bowie's retreat from rock and roll, and by association, from his past. "V-2 Schneider" forms the bridge with

side one, a tongue-in-cheek mélange of 1960's funk with '70s electronics. Booker T and the MGs meet Kraftwerk-or Stax Memphis meets Kling Klang-as Eno treats the rhythm section and sax with phasing and synthesizer.

"Sense of Doubt", "Moss Garden", and "Neuköln" follow, forming a trilogy of impressionistic sound, fusing Bowie's and Eno's ideas most successfully and inventively. Bowie has already announced his debt to Tangerine Dream and Edgar Froese's solo albums, and their influence is most pronounced here: creating colorful textures and washes of sound, overlaid by treated sound effects and more cutting interludes that add a feeling of insecurity to Eno's synthesizer. Thus "Sense of Doubt" features a Liszt-like piano leitmotif; "Moss Garden" the koto over Eno's flute-like background; and "Neuköln" a wild saxophone, sounding like a ship's siren, in duet with the synthesizer.

The album closes with another song, "The Secret Life of Arabia", a return to the style of side one, with the synthesizer mixed down below the disco rhythm section. This may be Bowie's last look back into his past as he hopefully explores further, with his new collaborators, on his forthcoming album, to be recorded in Tokyo. As ever with Bowie, we are left wondering what on earth he is going to do next.

—Colin Gardner



Tomita Kosmos

RCA ARL 1-2616

Tomita's latest album is an uneven collection of musical styles. In keeping with today's media preoccupation with science fiction, Tomita has put together a group of synthesizer arrangements and realizations that are vaguely unified by the association each has to space travel. However unified the subject matter is, musically there is little in common among the selections.

The album starts off with the main

title from "Star Wars", but the version that Tomita seems to have taken his arrangement from is not that of the movie soundtrack, but rather that of Meco's disco cover. A rhythm box pervades most of it, although in the middle Tomita gets sidetracked by R2D2 and C3PO's chattering and singing "Fur Elise".

After "Star Wars" comes a group of riffs by Strauss and Wagner (2001, The Ride of the Valkyries, and the overture from Tannhäuser) arranged by Tomita, entitled "Space Fantasy". This one again is quite unfocused. Nothing crass or anything like that, but eminently forgettable none the less.

Next is "Pacific 231", which Tomita plays rather straight. This one is a vivid interpretation of Honegger's piece about a steam locomotive, to which Tomita gives celestial implications. A masterpiece of a realization. In Ives' "Unanswered Question" Tomita creates an impression of freefall, that drifting sensation that is the result of not having a gravitational pull. Again, a nice realization, with drama and a sense of urgency. How Tomita could put these two gems on the same record as that dreadful "Star Wars" is beyond me but at least the entire record is not like the latter.

"Aranjuez" and "Solvejg's Song" are both pieces in a sombre mood. The lead line in the latter reminds me of a bassy electric guitar, a nice voice. Voicing and timbre are things that Tomita is best at, his technical virtuosity is always excellent, the sound extremely spacious and clear, despite the large number of discrete tracks used in his recordings.

"Hora Staccato" was recorded with the aid of a micro-computer and is intended as a cheerful piece to show that the impending computer age will have a positive effect on our civilization. However, it sounds like ice skating music to me, a rather mechanized genre even when performed by human hands. "The Sea Named Solaris", from the Russian film, ends the album, and is a beautiful complement of the music with Tomita's impression of the film: the sea that is alive and the men that live with it.

Most of these pieces carry over the blast offs, flight instrumentation (random modulation sequences), whistling, talking, singing, and phasing, and other effects from his last effort, the space fantasy, "The Planets". As before, the music seems frequently to be only a vehicle for Tomita's dramatic vision. Not that there is anything inherently wrong with this approach, but without a unified musical score such

turn to next page

from page 15

as Holst's. Tomita's theatrics lose substance and ultimately degrade the music they are intended to enhance.

It becomes then a question of conception and interpretation, with which I frequently disagree. Perhaps Tomita should record an album of his own compositions. Having to start from scratch might help unify the music and subsequent realization, although the little pieces on his Japanese album, "Sound Creature" (RVC (Japan) 7564/7565 2 records; one consists of previously released Ravel and Mussorgsky, mixed in Bi-Phonic, the other contains a few short original pieces but mostly a track by track breakdown of his process of realization that is quite enlightening), offer little support to this argument.

— Danny Sofer



Brian Eno Before And After Science

Polydor 2302071

"I notice that many of the more significant contributions to rock-music and, to a lesser extent, avant-garde music have been made by enthusiastic amateurs and dabblers. Their strength is that they are able to approach the task of music-making without previously acquired solutions and without a too firm concept of what is and what is not musically possible."

— Brian Eno

What was there before science? Magic. Nowadays, when theories have been stretched tight as drum heads over observations and statistics, then played upon with technology's mallets, what is left? Magic, if you know where to look. Brian Eno. Eno creates music with an artistic blend of thought and carelessness; one finds surprises not only in the music, but frequently in his execution of the music. I seldom write record reviews. That I've chosen to put in print my opinions concerning BEFORE AND AFTER SCIENCE surely indicates the

depth of my feelings for Eno's work. Unfortunately I also have strong feelings about music 'critics'. In the spirit of American composer Charles Ives, I say, who are we to tell music how to sound?

During my writing, these feelings occasionally would turn viciously inward, resulting in a state of mind closer to catatonia than creativity. Once when this happened I consulted a deck of oracle cards called Oblique Strategies. These small, black and white cards were created by Eno and associate Peter Schmidt in 1975. Intended as an aid to creative work, they contain a number of vague suggestions, amusing instructions, questions and statements, such as, "Honor thy error as a hidden intention", and "Mechanicalize something idiosyncratic". One of my favorites is, "Go somewhere else". According to Eno the cards were used a great deal in making this album. The idea is to break down overwhelming problems by stimulating creativity through random process. Example: you are stuck at a certain point while composing or recording a piece of music. Pick a card. Does it apply to your problem? If not, pick another and try to connect the two in a way that does. Even if the readings don't always strike home, the cards are useful as a device—similar to a mantra; concentration shifts, the mind relaxes for a while, and mental blocks dissolve. Anyway, the card I picked told me, "Don't be afraid of things because they are hard to do", so I forced myself to keep writing.

Eno is probably best known as a founding member of Roxy Music, a band whose name symbolizes for many the ultimate fusion of avant-garde and rock styles. A self-proclaimed "non-musician" (i.e., no formal training), he used tape machines, synthesizer components, and presumably any other available devices to alter music being produced by the other band members. In addition, he played the synthesizer. Lacking a strong background in traditional keyboard techniques, he was free to attack the synthesizer as an instrument in itself, with an expansive spectrum of sound, and few limitations. The results were highly imaginative, and can be heard on the first three Roxy Music albums. Since then, Eno has been involved in many projects, including appearances on records by former Roxy members Phil Manzanera (guitar) and Andy Mackay (sax/oboe). He has played concerts with droning guitarist Robert Fripp (ex-King Crimson), and recorded several solo albums of material ranging from humorously demented rock songs (as on *Here*



"The other House," one of four four-color prints by Eno's collaborator Peter Schmidt included in "Before and after Science."

Come The Warm Jets), to experimental works involving self-contained musical systems (*Discreet Music*). The founder of Obscure Records, he has recorded and produced the work of several other artists and groups. His instrumental treatments, synthesizer, and influential presence are noted on albums by John Cale, Genesis, and most recently, David Bowie.

Before And After Science finds Brian surrounded once again by a large, flexible team of excellent musicians. Percussion and rhythm are dominant factors on side one, as evidenced by 'No One Receiving', a Bowie-esque tune lamenting alienation "in these metal days". Typical of Eno is the haunting synthesizer riff buried beneath the bass and percussion, and audible at an almost-subconscious level. Synthetic percussion blends well with Phill Collin's echoing drum licks to form seething layers of sound.

'Kurt's Rejoinder' bounces like one of those big, multi-colored plastic balls they sell in Thriftymart, kicked along by Percy Jones on analog delay bass and Shirley Williams on brush timbales. Eno babbles in the background. Both 'Kurt' and the next cut, 'Backwater' have terrific melodies, melodies that a child might write, if a child had a sophisticated enough sense of rhythm. 'Backwater' is pure fun; the fluid stream-of-consciousness lyrics should appeal to anyone with a well-developed sense of the absurd, and the beat is infectious on an epidemic level.

'Energy Fools The Magician' is a short, moody piece, seeming to

have escaped from a longer, moody film soundtrack, and 'King's Lead Hat' is discordant and noisy enough to be classified "new wave"; its mindless drive and energy make it similar to material on the previously mentioned *Warm Jets* LP, released in 1973. Interestingly enough, Eno's vocals here remind me of bass player John Whetton, who performed on *Warm Jets*. (Eno has always been an innovative vocalist; his phrasing is unique, and he sometimes does imitations. On an earlier album he sings a line or two like Roxy's vocalist, Bryan Ferry.) Another point to ponder about 'Lead Hat' is how many rhythm guitars are being played? At first listening I'd have guessed ten, but I might've been, shall we say, over-sensitive at the time.

Side two is more "mellow" (throwaway lines often ring true), with an emphasis on Brian's more gentle vocals, uncomplicated lyrics, and some very pretty songs. Acoustic and electronic instruments settle comfortably together throughout the entire side. Moog, Mini-moog, and AKS synthesizers are used subtly; they sigh, drift, and occasionally meander into the dreamy realm of ambience, as in 'Julie With', my favorite cut on the album because of the synthesizers and the mood they help to induce—that of being stranded, timeless, floating on a raft with a girl somewhere. Eno plays some tasteful guitar on this one.

Notable, if only for being pleasantly different from anything else I've heard him do, is the opening cut, 'Here He Comes'. It's probably as close as Eno will get to The Eagles—close enough.

'By This River' is my second favorite cut, featuring Achim Rodilius, Möbei Moebius, and Eno, all on keyboards, a trio managing to sound like a single pianist. A nice effect. Brian's vocals are soothing, and the song has a distracted, lilting quality:

"You talk to me, as if from a distance and I reply, with impressions chosen from another time, time, from another time . . ."

'Through Hollow Lands' has Fred Frith (late of Henry Cow) playing slow cascades on guitar, and 'Spider and I' is a perfect closing piece. It could be a sing-along. Eno employs a rich, soaring combination chime/drone chorus, and the result is near-hypnotic; the song makes you sway . . .

I tend to question the way *Before And After Science* was recorded. No noise-reduction systems were used, and unfortunately the record

seems lacking in textural and spacial aspects when compared to some of his others, *Another Green World*, for instance. Also, those interested only in synthesizers may be a little disappointed; the album doesn't sound as electronic as one might expect, but then why should it? In the spirit of Charles Ives. . . Besides, Eno's music embodies something more important than mere technology; it holds a 'realness' borne of efforts to create something other than the ordinary. Brian Eno has invented another universe of music both entertaining and challenging to a listener. I urge anyone interested in advanced musical expression to listen to *Before And After Science* several times, regardless of whether you like it on first impression. Wait a week, then listen again. Listen very quietly, behind closed doors. Listen with your mind on something else. Listen at high volume, listen at low volume, You may hear something different every time.

May you hear something different every time.

—Andy Capraro

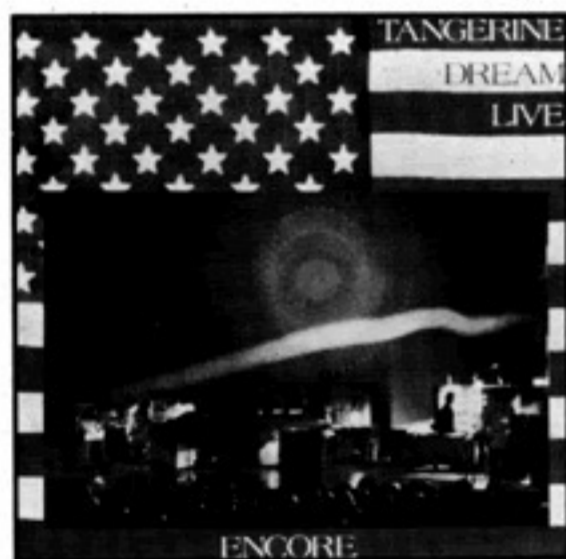

Tangerine Dream Encore

Virgin PZG-35014

Perhaps the singularly most characteristic and oftentimes irritating aspect of Tangerine Dream throughout their recorded history, has been their inconsistency. This LP tends to personify all facets of that nature. Ideology concerning the creative process and its applications has always been an integral part of the band's approach, and this album frequently comes across, at certain critical moments, like a sonically sculpted ideological battle. Segments do not always mesh well and the aural geist is one of rupture between the boundaries of heaven and hell, leaking through, piecemeal, into mirror worlds of both the sacred and profane.

When the band visited Santa

Monica's Civic Auditorium last spring, replete with an accompanying Laserium light-show, there was much favorable speculation by the press. Much of it turned to chagrin when the appearance went down as one of the year's big disappointments. The sound system was overbearing, the improvisations were more pre-programmed repetition than they were substantial. When not pre-programmed, the bulk of the playing was directionless and unmoving. The total picture was one of a group of less than consummate skill providing a blustering orchestration for the Laserium's retina-frying photon mantras.

With "Encore", TD's gathering of highlights from that tour, little of that overdrive-sloppy sensibility is manifest. The sound textures, (though not always conjunctive) are clear and precise for a greater part of the release's four sides. Three sides, "Cherokee Lane", "Monolight", and particularly "Desert Dream" have both Haydnesque, Nuremberg Egg precision that was so eminent on Baumann's solo LP, Baumann, who has since departed the group, did the final mix on this collection.

Despite the uneven sound of struggle between methods of attack that comes through on "Encore", there is a great deal of the delicate, membranous nature about the music that is part and parcel of Tangerine Dream's better efforts. "Desert Dream" is notable for its usage of Mellotrons and PPG to lend the proper moody, minor-key fluidity that pays strong tribute, in its tone-poem aura, to the arid desolation and purity of empty space denoted in its title. "Monolight" has its inspiring moments, particularly in the segue between a zippy little Schubert-like melody that dissolves into an uptempo blast very reminiscent of the "Betrayal" theme from "Sorcerer". Isolated spots on both of these pieces are as interesting as they are a painful testament to a band literally ripping itself apart with diverse and irreconcilable energies.

As with most double LP's this probably would have made a much stronger single disc release, the other two compositions sounding suspiciously like the Santa Monica date and being no more than fillers. One can attribute their presence, particularly "Coldwater Canyon" with its interminable and amorphous Froese guitar-riffing, to the same differences of opinion that caused Baumann to take his leave.

Baumann's is the strongest, most recognizable touch that can be felt on this release. Within the rigid borderlines of his decorative structuralism, a great deal of freedom can be heard. Now that he is gone, it will

be of interest to see how deeply his absence will be felt, and just how much of an impression the tension of his presence really made.

—Frank Gavin

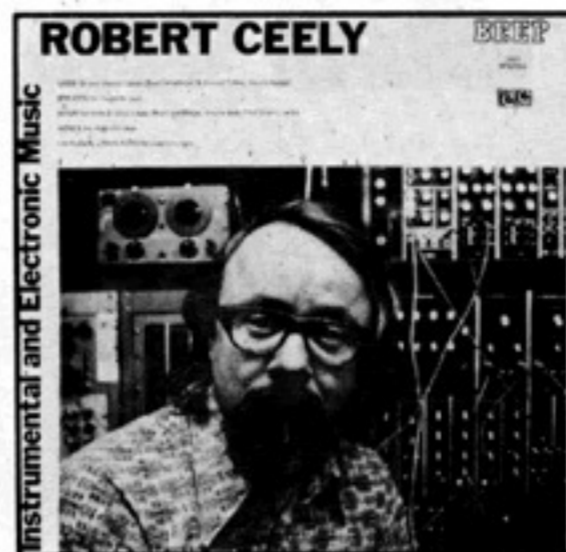

Robert Ceely Instrumental and Electronic Music

Beep 1001

This recording is an example of how simplicity loses its virtue. The album contains two entirely instrumental tracks which turn out to be the most interesting on the disc.

"Logs" (1969) for two double basses (reminiscent in title and idea to Paul Chihara's Logs, from "Tree Music"), creates a most delicate performance with well expressed nuance and subtlety, each instrument emanating from a different speaker. This is followed by "Stratiti" (1963), a tape piece composed at the Milano Electronic Music Studio, which utilizes as its main compositional idea the development and change of various envelopes.

"Hymn" (1970) for cello and double bass, provides an articulate and enjoyable interaction between the instruments. The two acoustic compositions do not seem so much out of place with the rest of the music, but rather demonstrate a different and more sophisticated level of performance when compared to the electronic works.

"La Fleur, les Fleurs" (1975) takes up the entire second side. The work begins with repetitive gamelan timbres which seem to be the result of a sequenced or tape looped patch, interspersed with excessive cheap spring reverb and rather primitive reverbed frequency modulations. The super thin texture is particularly vulnerable to poor signal-to-noise ratio and other recording problems. A new developmental section consists of sample and hold sine tones which are reverbed and configured in tape loop fashion. This section contains occasional Satiesque brusqueries and other devilish combinations of

tones. Timbres imitate the contrasting tone colors of high flute, piccolo, clarinet, and the sounds of a typical 20th century percussion performance. The final section suggests the sounds of city streets, and steel vs. steel but generally consists of thin, oversimplistic frequency modulation.

Electronic musicians and composers do not have at their disposal the more exotic recording facilities of commercial studios. As a result, their recordings may suffer in signal-to-noise ratio, poor dynamics, and may develop a higher than average rate of ticks and pops. Mr. Ceely is encouraged to improve the audio quality of BEEP's discs.

—Alex Cima

NEW RELEASES

Genesis

And Then There Were Three
Atlantic 19173

Cluster and Eno

Cluster and Eno
Sky Records 010

Time Zones

Richard Teitelbaum
(with Anthony Braxton)
Arista AL 1037

Iowa Ear Music

Cornpride Records, P.O. Box 2655,
La Jolla, Cal. 92037

Peter Brown

Do You Wanna Get Funky
With Me?
Drive 104

Hawkwind

Quark Strangeness And Charm
Sire SRK 6047

Far East Family Band

Tenkujin
All Ears Records

Michael Hoenig

Departure From The Northern
Wasteland
Warner Brothers BSK 3152

David Rosenboom

On Being Invisible
Music Gallery Editions, 30 St. Patrick
St., Toronto, Ontario, Canada

Barton McLean

Dimensions II for Piano & Tape;
The Sorcerer Revisited; Genesis
Orion ORS 75192

Barry Truax

Sonic Landscapes: Electronic
and Computer Music
Melbourne SMLP 4033

Edgar Froese

Tangerine Dream, the most visible synthesizer band to date, has attained mainstream exposure through concert tours, the soundtrack for the film "Sorcerer" and album sales. Indications are that T.D.'s forthcoming album, as well as a possible soundtrack for an American Sci-Fi TV series, and a European tour that may come to the U.S., will keep their image public.

The image though, will not be the same. With Peter Baumann gone to pursue independence and two new members, one a drummer, things are going to look different if not sound different. But as for the latter, Froese says he is surprised by the results.

by Frank Gavin

Synapse: *What have you been doing of late?*

Edgar Froese: What are we doing? Right now, preparing the next recording session for the new album. We begin working the 3rd of January. A European tour starts the 17th of February; it may go to the States as well, at least at this point it looks like it.

Synapse: *On the liner notes of the "Sorcerer" soundtrack, William Friedkin was talking about how he sent you the script and you sent him your tapes; your impressions of his work. Were you pleased with what came of your work?*

Froese: To be honest with you, and I always try to be honest, even though it can

often be a bit dangerous, perhaps for the image of the band, but I don't like the film. Maybe it's the way the music fits into the picture. I saw the original version, Henri-Georges Clouzot's "The Wages of Fear" which was released in 1953, and it's made just too much in the same way. I thought there would be something new. It's terrible because we are living in a new age, a new time, and the story means nothing to me at all. Men travelling across untravellable roads with explosives. It's so unrealistic. Nobody would do it today. The situation, for us, was quite amazing. What group has the chance to create music for a full-length Hollywood feature? It's a great thing . . . but on the other hand, we are so close behind our music, with what we try to do, what we try to explain through our experience. So if it's for a regular feature, or just a short, or a T.V. series, it has to be together. It has to be in sync, and we just weren't that satisfied.

Synapse: *I thought the album quite good, completely apart from the film.*

Froese: We were a bit afraid of that situation, too. We did so much to explain the script—we were working quite hard on that music, and the way it fits into the picture, it's just totally away from the explanation we attempted.

Synapse: *He used some of Keith Jarrett's "Hymns and Spheres" too.*

Froese: That's the other point. I like Keith Jarrett's music. I really love this crazy, genius keyboard player. But I think it would have been possible for him (Friedkin) to inform the band that he was using someone else's music as well. Which he did not do.

Synapse: *He didn't let you know till later on?*

Froese: Not until we saw the film for the first time in L.A. We were quite surprised.

We thought "My God! Where have we played that? Recorded that?" We didn't know—we just could not place that interlude or two that later turned out to be Jarrett.

Synapse: *You've heard "Hymns and Spheres"?*

Froese: I bought it afterwards and I really love it. It's recorded in a church in Germany.

Synapse: *Do you think you'll ever do a soundtrack again?*

Froese: There's a plan to do the music for an American science-fiction T.V. series. Negotiations have recently started. I don't know how far it's progressed. It might be a good chance to get right into the mainstream exposure.

Synapse: *On your "Macula Transfer" (3rd solo LP) the dedication reads to "David Bowie, Iggy . . . and the ghost of Chopin". What's the significance behind the dedication?*

Froese: I have a very strange story concerning that. I've never talked about it before. I'm not sure if it's good to talk about it . . . anyway: I was together with David for maybe half a year. I would visit him in the Hansa by the Wall studio, where he recorded the "Low" album, and when he recorded Iggy Pop's record after that—it was the first time I got to meet him for an extended period. We got into some strange discussions about music. And he came to Berlin, and stayed here for about a year now . . . we saw each other periodically. A kind of friendship developed between us, and there were possibilities that also developed of working on a project together. So far, because of the impossibilities of commitments there has been no chance.

Synapse: *I noticed the direction he has been taking as of late, has not been one*



PHOTO BY BILL MATTHIAS

"I am more a musician than a technician."

-Edgar Froese. Shown with Chris Franke. (l.).

too dissimilar to your own . . .

Froese: Yeah. He came up one day with my "Epsilon in Malaysian Pale" record and told me how much it had influenced him. It was quite strange, I didn't expect it from a guy like David. But I think after "Station to Station" he made quite a strange jump into a new area.

Synapse: *What do you think of the direction he's taking?*

Froese: I think it's quite hard for him to do it. He's definitely lost a lot of his followers. One has to decide though, if one wants to go just for the kids, or as you get older, to do something else. I think it's a very personal decision. It has nothing to do with the business.

Synapse: *Outside how it affects his popularity, do you like the direction in which he's going?*

Froese: I like it.

Synapse: *I think "Heroes" is yet another step upwards from "Low".*

Froese: Yes. I think so too but one of the problems is, unless you know something about the process, how much the work of Fripp and Eno has affected his sound, it is difficult to take the transition.

Synapse: *I have a feeling that what he's doing, what you're doing, what Eno's doing is indicative generally, not saying how it will wind up, of the way mainstream music is going. It has the force of technology behind it . . .*

Froese: Yes, I think that's true. Oddly enough though, I remember around Christmas of last year, Eno stayed in Berlin for a couple of days, and came to visit during rehearsal in an old cinema we'd rented—and it was such a strange exercise. We realized we could never work with him, and he could never work with us. Yet he could work with David. Strange isn't it?

Synapse: *He just approaches the use of electronics from a different angle than you?*

Froese: A totally different angle. I suppose it sounds pompous, but we've really studied it, for around five years. We've spent a lot of time and money on the study of the technology that makes possible what we're trying to do. We realized very early that to get behind all that stuff, and make it work for you, it needs to be "trained" very hard. Otherwise it's just a gimmick. Like writing a pop-song and putting some electronic sounds on top of it.

Synapse: *Like Donna Summer and her producer?*

Froese: Yes, yes. Everyone mentions that. They all ask "well, but what do you think of Donna Summer, using the sequencer on that one number?" It frustrates me, in a way. It took us maybe five years to perfect the beginnings of possibilities of the use of sequencer in combination with other sounds and devices. Somebody comes along, giving it what is to me, at least, a very simplistic treatment of the device, and suddenly everyone takes notice, only because it happens to be the decoration around a pop melody.

Synapse: *I imagine her producer had more than a little to do with that.*

Froese: Yes. I know Giorgio Moroder. That's the kind of thing he's into, really. Pop-production values.

Synapse: *I can see what you mean. I had never looked at it that way before. I'd begun to think of it in terms of a step in evolution. That mainstream breakthrough with the use of electronics . . . one that you undoubtedly helped to create.*

Froese: Yes, yes, I suppose. But how often will the sequencer be used below its potential now? We certainly didn't get any formal recognition for it. And how many had used it before us? It had only been used in a very academic setting for the most part. Walter Carlos and a few others . . . it's just all very frustrating to me.

So anyway, we went through the whole technical side for about five years. You have to learn so many things, and it's very hard. You have to learn so many things which in any other case, you would be totally uninterested in. Personally speaking, I feel I am more a musician than a technician. But you have to learn about all of these knobs and switches and technical functions. It's terrible. I hate it.

Synapse: *I imagine it would involve a lot of mathematics.*

Froese: Yes that. I hate that too.

Synapse: *I used to hate it too, until I started getting interested in it . . .*

Froese: Exactly, exactly. And the first success you get in the field is just to realize whatever you put into these machines is what you get out. If it's done in great earnest, with some knowledge, it can be something very creative, and new; right at the moment. And it's the first step of success. And after getting that, you then want to get even more out of these technical gorillas. So you keep working, you keep working and in the process you forget how hard it is. You may reach a certain level of satisfaction, but you keep going on . . .

Synapse: *You've increased the amount of equipment you use by quite a bit since "Phaedra" haven't you?*

Froese: We started in 1971 with just one small synthesizer which was built by the EMS company in London. A VCS3—Voltage Controlled Synthesizer. Now we use about twenty-six different types on stage. The one big problem that came up since that time has been the impossibility of walking into a shop and being able to buy just what we needed because we'd bought everything that was on the market and the bigger companies said they couldn't do modifications just for us because it's very expensive. So we founded a little

please turn the page



“Chris and I asked him what he wanted to do.”

factory here in Berlin, with three or four people behind it, called “Projekt Electronic Berlin” and they fill any of the custom-requirements we may have. They have made the synthesizers that fill most of the essential needs. The way we did it was to draw up some diagrams of how the functions should be, what sort of filters we need, how many oscillator banks, which way the envelope should work; things like that. They worked out where to get the single materials. Some we’ve got from America, others from England, others from France; so we’ve collected everything everything we need from all around the world. Now we have some very sophisticated equipment.

On the other hand don’t forget one thing. They are never creating anything by themselves. A lot of people may think, if they see a big synthesizer like the “Projekt Electronic”, all they have to do is look at it and a beautiful sound comes out. Nothing comes out that at the very least hasn’t been programmed into the machine. And if you want to run the same program or programs through a whole tour, okay, you can do that. But it’s not very creative and not very satisfying so you don’t do that. So you set up a new program for each concert and that takes maybe two or three hours every day. And it can’t be done by a road crew. They’d have to have as much background as you and even then how are they to know what direction you want to go in the next time? We do have some pre-programmed arrangements but it gets very boring using those things. One of the ideals Tangerine Dream has had through the years has been to improvise, never ever play one concert twice.

Synapse: Like Keith Jarrett, in a sense.

Froese: Yes exactly. It’s better that way—more human, more creative.

Synapse: You told someone in another interview, who had compared you to Pink Floyd that you disagreed on the point that they were too structured.

Froese: We started nearly on the same platform as they did, relating drug experiences

and all the so-called psychedelic stuff. But then we moved away from the area that begins when you compose set-pieces and play them every night. It makes you ill, kills your creativity. So the way they’ve moved into the commercial areas—I can agree: I know some of the reasoning, I’ve met these guys. I can understand why they have done it. But as far as it being part of the music—music is like a process. It and you should go on to create something new.

Synapse: I suppose it’s understandable, even though I think they stagnated a few years back. They probably got tired of being in the red, of owing everybody money all the time.

Froese: Yeah. And they can’t even see each other any more.

Synapse: Really?

Froese: Yeah—I mean they’re so far apart in their personal attitudes now, even right down to their tastes and convictions in music. Dave Gilmour has become increasingly interested in folk-music and just regular guitar-stuff. And Nick Mason—is a drummer, if you know what I mean; and most of the material, I think, is done by the bass player. It’s quite a strange relationship they’ve got. From a personal stance, outside the business, it can be very easy to criticize someone, to say, “Oh god, what good music they did a couple of years ago, and now they do that commercial shit”; I’ve heard it. I know why it’s done. But if you know why it has been done; what sort of problems a band could get into after being together about ten years, it’s very normal to—

Synapse: To want to eat?

Froese: Sure. Even if you become successful, money can do a lot of strange things to people.

Synapse: And it cannot buy creativity. I think a group of people, no matter how creative they might be, can only work together so long before the friction wears down.

Froese: True. And that’s one thing that might be quite new for you—because

we’ve had the same problems with our band. We reformed the group four weeks ago. There was a very hard discussion inside the band about getting more commercial as opposed to staying uncommercial. Peter Baumann had built another studio, wants to get more into the production side. Chris and I asked him what he wanted to do—did he want to progress in music or did he want to get into his studio and produce some hit singles? So we left it for maybe three months and then it was apparent that he could not make a clear decision. So we told him, “Look, we want to go on, we need to progress, so perhaps it’s better that you leave”. So that’s it. We’ve added two other members, and are a four piece group now. One is an Englishman, who played in the very early days of Steamhammer, Steve Jolliffe. He will be playing electronic sax, a lot of synthesizers and keyboards. A very accomplished, all-around musician, and has been working for about ten years, writing and playing. Also, we have added a drummer. That’s quite strange, isn’t it?

Synapse: Yeah. I remember you saying around the time of “Phaedra” that you were through with all “the silly things,” meaning drummers and bass-players.

Froese: But it’s not a normal drummer-situation. It’s going to utilize a lot of electronic percussion and conventional percussion, particularly a device known as a trigger-tom. The trigger-signal runs straight into the synthesizer and can reshape the drum sound into something else. It can be rigged to switch a little computer so that the signal runs into another instrument and can influence it after the wave-form has been altered. We did it because we want to get back the emotional part of playing an instrument. One of our trademarks has been the sequencer, and that has been what has been creating the bass-lines, what in effect has been our rhythm section. But it does run very automatically, in regular beats, and if you want irregular beats you can have them, but it’s still not very emotional, it’s just pressing buttons.

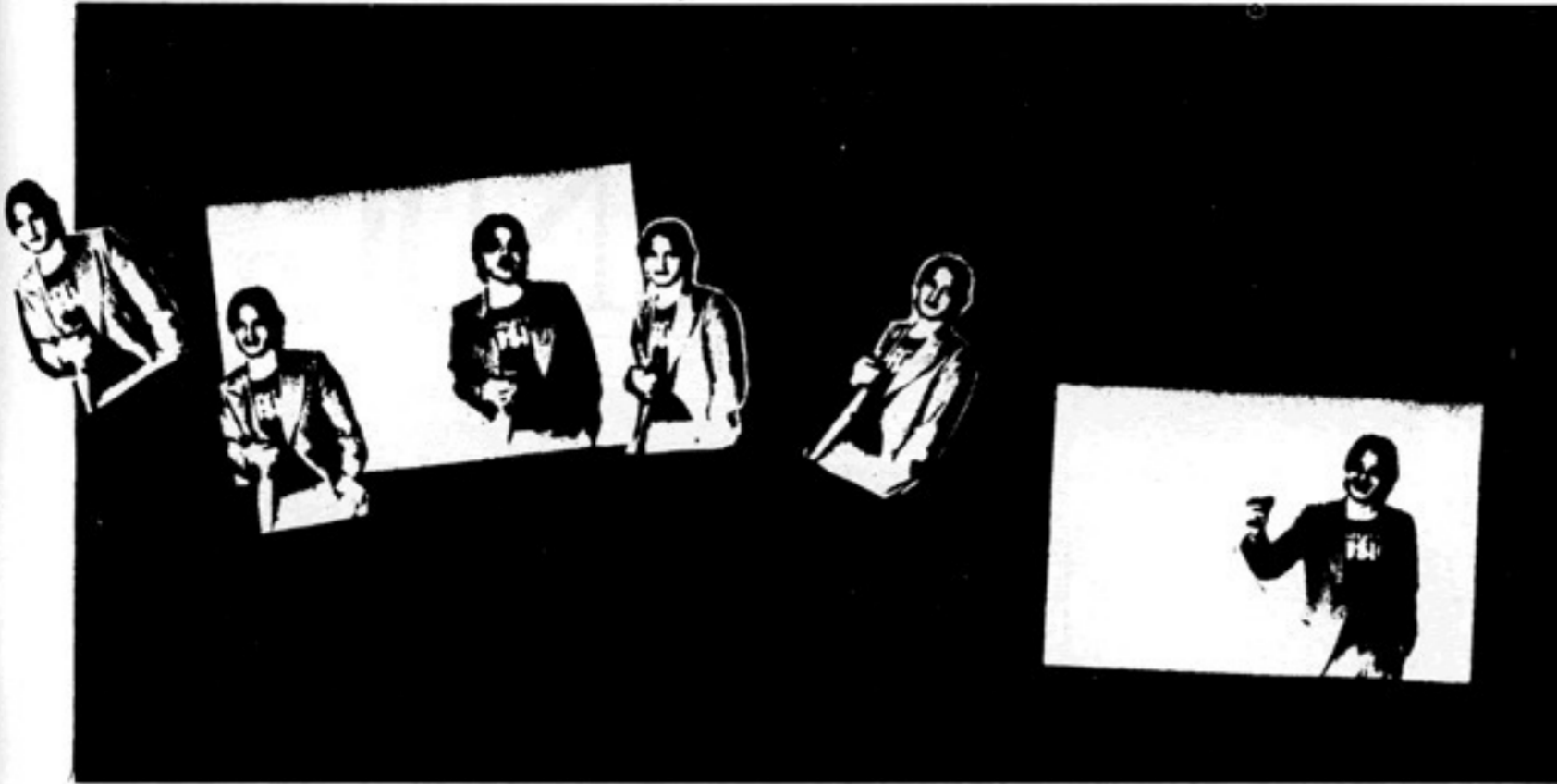

PHOTOGRAPHS BY BILL MATTHIAS

It's better now if we do it by a drummer, if it's a human hand, with sticks, controlling each impulse.

Synapse: *A bit more fluidity?*

Froese: The sound hasn't changed that much, you must realize, but there's a pivot of emotion, of feeling through spontaneity that the sole use of automation does not provide. I was myself, very surprised at the results. We've been rehearsing together for about four weeks. Then the studio dates come up in the first week of January for a new record. But it's made us very happy that we can still progress, and don't fall straight into a repetitive, commercial market thing.

We've been together about six and a half years. And we've earned quite a lot of money. It just didn't affect Chris and I that much. Peter was a bit different. He liked having a lot of money and travelling around the world. There wasn't enough time to train the fingers and the brain. We weren't together enough to practice as a unit, but we've got everything back now.

Synapse: *So Peter is going to work more with production, then?*

Froese: I think so. That's what he wants to do. He has stopped working, as far as I know, on anything of his own. And he has produced some material for someone else. He has, as I said, built a bigger studio in Berlin, and I think he just wants to work with it. I think it's better than boring each other.

Synapse: *You worked with Klaus Schulze at one time?*

Froese: Yeah! The first album we ever recorded, "Electronic Meditation"—very strange—released in '70. He played just drums at that time. After that he wanted to get off the drum kit, and more into the keyboards.

Synapse: *I really like the "Mirage" lp he released last year on Island.*

Froese: So do I. I think it's probably the best thing he has ever done, clearer and more precise.

Synapse: *What music has influenced you the most profoundly?*

Froese: Classical. Again, we are not into making a big thing out of it, but we're all classically trained from a very early age. Since childhood. I like Bach, Johann Sebastian to be specific. Has to be the greatest bass-player of all time. Haydn. Schubert. A lot of the Romantics. Chopin, Liszt, Mendelsohn, the Impressionists, Debussy, Ravel and so on. Moderns, Bartok, Schoenberg, Stravinsky, Xenakis and Boulez, whom I am really fond of. Medieval chorale fascinates me; plainsong and polyphony like . . .

Synapse: *Gregorian chants?*

Froese: I love Gregorian chants.

Synapse: *It's shown through a great deal in your use of voice tapes, I think.*

Froese: They're so pure. I get up in the morning very early, usually just as the sun comes up—a good time for them. Gregorian chants.

Synapse: *Do you think you'll get more into the use of live voice more perhaps with this new ensemble?*

Froese: I would like very much to, yes. We've been thinking about it. I just wouldn't like to see its use, if we were to take it up, or the use of anything we do, to become so standardized that it takes on that "hit" quality. It might well become a trap, if that is what our livelihood depended upon.

If you do what you want, and it's really done strongly, with conviction, maybe the audience feels it too, and knows whether or not you just want to fool around. If it's really serious, then people may agree to it on your terms, and with the years, some success. Maybe not enough to earn millions but to get enough to live from. That's all you can ask for. That's all I want. Maybe someday posterity will look back upon you and see your work as something very important, something historical, maybe even something timeless. But you don't even think about that, because it makes you self-conscious. You don't worry about the fame now, or posthumously, or the money as long as there is enough for your art. You simply do it, and do it honestly. ©

EMS VOCODER 2000
for the treatment
and modulation of human
speech and the production
of speech-like effects from
music or other sounds.
Used by radio, television,
studios, groups
and theatre.

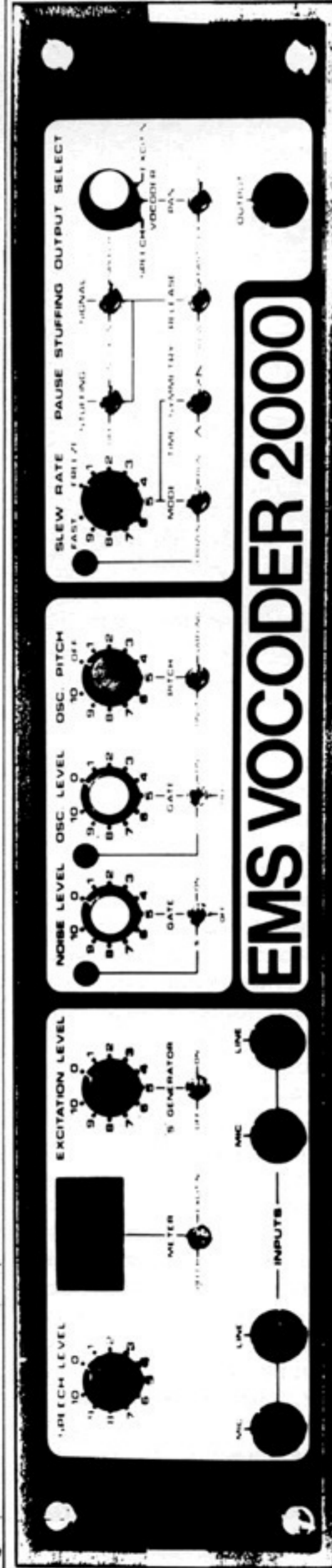

Zen On Music Co Ltd
25 Higashi Gokencho
Shinjuku-Ku
Tokyo

Electronic Music Studio Supplies
5832 Westminister Avenue
Montreal
Quebec H4W 2J8

Piano Center
122 Rue de Paris
Montreuil 93100
Paris

"No
United States
agent yet."

EMS West Germany
7257 Ditzingen 3/Hiemeringen
Finkenstrasse 4
07152 - 53273

EMS
The Priority
Great Milton
Oxford
08446 - 729



MICHAEL HOENIG

Michael Hoenig's first Warner Brothers release, *Departure From the Northern Wasteland* (BSK 3152), may well represent a new milestone in the introduction of American audiences to electronically produced music. It may also introduce a school of consciousness that departs from the long term influence of "the blues" on contemporary popular music. Hoenig states that, "American pop music has been based mostly on the blues music of slavery, sharecropping and the ghetto." But he sees the emergence of, "A completely new musical reality where there is not only an inner musical context, but also a context of the global community. There is a new avant garde with an inter-cultural consciousness appearing. I like to call it 'metamusik', as it strives for a greater universality. It may lack the pain of a Coltrane solo, but it will project the vision of a more balanced universe where energies flow easier." This interview reflects Hoenig's global consciousness, and there is no doubt that *Departure From the Northern Wasteland* will decidedly affect the globe's consciousness of his music.

by Doug Lynner

Doug Lynner: *What were your influences when you were starting in music?*

Michael Hoenig: I was getting into everything. That was the time—'67, '68—when the student revolution came near its peak. There were energies flowing around, and you had to enlarge your sensitivity so that you could pick up on many sorts of energies, and decide what they meant to you. I was very much into writing, painting, photography, and I went to many concerts of new music. I was just interested in what you could call twentieth century art—everything that happened. I also remember that big art exhibition, Documenta, we have every four years in Kassel. All the things that happened there just turned me on. But in those days, I just couldn't apply it to any specific direction. I met a composer in Berlin—his name is Thomas Kessler—and he said that he was going to form something like Cornelius Cardew's 'Scratch Orchestra,' in Berlin. The idea was that musically educated people, as well as students, housewives, or whatever act together under rules that are extra-musical—something like, 'Go out in the courtyard, and sit under a tree, and play what the tree is like.' I didn't play any instruments in those days, and I was not interested in learning any instrument in a traditional way. So, I simply began with a zither that could be found in any fleamarket. I had contact microphones wired up to it, and as I was technically oriented, it was very easy for me to work with contact microphones by putting them into a tape recorder, into a spring reverb, or whatever. Then I fooled around with

musique concrete; getting different collages together. I began to build my own tone generators and ring modulators. I was experimenting with everything that was available sound wise as well as on the technical side, not in any specific direction yet, just to let energies that were there flow through me. A little earlier than those days, acid and dope appeared, and that had a certain influence. Well, we had some funny sessions with the scratch orchestra. I really enjoyed those completely free-form improvisations. Then, I met a guy from Agitation Free, a band that was already quite known in Germany, and they had just split up. Christoph Franke, who was the drummer in Agitation Free, had left to join Tangerine Dream, replacing Klaus Schulze, who then formed Ash Ra Tempel. He was, in those days, the drummer with Tangerine Dream. Well, I joined Agitation Free, and there were only two people left: the bass player, and one guitar player. We were also into free-form improvisations, not playing songs, just improvising. In those days, there were bands in Germany like Amon Duul, Tangerine Dream, Guruguru, Ash Ra Tempel that were into free-form improvisations that had a more or less rhythmic, rocky background; just looking for new forms, new structures, with a sort of policy never to play the same thing twice. Agitation Free was also used as an ensemble for avant garde composers.

Synapse: *Whose pieces did you perform at that time?*

Hoenig: For instance, that composer Doehl in Germany—you probably won't know him—or, well, we all played in a big Cage performance in the Berlin Philharmonic which was called Hpschd. There is a record on Barclay (a Paris-based record label) from Agitation Free, where

one side is a piece by Erhardt Grosskopf called Looping. Looping IV was the fourth version of Looping. Looping II was, for instance, performed by the Tokk Ensemble, Tokyo. We were just known as being open enough to play everything that seemed to be somehow interesting, or involved with new structures. The band then made a Middle Eastern tour under the auspices of the German Cultural Institute (the Goethe Institut). We played the first rock concert ever in Cairo, which was a great experience.

Synapse: *What was the Middle Eastern reaction to the improvisational music you were doing?*

Hoenig: Oh, it was absolutely marvelous. The reaction was so much different than what we were used to. People were really not only enjoying themselves, or freaking out, or letting their own trips go; those people were really into listening. They came up after the concert and asked, for instance, about musical details that we almost forgot after the improvisations ended. I remember very well that they had such precise questions as I never got before that, or a long time after that. A very concentrated audience. Very nice. We gave some introductions that we were not playing just straight songs, and they were all really quiet and nice, and they were very, very perceptive and so thankful that they had the opportunity to hear something different. On that tour we played Cairo, Alexandria, Beirut, Tripoli, Aman, Nicosia, and Athens.

Synapse: *What year was the tour?*

Hoenig: That was 1972. From that point, Agitation Free got a recording contract with the publishing company that owns the Wergo label. They had a licensing deal with Vertigo (Phillips). Our



PHOTO BY BERND KAPPELMAYER STUDIO

“When those first Berlin albums came out, there were no terms by which to judge them.”

first album, 'Malesh,' was very much influenced by that tour to those Middle Eastern countries. It got very good reviews, but Vertigo didn't really work for it, because it was a licensing deal, and they had their own bands like Atlantis in those days, so we actually had more success outside Germany. We had more concerts in France in those days than in Germany. We had more tours there, and we played wonderful venues. We played, for instance, the Opera Comique in Paris, which was a triumphant success. The French audience was very much into German rock between '72 and '74, and Agitation Free, together with Tangerine Dream, Can and Amon Duul, was one of the first bands that opened the whole thing up. We found the French audience much more receptive to improvisational styles.

Synapse: *Even in the rural areas?*

Hoening: Yes. And, well, the strange thing was, as we got more and more successful, the improvisation didn't work out anymore. We actually played and

exposed the energies and the tensions the musicians had amongst themselves, or those that we felt surrounded with. Once we went to the country for two weeks, and always had a tape recorder running. We were interviewing each other, and we were talking and discussing, and everything came to the top. It was very obvious when we played after those discussions, that our music lived off the tensions the musicians had amongst themselves on various levels. So we cut that together for a radio show that was 1½ hours long.

Synapse: *The tapes of . . .*

Hoening: Yeah, those tapes, with the discussion and the music, and it was a really marvelous experience to see how it worked. It was really where the music came from. But then it turned out that the more concerts we had, the less tension there was because we just played the gig, went to the hotel, fell asleep, went to the next date, and played again. What could happen in between that? I must say that band began to just imitate the best structures it already had played. As soon

as we realized that, the band stopped.

Synapse: *Was that when you started playing with Klaus Schulze in Timewind?*

Hoening: We were doing Timewind, and we were touring. The actual record, 'Timewind,' is not that group, so the name of the band was later the name for one of Klaus' albums. Klaus and I were in some musical things completely different. We were very close friends, but we split, and then immediately it came up that I should join Tangerine Dream instead of Peter Baumann.

Synapse: *And that was for only a short period of time?*

Hoening: In March or so, I left Agitation Free. I played a half a year with Klaus until October-November. I think we played the last gig together in Paris in the Salle Wagram. Right after that, I joined Tangerine Dream for an Australian tour, and a Royal Albert Hall concert.

Synapse: *I think that 'Departure From the Northern Wasteland' will often be compared with Tangerine Dream, Klaus*

please turn the page

MICHAEL HOENIG

Schulze, or possibly Jean-Michel Jarre because of the musical relationships between the albums on some levels. I want to discuss, first of all, where some of the similarities and common influences may be coming from. For instance, on the most basic level, the predominance of the sequencer is something that will remind people of Tangerine Dream. How do you see your use of the sequencer as being separate, or different from their use of the sequencer?

Hoening: Well, I actually split from Tangerine Dream with the thought that I would go more into composition from that time on. Tangerine Dream was still very much into improvisation and I felt somehow that that time had passed for me. It just didn't give me back enough compared to what I was putting into it. When people put all the electronic music together that Klaus Schulze, Tangerine Dream, myself, Manuel Goetsching, and Ash Ra Tempel did, I think it becomes clear that something developed over there that could be described as the 'Berlin school' of electronic music. What we are doing now is still basically influenced by the late '60's and early '70's, when everybody was into experimenting and searching for new structures and new sounds. Nobody wanted to play the same old songs with their defined and narrow messages. That time simply demanded new ways. The first similarity people will see in Berlin electronics, is the similarity of sound colors—of that typical Moog bass, for instance. I'm sure it's still too new for people to really have terms by which they can differentiate between pieces and judge whether they are good in their own sense, or even played well. When those first Berlin albums came out, there were no terms by which to judge them. You could judge them in terms of avant garde music, or in terms of commercial music, but neither works. I think it's just a question of time how long it takes before people can differentiate the colors and structures. I would simply say that my work is very much different from Klaus' and Tangerine Dream's from an internal musical standpoint. I have a feeling that my music is much more composed, and the structures are more directed.

Synapse: To paraphrase, the first big difference would be that you have been moving away from improvisation, and therefore have become more interested in orchestration, and in exact relationships, as opposed to approximate relationships.

Hoening: Right. That's very true.

Synapse: I would think that that would have a lot to do with defining the listener's

experience, in terms of what you present them with.

Hoening: Yes, well I didn't think of that in the beginning. I was involved in all that avant garde music, and knew what was happening in that scene. I was looking around for which things would last, and which things would not last. Some friends of mine and I were very much interested in the relationship between old folk music and its influences on avant garde music.

Synapse: What do you feel those influences are?

Hoening: Well, to describe it as a general phenomenon that seems to happen in many places, those influences are very heavily reflected in five or six American composers that I admire very much and they are, for instance, Terry Riley, Steve Reich, Phillip Glass, Lamonte Young, and Bob Moran. There are many people in this country who just got back to basic musical sources, as I would say. And there is one sentence from Steve Reich that describes it very accurately, which says something like 'The clear tonal center and the basic pulse will re-emerge as basic sources for new music'; and it couldn't be better said. I agree with that completely. So knowing those people, listening to Eastern music, listening to rock and avant garde music, and seeing what I was doing—where my mind and my emotions were drifting in improvisation—I simply got more interested in older European, African, and Indonesian folk music structures. In time, I began to arrange patterns that had certain similarities. Basically what comes out is something that is an element of African music: rhythmic cycles of the same, or relating length, each with its own separate downbeat. Or something that I like very much is a drifting downbeat; for instance, a five note pattern with the downbeat on every six. If you have several of those cycles, it gives an overall moving structure with a certain endlessness, or infinity, and that can make your mind drift too. The other thing is a clear tonal center which is related to, for instance, Indian scales. If you listen to the piece 'Departure From the Northern Wasteland,' it is strictly in c minor. It is absolutely strictly in that scale. All the harmonies and melodies are built from that scale with no other pitches. I found that this provokes a certain basic magic with a very relaxing influence. These are energies that have been known for thousands of years in all folk cultures; but the basic pulse, for instance, has been completely lost in Western music since the fifteenth, or sixteenth century. And after Organum and Perotin—1100, in Paris—the clear tonal center was also lost. I think the clear tonal center and basic pulse are

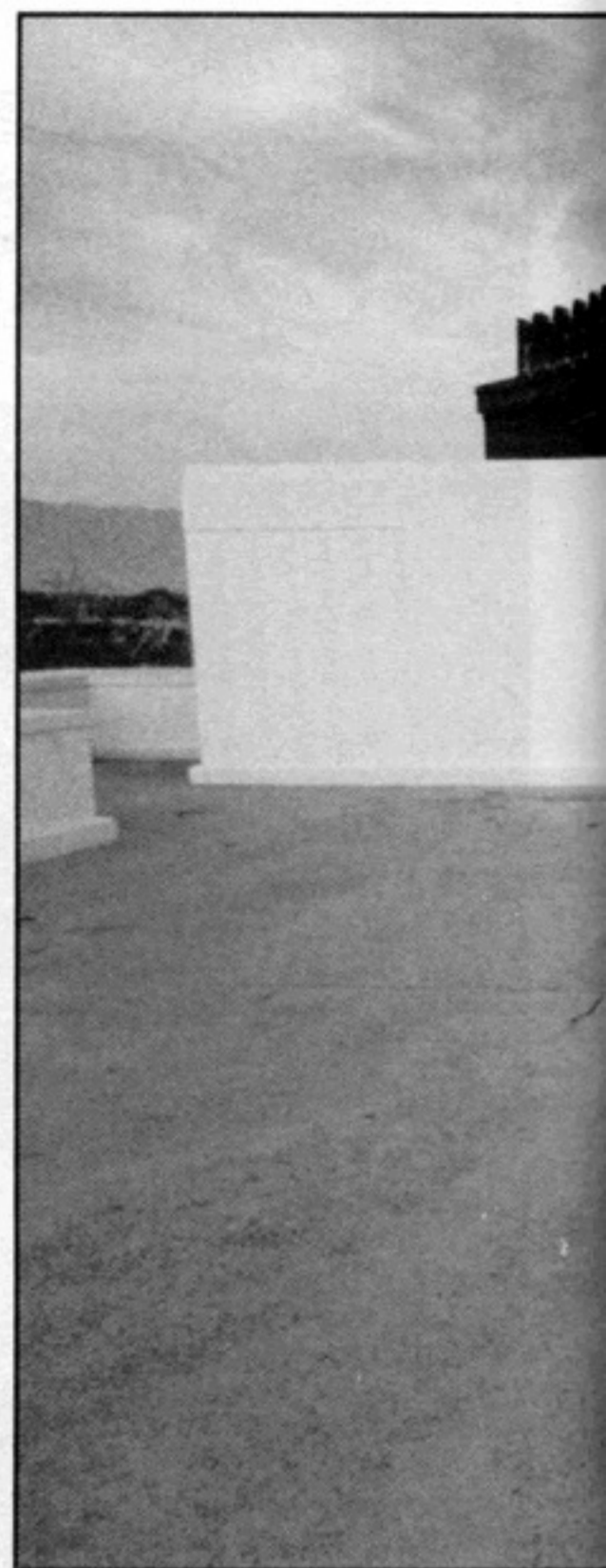

**“We actually
and the tensions t**

just coming back, and more and more people are realizing that this is going to be a very heavy new energy. It's going to be a new form of music—metamusik with an up to now unknown universality—and it's just the very, very beginning.

Synapse: On your new disc, the piece called 'Voices From Where' is to me the most interesting piece on the album in lots of ways; but one respect is certainly in how it differs from other pieces on the album. There is not really a clear pulse, but there is a clear rhythmic cycle that's being dealt with, except, I believe they're phasing, aren't they?

Hoening: Yes.

Synapse: There are two tape loops and . . .

Hoening: No, it's not two tape loops; there are several. There are some tape loops, and some are played in real time. Many people ask me about the voices at the end of the piece. It is basically a poem; a collage concerning time. The other thing is basically the Yamaha organ played in very low cycles, very slow, as loops, each with its own time base.



PHOTO BY CHRIS AUGUST

...played and exposed the energies the musicians had amongst themselves.”

Synapse: *How do you, within the piece, envision the connection of the voices and the instrumental material? They are both looped, and they have a rhythmic relationship, but why do they exist in the same piece?*

Hoening: I worked on both as separate pieces, but they were created in the same period of time. Emotionally I felt they had a connection. I only know that this piece reflects a time of utmost reduction musically, as well as socially. The distant choir-sounding part is just one sound color within one octave, slowly moving upwards; the rest are some words concerning the phenomenon of time. And when I finished the two parts, I realized both had the same time relation, and a basic interior energy that is very similar.

Synapse: *At the point where the piece changes from the instruments to the voices, there are the . . .*

Hoening: There are those flying things.

Synapse: *Were they originally on either piece, or were they made as part of the transition?*

Hoening: It was part of the transition.

It was a question of how to make them flow into each other. As you might have noticed on the whole album, the melodies and rhythms always flow into one another. So that was a link. It is just to switch you somehow to another level. I can only describe it with other experiences I've had with the piece. I've played it to people, and some just relaxed, and some got afraid. It got into their heads—those drifting voices. Their minds drifted, and if your mind drifts, those who can't relax simply get afraid. Those who can relax get even more relaxed, and feel very happy, and just enjoy it. So this piece is actually the strangest, I think, on the album. I enjoy it very much. I think it's fantastic that this piece is going to be distributed by an entertainment label when the music itself is not entertaining in the same way as most music in the rock market. I would never have thought that this would be possible. I really love it. Tape loops were one of the first things I was doing in '68 or '69. Everyone worked with that, everyone could do it. And, as this is on the album, you can see the whole album,

especially the piece 'Departure From the Northern Wasteland,' is a conclusion, or roundup of ideas that were in my mind for a long time. I think there are so many different elements in that piece, that I actually needed much more time to play them out; for instance, that rhythm phase. I mean, you can make a 10½ hour piece of just that. I just had to put everything in there. That's maybe why it's so rich.

Synapse: *I would like to talk some about the actual technical processes that you went through with the synthesizers, since many of our readers are synthesizer players. But first, I'd like to find out what equipment you used on the album.*

Hoening: The equipment I used—and this should be very encouraging, for everybody—is very, very basic stuff. I was very technically oriented, and I was always into new equipment, but one day I simply said, 'Stop it, and just use those things you have, and get more into the music than into the hardware.' I used a Yamaha YC 45D organ, two Minimoogs modified in such a way that I can trigger the VCF and VCO envelopes separately; and a Moog sequencer unit with a sequencer, two sequential controllers, a sequential switch, and interface. I also used an Elka Rhapsody, modified so that I can switch or blend the amount of modulation, and an EMS Synthi A with the DK-1 keyboard. In the recording process, I used a 3M 8-track M 28, an ITA 8-track, an ITA 10-into-4 mixer, and a speed control Revox, with digital read-out, so that I could precisely reconstruct delay rhythms. I must thank some people who gave me the opportunity to use their machines. I had all the production facilities at hand. It was a great thing to have. I didn't have any studio costs, so I had twenty months just to develop my ideas. That's the technical side of it, which is really very, very basic.

Synapse: *It's interesting that it is so basic, because the album comes off being much more complex.*

Hoening: Yeah, it is much more complex because it is much more polyphonic, and much more polyrhythmic than most electronic music around. This, to me, is the biggest difference between my music and those groups we mentioned earlier. There's not only one line you can follow. People have told me that they have listened to the album ten times, and they're still hearing voices that they did not hear before. In fact, all rhythmic and melodic lines are played monophonically and, no matter which line you follow, all the others will fit perfectly as backing chords. Another element is that each melody line has something to do with the following one, and even the last one is related to the first one. The melodies are not just there by chance. I don't want to say that improvisation has no meaning, but

turn to page 36

Jean-Claude RISSET

Jean-Claude Risset is the head of the Computer Department of the Institute for Research and Coordination Acoustics/Music (IRCAM). Here Risset discusses IRCAM's goals, projects, progress and the political/social atmosphere that surrounds this center for progressive research in music.

by Doug Lynner & Virginia Quesada

Douglas Lynner: *What are the goals of IRCAM?*

Jean-Claude Risset: The IRCAM project started because Pierre Boulez thought there were many problems in contemporary music that could not be solved by individuals alone from either a practical or a theoretical standpoint. There was a need to face these issues collectively. There were many practical things to be investigated by several musicians in collaboration. Also important, is the collaboration of musicians, scientists and technicians in a very systematic way avoiding, for example, musicians resorting to what is available commercially or as a by-product of science and technology. There needs to be some thinking in common about building some tools for music that would really be not only by-products of techniques or projects developed for some other purpose. He (Boulez) really thought of it in musical terms. To be more precise, one way to look at it is the way in which Boulez organized this Institute in departments; each of which is supposed to conduct research in a specific domain. You can see, for example, that from its very name, the Computer Department is technically loaded, whereas the Instruments and Voice Department really doesn't necessarily require technology. It in fact will; there will be experiments such as there are here in San Diego with the Group for Extended Vocal Techniques, which really works basically with the body along with some microphones. Similarly, there will be some experiments done relating to instrumentalists that may not involve much technology. I'm saying this because many people think that IRCAM is really a big technical institution for music and it is in a sense—there is a lot of equipment dedicated to music, but it is not exclusively that. The idea is really to be not a production institute like some studios are. Of course, research is always involved in creation, but most of the time it is

research that is hardly communicable. Here, the purpose is to conduct research that could be valid or useful for a number of musicians and not only help some individual projects. Certainly music will be produced, but the idea is that the production be a consequence of research. The project that will be welcomed there will be a project which will have validity for a number of people. I guess that is a point of view that is disputable sometimes, but . . .

Lynner: *Do you mean, disputable in the actuality of IRCAM?*

Risset: No. What I mean is, Boulez thinks one should go against marginality. For example, he thinks that if you have to build one instrument for a piece, that's nice, but that's not applicable to the circumstances. He thinks that's a big drawback. There are examples that follow the contrary line. Harry Partch, for example, built beautiful instruments that, of course, are one of a kind. His music is contingent on these instruments, and they cannot be transported easily. I guess it is quite clear that Boulez thinks that this is a limit to the possible radiation of things, so he thinks it shouldn't be this way. The fact is, the classical instruments of the orchestra have developed to the status of, well, you might say, quasi-perfection. But they are not evolving beyond that because there is this sociological weight. There is all this music of the past that they are adapted to. We think one must seek new ways and systematically work to develop new instruments and techniques; adapt the means to the present goals of musicians. I should mention another point which Boulez makes. Okay, he doesn't want it to be a production institute in a way; rather research, with music as a result. But also he's very intent on having contact with the public. He finds that some institutions tend to isolate their research too much and in fact, he thinks that at some point

research has to be tried out on real people in real circumstances; not just in the small circle that is very interested in this research. That is why there is a big program of concerts for public presentation.

Virginia Quesada: *How is the public's response?*

Risset: Well, it's too early to say. We had this big series the first year that was a little traditional although there was a point made to sensitize the public to the evolution of music in the twentieth century, and to demonstrate that these developments were led to by a long evolution. Also there was an effort to attract a wider audience than usually goes to an electronic music concert, and this succeeded to a large extent. Many people are very interested in the new developments and they really want to know. The computer, of course, is frightening to many people. They can hardly conceive of it being used in music and we make it a point to be very candid about it and not to have any clouds over what's going on or any kind of mystique. I think it is a kind of commitment to make things very clear. One may perhaps say that at this stage the music is really evolving and it's not sacred as before, when we had this idea of the artist; this mysterious creation act. Now, people are much more interested in the making and also they like to have explained the motivation of the piece or point of the piece and indeed it's true that many pieces now try to make a point, much more than nineteenth century music.

Lynner: *Is that attitude of wanting to involve the public partially a result of IRCAM being a government supported institution? Does the government enter into what is going on there very much?*

Risset: In France we have many more government supported institutions than here, so that's not so unusual; but there is much less private support and maybe that's unfortunate because it may lead to the government realizing some directionality or some control. It is not clear how it will come out, but at this point there is no sign that this is a restraint. I guess that it is too early to say.

Lynner: *Is any of your equipment open to public access?*

Risset: At this point the answer is certainly no. There is a wish to try to make available at times some terminals whereby you could use a computer interactively and design programs. This, however, will not be the central pre-occupation of IRCAM because IRCAM is really more a research institute than an application institute. Hopefully, we will contribute to the development of some tools, instruments, synthesizers and so on that can be used in various ways including visitor operation of the equipment; but there will not be a large amount

NEW! GUITAR ★ BASS ★ KEYBOARD ★ WHATEVER YOU PLAY
The ULTIMATE RHYTHM MACHINE™ ONLY \$9⁹⁵

STOP PRACTICING ALONE!
 FINALLY...NOW YOU CAN PRACTICE
 OR COMPOSE WITH ONE OF
 HOLLYWOOD'S TOP STUDIO
 DRUMMERS.

DRUMDROPS™ IS A STEREO ALBUM
 OF DRUM TRACKS RECORDED IN
 ONE OF L.A.'S HOTTEST 24 TRACK
 RECORDING STUDIOS BY ONE OF
 THE FINEST SESSION DRUMMERS
 ON THE WEST COAST.

FROM BEGINNERS TO PLAYERS -
 DRUMDROPS™ WORKS FOR EVERY-
 ONE. IT'S FUN AND EXCITING AND
 GUARANTEED TO GET YOUR
 CREATIVE ENERGIES FLOWING.

DRUMDROPS™ IS A TOTALLY UNIQUE
 NEW CONCEPT

Because there are no other instruments
 on the album except for appropriate per-
 cussion such as: tambourine, cowbell,
 congas, shaker and timbales and there
 are no charts to follow. YOU CAN PLAY
 ANY SONG ON ANY INSTRUMENT IN
 ANY KEY. You are never locked into any set arrangement.
 Every 8 bars there is a drum pickup or fill for your verse,
 bridge, or chorus transitions. This basic arrangement allows
 you to be totally free for playing any lead sheet or for writing
 your own compositions.

VOLUME I INCLUDES 12 CONTEMPORARY SELECTIONS of
 music that range from hard to light rock through jazz and
 country. All tempos vary to capture the commercial feel of
 today's styles.

WHY DRUMDROPS™ IS THE ULTIMATE RHYTHM MACHINE.™
 Why pay hundreds of dollars for an electronic machine with
 outdated styles. For \$9.95 Drumdrops™ gives you...

- ★ real drums in stereo.
- ★ the count. a 4 bar intro and pickups and fills every 8 bars.
- ★ dynamics that you can't get from synthesized drum sounds.
- ★ fully orchestrated percussion to compliment your arrangements.
- ★ 12 completely different contemporary styles that you hear on the top recording artist's albums.

DRUMDROPS makes practicing sound like a performance -and
 a performance more fun than ever.

DRUMDROPS will upgrade your demos 100% with the drop of
 a needle.

DRUMDROPS - The only album for songwriting, practicing or
 playing any song on any instrument.



© 1978 All orders accepted Music Tree Corporation, 3420 Whipple Street, Atlanta, GA 30354

DRUMDROPS SELECTIONS

- | | |
|----------------------|----------------------|
| Side 1 | Side 2 |
| 1. Introduction | 1. Funk Rock |
| 2. Fast Disco | 2. Straight Rock |
| 3. Slow Disco | 3. Medium Rock |
| 4. Jazz | 4. 3/4 Country Rock |
| 5. Bluegrass Country | 5. Hard Rock Shuffle |
| 6. Country Swing | 6. Latin Rock |
| | 7. Rock Ballad |

MAIL TODAY!

DrumDrops Vol. 1, Dept. SN01
 P.O. Box 3000
 Woodland Hills, CA 91365

Yes! Send me _____ album(s) _____ cassette(s)
 DrumDrops Vol. 1. I'm enclosing \$9.95 plus 75¢
 postage and handling for each album. (Georgia
 residents add 4% sales tax.) Also add \$1.75 for
Air Mail Rush!

Make check payable to DrumDrops Vol. 1

NAME _____

ADDRESS _____

CITY _____

STATE _____ ZIP _____

IRCAM

WHAT ARE THEY DOING?

IRCAM is the fourth, and possibly least public section of the Centre Georges Pompidou, Paris, France. Established in 1969, and inaugurated late in 1976, the Centre was created to provide a contemporary art center in the middle of Paris, open to the widest public. Located in the large above ground building are museums, libraries, galleries, childrens' sculpture play areas, restaurants, etc. Next door, and to the south—underground in fact—is IRCAM. Although the advantages of acoustic isolation, and the conservation of the view of a Gothic church validate the subterranean construction, it is also ironic when the "underground" construction is considered in light of the controversy among the French people over the actual importance of IRCAM to French society, and the small

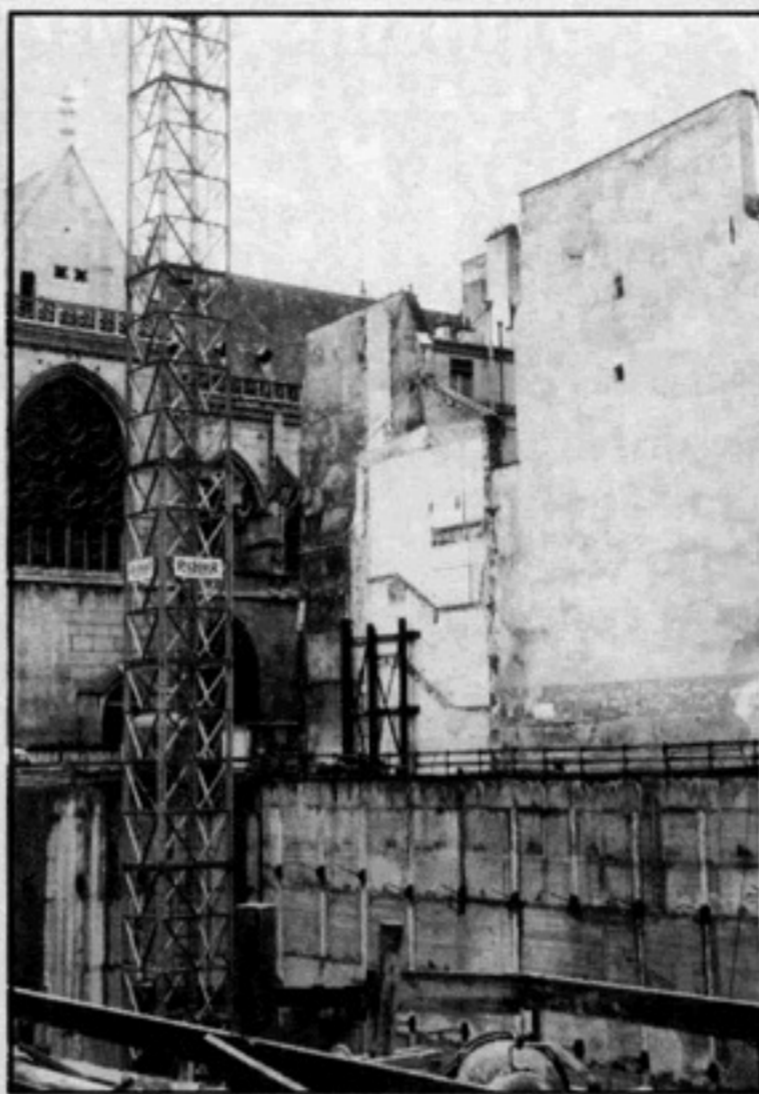

PHOTO BY JEAN-FRANCOIS PODEVIN



PHOTO BY VIRGINIA QUESADA

(Left) The Paris underground: IRCAM early in construction. (Above) "Since the project of IRCAM, there has been more systematic thinking about subsidizing other musical research institutes in France."—Jean-Claude Risset, Director of the Computer Department.

amount of communication the world's composers and performers have received from this institution.

IRCAM is designed to unite scientists and musicians with the purpose of conceiving and conducting research directly applicable to music and related subjects, such as perception. An important idea when one considers that much of current electronic music technology was developed for the aerospace industry. Also a rather

"utopian" idea, but one that IRCAM's director, Pierre Boulez, believes can be realized. He said, "The musician must assimilate a certain scientific knowledge, making it an integral part of his creative imagination. As to the scientist, we are, of course, not asking him to compose, but to conceive with precision what the composer or instrumentalist expects of him, to understand the direction contemporary music has taken, and to orient his imagina-

Risset

from page 26

of activity. We have too few people working at IRCAM to offer this. The rest of the Centre Georges Pompidou is completely public access. There is some interest in developing systems whereby the public can even contribute to the final form of the piece. This is in the future. This is a kind of "Utopia" which is quite reasonable to forecast now. Several people, including Boulez himself, have seen the experiments of Max Mathews with the possibility of interaction with the computer itself. Boulez himself said he would like to do a piece that would not be completed, but that could be assembled in several ways by the listener. Rather than be a finished piece, it would be a matrix of possibilities overseen by the composer. That would be music by a listener/performer and it could then introduce the listener/performer to a more active role.

Lynner: *Would there be terminals available?*

Risset: Yes, for example, and that again is Utopia; but I know Max Mathews has a considerable interest in using technology

to make new instruments available to the general public that could help start again a new kind of musical practice. Many of us find that practicing an instrument is extremely satisfying, but it is unfortunately very demanding. One can also play a record—that's great, but it does not provide much participation. Now, with the new technologies, one can foresee the possibility of a system whereby you could use the system just as a record player—just play the thing that's inside it—or just as a piano or organ; you just play all the things that you want to hear. But you could also have intermediary stages. For example, in conventional terms, you could have entered the notes of the music in the memory and the machine could play it back but while it's playing back, you could change the tempo, change the balance of the voices, change the timbre—a little bit like a conductor conducts an orchestra. I think this offers possibilities of a real musical participation without the need for as much technique. It could be a tool that would help people make music even though they don't have the time to really practice as well as they should to get a lot of rewards. Now, as I said, this is a bit of Utopia, but it's quite clear that it is feasible.

Quesada: *Does the composer, or a programmer create the software?*

Risset: Boulez has the view that a composer should not just be offered samples or possibilities that someone else has designed for him. It should be left to him to some extent, to design the instrument he is using, and we think that the way this is really feasible is to involve the composer in some programming. It is hard to believe that many composers will become programmers, but this would be in a high level language so that you wouldn't be required to be an expert. In general, it's easy for composers to take up programming. It is simply that most programming courses are given for engineering people, so the examples are taken from the engineering field—and that's where we have a problem. But it's quite thinkable and feasible to give musical examples instead of engineering examples and then we usually have no problem. We find that high level language programming is less difficult than counterpoint. There will be a group of courses that will introduce the composer to programming. I want to emphasize, however, that the technicians or scientists that have this special ability to understand musicians' needs, are very sensitive. I

tion along these lines. At educational meetings, scientists and musicians will become familiar with one another's point of view and approach."

IRCAM is divided into five departments: The Instruments and Voice Department, the Electro-Acoustic Department, The Computer Department, The Diagonal Department, and The Pedagogic Department. In the same order, their directors are: Vinko Globokar, Luciano Berio, Jean-Claude Risset, Gerald Bennett, and Michel Decoust.

The general research directions within IRCAM, both present and future, may be divided into these categories: digital synthesis on computers of general use; digital synthesis on specific appliances; instrumental studies; psychoacoustic studies; acoustics of presentation spaces; and modes of presentation of musical events (realized in "The Projection Space").

After Rolling Stone's slack-jawed statements about 1000 oscillators, Synapse felt it was time to take an accounting of IRCAM's activities. Here is an outline of research carried on during 1977, in as much detail as the current IRCAM communications allow.

First is in the area of digital synthesis on computers of general use. Among the developments in this area are the invention of a non-standard monitor for the PDP 10 computer at IRCAM, adaptation and scoring of an "editing machine," developing a

sound synthesis system based on the "Music V" program, plus the preparation of documentation and instruction manuals on the projects. Many programs for analysis and sound transformation have been developed by members of IRCAM and quest researchers, including programs for the mixing and digital reverberation of sound, the display and analysis of sound, and digital filter design. Work is also in progress on the means of entering programs for use with IRCAM's sound synthesis system, and the invention of a new system for D/A and A/D conversion, with 16 bit accuracy (realization 1978).

In the area of digital synthesis on specific appliances, work is in progress on developing a program for the system 4A, digital synthesizer designed by Giuseppe Di Guigno, as well as collaborating with H.G. Alles (Bell Laboratories) on the construction of a 4B prototype containing 64 oscillators, and 128 envelope generators. All oscillators and envelope generators operate in real time. It is claimed that, "this prototype represents the actual 'state of the art.'" Finally, there is the conception and beginning of construction of the prototype of system 5, the finite system.

In the area of instrumental studies, we find research into the physiology of circular breathing, the physiology of the piano, and the isolation of the sound of the flute. Of special interest to instrumentalists is the study of multiphonics. This study will utilize digital analysis and synthesis, as

well as psychoacoustic measuring programs developed at IRCAM to surmount the relationships of the acoustic structures of multiphonics and their perceptual characteristics.

Psychoacoustic studies and projects include the adaptation of classical programs for testing and measurements, such as INDSCAL, KYST, and HICLUST, designing an automated system utilizing the above mentioned systems allowing the investigation of all types of sounds, as well as the organization of an international congress on musical psychoacoustics, which includes 200 people at present and 55 papers presented to date.

The relationships of acoustics to space have been explored by creating an algorithm that represents the time and characteristics of reverb in relationship to complex spaces.

Future projects include real-time speech synthesis, and the completion of a portable, real-time digital synthesizer.

One thing can be said for sure—IRCAM is the most visionary music research institute currently in existence. What cannot be said, is who or what will benefit. It is hoped that IRCAM will disseminate the findings of its research not only to the established composers and researchers, but also to the rank and file musicians—the same people who will bring the whole idea to fruition. After all, "underground" is no longer in the vogue.

think Max Mathews has, for example, done a considerable amount of work which is extremely useful to the musician and well, Jim Rossum is now at IRCAM and he is developing a set of programs for the Di Guigno synthesizer, which is a little, powerful digital synthesizer. In effect, it's like a special purpose computer for sound, and over the analog synthesizer it has the advantages of precision, predictability, and, I guess, power. This machine has two hundred and fifty-six oscillators and that's useful because you can either use them as separate voices, or use them to do chorus-like effects. Just for example, you can desynchronize them slightly and get very rich textures and that's hard to do otherwise at this point.

Quesada: *That is being developed at IRCAM?*

Risset: Yes. And we have seen here at this conference that it is very much in the air and there are other places developing special hardware for music, like the Moore synthesizer, or the Samson. The Samson machine is a little different. It's more related to the computer, whereas, conceptually, the Di Guigno synthesizer could be used completely without the computer; however, it will be used with

keyboards and such real time devices, but through a computer. The point of the computer here is to first be able to program the controls. The computer that will be involved here will be a small—very small—LSI computer. That will be a portable system to have on the stage.

Lynner: *What other projects are you developing now?*

Risset: Well, this is not in the computer

"If there is not a continued relation with those places where technology happens, it could stay there. And it shouldn't."

area, but Globokar (Instruments and Voice Department) has several projects in mind, one of which is this way to produce non-harmonic tones with, for example, wind instruments, called multiphonics. It is a very interesting possibility that is very hard to control and to notate. For example, it's very much instrument dependent, and so notating the key that you press will not work for all instruments.

So he is trying to better understand the production of these sounds and maybe get to a more rational application one day. He has a much broader project which is to try to accumulate as much information about the instrumental and vocal techniques that have been developed all over the world. What Globokar would like to do is to accumulate this information; make some kind of catalogue so that these techniques are better known. They often are developed in one center and are not easily communicated, so there are problems of notating them and explaining how to practice to achieve those techniques. There is a continuing program of research in psycho-acoustics. Now, this has always been essential to using a computer—especially in the old days when you wouldn't get the output in real time, or even in a few minutes. It would take several hours to get your output, and so you had to determine what you wanted, give it to the computer, and the computer would eventually come back with a sound. In general, you'd be awfully surprised because one didn't know really how to relate the physical parameters to the particular effect. And in fact it turned out that most of the musical acoustics

please turn the page

Risset

from page 29

that were in the books were just meaningless. For example, instruments were all described as having different frequency spectra and indeed the frequency spectra were conspicuously different. When we tried to synthesize those on the computer, it all sounded like electronic organ. It turned out that this analysis was simply much too simple and they didn't take into account the variation of sound in time during the note, and that was sometimes more important than an average photograph or analysis. We proceeded to do an analysis of the sound, and it turned out that it was possible to imitate the sound very closely but there was a huge amount of information needed. So the next step was to try to find out what parameters are really relevant to the impression of the sound and this research is ongoing, but many big steps have already been made, and we understand much better what is characterizing such or such a sound. Now this is of value not only to imitate the existing instrument itself, but also to understand what is important to the ear. In principle, any sound in computer synthesis works by essentially copying the wave form. Originally, we just sort of fooled around with random parameters and didn't get much; they were not exciting sounds. I was very surprised. Well, we now understand why, because, simply, the haphazard path I am describing was not anywhere near what was important to the ear. We realized that hearing is not organized to just abstract parameters, but it abstracts much more complex relations. Hearing is a very important sense to be warned of what is happening, and, for example, one doesn't even think how hard it is for a machine to do the following task: A minute ago someone was screaming very loud, now, it wouldn't register on the VU meter very loud, and yet it's very easy for our ears to distinguish that loud distant sound from the soft close sound which may be of higher physical level to the ear, and this is very difficult for a machine to do. We are quite unaware that our hearing is doing extremely complex manipulation. Some of us think that if you don't give enough "meat" in hearing—enough of a chance to perform similar manipulations, there is something missing in the perception. Some electronic music, for example, has very simple tones without complex relationships built in them and when they are not enjoyed some people think, "Well, that's because we are not used to that," but I don't believe that. I believe that the sounds are not rich enough to involve the hearing process effectively.

Lynner: *How many composers have worked at IRCAM to this date?*

Risset: Well, that's very hard to say. You have the permanent people, but there is a rather limited staff so that it will be possible to have people from outside on a temporary basis—temporary would be from one month to maybe three years—depending on the nature and length of the project. Aside from staff composers, the rest of the permanent staff is mostly technical support; some being researchers at the same time. There are not really many research positions because we also like to keep that open. Some of these people are also composers, and in fact, when we can find hybrid people we do. We think that the interface between the composer and the technician is easier when there is some overlap of capabilities; otherwise it's very difficult. They really don't speak the same language.

Lynner: *Does the permanent staff decide who will work there?*

Risset: Essentially, yes. Now in many cases one member is especially interested in collaborating with a composer that has worked in such direction that he knows very well and of course he will have a strong weight in that field; but it is essentially a collective decision at this

"We think that the interface between the composer and the technician is easier when there is some overlap of capabilities."

point. That's a very important and very delicate problem actually because it is certainly true that while IRCAM hopes to be open to a number of people, it is limited nevertheless as a good place to work. There is quite a lot of interest in many applications for this project of ours. I think one can say that the principles that should underlie this choice are the basis of to what extent the project will contribute to the line of research that IRCAM is going to take in the state of the art, and also to what extent it corresponds to the equipment that we have in the most general sense. I mean, there are some places that are more specialized, should I say, than IRCAM, to do special things. It is also true that the IRCAM facilities can be very useful for other specific things—it's clear that this is something in favor of choosing those specific things. One example, I guess, is IRCAM's performance hall that will be variable in its geometry and in its acoustics. The ceiling goes down or up in three sections and each wall panel can rotate to provide one of three characteristics: absorbant, reflective, or diffused. By combining them one should be able

to achieve a wide variety of acoustic environments somewhat independently of the geometry. This, of course, has to be studied to know better which configuration is really interesting or useful for this or that kind of presentation. And it's clear here that there are lots of experiments that this hall is conducive to.

Quesada: *Is it finished yet?*

Risset: Well, it's not quite finished, but the ceilings are going up and down and the panels are rotating and incidentally, this will eventually be controllable by computer. We will also have to keep it manual because we don't want to have high technology, and then there is no electricity. Max Mathews has already designed a control system that essentially is able to retrieve very quickly a configuration that has already proven useful. So parts are operating, but it is not at all finished and when it is—maybe in a few months from now—it will take quite some time to understand the hall and have an idea of the possibilities. There are some theoretical predictions, and the hall was built taking into account these predictions, but still there is a lot to be experimented with. In fact, it's scheduled to open to the public not before one year from now, so in the meantime, one should tune it, or experiment with it. This will not only be a performance hall, it will be a real experimental hall and now, I understand, several people are interested in conducting architectural/acoustic experiments in there. By the way, the Diagonal Department is in charge of that space.

Lynner: *How will the information that results from the projects be communicated to those outside of IRCAM?*

Risset: Well, there are a variety of possibilities all of which exist at the same time. We plan, within IRCAM, public presentations to try to make accessible to the public the nature of the research and some of the results. Now, this is somewhat difficult sometimes, because you have to go really to very very explicit things. There are the usual ways scientific results are presented in technical journals. And a whole spectrum of possibilities like this. We do plan to have, for example, a list of technical reports available, some with sound examples.

Lynner: *Is there a publishing part of IRCAM?*

Risset: Not really. There is a publishing part of the Centre, but I'm not sure it can cope with all the needs that are there. And there is a project, which I want to mention here, to put out cassettes for the general public, some of which will be works, but some will be presentations on some issues of contemporary music. And the first one should come out within a year. I wasn't going to say too much about the publication plans because they are not completely settled yet, and I guess it will be tried out to see what works best.

But there are plans on a variety of levels like this, including the cassettes. I think we want to distinguish between the general public and the specialized musicians who are specifically interested and knowledgeable in those matters.

Lynner: Was your background involved in computers prior to working at IRCAM, or were you doing computer music?

Risset: Oh, yes, well I have a background in music and science independently, and my first compositions were instrumental. I started to work at Bell Labs in 1964. Before that I had done some work on theory and things, but not very much with computers. But at that time I did a substantial amount of work with Max Mathews who was really the pioneer of computer music. He really made a lot of

possibilities available, and it was, of course, for me a very strong turning point because I was frustrated, for example, with the limitation of conventional electronic music and rather preferred instruments for the subtlety of manipulations possible. And when I went there with the computer it was clear that in principle, the possibilities were infinite. In practice, they were quite limited. That was the state that I mentioned when we didn't know how to evoke rich possibilities. At that time, I did a study on trying to imitate real instruments, not as a goal in itself, but for the insight into the sound. Since then I have been going back again and I've participated in the development and debugging and the use of the Music V program. Max Mathews developed it

in 1967 just to try to give people the incentive; to provoke them to distribute information on what they were doing on the computer. The point being that when you do a song on a computer, your computer score is at the same time the recipe for the sounds. So it's a good way to make your own personal psycho-acoustic knowledge more complete by just comparing the sounds as they are described with the sounds as you hear them. And someone else can directly deal with this score and use it as is or change things. The computer makes this exchange of information very easy. In an analog studio, you can make a patch to do such and such a sound, you get such and such a result, and they're all different in every

please turn the page

Synapse

**CINCINNATI
INDEPENDENT ELECTRONIC
MUSIC STUDIO**

DEDICATED TO ELECTRONIC
MUSIC SERVICES AND SALES

David McClanahan, owner
115 Calhoun Street
Cincinnati, Ohio 45219
(513) 281-9028

**NEW YORK'S MUSIC
DEPARTMENT STORE**
JUST A FREE CALL AWAY!
800-645-3518
SAM ASH MUSIC STORES

Buy direct from our 6 huge stores and warehouse. All musical instruments, amplifiers, electronic keyboards, discos, PA's, pianos, organs, accessories, music. Call for prices or mail your list of questions. NYC area residents, please visit us in person. NY state phone 212 347-7757. Since 1924

**AUDIO & MUSIC
SYNTHESIS
Experimenter**

Write for our
FREE flyer today.



digital is better!

Our KC-11 Keyboard Computer is the only keyboard instrument that synthesizes wave-forms digitally for cleaner, clearer, more realistic sounds. Live onstage performance control is fast and accurate.

Presets, manual setups, plus tone cards expand discrete wave-forms infinitely — alternate between or mix all three! Included pedal assembly controls Envelope Latch & Speed, Staccato, Vibrato, Stereo Fade, Pitch Bend, Sustain & Percussion, while BOTH HANDS remain on polyphonic keyboard.

for information: RMI, Macungie, Pa. 18062

THE
BOSTON SCHOOL
OF
ELECTRONIC MUSIC

FOUR SEMESTER PROGRAM
OF ANALOG AND DIGITAL
AUDIO SYNTHESIS

First Semester Courses:

- INTRODUCTORY AUDIO SYNTHESIS
- MUSIC THEORY
- INTRODUCTORY ELECTRONICS
- PREPARATORY LOGIC AND MATH
- SURVEY OF ELECTRONIC MUSIC

THE
BOSTON SCHOOL
OF
ELECTRONIC MUSIC

28 HIGHGATE, ALLSTON, MA.
02134 (617) 782-9100

For Sale: E μ Digital Sequencer

Complete, including the following modules:
Programmer, Address Generator, two 512 stage memories (1024 steps in all) and Voltage Controlled Clock.

Includes instructional manual, AES preprint on compositional uses, and modest metal cabinet. Power supply not presently included, but can be supplied at cost. This is the current model and new price is \$1840 plus cabinet and supply. Make offer.

Pat Gleeson
(415) 864-1967
No collect calls, please.

Risset

from page 31

studio, and in fact, the possibilities are not equivalent. In a computer, you have more equal possibility and so with, for example, the Music V program, you send a score to someone far away and they understand everything. In '65 I did scores which I've taken back this year and I get exactly the same sound. So the idea was to communicate results and this did work in this center of research fairly well. I mean, there is a community of researchers that do not even have to be together to collaborate. For example, I started some research, or some studies on instruments that I didn't develop very much, and I like to see that at Stanford, Johnny Grey and Andy Moore developed this considerably further and by a kind of remote interaction; just by this distribution method.

Lynner: *Do you think that pure digital or analog/digital hybrid approaches to synthesis will be more prevalent in the future?*

Risset: It's hard to predict what will happen, but generally, things tend to stay on top of each other. I mean, there is much analog equipment right now, and it's likely to continue for a few years. I do think that most of the logic, most of the operations will be done, or should be done, in digital form probably less than ten years from now. Now the analog world, of course, is where you interact with the tools and I think that there will be many more newer means of control. I think you'll have pressure-sensitive and velocity-sensitive controllers and these are analog in essence, but I think they will go digital very early in the stage of things, because it's so much easier to do now. Even the recording may go digital, but at present it is still very expensive. But it's already potentially better because with digital recording you don't get the hiss, you don't get the degradation of quality with copies, and you also have ways of manipulating the sound if you want.

Lynner: *Is there any research at IRCAM concerning analog systems?*

Risset: No, I guess not. Well, no, I'm wrong. I'm wrong in that in the Instruments and Voice Department there certainly will be some attention to the instrument that will be analog, but even there it's thought that most of these attachments will not be a computer, but a special circuit that is essentially digital.

Lynner: *Do the French people in any way feel that IRCAM is an excessive project? Do they feel like it possibly is going to relate to them?*

Risset: Oh, I didn't mention that Boulez wants IRCAM to be international in

nature. It cannot afford to be narrowly national, because there are just not enough resources in one country. There has to be a mass interaction of advanced people in the field. This is also one of the reasons why Boulez wanted the foundation; because eventually the support will not be all from the French government. Well, probably for a little while it will depend on the French government and—yeah, there are some problems. There are some people who feel that it is a monopoly and they are frustrated with it. I think I understand that quite well. I think one can also say that in general the effect of IRCAM has somewhat been to increase the general amount of money given to research. Since the project of IRCAM, there has been more systematic thinking about subsidizing other musical research institutes in France.

Lynner: *So there will be other musical research in France?*

Risset: Oh, very much so.

Lynner: *And they will receive government funding?*

Risset: Yes, yes, and of course, they may resent IRCAM because they find they are not as well treated financially, but I think the general momentum of the whole thing may be that there is a little more for other research as well. For example, there are several electronic music groups that have long been existing like the Groupe de Recherche Musicale (GRM) of the French radio, Bourg Electronic Music Center, Marseilles Electronic Music Center, and the center in Metz. And these groups are also financed by the government independently of IRCAM research. And I think there is, understandably, quite a lot of tension, and I think the way to relieve this is for IRCAM to be able to provide the tools that will be usable outside of IRCAM and then you will find that they are involved. I think also the public is expecting quite a lot in terms of manifestations and maybe they're expecting too much, because research in music is not always like the research on planes. There is some tension, but I'm glad to see also that there are some collaborations considered. For example, the GRM is getting a computer that will be compatible with ours, and we have to be sure that we do it this way so we can be exchanging information. Certainly no institution should be monopolistic. Sometimes it's good to have a different kind of sub-center. Max Mathews is working at Bell Labs, and there he can really be tuned to the latest material and understand in what way it can be used for music. I think that's very valuable, whereas perhaps there is not such an environment in IRCAM. If there is not a continued relation with those places where technology happens, it could stay there. And it shouldn't. ☉

Home Recording: Part Two

PRODUCTION TECHNIQUES

by Craig Anderton

In part one, we talked about the art of production on a general basis. Now, let's discuss specific techniques to use while mixing down and assembling a master tape. The process of mixing has taken on greater and greater importance in recent years, largely due to the "cut and paste" nature of modern multitrack recording. Mixing is not only a stage where several tracks blend together to form a two or four track master; it's a stage where modification and editing can take place. Some mixdown hardware options (such as reverberation) have been available for quite some time; other options (such as analog or digital delay lines) have only recently appeared on the scene. By taking full advantage of as many options as required in an intelligent and tasteful way, the overall sound of a piece may be strengthened, certain sections can be accented, and older tracks may be re-recorded. It is true that a good mix can make a piece; it is equally true that a bad mix can break it.

Common Mixing options:

Stereo Placement: Recording consoles typically have a *panpot* which allows an individual track to be placed anywhere in the stereo field (left, right, center, or anywhere in between). In popular music, foundation tracks like drums, bass, and lead vocals generally gravitate towards the center, whereas overdubs like harmony vocals and lead lines end up being more left or right of center. However, there are also creative ways to handle these basics. Drums may be miked and placed in stereo, so that as the drummer goes around the kit, sounds emanate from all parts of the stereo field. One particularly effective use of this technique involves changing the drums from mono to stereo placement while a piece is in progress. You may start off with both drum tracks placed in the center; then, during a break or section that accents the drums, you can spread out to the full stereo field.

Stereo placement can also help eliminate "fighting" between instruments. Let's say that after getting a beautiful stereo drum

sound you mix in the bass, only to find that the bass and bass drum mush together into one big, indistinct sound. In this case, try weighting the drums to one side and the bass to the other. Avoid sticking the drums and bass on extreme right or left, though; it can be disconcerting to hear a disconnected rhythm section with one part chugging along in the right channel and another in the left.

Last issue we talked about the advantages of doubling an instrument or vocal (by doubling we mean playing a part, then overdubbing the exact same part on a separate track. The combination of these two tracks gives a thicker, more punchy sound). These two tracks may be mixed together into the same location for maximum thickness in the case of a lead line or solo. When the doubled part is used as accompaniment, it often sounds better to mix the doubled parts in opposite channels. This can "frame" lead parts that are mixed in the center.

Another aspect of stereo placement is "panning", or giving a signal right to left motion instead of sticking to a fixed location. When overused, panning can give a sense of disorientation and make a track overly busy. Panning is at its best when used sparingly and tastefully. For example, a single oscillator sweep panned from left to right imparts a feeling of motion that is just not possible with static placement. Figure 1 shows how to obtain the illusion of circular motion in stereo by adjusting the panning and level controls simultaneously.

Above all, use stereo placement wisely to create a balanced sound that is open and clear, without undue weight in either the left or right channels. Not all systems have perfect balance and separation; the closer you mix to mono, the better your odds of being heard as you intend to be heard.

Reverberation: Just as stereo placement gives a left-right spread, adding reverberation to a track can place an instrument in the foreground or background. It's important not to get carried away, though, as a little reverb goes a long way. Generally,

reverb is seldom used with low frequency sounds like bass and bass drum; try it sometime and you'll see why . . . you get a sort of booming rumble that destroys definition. Reverberation can, however, help soften lead lines, give an illusion of acoustical space, place background instruments truly in the background, and temper the dry, clinical sound that sometimes results from recording in acoustically dead and sound-proofed rooms.

Most reverb outputs can be switched or panned across the stereo field, which opens up many possibilities. Examples:

- You have a doubled vocal, and want the sound of spreading the two vocals into opposite channels. However, this leaves a bit of a hole in the center. By placing the vocal reverb in the center, you fill the hole without messing with the vocals.

- You have two instrumental parts in opposite channels that play back and forth to each other. Try putting reverb from the instrument in the left channel in the right channel, and reverb from the right channel instrument into the left channel. This helps to obtain maximum stereo separation while still maintaining a balanced overall sound.

Remember that in most cases you want to add some ambience, not a sound that's distinctly obvious as "reverb". Unless being used for a specific effect, if the reverb is really obvious then you are probably using too much.

Equalization: During mixdown, you will often note that a certain instrument is either too prominent, too buried, or in some other way unsatisfactory when blended with other tracks (although it may sound just fine by itself). Here is where equalization can really save your tape. Lack of presence in a guitar, for example, can be easily corrected by adding a degree of midrange boost. Vocals can be made more prominent with a little bit of a peak around 1.5 to 2.5 KHz. An overly booming bass may be trimmed by selectively cutting back the bottom end and adding a bit of treble . . . and so on.

However, there are some pitfalls. If over-

please turn the page

Production Techniques

from page 33

used, equalization can give an artificial sound, making instruments far brighter or peakier than they are in real life. While this may sound great at first listening, the novelty can wear off after repeated listenings. Just like reverb, a little bit goes a long way . . . don't necessarily use equalization for the sake of effect, but rather to create a more balanced and satisfying sound. You can't cover up weak tracks with polish and gloss, and you'll only get frustrated trying.

Before going into special effects, there are a few general points worth mentioning. When the mixdown process begins, listen to the tracks "dry"—without any modifications—before adding any changes. Listen critically to any glitches that crop up (i.e. lack of presence, over-prominence, unbalanced frequency response) and correct each problem one at a time. Hopefully everything will sound great; but chances are there will be something you didn't anticipate correctly while recording, and here is the time to do something about it.

Also remember that any change you make to one instrument will alter its relationship to the other instruments, and to the piece as a whole. For example, let's say that upon listening you feel a bass drum doesn't have enough oomph . . . so you add a little bass boost. This then causes interference with the bass, which is in the same frequency range; so, you add some treble to the bass and peel off some of the low end to make room for the newly accented bass drum . . . except the added treble on the bass interferes with the low end of the guitar . . . and so on. Make your changes carefully and sparingly; your reward will be a more uncluttered sound.

Special effects: Any effects used while recording (like phase shifting, echo, delay, and so on) may be applied during the mixdown process. In one instance I was recording a guitar track before the character of the entire piece was obvious. As the piece went on, the overall sound became more diffuse . . . and the original guitar part sounded so normal it stuck out in an overly obvious manner. Adding some phase shifting during mixdown softened the guitar, and a little reverb placed it far back enough in the track so that it fit in much better with the piece as a whole.

One of the most versatile and useful special effects to grace the modern studio is the delay line. It can add reverb, echo, vibrato, or strange mechanical sounds; and can be very helpful during mixdown. Imagine taking an acoustic piano track and adding vibrato to certain sections . . . or using delay to double an instrument without

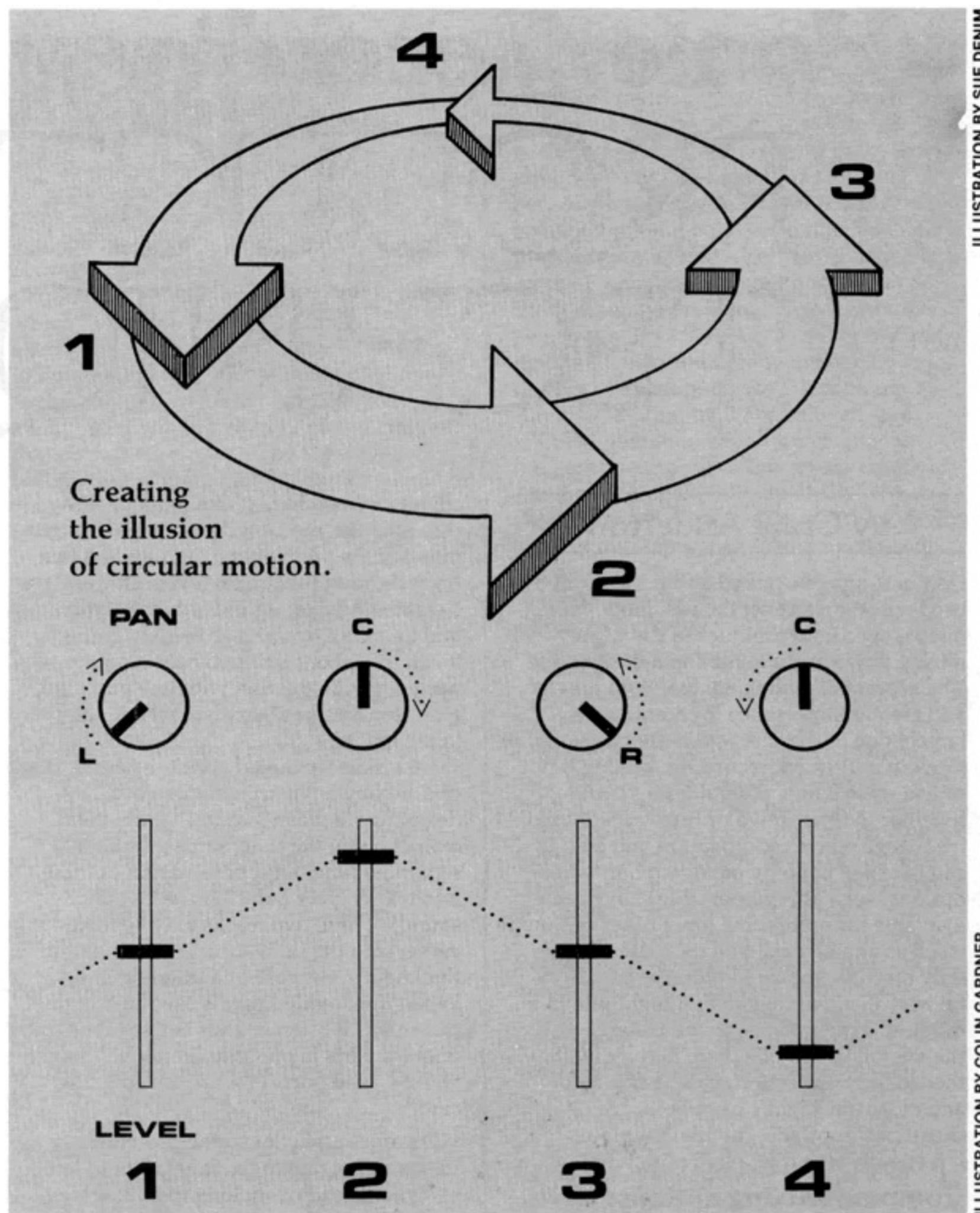

having to use up another track for an overdub. The point is, there are many signal processing devices available, and they are equally applicable to mixdown as to basic tracks. When mixing, if something just doesn't sound "right" but the actual part is fine, chances are there is something you can add that will help out. Again, the same cautions about restraint apply.

Additional overdubs: Sometimes, a piece will change so radically during the recording process that the first few tracks that were laid down sound out of context. In these cases no amount of modification will help—it's best to just re-cut the offending tracks in light of the new shape the piece has taken.

Editing while mixing: While mixing, you can fade instruments in or mix them out where appropriate. When I record solo in the studio; for example, I usually start off with a drum track to set the tempo. However, I rarely want to start a piece with just drums; so during mixdown, I leave the drums out

until an appropriate entrance point.

So far, we've talked about modifications that can happen to a particular piece of music in the creation of a desired sonic goal. However, many times a piece of music will be part of a larger work or collection of works. Part of the role of a producer is to combine the various parts of a longer piece together for the best possible effect . . . it helps to give the music a sense of continuity.

For instance, it helps to record more material than you need. If you're aiming for a 40 minute album, then cut an hour's worth of stuff. That way you can pick and choose the very best material, and throw out anything that doesn't quite fit in.

Once you have chosen these pieces, carefully consider how you want to pace them. There are certain formulas in the record biz for pacing, such as put your best number first, your next best last, and your weakest cut next to last. However, this is mostly a commercial restraint, and you really need

ILLUSTRATION BY SUE DENIM

ILLUSTRATION BY COLIN GARDNER

to find your own optimum order. I know one band that starts their tapes at a very low level, which almost forces the listener to pay attention . . . then, they build into something much stronger once they have the listener's attention. The crux of the problem is to preserve overall continuity while giving as much variety as possible within the chosen framework. Try alternating slower pieces, faster pieces, those that end on fadeouts and those that end abruptly. Try to mix up your key signatures—four numbers in a row that are all in the key of A can get boring, even though each individual song may be excellent.

Another matter that needs attention is the space or transition between pieces. You'll probably want more of a space between very dissimilar songs; other pieces may naturally go right into each other, in which case you can splice them together tightly. In one classical guitar album I worked on, we had a situation where a very light, untempo composition was followed by a suitably somber rendition of Musorgsky's "The Old Castle"; the transition was just too sudden, and the listener had no chance to acclimate to the sudden change. The answer was to stick in a small supplementary transition between the two pieces to bridge the gap. In this case, we used a backwards autoharp; the effect was unusual and riveted the listener's attention. The last few notes of the autoharp had heavy tape echo added, which cross faded into the beginning of "The Old Castle". In similar situations, try to construct connecting sonic bridges between dissimilar pieces and you'll have much greater continuity.

There's more to cover, but only a limited amount of space. If this kind of thing interests you, check out my book "Home Recording for Musicians" which delves into these subjects in greater detail. Remember that production shouldn't be obvious or gimmicked; it should naturally emphasize whatever is happening on the tape by drawing attention to the strong points and minimizing the weaknesses.

Although I've tried in this part of the series to be as specific as possible, every situation is different, every studio is different, and everybody's selection of equipment is different. The only way to become really proficient at production is to do as much of it as possible; gather a repertoire of techniques and tricks. The more you gather, the more flexibility you will have in dealing with particular situations. Be as critical as possible while mixing and assembling—look on your music as highly imperfect; don't settle for anything but the desired result. If a part drags a little bit, work on something to pick it up. If a piece peaks too soon, work on that. Don't be so in love with your music that you lose your objectivity—that is the most important part of being a good producer. ●

Copyright © 1978 by Craig Anderton. All rights reserved.



Good news from EML
SPECIAL PRICES
 Get more for your money. For a limited time we've reduced our prices on the board.
POLY-BOX
 Now add 26 additional pitch sources and a unique polyphonic capability to your synthesizer. Adapts to most synthesizers.
KITS FOR SYSTEM DESIGNERS
 Do it your way. Design a system that fulfills your own creative requirements. Complete instructions for special applications available.

Write or call today. **NOW CALL TOLL FREE 1-800-243-7270**

EML electronic music laboratories, inc. makers of ElectroComp Synthesizers
 P.O. Box H, Vernon, CT 06066 • (203) 875-0751

FOR A GREAT AUDIO ADVENTURE

A new, exciting discovery in great sound awaits you in **THE AUDIO AMATEUR MAGAZINE**.

It's delightfully easy to improve, maintain, and even build your own audio components. Thorough articles—everything from amps to speakers, simple add-ons or improvements to intricate modifications—help even our non-technical readers develop superior sound equipment.

Subscribe now on a guaranteed satisfaction basis or send for our **FREE prospectus**.

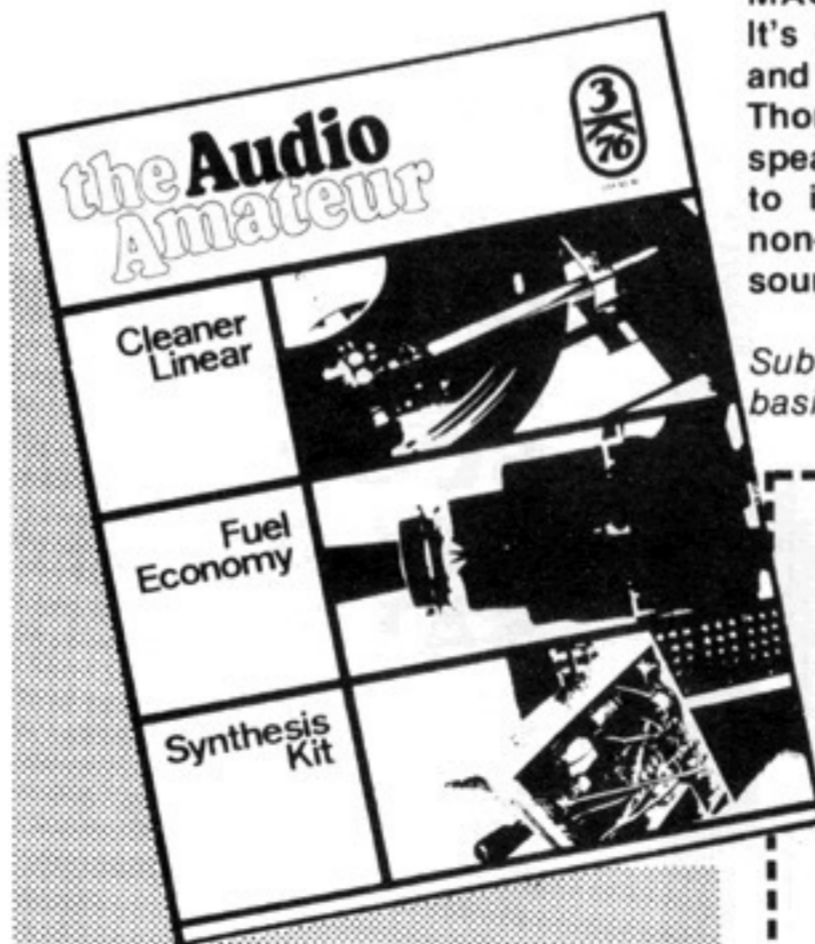

HANDY COUPON

Fill in the coupon, include a check or money order payable to *The Audio Amateur* and send to TAA Dept. S1, Box 176, Peterborough NH 03458 USA.

- Enter my sub for TAA for one year/four issues for \$9.
- I want to know more. I enclose \$2.50 plus .50 cents postage for the current issue of *The Audio Amateur*.
- Send free prospectus.

Name _____
 Street _____
 City _____ State _____ ZIP _____

Foreign subscriptions are \$10 per year and all remittances must be in US funds.

HOENIG

from page 25

anyone who looks at my pieces from a strictly musical standpoint can see very easily that there are in each piece more or less strict principles and relationships in the melodic and rhythmic structures. I also added richness by playing separate sound colors in unison. I am searching for sounds that are inbetween instrumental sound colors that are already known, where there aren't already existing associations, or pre-determined moods.

Synapse: *I am curious to know some of the basic technical procedures used on the album. For instance, anything like the use of a click track on the tape recorder, so that you can re-align all of the sequences; or the use of the sequencers free running with each other to cause phasing.*

Hoening: There was a basic click track on the 8-track, but because I played most things by hand, I didn't use it too often; but it was always there if it was needed.

Synapse: *Were you using divisions of that pulse for different rhythmic situations?*

Hoening: Yes, the pulse was faster than the sequence itself. For instance, the piece 'Hanging Garden Transfer' builds up the rhythm in the beginning, and in the end falls apart. In that piece, it was very

important that I had the click track faster than its perceived rate at the beginning of the piece.

Synapse: *Are there any other aspects of the way that you were using the synthesizer or the sequencer that you think would be of particular interest to our readers?*

Hoening: I think there is nothing technically new to any synthesizer player on the album. I think everybody who's into synthesizers knows it. The basic structures are so simple that they do not require extremely complex patching.

Synapse: *Could the music on the album be performed live?*

Hoening: Yes.

Synapse: *Will you be doing any touring?*

Hoening: I haven't made up my mind yet. I know that there is a big demand by American audiences to see live performances, and live performance has a much bigger value in the States than in Europe. I won't do concerts unless I can perform in places and venues that are not strictly limited to rock audiences. I'll never perform clubs and that sort of scene. I would limit myself strictly to a good listening audience in places like greenhouses, planetariums, and concert halls, not using any visuals. Places where people really listen. That, of course, requires a basic audience to make it happen, and it costs a lot of money to tour the United

States. So, if the support was there, it would be possible to perform the music using three or four other synthesizer and keyboard players.

Synapse: *What do you feel, for your own music, would be useful to have designed?*

Hoening: What I want are sound colors that don't have definite relationships in one's mind yet. I want, for instance, a soft blown sound, but it shouldn't be precisely a flute; it should be between a flute and an oboe. That's one very important step. So, what I certainly need in the not too distant future, is digital sound equipment, such as is being developed by John Chowning, IRCAM, or Hal Ellis at Bell Laboratories. Unfortunately, all these machines I've seen so far are not usable from the interface side. First, they don't have enough software yet. On the other hand, they are so obviously built by engineers, and not by people who use them as instruments. Another example is all of those digital sequencers they have out now, such as the Sequential Circuits, and the Oberheim sequencers. They are completely uninteresting for me, because when I have a sequence, I am not at all interested in letting the sequence run. I want the sequence to be played with. I want access to all steps, whether it be pitches, the sound color, or whatever. I want access. ©

Synapse

sound advice
programming



entropy west
electronics

REALTIME ELECTRONIC
MUSIC

1242 HARVARD ST.,
SANTA MONICA
CALIFORNIA 90404
(213) 828-0389



**ELECTRONIC MUSIC:
IN-HOUSE PRODUCTION
SCORING/ARRANGING
RECORDING • RENTAL
SALES • CONSULTATION
INSTRUCTION • 2825
HYANS ST. LOS ANGELES
90026 • (213) 487-5148**

Sound Arts

patch notation

a business approach

by Richard Bugg

It attempting to maintain some semblance of reality in notation of synthesizer patches, it soon becomes apparent that if there is no method to the madness, the former will be lost to the latter. Some form of permanent, or at least semi-permanent, recording of information is needed to allow the reconstruction of a specific sound. This would also make it possible to communicate the construction of that sound to some other person, removed by space or time. It would allow them to duplicate that specific sound by something more than trial and error.

Some systems of notation have been proposed and are in limited use. As of yet no simple "universal" notational scheme has been adopted by a majority of synthesists. Examining two of the more well known systems will provide a look at what is currently being used.

Probably the most familiar notation system to the owners of small systems like the Minimoog and the Odyssey is the "FRONT PANEL FACSIMILE" system. The advantages of this system are clear. For the user of the small synthesizer there is a direct correlation between the notation and the controls of the instrument. The disadvantages are realized as one either moves up in type or size of instrument or attempts to communicate with other persons on the subject.

Even on instruments of the same type, there are small variations in settings. One example is in attempting to locate the exact

point at which the resonance knob causes a low-pass filter to break into oscillation. Translating the patch from one instrument to another type of instrument is also difficult. Trying to find the ring-modulator slider on a Minimoog or the inverted envelope generator input on an Odyssey can be frustrating.

The final problem of the "FRONT PANEL FACSIMILE" system is the size versus speed. The larger the instrument becomes, the more details are included in the notation. More data has to be checked, even for a simple patch, to be positive that everything has been set that needs to be set.

Another form of notation involves a more abstract and therefore perhaps more adaptable form. Instead of a facsimile of the instrument, a symbol is chosen to represent each module. Only those modules used in the patch are drawn in. This enables a simplification of the notation. Interconnection between modules becomes apparent with a few simple rules. One example is when signals start at the top left, output is at the top right, and processing is in between.

This at first seems like a workable universal notation. In many respects it has overcome the problems of facsimile representation. The disadvantages of this system lie in the fact that it is based on modules. Several operations may be performed in one module on one type of instrument. The same operations may be in several modules or non-existent on a different type of instrument. The system requires a large number of symbols and abbreviations as well as

a coding of interconnections which is anything but simple. It might seem as if there is no hope of electro-music-kind ever being able to express itself and notate for future generations with any comprehension. But wait, now that we know a few of the things we can live without in a notational system, let us take a moment to define what it is we wish to do. Notational systems serve two needs:

- (A) To assist the mind in exactly recreating an event.
- (B) To assist communication with other persons not in our presence.

It is due to the need for exactly recreating an event that a precise notational system is needed. But how precise? During live performances only so much information can be assimilated before time dictates action. Unless the data is arranged in such a manner as to convey information efficiently, there will be insufficient time to absorb everything necessary to realize a complex patch. If a system is capable of being brief enough for live performance, can it also serve to communicate all the necessary information for complete realization? Where does this leave us? In order to develop a simple, precise, and also flexible notational system, let us consider exactly what is needed.

- (1) All symbols should be easily recognized.
- (2) All symbols should be simple enough to be drawn in "free hand". (In the rush to save a new patch one should not have to reach for the protractor, French curves, templates, etc.)
- (3) Notation should retain above values

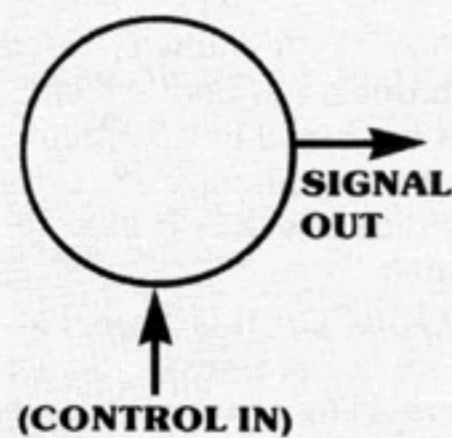

Figure 1.

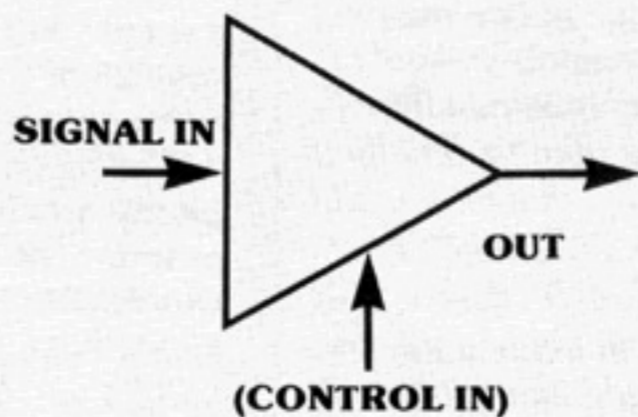

Figure 2a.

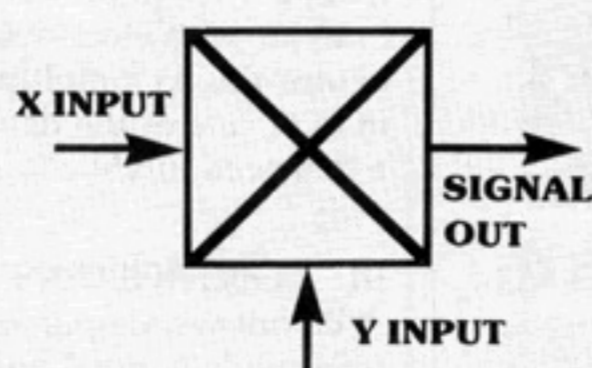

Figure 2b.

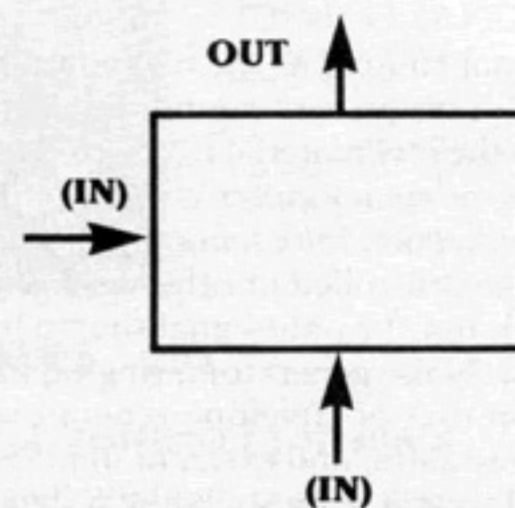

Figure 3.

ILLUSTRATION BY SUE DENIM

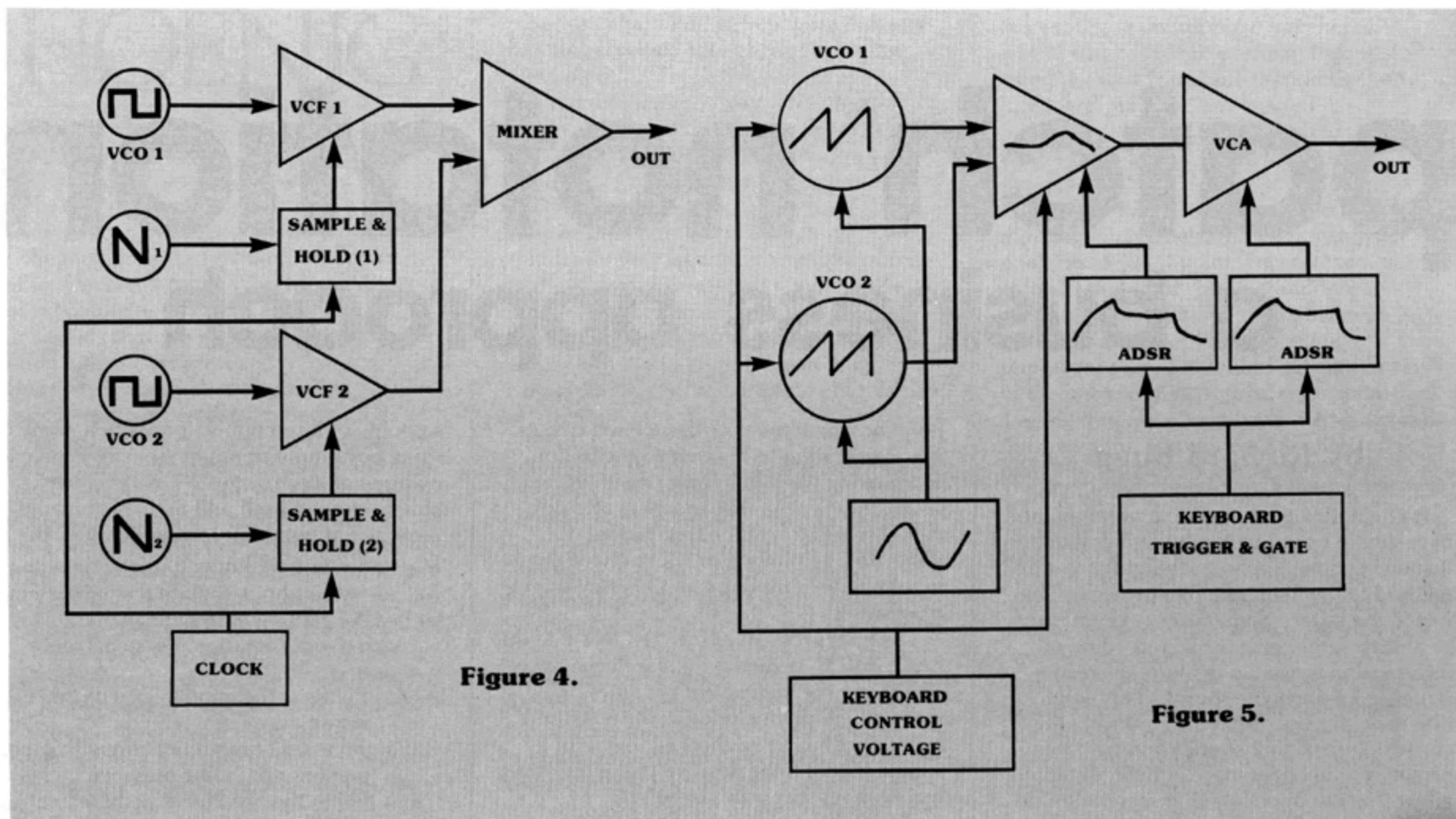

Figure 4.

Figure 5.

ILLUSTRATION BY SUE DENIM

from page 37

when reproduced monochromatically. (Colored pens and pencils are not always at hand.)

How do we shape these concepts into reality? Consider the instrument—the synthesizer. Analog systems can be broken down into three classes of devices. Each has a specific function. Though a module may contain functions from several different classes, it could easily be divided in notation into sections. Each section of the module would belong to a specific class. If we examine what is happening in a synthesis system, we can break it down into three parts:

- (1) Signal Sources
- (2) Modifiers
- (3) Controllers

Let us take a look at each part briefly to see what we have.

I. SIGNAL SOURCES

A signal source, as the name implies, is a point of origin for a sound. In a synthesizer this is the raw material from which to work. The basic signal source common to all synthesizers is the oscillator. It can be voltage controlled or otherwise. The oscillator is not the only signal source to be found. Noise generators, ringing filters, certain uses of envelope generator outputs, slew modules, and external signals can be a signal source. Any source of a signal, the point at which that signal originates, is a signal source. The symbol for this class is a circle.

II. MODIFIERS

A modifier is a device which in some way, shape or form modifies a signal or group of signals. The first device which one may think of as a modifier is the filter. It is one which is capable of a radical change in a signal. But filters are far from being alone as a modifier. A mix-pot or fader is a very simple modifier. It changes the amplitude of a signal. Any device whose function is to alter a signal passing through it is a modifier. The symbol for this class is a triangle with one point in a horizontal position. (fig. 2a) This is derived from the schematic representation of an operational amplifier, a device from which a lot of modifiers can be realized. The one special case is the balanced (ring) modulator due to the fact that there are two inputs which modify each other. Each input to the device serves as both a signal to be modified and a signal controlling modification. The symbol for a balanced modulator is a square box with a multiplication symbol from corner to corner. (fig. 2b) Persons familiar with electronic symbols will recognize this as a multiplier, four quadrant in fact, one of the devices used to realize a balanced modulator.

III. CONTROLLERS

A circuit whose purpose in existence is to provide control voltages, or other forms of control in a patch, is a controller. Controllers span all the way from the most visible, the keyboard, to the use of devices not readily associated with the con-

cept of control. Any device used as a form of control is a controller. The notation for this class is a rectangular figure drawn around the controller type. (fig. 3)

Now that we have a fundamental system allowing us to notate the various building blocks of a patch, we need to discuss how to notate their interconnections. For creative synthesis a "signal", or group of moving electrons, should not be permanently segregated under any circumstances. In any patch there are "signals" which at some point in time are performing control function and "signals" that are being controlled. We have two groups of moving electrons. The only difference is in use. Some are controls, some are signals. Most writing surfaces are able to accommodate two axes. It is convenient to assign one axis to each group. Controls generally move from bottom to top. Signals generally flow from left to right.

Now let us examine some specific cases and how they are notated. Figure Four is a simple patch from the block diagram on page 28 of SYNAPSE, Volume 2, No. 2 as it appears in this notational system.

The patch is explained in the Electrophony article starting on page 28. Let us examine the choice of symbols used to express this patch.

1. SIGNAL SOURCES: It is clear that VCO 1 and 2 are signal sources. So are the noise generators. Why? Because they provide a raw signal which is processed by the sample and hold to extract, in this use, pseudo-random control voltages.

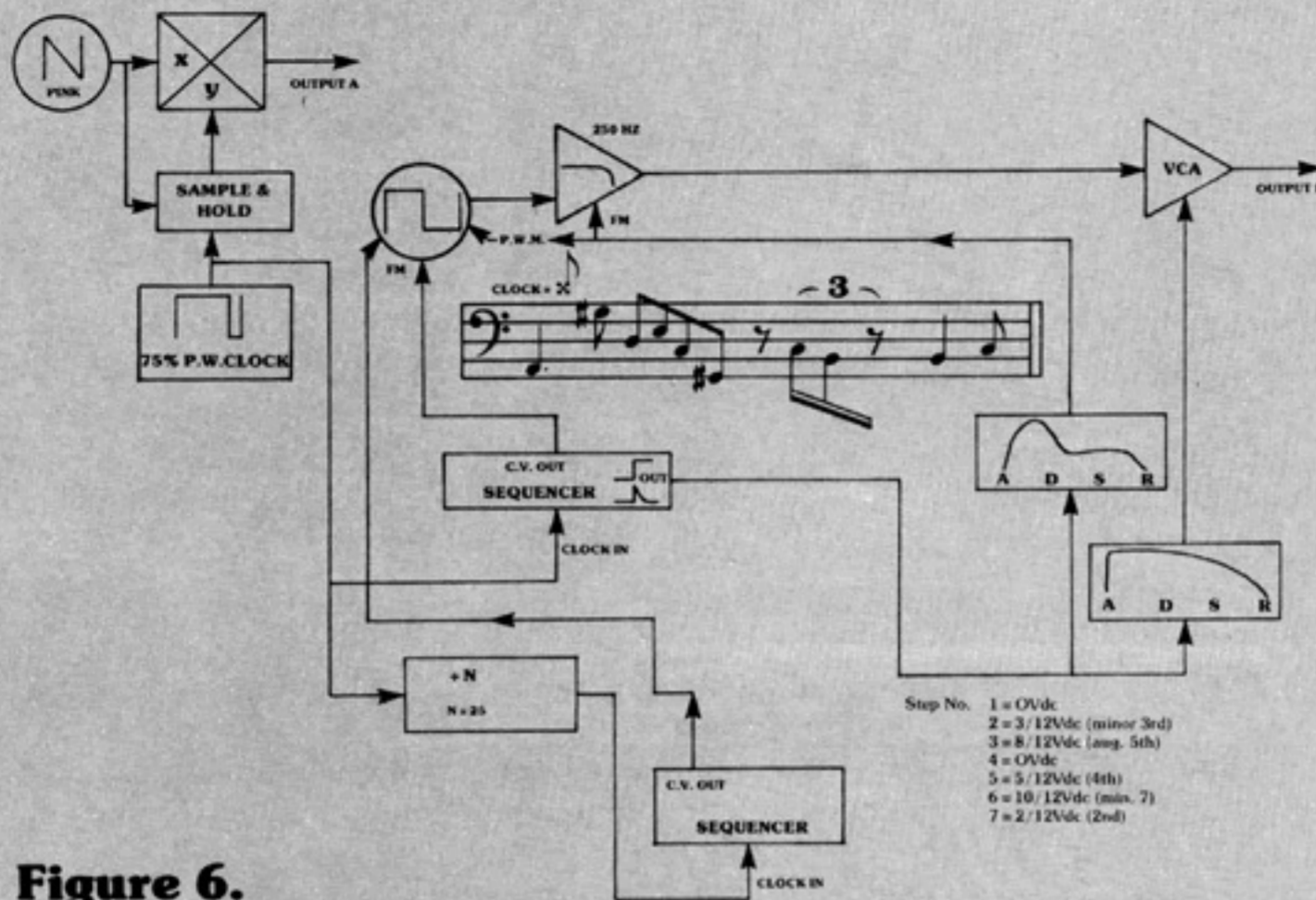

Figure 6.

*The Symbol +N defines a division circuit whose divisor is variable. In this case N = 25. For each 25 input pulses there will be 1 output pulse.

2. **MODIFIERS:** The VCF's 1 and 2 and the mixer are the modifiers here. The mixer qualifies because it is adding together two signals and produces an output consisting of the sum of the two input signals.

3. **CONTROLLERS:** The clock is controlling the sampling of the sample and hold modules. The sample and hold circuits are controlling the VCF's.

The sample and hold in this patch represents an example of one device performing two functions simultaneously. It is controlling the VCF's, but it is doing so with a signal which is essentially a greatly modified "noise". How do we determine

then how it should be notated? I have chosen to notate it as a controller because its function in this patch is to provide a pseudo-random signal to CONTROL the VCF's. If you substituted a noise generator with a slow random output for the combination noise generator-sample and hold module, it would be notated as a controller. This would of course change the effect of the patch.

Let us now look at what has become perhaps overused as a synthesizer performance patch on the ARP 2500 and the Minimoog.

Figure 5 shows the patch in notation.

A simple enough setup is two VCO's being controlled by the keyboard control voltage. A common oscillator using a sine wave to freq. mod. (vibrato) is utilized. The sawtooth (or ramp) outputs are mixed together. Then they are run through a VCF set up as a low-pass with a moderate resonance at the cut-off point. The cut-off point is the hump at the start of the slope. The filter is being controlled by the keyboard control voltage to track the signal and is also being controlled by an envelope generator. The envelope generator is in turn being controlled by the gate and trigger signals from the keyboard. The output of the VCF is then further modified by the VCA. The VCA is being controlled by another envelope (transient) generator which is in turn being controlled by the gate and trigger signals from the keyboard.

Last but not least is an excerpt (Figure 6) from one of the author's compositions. If I have explained this system properly, you should be able to more than figure it out. Have fun.

I hope the explanations have been clear enough to demonstrate the versatility and simplicity of this notation scheme. The amount of detail, or lack of it, is up to the calligrapher. Once the skeleton is sketched out, there is often sufficient information for an experienced synthesist to reconstruct the missing data. This system has been used by myself in the present form for the past two years. Though I have a long way to go before experiencing more than a small portion of synthesis, I have not as of yet run into a situation that could not be dealt with by using the preceding guidelines.

I cannot speak for where I may have gathered information for the project subconsciously. Development of this notational system rests firmly on the background work done by Jim Mitchmerhuizen, Beaver and Krause, Tonus, and encouragement from John Simonton, Jr. ©

ILLUSTRATION BY SUE DENIM

Synapse

Advertisers' Index

Aries Music, Inc. 11	Electronic Music Studios (London) 21
Sam Ash Music Stores 31	Entropy West Electronics 36
Audio Amateur Magazine 35	Patrick Gleeson 32
Boston School of Electronic Music 32	RMI 31
CFR Associates 31	Korg/Unicord 5
Cincinnati Independent Electronic Music Studios 31	PAIA Electronics, Inc. 40
Dennis Electronics 39	Ken Schaffer Group . . Front Inside Cover
Di Marzio Musical Instrument Pickups, Inc. Back Cover	Sequential Circuits 6
Drum Drops 26	Serge Modular Music 14
Electronic Music Laboratories, Inc. 35	Sound Arts 36
	Sound Sales 13
	Warner Bros. Records 9

EXPAND YOUR SYNTHESIZER!



- 13 Modules in 1:**
- 2 Attenuators
 - 2 Slew Limiters
 - 2 Inverters
 - 2 Comparators
 - 2 Level Shifters
 - Mixer
 - F.W. Rectifier
 - Schmitt Trigger

DENNIS 201

Control Voltage Processor

ORDER NOW at this special price! With power supply and mahogany cabinet: Only \$299.00.

Dennis Electronic Music Co.
2130 Metcalf St. Honolulu, HI 96822

String Synthesizers Can Be: Just strings...

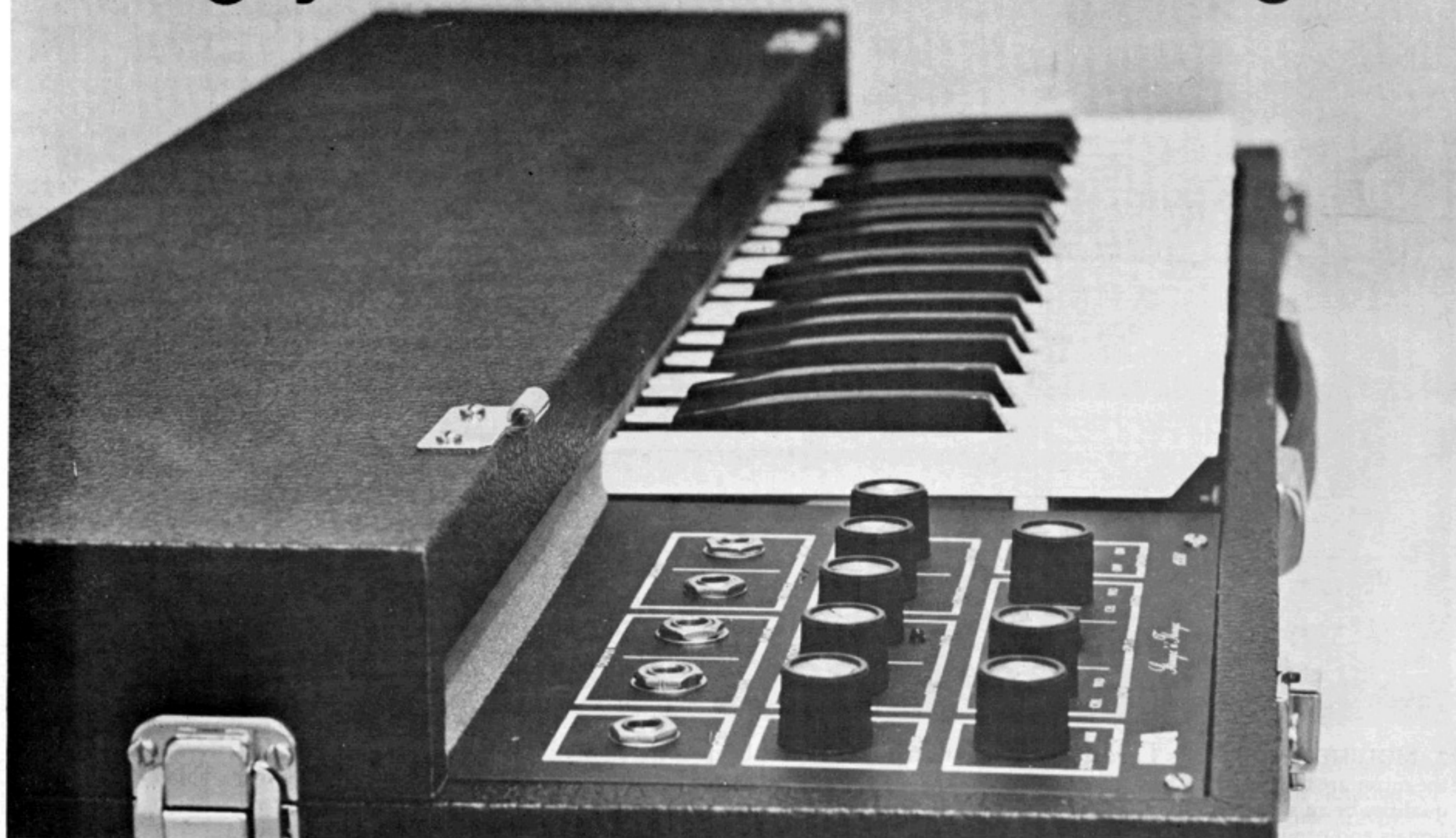

.... **OR they can have:** violins/cello/piano, separate mixable piano output, synthesizer interface, variable chorusing, variable sustain controls, jacks for foot controls, keyboard split, dual violin/cello mixers, stereo string option, even a modestly priced computer interface option.

You're gonna love it!

Stringz 'n' Thingz just \$295 from **PAIA**

TELL ME MORE

Send FREE CATALOG featuring this and other PAIA Kits.

Send Assembly and Using Manual for
STRINGZ 'N' THINGZ (\$5.00 enclosed)

name: _____

You've said enough, send complete kit for
STRINGZ 'N' THINGZ (\$295.00 enclosed)

address: _____

-shipped freight collect-

city: _____ state: _____ zip: _____

PAIA
ELECTRONICS

DEPT. 2-S, 1020 W. Wilshire Blvd., Oklahoma City, OK 73116 (405) 843-9626



COMPUTERS

DIGITAL DELAY LINES

We have finally covered all the important facets of Analog to Digital conversion. As a summary article on the subject, let's analyze a familiar piece of equipment which makes extensive use of Analog-to-Digital and Digital-to-Analog techniques. The device is a digital delay line, sometimes called digital echo. Even though the digital delay line is not a computer itself, many of the same Analog-to-Digital conversion principles apply.

A digital delay line takes an incoming analog signal, samples it and converts the sample into a digital word. The digital word is stored in memory for a predetermined length of time (delay time) before it passes it along to the output D/A converter where it is converted back to an analog signal. By mixing the delayed signal in with the undelayed original signal the effect of an echo is achieved.

There are counterparts to the digital delay line which do the delay in the analog domain. The three most common are the analog delay line (bucket brigade), the spring reverb and the coax cable delay line. Each of these has distinct drawbacks. The bucket brigade is the newest type of analog delay line. It is a single integrated circuit which works in a way very similar to the digital delay line except that the signal remains analog through the delay process. The bucket is actually an analog shift register which contains a string of 1024 "buckets" to store voltages. The buckets are no more than capacitors which store the charge. The string is arranged in a series so each time the analog input is sampled all the buckets shift their voltage to the next bucket down the line. This leaves the first bucket free to accept the new data and pushes the voltage in the last bucket to the output. The delay from the beginning of the string to the output is equal to the number of buckets in the string times the shift (sample) rate. The drawback of the bucket brigade is

that at each shift the analog voltage is altered slightly because of charge loss. The result is distortion and loss of signal level which causes a degraded signal-to-noise ratio.

The spring reverb converts the electrical signal to mechanical motion and then transmits it through a spring to a receiver at the other end which reconverts it to an electrical signal to be mixed with the original signal. The time the vibrations take to travel from one end of the spring to the other is the delay time. The spring adds coloration to the sound because of its uneven frequency response caused by mechanical resonances. The spring also is sensitive to other motion influences such as heavy footsteps or rock groups playing surf music and would transmit them to the receiver to be added into the original signal.

The final analog delay line, the coax cable, has its drawbacks too. This delay line takes into account the fact that electrical signals travel down cable at some finite speed. If a signal is passed down two cables of different length then the signal will reach the end of the longer cable later than the shorter one. This sounds fine until one realizes that to make an audible time difference in arrival times one needs several hundred feet of cable. In addition, the losses in the coax cable make for a significant degradation in the signal-to-noise ratio of the delay signal.

Having revealed the problems with the three popular analog delay lines you may expect that the digital delay line is going to fix everything. Well, it goes a long way towards the perfect delay but it still has some shortcomings. Let's look at a digital delay system and consider some of its limitations and trade-offs. A block diagram of a typical digital delay line is shown in Figure 1.

The frequency range which can be passed through the delay line is

turn to next page

Back issues are available!



Volume 1 Number 5
Interviews with Pat Gleeson and Gary Wright
\$1.75

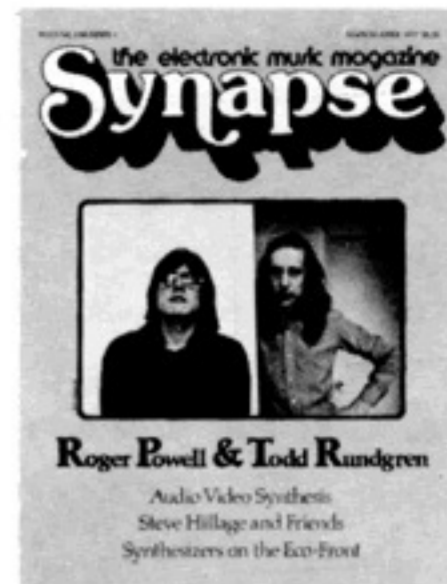

Volume 1 Number 6
Roger Powell & Todd Rundgren, Synthesizers on the Eco-Front
\$1.50



Volume 2 Number 3
Tomita, Stockhausen, Home Recording, Guitar Synthesis
\$1.50



Volume 2 Number 4
Jan Hammer, Stockhausen Part 2, Timo Laine, Home Production
\$1.50

The following issues are sold out:

- 1:1** Interview with Alan R. Pearlman of ARP **SOLD OUT!**
- 1:2** Interview with Morton Subotnick **SOLD OUT!**
- 1:3** Kraftwerk, Tom Oberheim of Oberheim Electronics **SOLD OUT!**
- 1:4** Malcom Cecil & TONTO, Bob Easton/360 Systems **SOLD OUT!**
- 2:1** Robert Moog, Herbie Hancock, George Duke **SOLD OUT!**
- 2:2** Tangerine Dream, Bernie Krause, Synthesized Video **SOLD OUT!**

Get 'em while we got 'em!

Quantities limited.

Add 50¢ postage and handling for each copy ordered.

Synapse Back Issues

2829 Hyans Street Los Angeles, CA 90026

Readers interested in obtaining copies of sold out issues should send postcard requests for our files. When we have enough requests, reprints will be made.

DIGITAL DELAY LINES

from page 41

directly related to the sampling rate. From previous articles, we know the sample rate must be at least twice as high in frequency as the signal being sampled. To insure this is true, the input signal is first fed through a low pass filter with a cut-off frequency less than half of the sampling frequency. Since the filter is not an ideal filter and will have some cutoff slope (see Figure 2), the sampling rate is usually about 2.5 to 3 times the cutoff frequency. Let's set the upper frequency at 16 KHz and use a sampling increase rate of 2.5. That makes the sampling rate 40 KHz.

Now that we know the sampling rate, we can calculate how much memory (how many memory storage words) is needed for a specific delay time. The digital data words will be coming to the memory at the sampling rate frequency of 40 KHz. There must be enough storage locations to take in the samples at the rate of 40,000 per second and store them for the delay time before they leave the output and go to the D/A

converter. The formula for calculating the memory size is as follows: the number of memory locations = sampling frequency X the delay. Most digital delay lines have a maximum delay of between 0.3 and 0.5 seconds. From the formula a 0.4 second delay would require 16 thousand words of memory. The technology for digital delay lines has been around for many years; however they were not economically feasible because of the high cost for such a large memory. Recent breakthroughs in solid state memory technology have caused the cost to come down dramatically while the memory density has gone up.

The length of the delay can be varied by controlling the effective size of the memory. The effective memory size is controlled by an address counter. The address counter points to a memory location which is either being written into from the A/D converter or read out of by the D/A converter. The address counter starts at address zero and counts sequentially up to the maximum address. When the maximum address is reached, the address counter is reset to address zero and the counting starts over again. One can think of the address counter as counting in an endless circle. The sequence of operations at each address is as fol-

lows: first the old (delayed) information which was in the memory location is read out by the D/A converter, then newly sampled data from the A/D converter is written in. After these two operations, the address is changed by one and the process is repeated. Varying the size of the address loop changes the length of time it takes to get back to a particular memory location, read the delayed data, and write new data. The delay between writing new data, going around the loop, and then reading it is: the number of memory locations X the time it takes for one sample. The sample rate is 40 KHz so the time for each sample is 25 microseconds (μsec). The delay for a 1000 memory location loop is: $25 \mu\text{sec} \times 1000 = 25 \text{ milliseconds (msec)}$. Increase the number of addresses to 2000 and the delay time is 50 msec.

So far, memory words have been discussed without reference to how many bits are in each word. The number of bits in a word is dependent on the resolution required in the A/D and D/A converters. The resolution affects signal-to-noise ratio and distortion. Each sample of the analog data is quantized into a digital number. The uncertainty of not knowing exactly where the analog voltage is between two consecutive digital

numbers, is considered to be noise. The signal-to-noise ratio comes when the signal is at its highest possible value. This value would correspond to the maximum binary number that can be stored in a memory storage location. The number of bits in the storage word determines its maximum number. Table I shows different signal-to-noise ratios of varying numbers of bits per word. Practically speaking, most digital delay lines use 12 or 14 bit digital words for reasons of cost and speed. 16 bit A/D converters are extremely expensive and are not usually fast enough to do the conversion at the required sampling rate.

Table 1: S/N ratio vs. bits / word.

Bits of Resolution	Signal to Noise Ratio
8	48db
10	60
12	72
14	84
16	96

S/N Ratio = 20 Log 2^N. N = numbers of bits / word.

Distortion figures are calculated in the same way as signal-to-noise ratio. There is another factor which figures into distortion, and that is frequency. At low frequencies, there are many samples per cycle of the wave being sampled. For a

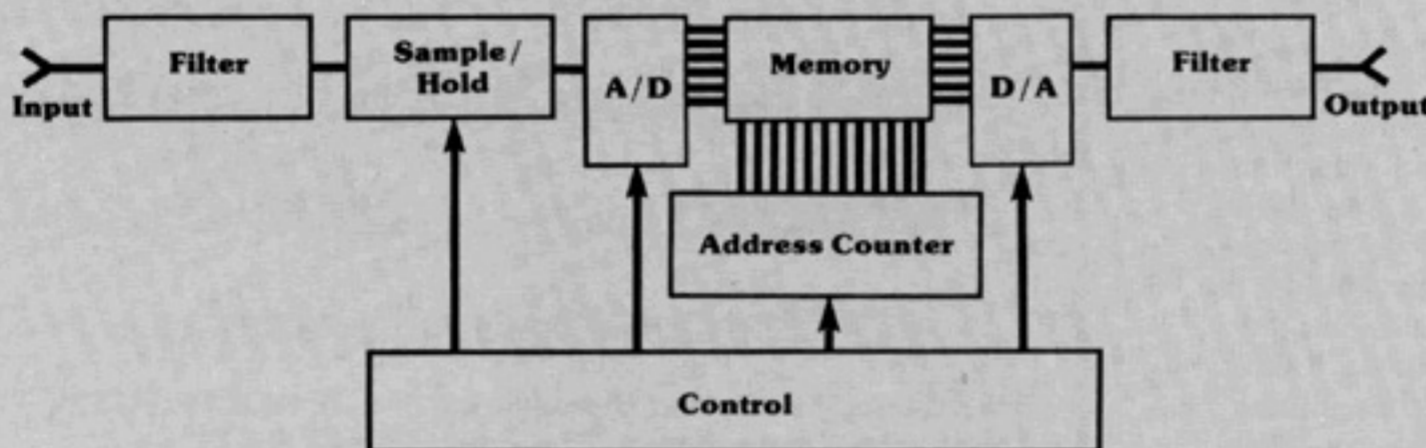

Figure 1: Digital delay line block diagram.

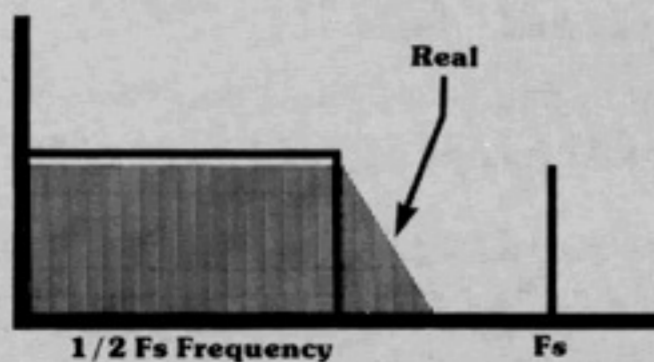

Figure 2: Ideal vs. real filter cutoff.

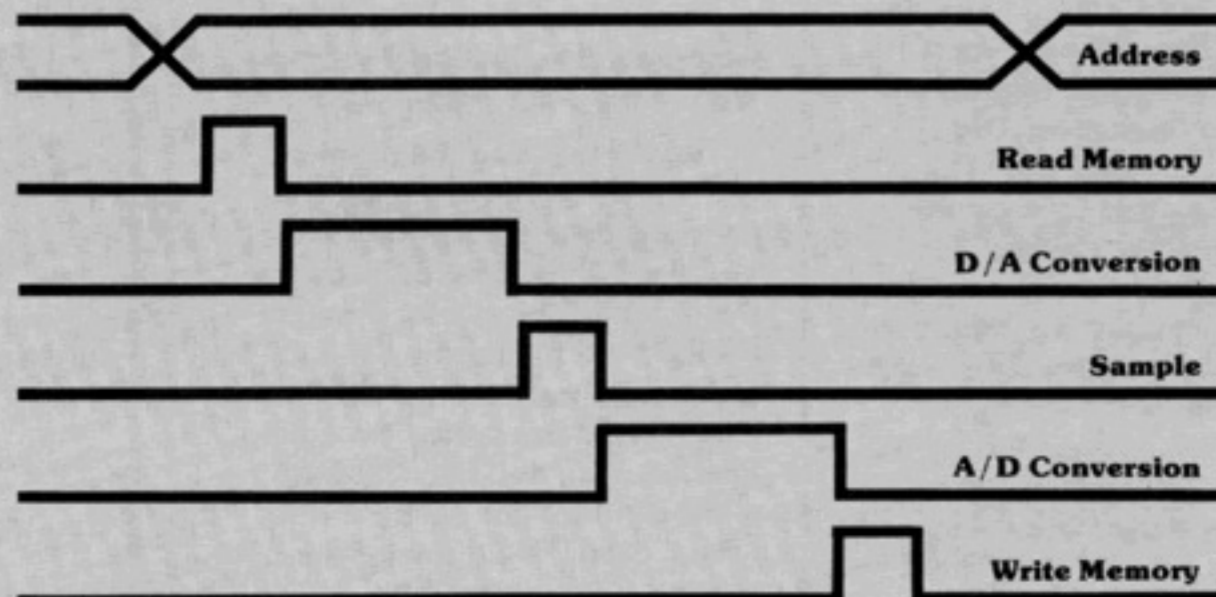

Figure 3: Timing diagram.

1000 Hz wave there are 40 samples per cycle with a 40 KHz sampling rate. However at a frequency of 10,000 Hz there are only 4 samples. Four samples of a sine wave would look like a disjointed staircase with very high distortion. This is not as big a problem as it may seem because the highest fundamental frequency of most musical instruments is much lower than 10,000 Hz. A guitar's highest fundamental frequency is about 1000 Hz, and a piano's is about 3600 Hz. The higher frequencies are usually harmonics of these fundamentals, and are of much lower amplitude; therefore they do not contribute much to the overall signal.

The Sample and Hold (S/H) follows the input filter and precedes the A/D converter. The job of the Sample and Hold is to quickly take a snapshot of the analog input and hold it for the A/D converter. The accuracy required of the S/H is dependent on how high a frequency it is sampling, the maximum amplitude of the signal, and the number of bits of resolution in the system. With the luxury of an S/H, the A/D converter does not have to convert at lightning fast speed. Instead, it can take the entire time between samples.

The A/D converter writes the digital word into the storage memory

and, after the delay period specified by the address loop, the data is read out and put into the D/A converter. In general, D/A converters are much faster than A/D converters so that it is not necessary to put an S/H on the output to keep it steady while the D/A is converting. The D/A converter might take 2% of the sampling period to change value, and then would be stable for the rest of the time.

A low pass filter is placed at the output of the D/A converter to smooth out any abrupt changes. The cutoff frequency of this filter is the same as that of the input filter.

The only remaining function in this digital delay line example is the controller. The controller is responsible for timing each of the other functions, such as making the S/H data stable before the A/D converter starts its conversion. Figure 3 shows a simplified timing diagram of the system operation. In most real systems some of these functions overlap.

—Peter Hillen

NOTE: In the last issue, there is an error in the sample and hold schematic. Pin 1 on the LM555 and the negative side of the 1 μ f capacitor should be connected to $-V$ instead of ground.

SYNTHESIS

Ambience: Part Two

Ambience, that spacious feeling that results from a displacement of time, can be colored in various ways by synthesizer processing. Using a delay or reverb chamber processed through the synthesizer, in conjunction with a mixer, is the most flexible way to patch the system together.

If you have a single synthesizer, try recording tracks dry and then processing the tracks through the synthesizer during mixdown (see Figure 1).

In the scheme of this patch, the Echo Send sends signals from both the playback recorder and synthesizer into the delay line. If you have an echo unit, set it to delay the input only once. The feedback loop

necessary for echo can be created through the synthesizer and the mixer. The amount of synthesizer recirculating back into the delay controls the amount of repetitions, and the amount of the synthesizer in the main output controls the mix of ambience relative to original signal.

If you don't have Echo Send, use either a cue (direct) output or one of the stereo outputs available on your mixer. On the other hand, if you have more than one Echo Send try hooking up the synthesizer to its own Send and then mixing things together on the console. Try exchanging the places of echo and the synthesizer in the patch as well.

turn to next page

TECH NOTES

Pitch Drift in Keyboard Synthesizers

Pitch drift, of increasing concern to music synthesists, can be due to a number of factors. Often it is due to dirt or corrosion on the keyboard's key contacts and can be cured with a cotton swab and ordinary rubbing alcohol. This sort of pitch drift is characterized as warble. Dirt cannot cause a steady drift downward or upward in pitch. A good way of detecting this warble is by holding the highest key down and sequentially depressing each lower key. In other words, the warble is most noticeable when changing directly from one pitch to another, uncluttered by a decay-attack event. In two voice synthesizers such as the ARP Odyssey this warble can be even more pronounced because two generations of pitch control voltages are being used—the second is derived electronically from both first and second keys, giving it a double dose of dirt. A good spot-cleaning of suspect keys will confirm dirt as the problem. The whole keyboard should then be cleaned.

Key contact timing is also very critical. Whether the keyboard uses two or three bus rods, spring or single wire contacts, the sequence of contact closure is probably important. One contact passes a control voltage which is the pitch information. A different contact may generate the trigger signal which will inform a sample/hold circuit that new pitch information is available. A gate signal may also be generated through the same or a different contact which discharges the sample/hold between key depressions. Obviously the timing of these events is critical to quick, reliable pitch change. Faulty timing could cause a kind of warble while playing the synthesizer. A close examination of the keyboard's contacts should disclose what sequence (or lack of it) is normal for your synthesizer and suspect notes can be compared to the norm. Adjustment is delicate but no special tools are required.

Should the synthesizer's pitch drift continuously upward or downward following a key depression, other mechanical problems may be indicated. A keyboard control voltage contact may have become lodged against or even popped over the wrong bus rod which is now supplying a constant potential to the sample/hold electronics. Such preemptive pitch information may correspond to a note above or below audibility, however, rather causing the unit to appear dead. Or perhaps a gate contact is lodged over a bus rod and the sample/hold is continually discharging, clearing its memory of the pitch it should be holding. A variety of symptoms could stem from other possible mislabeled contact problems. These symptoms are always more pronounced than a warble, however. Again, a close inspection of each key contact will verify such problems.

A short circuit or leaky component within the sample/hold electronics could cause symptoms similar to those of a mislabeled contact. If the keyboard inspection reveals no problems, a technician familiar with your synthesizer's circuitry should be consulted. Any very slow drift almost always eliminates the keyboard from suspicion. If the sample/hold circuit is working, the oscillators themselves become suspect: or perhaps there is faulty power supply regulation. Temperatures and temperature compensation are critical to pitch stability and could also be at the root of the problem.

Faulty calibration is almost never the cause of pitch drift. Calibration errors produce static symptoms such as uneven keyboard tuning, octave transpose (range) errors and poor tracking between oscillators. Calibrations should also be done by a technician who is familiar with the unit and well equipped with accurate digital test equipment.

—Richard Diemer

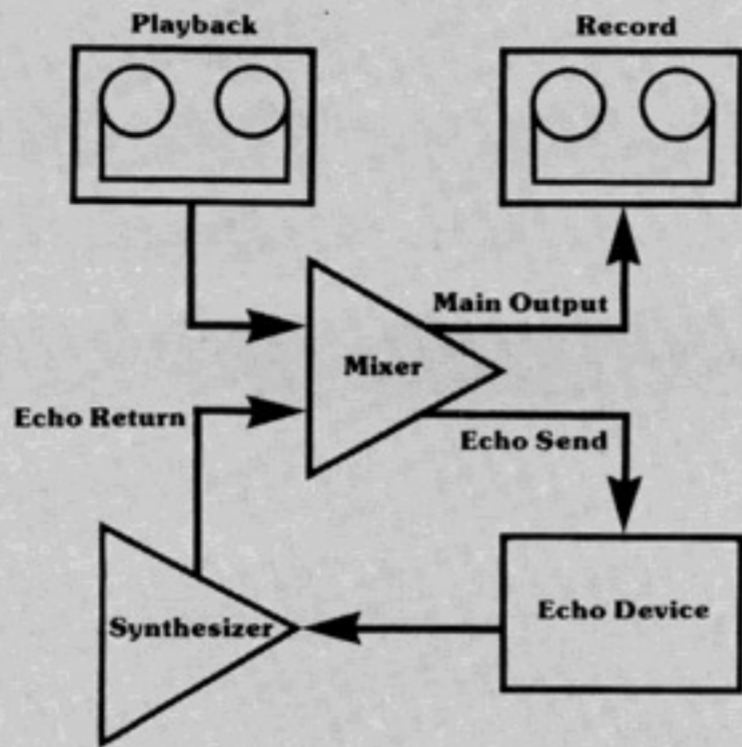

Figure 1: Ambience Processing Patch.

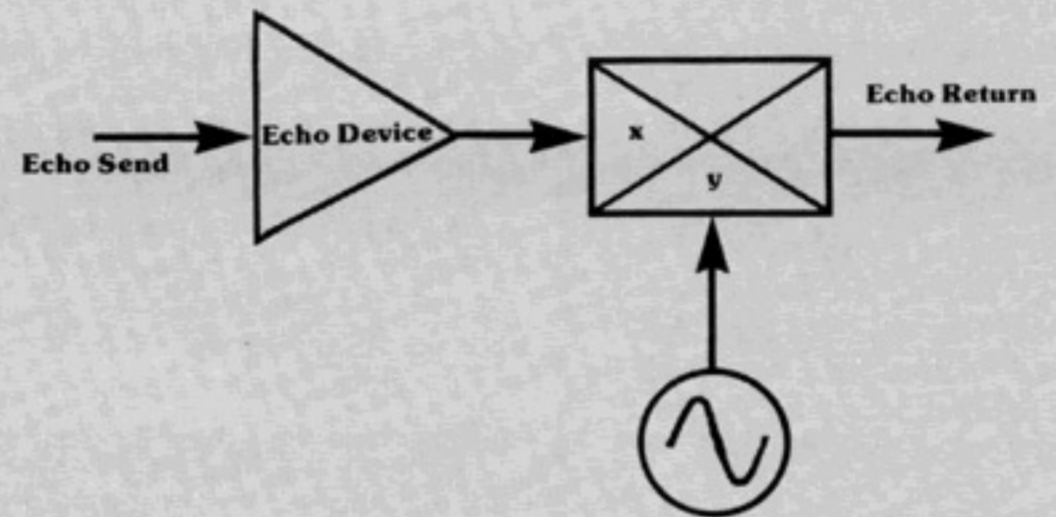

Figure 2: Gating Ambience.

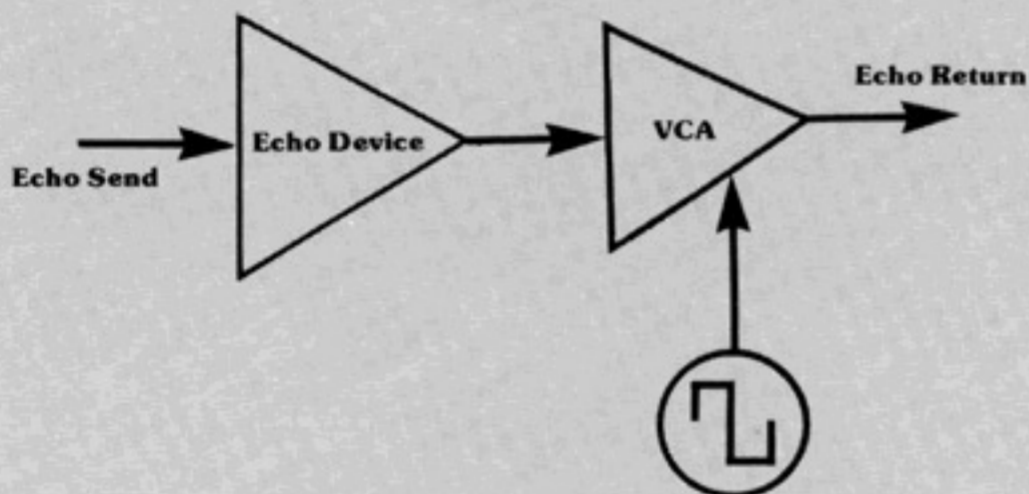

Figure 3: Ring Modulating Ambience.

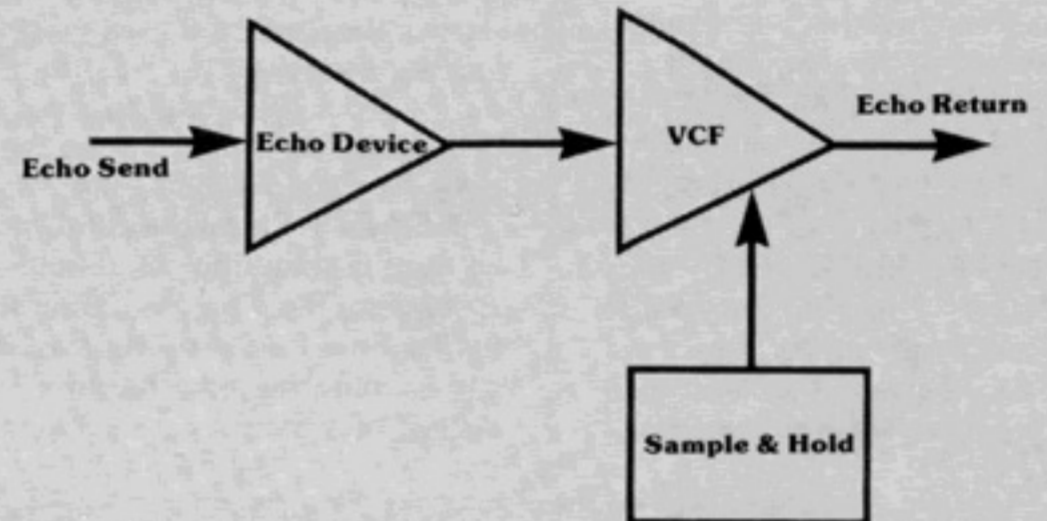

Figure 4: Filtering Ambience.

Synthesis

from page 43

Delaying a reverb unit makes the apparent space much larger. Changing the speed of the delay while creating echo results in warping the ambience. A Harmonizer, or frequency shifter, works particularly well at this, because they transpose the frequency of the sound farther up or down with each succeeding repetition.

Gating the echo with a VCA, and then controlling the VCA with a slow square wave results in the square wave beating against the delay time. A reverb chamber in place of delay in this circuit will pulse on and off as it decays (Figure 2).

Digital delays shorter than 50 ms. echo with frequencies in the audible spectrum and function as oscillators. Using Amplitude Modulation as well as Ring Modulation with short delays will therefore generate sidebands.

Another way the ring modulator can be used is to modulate the

echo itself (Figure 3). Modulating reverb will create all sorts of bell sounds that decay as the reverberations decay. Modulating a delay line causes the sidebands to interact with each other. Each sideband moves progressively up and down in frequency with each repetition.

Running delay or reverb chamber through a filter changes the tone of the echo (Figure 4). By turning up the Q and controlling the filter frequency with sample and hold, a rather sparkling sound is created. This is because any pitch picked out by the filter is repeated over and over. Besides sample and hold, try using a sequencer or several square waves mixed together.

The main difference between processing the original sound and processing that sound being echoed is that the original sound remains pure. The pure sound is then balanced with the processed ambience until the proper perspective is achieved: a sound changing timbre during its duration.

—Danny Sofer

LISTINGS

"Listings" is provided as a service to Synapse readers. Please make full use of these addresses and let those you write to know you found their address in Synapse. Readers with suggestions for additional listings write: Synapse/Listings, 2829 Hyans St., LA, Ca. 90026.

Synthesizer Manufacturers

Advanced Tools for the Arts, P.O. Box 825, Tempe, Ariz. 85281
Analog/Digital Associates, 2316 Fourth St., Berkeley, Cal. 94710
Aries Music Inc., P.O. Box 3065, Salem, Mass. 01970
ARP Instruments, Inc., 45 Hartwell Ave., Lexington, Mass. 02173
Audio Arts, Inc., 5615 Melrose Ave., Hollywood, Cal. 90038

Blacet Music Research, 18405 Old Monte Rio Rd., Guerneville, CA 95446
Buchla, Box 5051, Berkeley, Calif. 94705
CFR Associates*, Box F, Newton, N.H. 03858
Computone Inc./Lyricon, P.O. Box 433, Norwell, Mass. 02061
Concert Company**, 3318 Platt Avenue, Lynwood, Calif. 90262
Dataton AB, Box 257, 2-581 02 Linkoping, Sweden
DBL Electronics, 83 Morgan Circle, Amherst, Mass. 01002
Dennis (Electronic Music Components), 2130 Metcalf, Honolulu, Hawaii 96822
Electrax, P.O. Box 149, Tarzana, California 91356
Electron Farm/Harvest, Gregory Kramer, 135 W. Broadway, New York, N.Y. 10013
Electronic Music Laboratories, P.O. Box H, Vernon, Conn. 06066
Electronic Music Studios, The Priory, Great Milton, Oxford, England
E-mu Systems, 3046 Scott Blvd., Santa Clara, Calif. 95050
Farfisa, 1330 Mark St., Elk Grove Village, Ill. 60007
Galaxy Systems, P.O. Box 2475, Woodland Hills, Cal. 91364

Gentle Electric, 140 Oxford Way, Santa Cruz, Cal. 95060
Heuristics, Inc., 900 N. San Antonio Rd., Los Altos, Cal. 94022
Inner Space Electronics, Box 308, Berkeley, Cal. 94701*
Ionic Industries, 128 James St., Morristown, NJ 07960
Korg/Unicord, 75 Frost Street, Westbury, N.Y. 11590
Logistics, Box 9970, Marina Del Rey, Cal. 90291
MCI, Inc., 7400 Imperial Dr., Box 8053, Waco, TX 76710 (817) 772-4450
Media Mix, 4060 Stanford, Dallas, Texas 75225
Micor, P.O. Box 20885, Phoenix, AZ 85036 (602) 273-4111
MM Electronics, French's Mill, French's Rd., Cambridge, England CB4 3NP
Moog/Norlin, 7373 North Cicero Ave., Lincolnwood, Ill. 60646, Customer Service: 2500 Walden Ave., Buffalo, N.Y. 14225
Musicomputer, P.O. Box 1070, Canyon Country, CA 91351
Music Technology/Crumar, 105 Fifth Ave., Garden City Park, N.Y. 11040
Musitronics Corporation, Sound Lab 10, Rosemont, N.J. 08556
New England Digital Corp., P.O. Box 305, Norwich, Vermont 05055
Oberheim Electronics, 1549 Ninth St., Santa Monica, Calif. 90401
Octave Electronics Inc., 35-73 Steinway St., Long Island City, N.Y. 11103
Octron, 1346 Bayport Avenue, San Carlos, Calif. 94070
Omniphon, Box 166, Churchill Rd., Mason, N.H. 03048
Oznie Process Electronics, Box 7, Centerville, Penn. 16404
PAIA*, Box 14359, Oklahoma City, Okla. 73114
Pollard Industries, Ind., 9014 Lindblade St., Culver City, Cal. 90230
Polyfusion Inc., 160 Sugg Road, Buffalo, N.Y. 14225
Rocky Mount Instruments, Inc., Macungie, Penn. 18062
Rolandcorp U.S., 2401 Saybrook, L.A., Cal. 90040
Saputelli Music Systems, P.O. Box 40267, San Francisco, Cal. 94140
Scalatron/Motorola, 2130 N. Palmer Dr., Schaumburg, Ill. 60196
Sequential Circuits, 1172-G Aster Ave., Sunnyvale, Cal. 94086
Serge Modular Music, 1107-1/2 N. Western Ave., Hollywood, Calif. 90029
Software Technology Corp., P.O. Box 5260, San Mateo, Cal. 94402
Solid State Music, 2102A Walsh Ave., Santa Clara, Cal. 95050**
Star Instruments Inc., Box 71, Stafford Springs, Conn. 06076
Steiner-Parker, 2258 South, 2700 West, Salt Lake City, Utah 84119
Stramp, 3-2000 Hamburg 53, Bornheide 19, Germany
Strider Systems, P.O. Box 2934, Norman, Okla. 73070
Syn-Cordian, 32:73 Steinway St., Long Island City, N.Y. 11103
Syn-Key, 114 W. Hintz Road, Wheeling, Ill. 60090
THINC-Technical Hardware Inc., P.O. Box 3609, Fullerton, Calif. 92634
VAKO Synthesizers Inc, 4651 62nd Avenue North, Saint Petersburg, Florida 33565
Wavemakers, P.O. Box 27, Edmonds, Wash. 98020
Yamaha International, Box 6600, Buena Park, Calif. 90620
360 Systems, (213) 384-8447, 2825 Hyans Street, Los Angeles, Calif. 90026

Note: * manufacturer makes kits only
 ** manufacturer makes both kits and finished product

Consultants

Analog Systems, P.O. Box 1559, Boulder, Colo. 80306 (303) 499-4236

Audio Designs, 3422 Brookfield Ln., Decatur, Georgia 30032 (404) 284-8651
Michael J. Boddicker, (213) 985-0010
Boston Experimental Electronic Music Projects, Robert Ceely, 33 Elm St., Brookline, Mass. 02147, (617) 731-3785
Cincinnati Independent Electronic Studio, David McClanahan, 2703 Coy St., Cincinnati, OH 45219 (513) 421-9025
Clean Music Systems, 131 S. E. Fifth St., Hallandale, Fla. 33009, (305) 454-4601
Danbury Electronic Music Center, 84 Federal Rd., Danbury, Conn. 06810 (203) 792-2794
Different Fur Music, John Vieira, 3470 19th St., San Francisco, Calif. 94110, (415) 863-WAVE
Disco Tech Musical Electronics, Prospect Mall, 2239 North Prospect, Milwaukee, Wisconsin 53202 (414) 271-9291
Dorje Sound, Chet Wood, P.O. Box 2232, Berkeley, Calif. 94702
DS Music, 811 Franklin St., Santa Monica, Calif. 90403, (213) 463-8772
Electronic Music Consulting, Michael W. Gilbert, 104 Riverglade, Amherst, Ma. 01002 (413) 253-2786
Electronic Music Studio, Dwight D. Gatwood, Director, University of Tenn., Martin, Tenn. 38238 (901) 584-7402, 578-2281
Electronic Music Users Studio, 37 Sussex St., San Francisco, CA 94131
The Elektrik Keyboard Ltd., 2213 W. 95th, Chicago, IL 60643 (312) 881-3800

EMSA (Electronic Music Studios of America, Inc.), 269 Locust St., Northampton, Mass. 01060 (413) 586-3777
Entropy West Electronics, Eric Valinsky, 1242 Harvard St., Santa Monica, Calif. 90404 (213) 828-0389
Exploratory Electronic Music, Steven C. Bilow, 16685 Calneva Drive, Encino, California 91436 (213) 789-6885
Keyboard Services, P.O. Box 975, Baton Rouge, La. 70821 (504) 924-3858
Laine Research & Development, P.O. Box 3219, Fullerton, Cal. 92634 (714) 871-1923
Lectron Music Lab, Box 1594, Hollywood, Calif. 90028
Stan Levine, 13508 Debell St., Pacoima, Calif. 91331 (213) 899-7223
Musicians Service Center, 11321 Santa Monica Bl., West Los Angeles, CA 90025 (213) 473-6726
Paradox EMS, Inc., 116 West Broadway, Vancouver, B.C., Canada V5Y 1P3
Patchwork Sound, Jack Howe, 14759 Hesby St., Sherman Oaks, Calif. 91403
People's Computer Company, P.O. Box 310, Menlo Park, Calif. 94025
Pi Corporation, 1741 East 24th St., Cleveland, Ohio 44114 (216) 781-2207
Ron Rivera, 48 Brighton Avenue, No. 11, Allston, Mass. 02134
Ed Schaeffer Enterprises, P.O. Box 26521, 1049 S. Garland Way, Denver, Colorado 80226 (303) 988-9090
John Snyder, Experimental Music Studio, 315 Kear St., Yorktown Heights, N.Y. 10598 (914) 962-5299
Sound Arts, 2825 Hyans St., Los Angeles, Calif. 90026 (213) 487-5148
Dr. Phillip Springer, Box 1174, Pacific Palisades, Calif. 90272 (213) 454-5275
Star Track Recording Studio, 8615 Santa Monica Blvd., Los Angeles, Calif. 90069, (213) 855-1171
Carter Thomas, Manpel Road, Spring Glen, N.Y. 12483 (914) 647-9121
TNY Music & Engineering, Route 4, De-freestville, N.Y. 12144 (518) 283-2837, 283-2899

Schools

BEEP Electronic Music Workshops, 33 Elm Street, Brookline, Ma. 02146 (617) 721-3785
Boston School of Electronic Music, 127 Kilsyth Rd., Brighton, Mass. 02135 (617) 734-4500/4501

Con Tempo Music Guild, 13273 Ventura Blvd., Studio City, California 91604 (213) 784-8271
James D. Craig Music, 511 Cedar St., Allentown, Penn. 18102 (215) 437-4743
Dick Grove Music Workshops, 12754 Ventura Blvd., Ste. 2, Studio City, Calif. 91604
Hawaii Electronic Music Group, Box H-8 Room 213, 2445 Campus Rd., Honolulu, HA 96822 (808) 955-2839
Los Angeles Center for Electronic Music, 8615 Santa Monica Blvd., Los Angeles, Calif. 90069 (213) 652-7655, 463-8772
New England Conservatory of Music, 290 Huntington Av., Boston, MA 02115 (617) 262-1120
Omega Intermedia Center, 3433 North Halsted, Chicago, Ill. 60657 (312) 477-9863
PASS Public Access Synthesizer Studio, 135 W Broadway, New York, N.Y. 10013
Sherwood Oaks Experimental College, 6353 Hollywood Blvd., Hollywood, Calif. 90028 (213) 462-0669

Sound Products & Accessories

Alembic, P.O. Box 759, Sebastopol, Calif. 95472 (707) 823-8579
Audio Pulse, 4323 Arden Dr., El Monte, Cal. 91731
Audio Rents, 6656 Sunset Bl., Hollywood, CA 90028 (213) 461-3351
Barcus-Berry, 15461 Springdale St., Huntington Beach, Cal. 92649
Carvin Music and Sound, 1155 Industrial Ave., Escondido, Cal. 92025
E Bow/Heet Sound Products, 611 Ducommun St., Los Angeles, Calif. 90012 (213) 687-9946
Electro-Harmonix, 27 West 23rd St., N.Y., N.Y. 10010
Electro-Voice, 674 Cecil St., Buchanan, Mich. 49107
Eventide Clockworks, Inc., 265 West 54th St., New York, N.Y. 10019 (212) 581-9290
FRAP, Box 40097, San Francisco, Calif. 94140 (415) 824-2223
FROGG (Design Engineering Labs Inc.), 4121 Redwood Ave., Los Angeles, Calif. 90066 (213) 823-8220
Hammond, 4200 Diversey, Chicago, Ill. 60639
Heil Sound Systems, Heil Industrial Blvd., Marissa, Ill. 62257
Ibanez/Elger Co., P.O. Box 469, Cornwelles Heights, PA 19020
Infitheatre Inc., 4990 Mass Ave., Indianapolis, Ind. 46218
J.D. Electronics, Inc., P.O. Box 2205, Berkeley, Cal. 94702
Marshall Electronic, Box 177, Joppa, MD. 21085
Mellotron/Sound Sales Inc., Sherman Conn. 06784
Morley Electronics, 2301 West Victory Blvd., Burbank, Calif. 91506 (213) 843-7122
Musico, 1225 N. Meridian St., Indianapolis, Ind. 46204
Pro Sound, 13717 S. Normandie, Gardena, Cal. 90249
Roctronics Entertainment Lighting, 22 Wendell St., Cambridge, MA 02138 (617) 354-4444
Ross Musical Products/Keas Electronics Inc., 210 W. Main, Chanute, KS 66720 (316) 431-0400
Rothchild Musical Instruments (distributor Furman and Alembic products), 65 McCoppin St., San Francisco, Calif. 94103 (415) 626-2260
The Ken Schaffer Group, 10 East 49th St., New York, New York 10017
Sennheiser Electronic Corp., 10 West 37 St., New York, N.Y. 10018
TAPCO, 3810 148th Av. NE, Redmond, WA 98052 (206) 883-3510
Wasatch Music Systems, P.O. Box 9175, Salt Lake City, Utah 84109

Sound Recording

Ampex, 401 Broadway, Redwood City, Calif. 94063 (415) 367-4544
dbx Incorporated, 296 Newton St., Waltham, Mass. 02154 (617) 899-8090
Dokorder, 5430 Rosecrans Ave., Lawndale, Calif. 90260
Dolby Laboratories Inc., 731 Sansome St., San Francisco, Calif. 94111 (415) 392-0300
EDCOR, 3030 Red Hill Ave., Costa Mesa, Calif. 92626 (714) 556-2740
Furman Sound, 616 Canal Street, Suite 25, San Rafael, California 94901 (415) 456-6766
Magnetic Reference Laboratory Inc., 229 Polaris Avenue, Suite 4, Mountain View, Calif. 94043 (415) 965-8187
Maxell Corporation of America, 130 West Commercial Ave., Moonachie, New Jersey 07074
Orban/Parasound, 680 Beach St., San Francisco, Calif. 94109 (415) 673-4544
Otari Corporation, 981 Industrial Road, San Carlos, California 94070 (415) 593-1648
Scientific Audio Electronics Inc., P.O. Box 60271, Terminal Annex, Los Angeles, Calif. 90060
Scotch/3M Magnetic Audio/Video Products Division, 3M Center, Saint Paul, Minn. 55101
Scully Recording Instruments, 475 Ellis St., Mountain View, Calif. 94943
Shure Brothers Inc., 222 Hartrey Avenue, Evanston, Ill. 60204
TDK Electronics Corporation, 755 Eastgate Blvd., Garden City, N.Y. 11530
TEAC Corporation of America, 7733 Telegraph Road, Montebello, Calif. 90640
Telex Communications Inc., 9600 Aldrich Avenue South, Minneapolis, Minn. 55420
United Recording Electronics Industries, 8460 San Fernando Rd., Sun Valley, CA 91352 (213) 767-1000

Classified Ads

Classified Ads: Synapse provides classified ad space at a minimum rate as a service to our readers. Ads are accepted from private parties only. 20 words or less \$2.00, 40 words or less \$5.00, 60 words or less \$15.00. Enclose payment with ad and send to: Synapse Classified Ads, 2829 Hyans St., Los Angeles, CA 90026.

Wanted to buy: MUSE BINARY SEQUENCER manufactured by Triadex Corporation. Call or write (215) 922-0211 (m-f; 9-5) Art Noel, Box 913, Havertown, PA 19083.

For Hire: Chamberlin M-lb. 8 instruments—Violin, Cello, Female, Male voices, Flute, Bells, Vibraphone, Sound Effects. L.A. Area \$150 per day (714) 599-2624.

New Electrocomp 101 Polyphonic Synthesizer, patchable like ARP 2600, multi-mode filter, sampler envelopes, ring modulator, etc. \$1150. (314) 468-4447.

FOR SALE: ARP 2500 Synthesizer. Used (and therefore available at a good price) but expertly maintained. Contact Joe Hardy at Ardent Recordings (901) 725-0855 between 10:00 AM & 6:00 PM C.S.T.

what's happening

from page 11

tors, and a seven band anti-feedback graphic equalizer on the monitor send. Prices range from \$749.00 to \$2548.00. For information, write: Malatchi Electronic Systems, 3731 E. Colfax Ave., Denver, CO 80206.

... **DOD Electronics Company** is now offering a line of processing boxes. Of special interest to the synthesist are the **Resistance Mixer 240** (\$29.95), usable as a four-in-one out mixer, or as a four channel Y cord, and the **Electronic Phasor** (\$89.50) featuring 1080° of phase rotation. Contact DOD Electronics Company, 495 East-2700 South, Salt Lake City, Utah 84115.

... If your practice room or home recording studio is too live for accurate monitoring, or the sounds bother your family or roommate, check out **Robac** panels, distributed by **KNR Audio Research and Development**, P.O. Box 3174, Centerline, Mich. 48051. The panels are being used successfully in both musical and industrial applications, and sell for \$35.00 per box, each box capable of covering 8 sq. feet.

... **Rhino Records** will present, in cooperation with the **Century City Educational Arts Project**, an April series of improvisational jazz concerts at the **Century City Playhouse, Los Angeles**. Performing in the series will be **Nels Cline** (April 9th), **Baikida E.J. Carrol** (April 16th), **Leo Smith** (April 23rd), **Air** (April 24th), and **Hamiet Bluiett** (April 30th). All concerts start at 8:30 PM. Call (213) 474-8685, 475-8388, or 839-3322 for information.

... **The UCLA Committee on Fine Arts, Some Serious Business, and The Electro-Acoustic Music Network** join in presenting a concert of Japanese electronic music, piano music, and film, by **Toshi Ichiyanagi**. The concert will be held April 9th at the Dickson Art Center, UCLA, and will begin at 8:00 PM.

... **Saputelli Music Systems**, a small Bay Area manufacturer, is offering some very interesting modules for use in a modular system, or in expanding an existing system. All of the modules have their own regulated power supply included in the price. The \$275.00 **Frequency Transmuter** will divide and multiply input signals, and all of the divisions are available simultaneously. The unit can be used with both audio and sub-audio, allowing melodic and rhythmic functions. Output filters (7) are provided to alter the harmonic values of the square wave outputs.

Gizmo

It was one of the most curious product unveilings at the January NAMM Expo. While most manufacturers fought to get their instruments into the hands of well known artists, the makers of the Gizmo did the opposite. Creators Lol Creme and Kevin Godley (y'know, 10CC, formerly of) took the wraps off their prototype mechanical bowing device for electric guitars. For the last six years the duo had been perfecting, or as they put it "simplifying" a device that would allow independent notes or chords to be voiced with a bowed sound.

It all began one day in the studio. Honoring the age-old tradition of arranging strings without the benefit of a string orchestra, Mr. Godley took after Mr. Creme and his Stratocaster with an electric drill. One thing led to another (safely,

we must assume, as the pair are still collaborating), a prototype was developed with the assistance of John McConnell at the University of Manchester, Manchester, England. Godley/Creme released four sides of Gizmo vinyl (Consequences, Mercury SRM-3-1700), and established Gizmo, Inc. in conjunction with Musitronics of New Jersey for commercial development of the soon-to-be product.

The Gizmo consists of six electrically driven wheels that correspond to the six strings of an electric guitar. It mounts over the bridge without any modification to the guitar except for mounting screws. The guitar strings are bowed when any of six buttons located on the top of the unit are depressed. The player frets with the left hand and is free to pick the strings or bow with the Gizmo. Delivery is slated for Fall '78 with the price set at \$250.00 complete with mounting hardware and battery eliminator.

The \$750.00 Pitch Shifter-113 will shift a microphone or line level input greater than one octave above, or below the original frequency. The shift is voltage controllable with one volt per octave calibration. A twelve-place LED meter indicates the shift in whole steps. A **Digital Foot Controller** is also offered. It is designed to add complex control in situations such as live performance. The controller extends 1/4 inch off the floor, and contains 4 pressure cell switches, 2 momentary switches, and 1 linear output pressure pad. The overall length of the \$200.00 controller is 33 inches. The manufacturers are quick to point out in their literature that these, and others of their modules, may be limited for certain applications, and that the user should consider them in light of their particular application. Saputelli Music Systems, P.O. Box 40267, San Francisco, Cal. 94140.

... New in the family of percussion synthesizers from **Star Instruments, Inc.**, is the **Synare 3**. The \$195.00 unit is velocity sensitive (the harder you hit it, the louder or brighter it is) and runs on two 9-volt batteries that manufacturer's literature states will "last up to six months of ten hour/day playing." For information write: Star Instruments, Inc., P.O. Box 71, Stafford Springs, Conn. 06076.

... **"Cal Jam"** jammed. Despite a scarcity of bathrooms, sunshine, and just plain old open space, electronic music fans were heartened March 18th at the California Jam II, whose 220,000 paid at-

tendance made it the largest single day rock concert in history. Fully eight of the nine bands performing employed synthesizers in their sets, including **Bob Welch, Santana, Heart, and Foreigner**. Only the certifiably insane **Ted Nugent** stuck to a strict axe attack. After headliner **Aerosmith**, the audience enjoyed a laser show, set to **Jean Michel Jarre's "Oxygene."**

... Two electronic music concerts are scheduled for May at **Moorpark College**, Moorpark, California. On May 2, a student concert of electronic music will be presented. Admission is \$1.50 with proceeds benefiting the jazz band and the electronic music department. On May 22, **Ingram Marshall** will present a concert of his music, and admission is free. Both concerts will take place at 8:00 PM in room M-109 of the music building. For more information, call: (805) 529-2321 ext. 207.

... **Dan Wyman** and **Rodney Oakes** will be giving a concert of electronic music at **Los Angeles Harbor College** on May 12. Admission for students will be \$2.00, and \$3.00 for the general public. The concert, which is scheduled to begin at 8:00 PM, will be held in the Recital Hall at 1111 Figueroa Place, Wilmington, CA 90744. Tel: (213) 518-1000.

... **Blacet Music Research**, 18405 Old Monte Rio Rd., Guerneville, Cal. 95446, is releasing several music synthesis kits, two of which appeared previously as construction projects in Synapse. the **Digital Pattern Generator**

sells for \$56.00, and is similar to an analog sequencer, but with many unusual features. For a complete description, see page 39 of Synapse Vol.2, No.3. The **Voltage Controlled Clock with Event Arranger** (\$59.00) outputs pulses with speed variable over a wide range, and the rhythmic placement of the pulses can be programmed on three independent sets of switches. See page 44 of Synapse Vol.2, No.4 for a complete description. New is the **Frequency Divider** for \$42.00. It features divisions resulting in square wave outputs a fifth, an octave, and two octaves down from the input. A programmable divider for division from 2 to 4096 is also provided.

... **Ibanez** has released the **AD-230 Analog Delay and Multi Flanger**, list \$850.00. The delay section has four ranges with delays variable from 10ms-75ms, 10ms-150ms, 10ms-300ms, and 10ms-600ms. Regeneration controls the number of echo repeats, and an LFO is included to produce periodic effects. The flanger section has delay variable from 1-13ms, control over the bandwidth of flanged frequencies, an LFO, mix of flanged and original signal, and regeneration.

... **MCI, Inc.**, 7400 Imperial Dr., Box 8053, Waco, Texas 76710, the makers of **Guitorgan**, have come out with the **B-35-S Guitorgan/Synthesizer** using a keyboardless **Steiner Synthacon** synthesizer. Models are also available that will interface with other brand systems. System configurations range in price from \$1695.00 to \$349.00. The full system allows the playing of guitar, synthesizer, and organ simultaneously.

... The sixth annual **"Explorations"** electronic music concert will be hosted by **Buzzclick Music**, Friday, May 26 at 8:30 PM at the Birmingham Auditorium, Van Nuys, Cal. Featured will be tape and film pieces by **Jon Appleton, Richard Bailey, Pril Smiley**, the **Electric Weasel Ensemble**, and live performances by **T.E.S.E.** There will be a \$1.00 donation for admission. Call (213) 881-1580 for more information.

... **EAR**, a Bay Area publication concerned with "new" music, has resumed publication after a year of inactivity. Although EAR is created by and for Bay Area composers and performers, the interviews and some columns will be of interest to many musicians in any area. Subscriptions are \$6.00 per year in the U.S. For more information and subscriptions, write: EAR, 306 Fair Oaks No. 4, San Francisco, CA 94110.

**It won't be long until you
subscribe to Synapse.**

But by then you will have missed a lot. Keyboard players aren't the only ones playing synthesizer anymore. The field is getting harder to keep up with. Through interviews, equipment reviews, disc reviews, technique features, construction articles, and a long list of regular features, Synapse keeps you in touch with the instruments that make today's music. More important, Synapse puts you in touch with the people who play them.

Subscribe now!

In the US: One year/six issues: \$8.00. Two years/twelve issues: \$14.00. One year/six issues by First Class mail: \$14.00. **Outside the US:** One year/six issues by surface mail: \$10.00. Two years/twelve issues by surface mail: \$18.00. One year/six issues by Air Mail: \$20.00. **For the current issue of Synapse only:** Send \$1.50 plus 50¢ for First Class postage and handling. All orders must be prepaid in US funds. Send all orders to Synapse, Subscription Department 2:5, 2829 Hyans Street, Los Angeles, California 90026.

INTERNATIONAL ELECTRONIC MUSIC



If you could
play this page,
you'd hear what
great pickups
are all about.



DiMarzio

Musical Instrument Pickups, Inc.

643 Bay St., Staten Island, N.Y. 10304

(212) 981-9286