

# HOW TO BUILD YOUR OWN LIVING STRUCTURES

**KEN ISAACS**

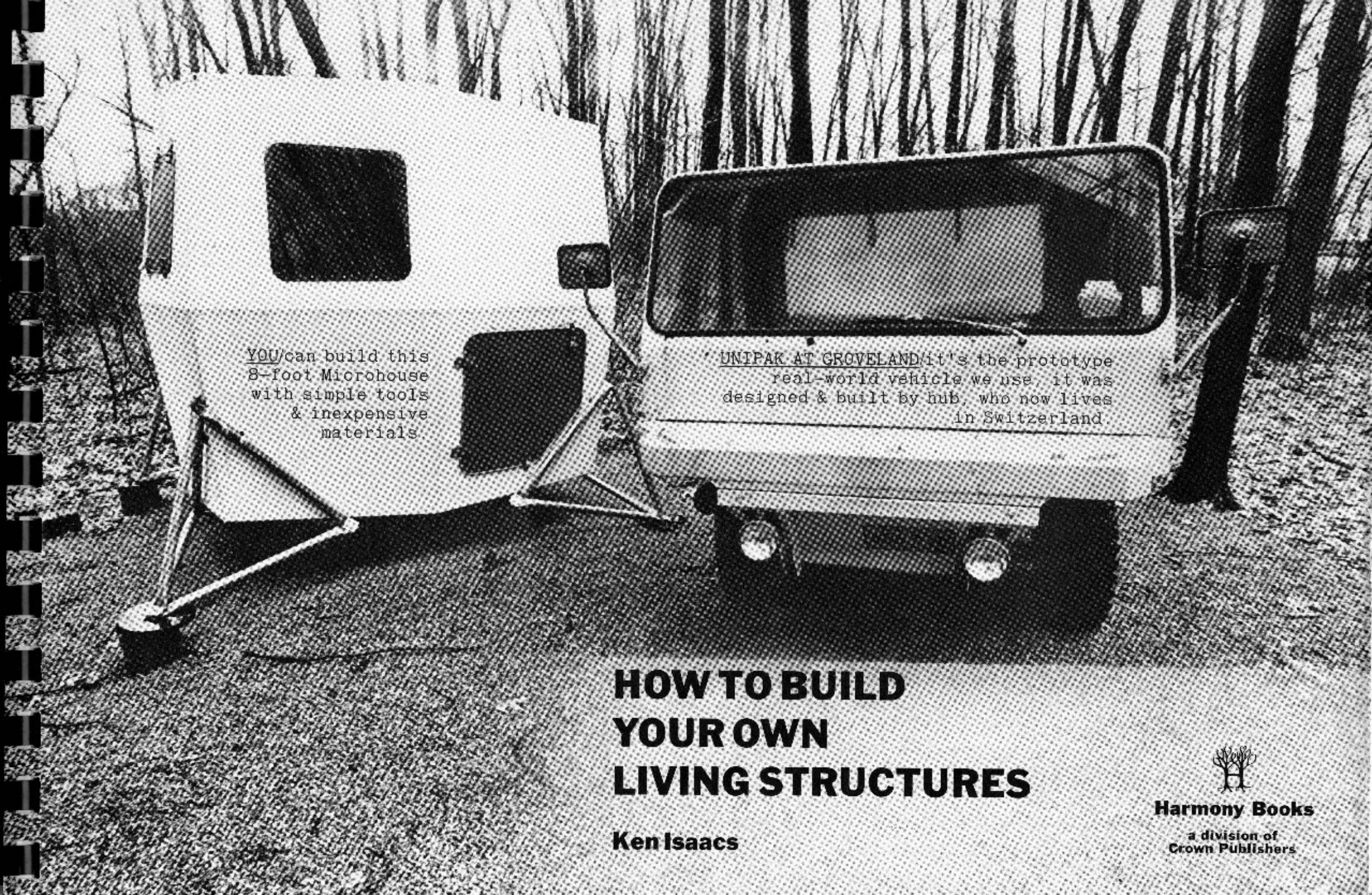

YOU can build this  
8-foot Microhouse  
with simple tools  
& inexpensive  
materials.

UNIPAK AT GROVELAND it's the prototype  
real-world vehicle we use. It was  
designed & built by hub, who now lives  
in Switzerland.

## HOW TO BUILD YOUR OWN LIVING STRUCTURES

Ken Isaacs



Harmony Books

a division of  
Crown Publishers

© 1974 by Ken Isaacs

Library of Congress Card Catalog Number: 72-96651

All rights reserved. No part of this book may be reproduced or utilized in any form or by any means, electronic or mechanical, including photocopying, recording or by any information storage and retrieval system without permission in writing from the Publisher.

Harmony Books  
a division of Crown Publishers, Inc.  
419 Park Avenue South  
New York, New York  
10016

Printed in the United States of America

Published simultaneously in Canada by  
General Publishing Company Limited.

GROVELAND/a long time ago joe & mother & me put \$3000 together to buy 18 mostly timber acres in the rolling country near the illinois river. the timber was second growth just coming back from being plundered for coal mine props early in the century. the cleared meadow land sure looked rusty & unproductive.

BUT/joe was really henry wellie isaacs, ex-kentucky boy/horse trader/earth-nourisher & general survivalist. he discovered ice cream on a stick (but lacked money for patents) & drive-in eating systems in the twenties, did night janitor work in kansas city plus share-cropping during the depression. when they moved back to the land he was coming down from a bad time selling used-cars. that hurt him a lot. humane intelligence set him up as an urban victim. one morning he declared an end to the gentle, but obsessive, drinking & returned to the land. he recycled an old barn, the crates from a microwave tower & some windows from a burned vaudeville theater to make a tight, appropriate shelter for about \$185. some went for sawmill cottonwood lumber, but most for wiring, stove & asphalt shingles.

JOE'S PARTNER/mother, was marie neville, grape-arbor girl, fancy prairie, illinois, 1925. she could make blackberry cobbler, do noodles from scratch, quilt & get a sheet clean with homemade soap. she was a slim, rangy person, one of the world's great woods-walkers & movie-goers. her laughter was as sweet as her technology.

THESE TWO/were pretty formidable & they turned the little patch of ground into a rich eden of good experiences. most of the years i was involved in a surreal wheat-stonian series of oscillations taking place in nyc (geographically) & fantasyland about design & the industrial establishment. strange & schizy because years before when just starting college i experienced the massive comprehensive rush of overview.

probably as a result of ruth benedict, durant, huxley & mumford i began to factor the environment & see the world entire for the first time. it was a rich period which saw the construction of the first Living Structures & Microhouses.

MOST IMPORTANT/i saw & felt the necessity for major simplifications, & recognition of positive earth-relationships & environmental change-therapy to release us all from the high-tech maniacs. but i was a backslider. after teaching a little architecture & design, my pallid attempts to do the urban shuffle were terminated by a neat surprise. i got a fellowship in architecture from the Graham Foundation, so i took the money & students who wanted to live outdoors to Groveland. it was an early (1963) microcommunity which foundered on old-fashioned menu-personality conflicts. but for the year or so it lasted we lived in old schoolbuses, built the american outhouse equivalent of the japanese teahouse & a couple of new Microhouses.

EVERYBODY/split except joe & mother while i burrowed deeper into the loving trees. work on the hardware for a different way of life rolled on. one day i wrote a true letter & got launched into a long series of articles on my designs for a popular magazine. people all over built & used Living Structures & Microhouses, so i became a consulting editor & moved back to nyc. but it's negative to build real things in big cities. my chance came to return to Groveland when a guy in a middle western university asked me to show people about Microhouses, just before taking off with 2 seabags of tools & hardware. i merged at speed with a great ironhead named Carole.

NOW/we're blowing the dust & rust out of Groveland with some new people who also want to tread lightly on the earth.

THE MOST IMPORTANT TOOL/if you think of all the methods & efforts a person brings to bear to get a thing done, the main part is "head-tooling."

TV MAGIC/the culture-conditioning limitation that is the imprint of the media supersalesmen has slightly wrecked our ability to concentrate & severely warped our time-sense. shuffling credit cards & signing monthly payment agreements have decreased our ability to handle the real-time activities of making & being.

PRE-MUZAK TIME/think of time-sense another way. they used to show us the big upright monolithic heads from Easter Island in grade school. the teacher said they were carved on the ground, then spoke with wonder & mystery about "how did the 'simple' savages raise them to a vertical position without the benefits of the Industrial Revolution & the teamsters union?" we sat in our little rows shaking our heads like the airdales in a Rival commerical. it was impossible to conceive of it. but a few years ago Thor Heyerdahl went down there with simple levers & an idea & demonstrated a whole new point of view. he used really tiny graduated systems of pebbles & just lifted a stone head a hair at a time. it apparently worked pretty nicely. he almost did it in just a day with no more than four or five people.



# HEAD-TOOLING

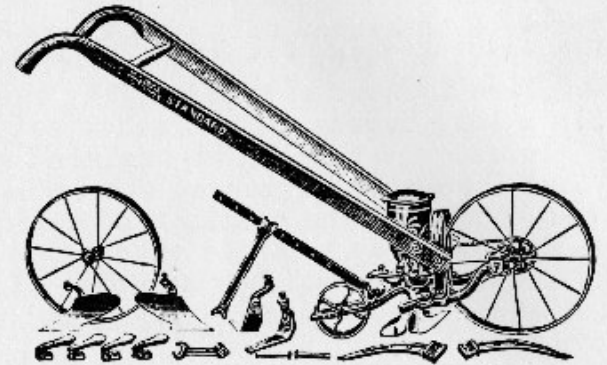

REALITY WARP/the wierd point of Easter Island is that it didn't take those guys forever to do this, it didn't take long at all. have we been oversold on complicating & elaborating our tooling process with complex, expensive (cosmically, ecologically) mechanized aids in hope of timesaving? then for what is the time saved? to be starved & crazed; to fill by reading Playboy or running around breaking radio aerials off parked cars?

it makes about as much sense as a 1½-hour drive on the Long Island Expressway to make the less-than-2-hour flight to Chicago.

DETUNING/we're going to detune individually & seek more steady rhythms in ourselves. generally this improves the ability to concentrate. concentration is a great & precious state of grace. i think it valuable because it is a sign that i'm really getting into & penetrating what i'm doing. in some imprecise sense it is the reverse of alienation. just hand the next two-year-old kid you run into his first rubber band & observe how integral concentration is to the human animal.

ADVANTAGES OF SIMPLE TOOLING/this same concentration permits us to set about breaking the relentless grip of a culture which demands that we have the newest, biggest & fastest power tools before we begin building anything. it will make it possible for us to utilize, understand & control simple tooling. the ability to use simple tooling effectively is not just good for our state of being but from a pragmatic point of view it means you can build without investing too much of your economic resources. in ecological terms, if that investment is low the result is personal independence & the handmaidens of personal independence are beyond price for they are gentle assurance & non-violent self-confidence.

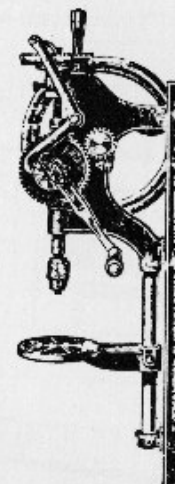

INCREASE SENSITIVITY/once you simplify the tooling & get deeper into the characteristics & capabilities of each tool, you begin to get more precision in your results. by focusing on a tool you find what it will do & how it does it but more important, how your action augments, modulates or negates its performance. if you use it enough & your observation-sensitivity is operational, you will end by being able to do things with the tool which will surprise & amaze you.

you don't have to be a zen master to recognize that this will result in some pretty peachy changes in your relationship with self & thus with the rest of the universe.

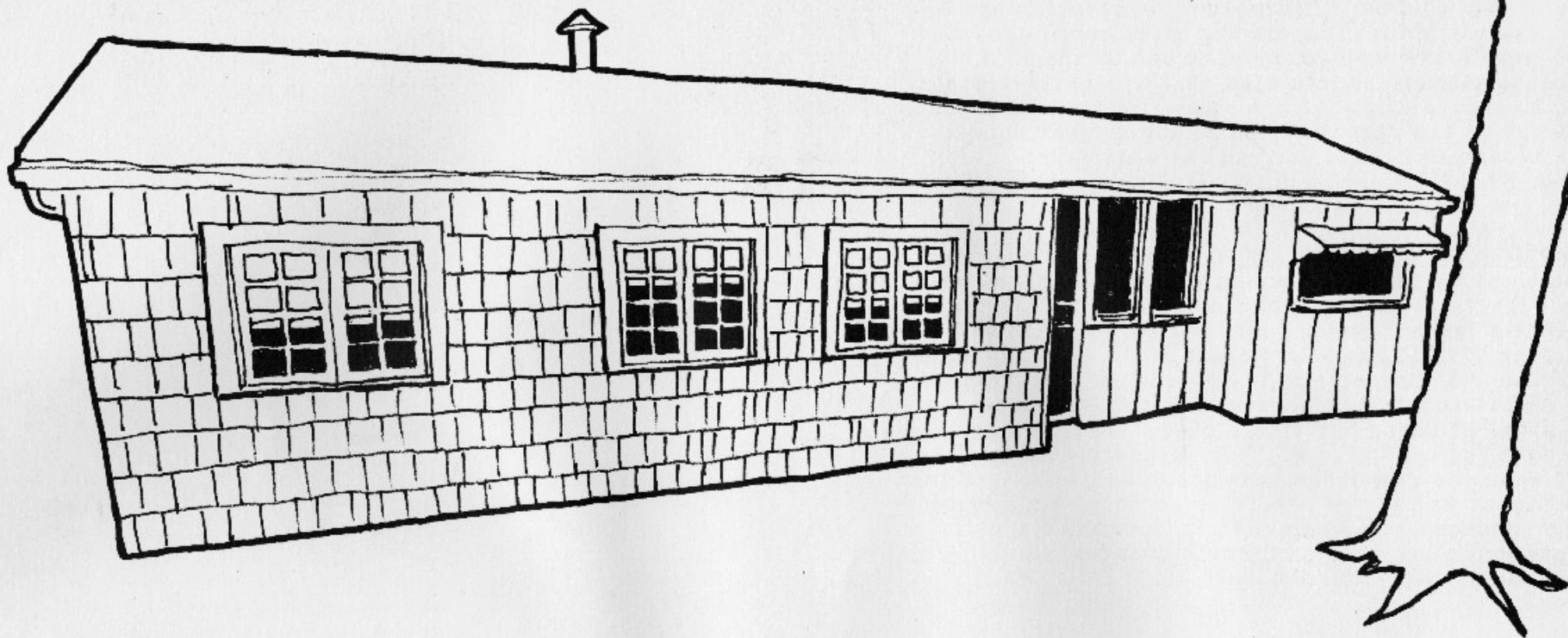

THE \$185 HOUSE/we took two old barns apart. they were just small barns but there was a lot of good lumber in them. no big romantic beams, like House & Garden magazine, just early twentieth-century 4x4's, 2x4's & siding but it was just the thing for framing up a little house in the woods. joe discovered a microwave relay tower going in over on the Peoria road & all the parts had been shipped in fine heavy wood crates. the crew erecting the tower was pretty set on burning them as the usual libation to Mammon & all the gods of waste & consumption but joe, my father, six-packed them out of that. he loaded the old jeep five or six times & the media equipment crates became the sheathing for the house. he found the little old crooked windows in a 1920's movie house that was being wrecked. the \$185 hard money went mostly for shingles, tarpaper, cement & a few new nails.

THE FIRST MICROHOUSE/the first one ever built was a 72" (slightly more than average man height) cube in the Groveland timber. i built it in the early 1950's out of tempered masonite hardboard panels screwed & glued to some 2x2's salvaged from my first Living Structure. people had built small shelters before, mostly in humble unrecorded places like the arid scratchlands of asia & the favellas of the southern hemisphere. all those efforts had the beauty & directness of the bravery & courage of our kind of animal up against the wall doing his sweet best. all the little houses of the past were the status castle, scaled down by malnutrition & exploitation of the builders. i made the Microhouses as one best guess to shelter post-industrial men; compacted & liberated from the "mortgage," "furniture," & "what-will-the-neighbors-say?"

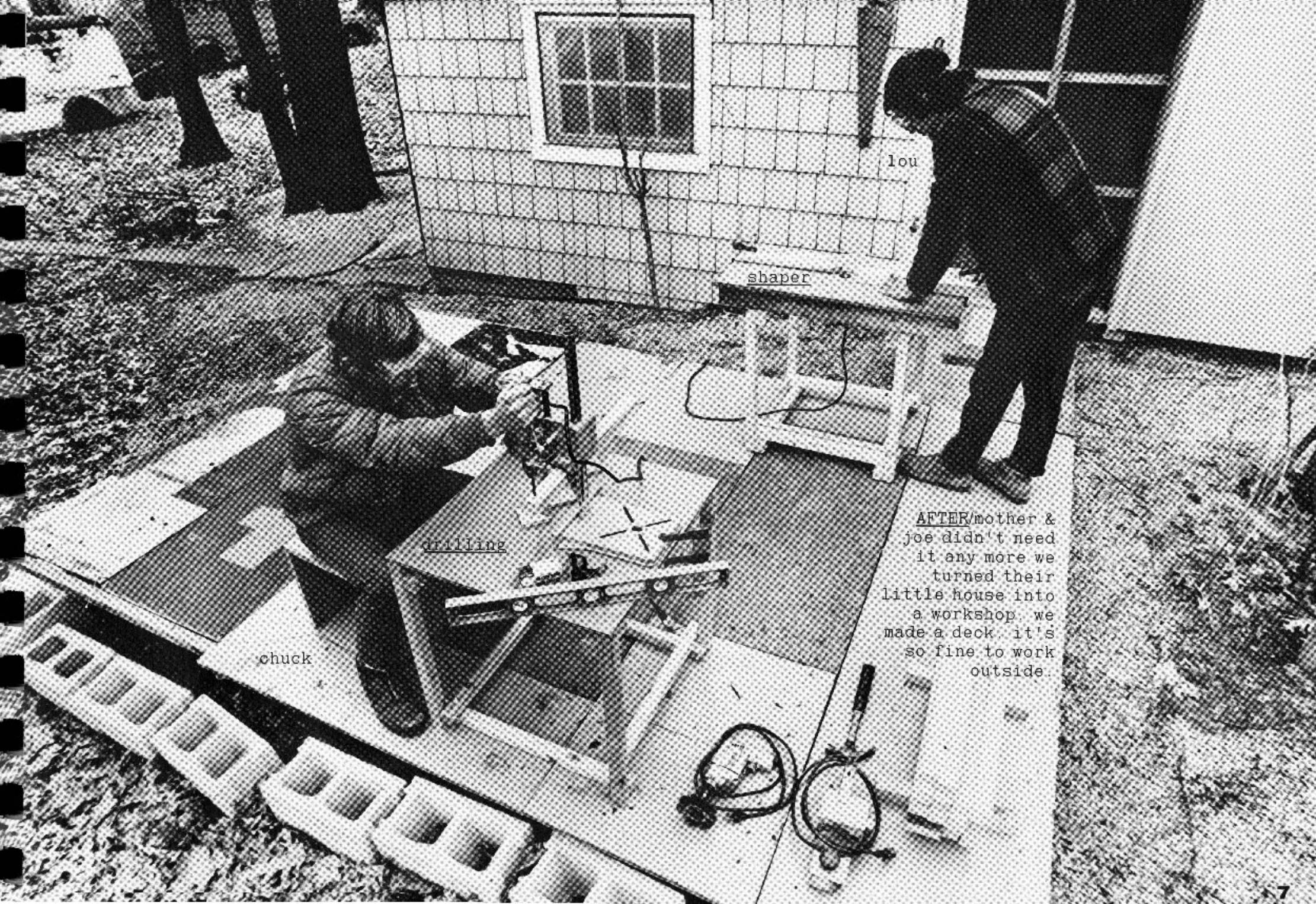

lou

shaper

drilling

chuck

AFTER/mother & joe didn't need it any more we turned their little house into a workshop. we made a deck. it's so fine to work outside.





NEIGHBORS/one of the most important things about any great place is the people across the road. mel & john have sort of held the Groveland thing together through my travels & excursions. they combine computer graphics, canning, growing up in Peoria, housebuilding, raising seven children plus an easy familiarity with all the Parisian monuments & Edinburgh parks. not by being rich in money in the old sense but rather by being competent & whole in head, hand & heart.

10. SETTING UP/making a place to build things & a unit to work on. a step-by-step easy progression that tells you how to buy wood right & how to grade it & judge it. measuring, marking & cutting with the hand saw are covered. inexpensive buying of tools is discussed along with an accurate drilling setup that costs only \$15. how to choose a decent hardware store. shopping list p. 13.
25. NEW SLEEPING LOFT/it doesn't have to fasten to the wall so it moves easy. made from just one kind of member it's easy to change or add to. this 48" module can even be used to build an outdoor shelter. shopping list p. 41.
42. JOSH HENRY LIVING STRUCTURE/this is a personal, individual kid's "house" built in his own room. based on the 36" module it is flexible to grow with the child. shopping list p. 52.
54. INFINITE STORAGE SYSTEM/using one universal panel you can build up, down or sideways in a completely 3-D way & knock it down to 10 per cent of its erected size for moving. shopping list p. 58.
61. CHUCK'S CHAIR/the Panel-Matrix principle is applied to a 24" module to make a classic free chair. shopping list p. 63.
64. ARTICULATED LIGHT BULB/how to make a light bulb float with the minimum support & the maximum movement possibilities. designed to work with Living Structures but it will work on a wall too.
66. MICRODORM 2/this Living Structure is built of light stressed-skin plywood like a bridge. it provides sleeping, storage & study-work in the floor area of a single bed for ages 6-20 or even beyond. shopping list p. 71.

# CONTENTS

74. FUN HOUSE/this outdoor Living Structure for hikers & campers can be erected on leased or short-term-use ground. it's a base camp for a new kind of exploration. shopping list p. 83.
84. SUPERCHAIR/it's a sitting-napping-reading-listening place on a noble eighteenth-century scale. it's even an extra bed. shopping list p. 93.
94. 8' MICROHOUSE/you can build this getaway shelter capsule in your apartment for about \$300 with hand tools. then it will go to the country in a station wagon. several will make a family village with privacy for all. shopping list p. 104. legalities & zoning p. 106.
108. OLD MICROHOUSE/i've been living in this one off & on since 1962 & we keep using the properties of flexibility & expandability that are unique to it. it can be started for about \$1800 & added to as you make it. shopping list pp. 124-25.
126. IN WORK/this is some of the stuff we are working on right now: a new vertical Microhouse in a pipe-frame Matrix at Groveland; new wooden fittings for joining tubing that you can fabricate in your basement or garage with simple tools; a New World pickup truck made of plywood panels & based on the available VW floor pan & running gear; the Dragonfly catamaran houseboat using modular construction; & a new 18' Microhouse with internal Matrix & multiple, overlapping living levels.

BEGINNING/the best way i know to get into Living Structures is to make a 24" cube. it's a chance to perfect all the operations involved in larger Structures & the modules are really useful when you work with wood or metal at home. the units make good tables to mark & saw plywood & 2x2's on. they are fine, stable tool stands for the little electric drill press.

USES/the 24" module is a good workbench for josh henry & i use several as desks, typewriter tables & drawing board bases. you can bolt modules together for larger work surfaces or small painting scaffolds.

## 24" MODULE

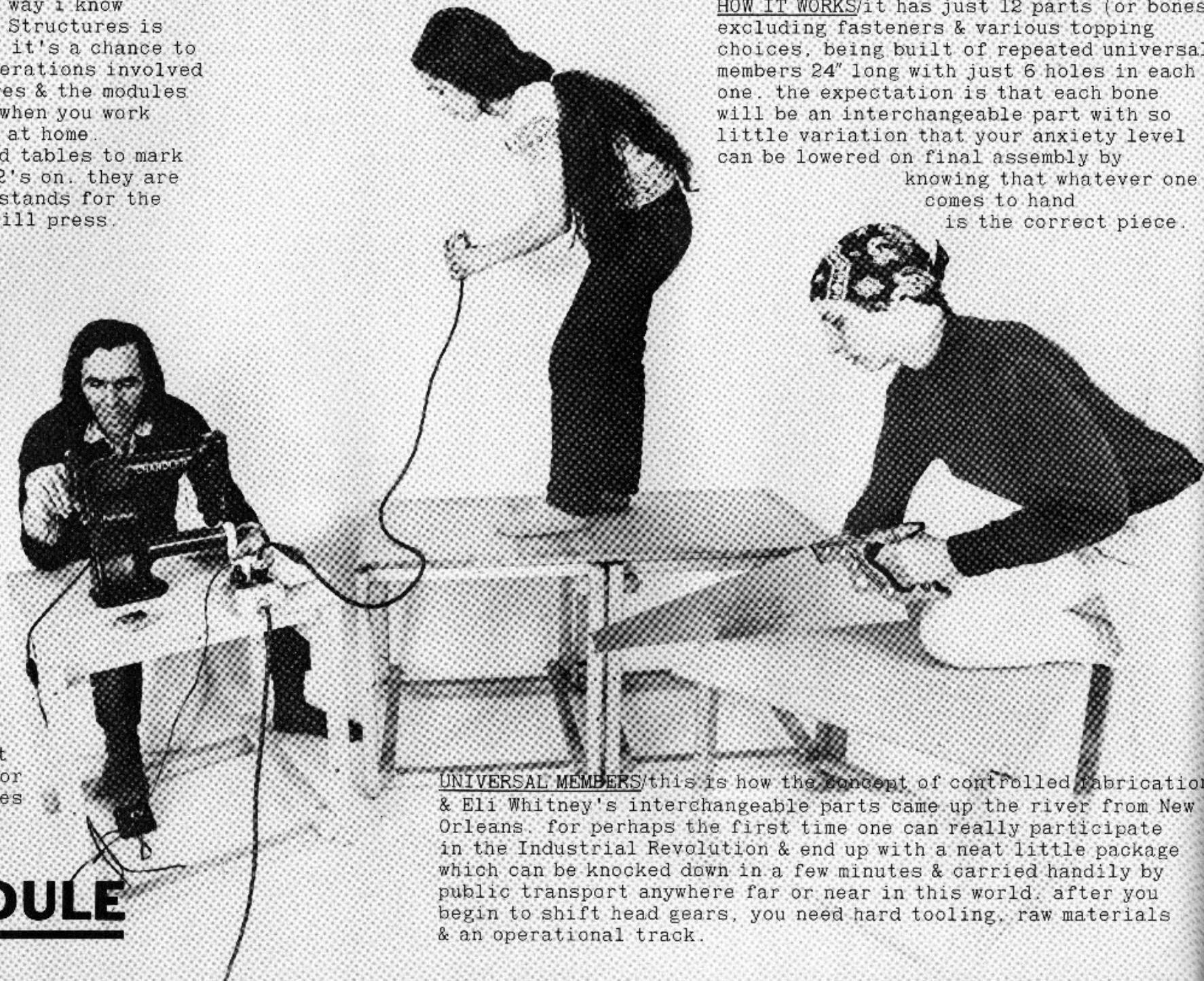

HOW IT WORKS/it has just 12 parts (or bones) excluding fasteners & various topping choices. being built of repeated universal members 24" long with just 6 holes in each one. the expectation is that each bone will be an interchangeable part with so little variation that your anxiety level can be lowered on final assembly by knowing that whatever one comes to hand is the correct piece.

UNIVERSAL MEMBERS/this is how the concept of controlled fabrication & Eli Whitney's interchangeable parts came up the river from New Orleans. for perhaps the first time one can really participate in the Industrial Revolution & end up with a neat little package which can be knocked down in a few minutes & carried handily by public transport anywhere far or near in this world. after you begin to shift head gears, you need hard tooling, raw materials & an operational track.

MYSTIQUE OF THE LUMBERYARD/it might help right now if i outline my head-tooling for going to the lumberyard. any good person resists the easy pleasures of cynicism when faced with negative behavior. on the other hand these are parlous times (maybe all times were) & it is helpful to approach the lumberyard with an alert mind. certainly, not chip on the shoulder, but alert & taping all that happens. maybe it's just that some guys in the business have been spoiled by the easy pickings represented by all those do-it-yourselfers who roll in every Saturday morning in the \$5500 station wagons with eyes as wide as Venusian space pilots. anyway, there is generally quite an attitude there & it is a barrier to getting usable materials. you must work out ways of getting around it.

THE GREAT TELEPHONE SWINDLE/the first thing is, don't order by phone. it doesn't work & you will get the wrong thing or an unusable thing that way. one of the marvels of modern times is the way a perfectly nice guy will either con you or at best give short shrift by phone when he wouldn't do the same face-to-face, one to one. truly the telephone is an instrument that fosters alienation.

UNDERSTANDING WOOD TERMINOLOGY/first off, if you haven't contacted the lumber-business brand of insanity yet, accept the fact that a 2x2 piece of wood is not really 2 inches by 2 inches measured in cross-section. it may have measured a full 2 inches square at some time in its life but by the time kiln-drying & shrinking & planing is done it is only 1½"x1½". in fact, you might find it difficult to get 2x2's for a reasonable price in your area. if you can get lumber cut to these dimensions it's usually better to get that which is planed smooth on all sides (industry code for this is "S4S," or "surfaced on all 4 sides").

## BUYING WOOD

PRICES/several of the people i've talked with lately have mentioned that prices of up to 35¢ per running foot have been charged them. this is really too much & should be nearer 15¢ per foot. what this probably means is that this kind of lumber is a good spot to hook the unwary in. a compelling problem is that i wouldn't even mind paying that much for good sticks but they won't even be that much better than pieces you can latch onto for less if you know how to approach it.

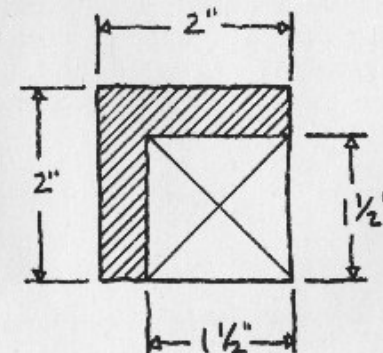

DOING IT/this is where the blueprint part starts. now it doesn't do much good to be on the spot in the yard if you can't influence & modulate the course of events. the only way i've found to do this is by the establishment of a one-to-one relationship with a yard man. (the guys who work lumberyards divide functionally into two operationally based categories, the front guys in the office who do the ordertaking & the salving & the other guys out where the supplies are stored who take your paid receipt, locate your stuff & throw it on the ground by your vehicle. sometimes in small yards these two categories overlap but these are the ground rules.) you do the best you can with the front-office people but it is sometimes hard because they are really just salesmen & the manipulative objectives of this line of work fairly well exclude any massive concern for the customer's well-being. the place to get hip is with the yard man who actually selects & touches the material you will work with later on.

COMMUNICATING/this may generate feelings of personal shallowness in you because most of us have been encultured in the way of holding the cards so no one can see them. this is just a contextual figure-ground problem because the good dream is that we will all become increasingly open with others, even those casually encountered, & talk & share a little bit of what we're occupied with. at best one tries to do this with most encounters, not just those where we hope to elicit a certain kind of performance. so if the intent is positive & general the aspect of manipulation really doesn't apply. we all try to observe this as a general way of behaving & if other people return it you really learn & life gets interesting.

OPENNESS/share a little of what you're building with others. thus it's possible for them to be a little responsive to what you are trying to get. remember that this paltry \$10 worth of flower stems may be the stuff which your life dreams are made of but to the yard man it's just a 2½-minute gig which is only one of thousands which stand between him & his ambition to become a famous brain surgeon. if you tell him what you are into, that is, why you want 2x2's straight & dry, he may get interested in a human way & respond. how would you like to work in a lumberyard where all these madmen with more money than knowledge come in every weekend & buy out the house for some purpose which is unknown & indeterminate to you? alienation is all around us.

WHAT KIND OF WOOD? i haven't said anything yet about what kind of wood you get. most often we use Douglas fir or White fir. i have also heard from people who like spruce 2x2's. the Douglas fir is really good because it is relatively strong (it's a prime choice in the light construction industry). it has long-leaved overlapping hard-grain components which make it strong. these components make the grain prominent under visual observation. White fir is not so strong because the hard-soft parts of the grain are more evenly distributed without the overlapping patterning. it is quite a bit lighter than Douglas fir, which is great when you are lifting or moving finished structures by air freight. the Douglas fir is more orangey in color & oxidizes (with clear finishes) to a richer color on exposure to sunlight. White fir is pretty pristine to begin with, bone white in some cases, & stays lighter through its life. the hard-grain segments make Douglas fir a little more difficult to finish than the White fir, but also a little more resistant to damage from impact or knocks.

HUMBLE MATERIALS/there is a kind of Jeffersonian democratic seeking in taking the most simple & common materials & through careful study, workmanship & shots of soul trying to realize their beauty. it's not that i'm immune to the "finer" woods, because i do respond to historical uses of paneling or guitar veneers or a little piece of teak in the hand. it must be that i just resent the historical imperatives of the middle class which overvalue scarcity or other kinds of expensive exoticism. i guess i don't agree with the idea that diamonds are a girl's best friend. i tend to believe that calcium & phosphorus are.

WOOD/

4 pcs. 2"x2"x96" (8' long)

HARDWARE/

24 pcs. 1/4"-20x3 1/2" flathead machine bolts  
24 pcs. 5/16" flat washers  
24 pcs. 1/4" split-spring lock washers  
24 pcs. 1/4"-20 hex nuts  
4 pcs. 1"-diameter furniture glides, with nail  
(Domes of Silence)  
all hardware to be bright plated (cadmium or zinc).

ON THE LINE/do your rap with the yard man as you go so he knows why "straight" & "dry." (it may take a couple of visits to really establish rapport with the guy but it will be rewarding in many ways when you succeed. i should tell you that we only accept lumber which has been stored in the shed because it seems the stuff that's stashed outside under the polyethylene sheets is usually pretty wild.)

## SORTING

CULLING/three 8' pieces will make the 24" cube. in theory this is true but in practice usually the mills cut short so you can't quite get 4 24" pieces from an 8' mill length. also every time you cut it off you lose between 1/16" and 1/8". getting the extra 8-footer solves this problem & lets you do what my Kentucky grandfather called "culling." that just means sorting & laying by the less desirable pieces & using only the cream. this seems kind of wasteful but since we don't live in a perfect world it gives better results in the structure that you're working on. also you may ruin a piece & need a spare (or want to add a piece or two to modulate the form of the unit). an old European machinist told me once to always make two or three more parts than i planned to use while i was set up for it to avoid going back & resetting up. stay as close as you can to the yard man but don't make him anxious. if he's real busy & you want to gamble, offer to pick them out yourself after assuring him you won't wreck the stack or stay forever. sometimes it works but usually after you get acquainted it works better.

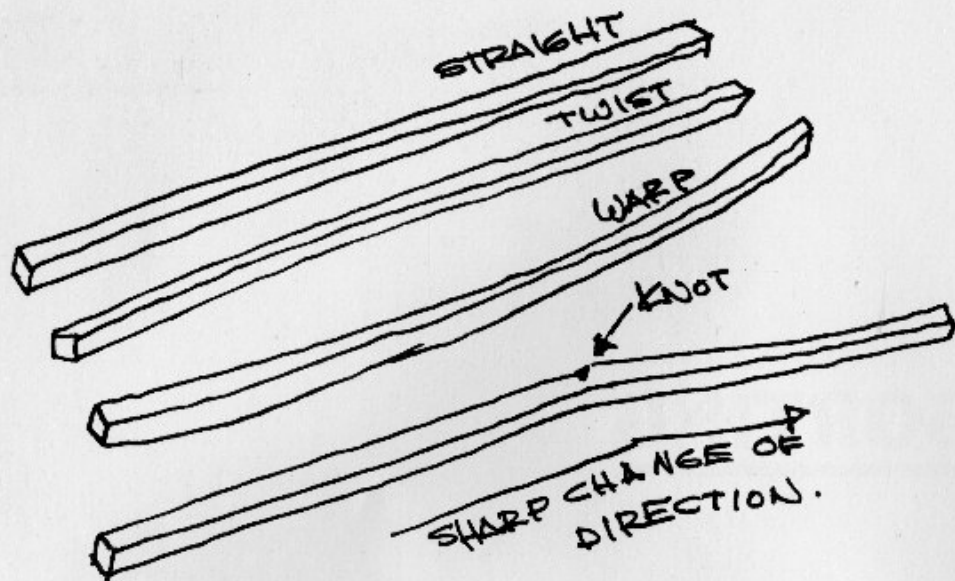

SELECTING THE 2x2'S/as the yard man pulls them, try to touch & handle each one. sight down it to see warp. roll it in your hands quickly to read visible signs. heft it, you'll get so good that you can feel a light, dry, straight piece before looking at it. wet, sappy, crooky pieces feel like a bent water pipe. small tight knots are OK if they don't mark an extreme deviation in long axis. look out for pieces with "checks" (short splits with the grain). these appear because drying stresses have been too severe. avoid pieces with sticky honey-like sap pockets & splits.

## WARPING

SHAPE OF THE ENDS/look at the end of each piece. the cross-section should be fairly square with each angle 90 degrees as at left below. avoid pieces with irregular shape like the one on the right. they won't assemble well.

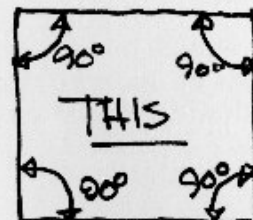

RIPPING FROM 2x4'S/sometimes yards don't stock 2x2's. then buy the best 2x4's you can & scout a friend with a table saw. large cities have neighborhood rec centers with woodshops. small towns have high school shops & college towns have craft workshops. ripping (lengthwise sawing) sequence is at right. better not let lumberyard guys cut anything for you. their cutting is not the best.

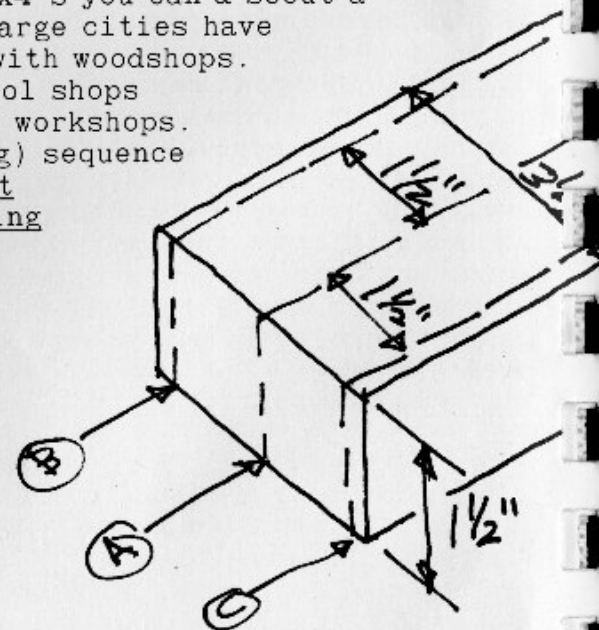

# MEASURE MARK

MEASURING & MARKING/buy a good metal tape 10 feet long & learn the fractions that go with the lines. get a couple of No. 2 pencils & keep them sharp all the time. other kinds of squares will work a little but we always use combination squares for accuracy.

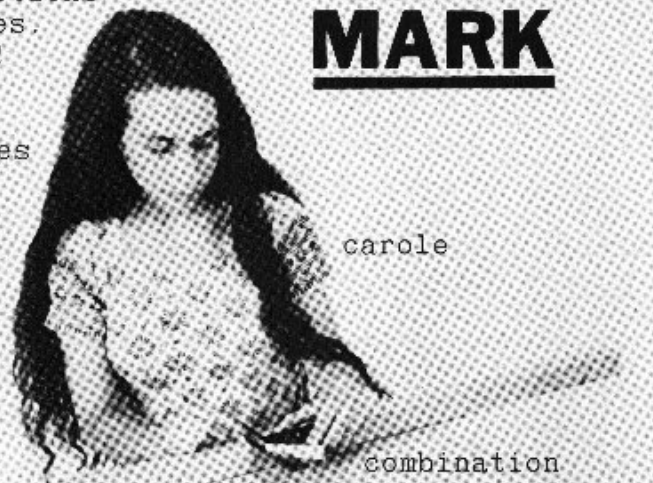

i'd avoid buying either the best (too expensive), or the worst (not truly usable) in this tool. about \$4.50 should do it & for this figure you get a neat little integral scriber which will be great later on for marking dimensions on metal parts. as always, substitute other apparently similar tools with the knowledge that your results may be disappointing.

STORING WOOD/if you're involved in craftsmanship give thought to careful handling & storage of materials. every nick & warp between buying & making adds time finishing & may waste a piece or degrade the finished structure. avoid damp places & temperature extremes. shoot for a good level surface, off the floor & a neat stack.

carole  
combination square  
rasp  
10' tape

# & CUT



SAWING BY HAND/it's a mentalphysical act like zen archery. hold the piece down with hand & knee on something stable. the straight-sawed line begins deep in your mind & concentration & runs through your arm down into the saw. practice on scraps to feel it.



# TOOLS

BUYING TOOLS/the level of a person's skill is a reflection of many things. deep internal qualities of mind & experience are the strongest factors. the heaviest external components are probably the tools. all those i know who build well choose tools carefully. cost is a factor but the price of one item like a steel tape won't break you.

GARAGE SALES & FARM AUCTIONS/try the garage sales for good buys. get into the country to the Saturday farm auctions for the lowest prices. go early so you have a chance to meander & handle & examine the stuff so it's not a blind trade. the old farmers pass & the younger people don't usually feel that those old-fashioned junky tools are supportive of the Gran Prix life style. suburban garage sales are good because many tools are purchased just for the theatrical background effect & they get dumped for little money after the new wears off.

WHAT KIND OF SAW?handsaws come two ways, rip & crosscut. "rip" means to cut parallel to the grain. this type has less teeth per inch & more set. 'set' refers to the way the teeth are bent (alternately) out of the blade plane. this widens the "kerf" "sawn slot in the wood" & prevents binding. "crosscuts" are designed to cut across the grain (as in cutting the 2x2's to length).

for general use i have an old 12-teeth-per-inch crosscut. the fine teeth cut smoother & it still works for rare rips. it cuts plywood with minimal bottom-side splintering.

CHECKING OUT OLD SAWS/look close at individual teeth. are they rounded off & worn down too far? heavy rust is a negative sign. sight down the blade to make sure it hasn't been kinked. even with a new saw make sure the blade is springy & lively. it won't be a good companion if it's too stiff & thick.

THE RASP/one of the most indispensable tools is a four-in-one rasp (sometimes called a "shoemaker's rasp"). it's a no-handle wood file with fine & coarse teeth milled on both sides. one side is flat & the other is slightly curved for curved surfaces. it'll eat up the wood & your hand at first but once you get sensitive to it, what a great tool. it's hard to get a good one where the teeth are really sharp now because the toolmakers seem to be on a McLuhanesque trip where they supply a piece of metal with visual texture, blister-packaged artistically, but you find the rasp teeth are not really sharp. the best one i am using now is a Nicholson.

## WORK PLACE

WORK SPACE/it's easy to buy a saw but it's not quite so easy to find a good place to work & concentrate. a 2½-room apartment offers a couple of choices. clear the "bedroom" for building & sleep temporarily in the "living" room. this is optimum because you can close up the workroom & isolate it. you can alternatively compress the furniture into one end of the main room & work in the opened-up end. keep a vacuum cleaner handy & pick up the saw-dust at frequent intervals. inexpensive plastic painter's tarps over furniture beat air-borne dust.

DRILLING HOLES/tooling for putting accurate holes in lumber is the next number & can be done on several different levels. by now we've most all had the heady experience & ego boost which comes from the small portable electric drill hand-held, almost alive with its 1750 rpm's gyroscoping your wrist as you pull the trigger. what a trip! you feel like Ibsen's master builder with his head screwed on right. ah, power. we'll swiss cheese the farthest reaches of the universe. the only important factor missing here is control. a hole acquires meaning by its position in the board & relationship to other holes in adjacent boards. the long axis of the hole works best if perpendicular to the long axis of the 2x2 & also at 90 degrees in both directions to the face of the piece.

THE OPTIMUM DRILLING SYSTEM/the best of all possible worlds in drilling is the small portable electric drill mounted in one of the relatively inexpensive drill stands now marketed. this solid mounting turns a loose, wandering tool into one which goes where you want it to. combine this with some ideas about immobilizing the 2x2 while you drill it & you can really make interchangeable parts.

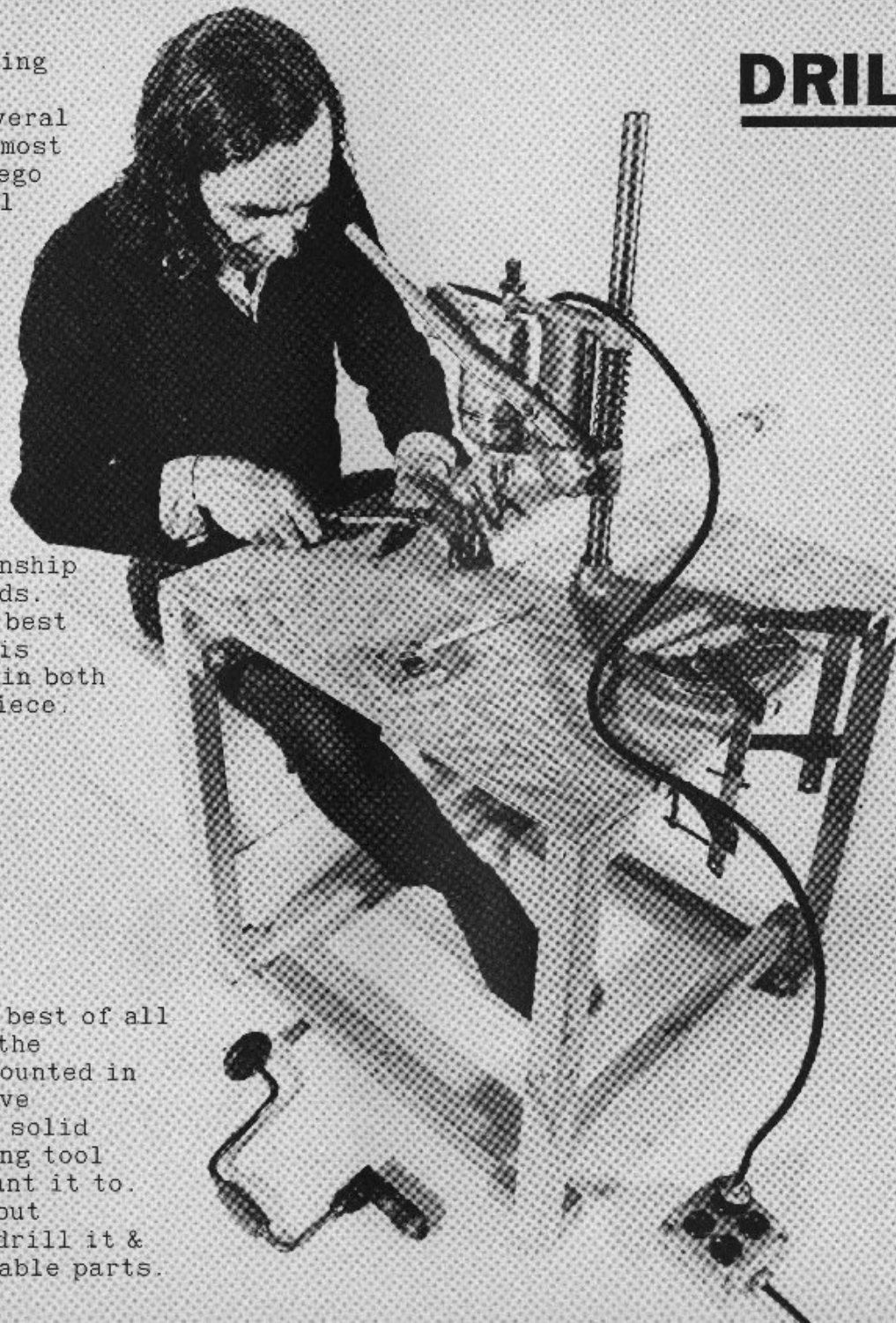

## DRILLING

CAUTION/i wouldn't encourage anyone to use the electric drill held free hand. the entire event just moves too fast for accuracy. after watching a lot of people try it. i don't think a Dalai Lama who was also the best Porsche engine rebuilder in Iowa City could handle it. the only next tooling level down is the old-fashioned hand brace with a wood auger. they are tall & you can quit drilling now & then to sight them for verticality from both main directions. the hole progresses slowly enough so it doesn't get away from you. the big chips exiting the holes are very satisfying & beautiful. you're in a Durer woodcut. the feeling that no electric power is involved is very positive.

ACCURACY/layout & marking are of primary importance in getting fine results in building. the working of wood & carpentry has acquired a kind of stopgap cobbler's approach as if fine work could not be done with wood anymore. in some golden age in the past, yes, but not now. the surge of industrial production using metals in this country in this century has somehow blunted our approach to working wood & we assume that the results will be crude. the truth is that with reasonable care even the soft woods can be worked to very close tolerances.

THE SHARP PENCIL/make sure you are using a good sharp pencil with not too soft lead when making the cutoff lines for sawing the 2x2's. when you mention wood, some well-meaning clown shows up with a carpenter's pencil that has lead as big around as a Pepsi bottle & is terribly proud of his tool choice which he bolsters by saying "carpenters use it, don't they?" i use a 4H drawing pencil sharpened with a fine file to a sharp point. you may find it better beginning to use a No. 2 pencil with eraser. it'll flatten out as you mark with it, so make light, accurate lines & sharpen it from time to time.

## ACCURACY

SAWING SQUARE/one good approach to sawing the ends of 2x2's square (so the end plane is perpendicular to the long axis of the board) is to mark 3 adjacent sides of the piece for cutoff with the combination square. make a shallow sawcut along each of these lines before turning the middle marked side up & sawing in the ordinary manner. hesitate periodically to check if your cut is within the limits established by the first shallow cuts. just keep making sure you are remaining in the plane of the cut. try to establish that plane in your mind & really feel the paths of the handsaw in relation to the ideal plane. cut slowly, not pressing too hard because the tool isn't a steak knife, it's a saw. probably this attitude about cobbling when using wood seems to cause us to attack the piece viciously & hurry, hurry to separate it. most of us seem to use handsaws like we are killing the werewolf. the way of precision & results which give inner satisfaction when working wood come in stately rhythms. the way is not jump cuts.

EXPERIMENT/a good way to open up any operation which is new to you (or that you have done before but with unsatisfactory results) is to experiment on a scrap two or three times before committing your good material in the process. in this way one can improve the technique & act with assurance & confidence, avoiding the ruining of materials, waste & the attendant guilt & negative emotions. i always cut off the mill (existing) end of the 2x2 because it might be slightly damaged or rough. the better lumber mills usually seal this highly absorptive end grain with a wax or coding paint. it seems better to make your own cut & have it consistent with all your other cuts.

DOING IT/OK, so mark a 24" length on one of your 2x2's. cut with the handsaw about 1/64" to the right of your line. that is, leave the line showing after your cut is finished. this provides a guide later for rasping the end square. also it never seemed smart to me to obliterate your guide line as you go because this prevents referring back to it to see how you are doing. if a surveyor worked without leaving stakes behind him at the principal intersections of his sight lines he would lose his frame of reference. so will you if you are sloppy & cut through the layout line. use the master to mark your other pieces (marking from the line, not the cut). better saw after marking, then mark then saw. that way no trouble with the saw kerf.

DETUNING/keep in mind that you are trying to beat the enculturation of mindless hurry & try to ease yourself deep into this sawing like the old hippo in the mud in the Tarzan movies. get sensitive to what's going on. it's a whole new world of phenomenal events on a different scale. body stance, position of the head. good firm spot to rest the piece on (at an unstraining height between 18" & 24" from the floor) are all components which have the sawn face as a resultant. bad luck doesn't figure here. if the face comes out perpendicular to the long axis of the 2x2 fairly cohesive in plane it is the result of having all the forces distributed in the right places.

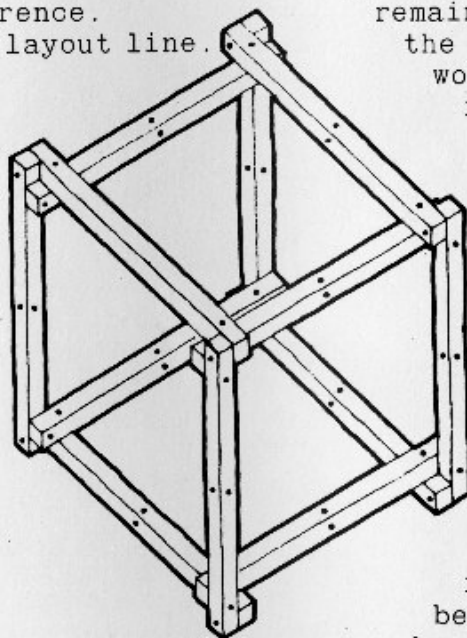

USING THE RASP/now use the four-in-one rasp to smooth & improve the relationship of the sawn end to the other planes of the 2x2. i do it with the piece in the same position as sawing, holding it down with my left hand & left knee, working the rasp with my right hand. it seems important to rotate the stick as you work as this sort of cancels out the massive distortions everyone seems to get when just working in one position only. the original pencil marks remain to work from & you can help by imagining

the ideal plane you want to achieve as you work. this influences your hand. use the flat fine side of the rasp mostly until you get hip to the tool's way of life. the rough side really grooves & eats up the wood so you want to gain some sensitivity before unleashing it. try to work from the edge near you to a little past the middle of the end face. sometimes the rasp will splinter the opposite side if your stroke is too long. since you are working from all sides rotating you will pick them all up in sequence. try to think flat.

the general tendency is to round the end with a loopy stroke of the rasp.

if you concentrate & stick with it you'll be surprised at how much control you can develop. one of the old Englishmen who started Rolls Royce was so good with a metal file that he could put a piece of round stock in a vise & file 6 flats on it to make a hexagon within dimensional variations of about a hundredth of an inch. just with a hand tool without marking or laying out before. that's real concentration & skill. more important, it must do something really great for your head.



ALWAYS wear goggles when you work around power tools & hazard operations. you've got to keep your body as whole as you can.

IMMOBILIZING THE 2x2/place the master 2x2, with hole centerlines marked, in position under the drill. prepare three small triangles (or squares) of plywood with one perfectly straight edge & two 1" brads (small nails) in each one. lower the drill to within 1/8" of the centerline cross marks so the relationship can be evaluated & move the master around until the hole nearest the end is centered under the bit. tack two of the pieces of plywood to the baseboard along the back long edge of the 2x2 (about 5" apart). make sure you're holding the position & when it checks out take the third block & nail it in as an end stop for the 2x2.

YOUR PERSONAL INDUSTRIAL REVOLUTION/you have just built a simple jig. shades of Henry Ford, Arkwright & James Watt. at long last a citizen is able to take direct advantage of a simple but outrageously helpful technique of the industrial age. most often these techniques have been used to make a hip few rich while the salesmen & interior decorators have exhorted us to love irregularity of form because by doing so we somehow express some uniqueness about ourselves. simultaneously, those guys were proving all too conclusively that a cornucopia of plenty can be built by observing regularity & fidelity in the structuring of material objects.

DOING IT/anyway, go ahead & drill all twenty-four end holes. have care that these holes are kept parallel (in the same face of the 2x2, that is) when switching ends because that's sometimes a problem. all holes are made with a 5/16"-diameter bit. since 1/4" bolts are used to assemble, these holes give some tolerance (leeway) when bolting. beat the negative of splintering on the underside of the 2x2 where the drill bit comes out by always holding it in contact with the baseboard.

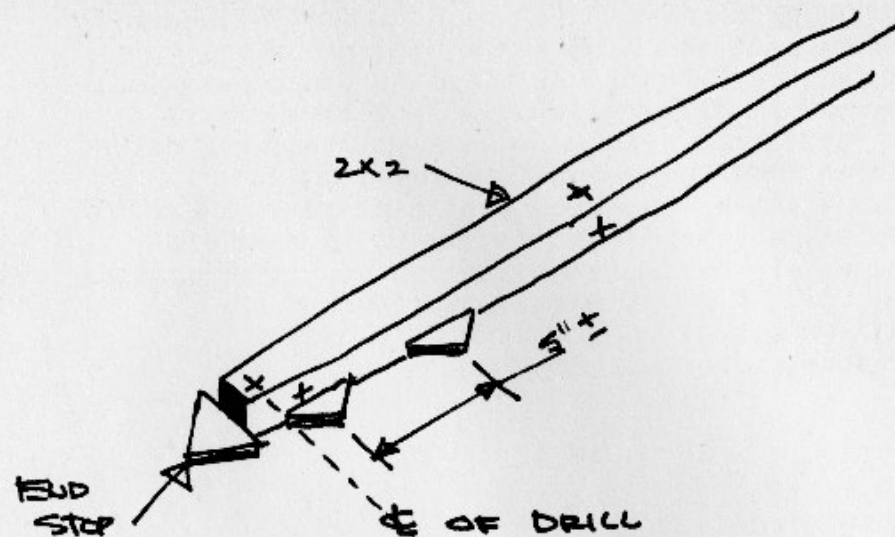

CHECKING & DETUNING/spot-check with measuring tape from time to time to be sure the blocks or drill or stand have not shifted from the kinetics of use. as to approaching the actual pulling down of the handle which causes the bit to travel through the wood—it's a similar proposition to the handsaw. give the tool time, let up on the handle if the drill packs with wood fragments & slows down. our general tendency despite the powerful myths of American know-how are to hurry, hurry & end by almost punching the bit through the wood. this causes splintering when the drill leaves the wood & it is negative. reset the end-stop block properly for the second pair of holes from the end. drill, then reset for the center holes. now you have fabricated at least 12 beautiful universal members with 2 or 3 spares from the fourth 8' piece. if you're human there's no sense in discussing sanding & finishing at this point because the big charge now is to assemble the structure & see what is.

FASTENERS/to erect it you need bolts. if you don't already know one, pick out a hardware store. not just any one will do these days because most "hardware" stores seem to be appliance stores (or something) with lip service to the original idea in the form of some Taiwanese tin foil tools & top-heavy racks of blister-packaged screws & bolts. nothing will convince us so completely that we are in the twentieth century as purchasing four tiny bolts & nuts cleverly imprisoned in a little chrysalis of cardboard & plastic for some ridiculous price.

# HARDWARE

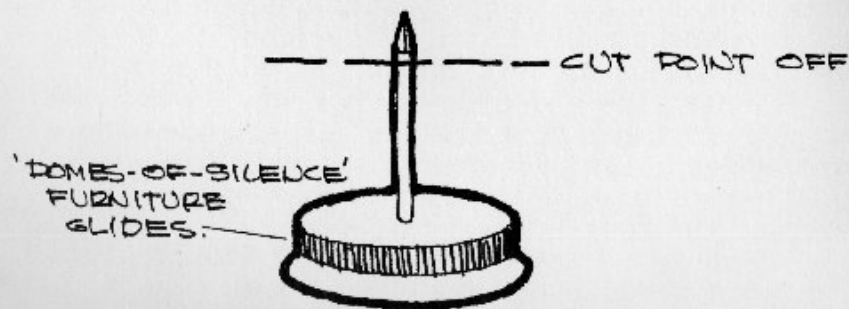
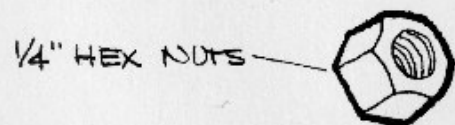
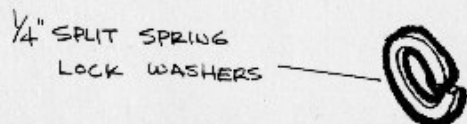
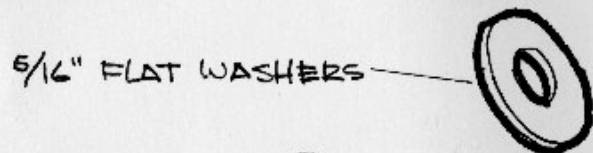
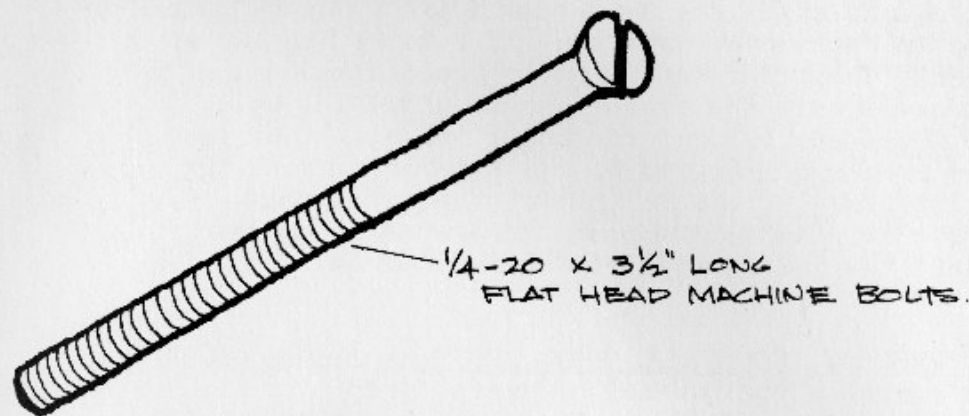

IDENTIFYING A REAL HARDWARE STORE/look for the old-fashioned hardware store where the clerks are grim as deacons since they are the last guardians of scarce & arcane products. if the guy puts your bill in a little cannister, twists it onto an overhead carrier that looks like a long-span ski lift, & shoots it to a little crow's-nest mezzanine in the upper back by pulling down vigorously on an overhead rope that's a good sign. if he exhibits the generous but icy civility of a vatican diplomat upon hearing your order, you have scored. just hope they never go out of business.

QUANTITY BUYING & SPECIFICATIONS/depending on how much you are moved by this trip so far be aware that you will pay through the nose for relatively small quantities of anything. we are committed so we buy in larger more economical amounts. at least in packages of 100 units, which generally has more favorable pricing. be sure all the hardware you buy is brightly plated (either zinc or cadmium). raw bolts & washers will rust quickly just from the humidity in a house.

# ASSEMBLY

PUTTING IT TOGETHER/find a fairly level surface & assemble the two opposite side frames of the cube. the bolt heads go outboard of the unit, all nuts & washers inside. just hand-tighten to start. get her all together then wrench-tighten one corner at a time. when you use the wrench, draw the bolt heads slowly into the wood until they are flush with the surface with no splintering. make sure faces of adjacent members are flush before tightening. this will help the whole square up. when all bolts are secured, turn the unit upside down & gently tap the glides into the center of the vertical members. remember to cut about 1/8" from the nail point so it doesn't interfere with the bolt. your analog is now weight-supporting & ready to go to work for you. if your projected use requires a top, cut a 24" square from a scrap of 1/2" or 3/4" plywood & bolt it in place using the midpoint holes in the two top horizontal members.

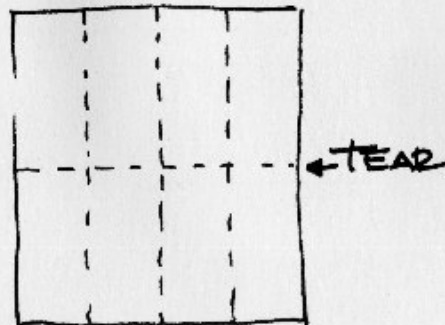
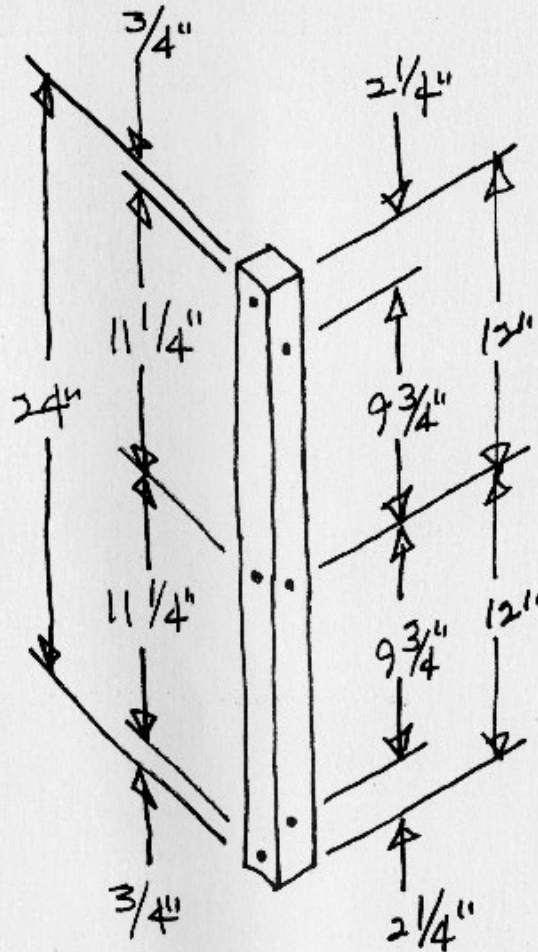

INTERCHANGEABLE PARTS/industrial production has always depended on the many advantages coming from the idea of duplicate parts, fabricated with minimum variation. we can get profound beneficial results, as individuals, from this concept. anxiety levels are lowered in building & standard members can be recycled with great ease because they haven't been so specialized either in design or by eyeballed inconsistencies in making.

SANDING & FINISHING/cut a sanding block from some 2x2 scrap. make it 4" long. instead of ordinary sandpaper we use 3/0-120 C-wt. open coat aluminum oxide production paper. tear it as shown & it will just wrap up the sides of the sanding block. three coats of rubbed linseed oil or a penetrating resin sealer like Firzite with sandings after each coat makes for great smoothness & durability.

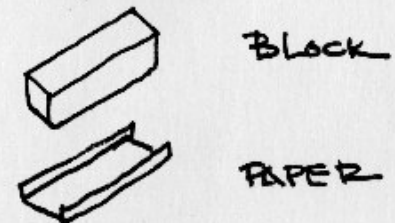





LIVING STRUCTURE/this is our Matrix in Chicago from the front door. a Matrix is a group of mobile space modules like 3-D graph paper that you live in & around. it is a new way i discovered that makes better furniture & houses than the old methods. but more important than "better" is that it makes real homes for our time where you can feel content & just.

# NEW SLEEPING LOFT

THE NEW FREE-STANDING SLEEPING LOFT/marshaling long arguments in favor of the sleeping loft right now is about as gratuitous as paperbacking an eskimo edition of Sir Francis Bacon's early food-refrigeration experiments. the loft bed is so nifty & exciting to retire to & makes so much sense spatially that it is even rumored that politicians use them. sleeping above floor level frees a large area of the room for other uses. the traditional static world view plops a monster BED down in the middle of a room & forever after that room is a bedroom. it doesn't even matter how big the room is. traditional beds, space-eating monsters hunkering on the floor, are such a presence that three of them could crowd the Astrodome. we are just getting onto the fact that what we can really use now are multifunctional spaces which can be camera workshops in the morning, rehearsal halls in the afternoon, friendly restaurants in the evening & sleeping areas for only about six hours late at night. space is too precious to be limited ritualistically to single functions.

PROBLEMS OF THE SLEEPING LOFT/despite the recognized & obvious advantages of lofts, two obstacles appear to rule out this delight for a lot of people: not everyone is lucky enough to have the high ceiling usually required for the sleeping loft, and most loft beds involve fastening the structure in some brutal way to the landlord's walls, floor & ceiling. even if your landlord is a regular St. Francis & doesn't mind, there is still a hangup for you. the heavy members & mean fastenings represent a heavy investment in moving matter through space, lag screws, star drills, molly bolts & falling plaster. you do all this monster with the salvaged railroad ties & bridge bolts then twenty minutes after it's in place you discover your karma demands you split for Oregon. we all believe in the worth of the experiential life process but the bee who never gets any of the honey is being shorted.

# FRIENDS

marty

chance

ron

lou





THE LIVING STRUCTURE IDEA/this mobility problem & the height problem were two of the heavy ones i thought about when first developing the Living Structures back in the early 1950's. we retripped on that when i came out to Chicago in 1970. some guys at the university there thought it would be a good idea if i came out & talked with the architectural students there about building Microhouses & living in them. i was yo-yoing around New York City then & had just finished four months doing a thirty-six-slide projector environmental structure for a Broadway show. i was also gently helping a major furniture manufacturer butcher some of my Living Structures. he had the fond hope that if they could be made to resemble sofas & credenzas then the idea could be exploited for money. that didn't work so great & i noticed that casual hostility was reaching new highs in Gotham that summer. my arguments with cabdrivers & newsstand guys were increasing in tempo & frequency so i thought, why not go to Chicago?

## LIVING STRUCTURE

CHICAGO-LATE SUMMER 1970/i went & it was good. the sweet winds from the lake felt good on the skin & the sun sparkled so bright you felt like living forever. i met a lot of really noble people, inside & outside the university. the school people seemed sincerely interested in the students as persons & it looked like a place which might become a real research node for new ways of living on Earth. outside the school i met vickie, who may still succeed in making sense out of the present voodooism of nutrition & physical therapy. i could breathe almost as slowly as peter, a fry-cook-saint close to peace of mind making the long journey from being a Canadian biker with a busted back to doing something with the land. his lady, judy, was a deep earth person who could probably do up a Pacific sunset in a mason jar & play it back to you next winter. she came with a little boy named thys who once sanded two old painted-up drawing boards with me. i watched & learned much about intensity of concentration.

THE STUDENTS/carole helped me that first year in the beginning architectural class & we really connected with the people on a new basic 48"-cube module that was superflexible. before leaving New York i'd spent twenty-nine seconds thinking about something to build with them in Chicago & a structure like that sounded good but i wanted to work out with the students, not just lay it on them like john & the Magna Carta. so we went through a whole process which was pretty legit & ended with our group producing fifty units. each guy in the group used one as his own to study, sleep over in & store his equipment.

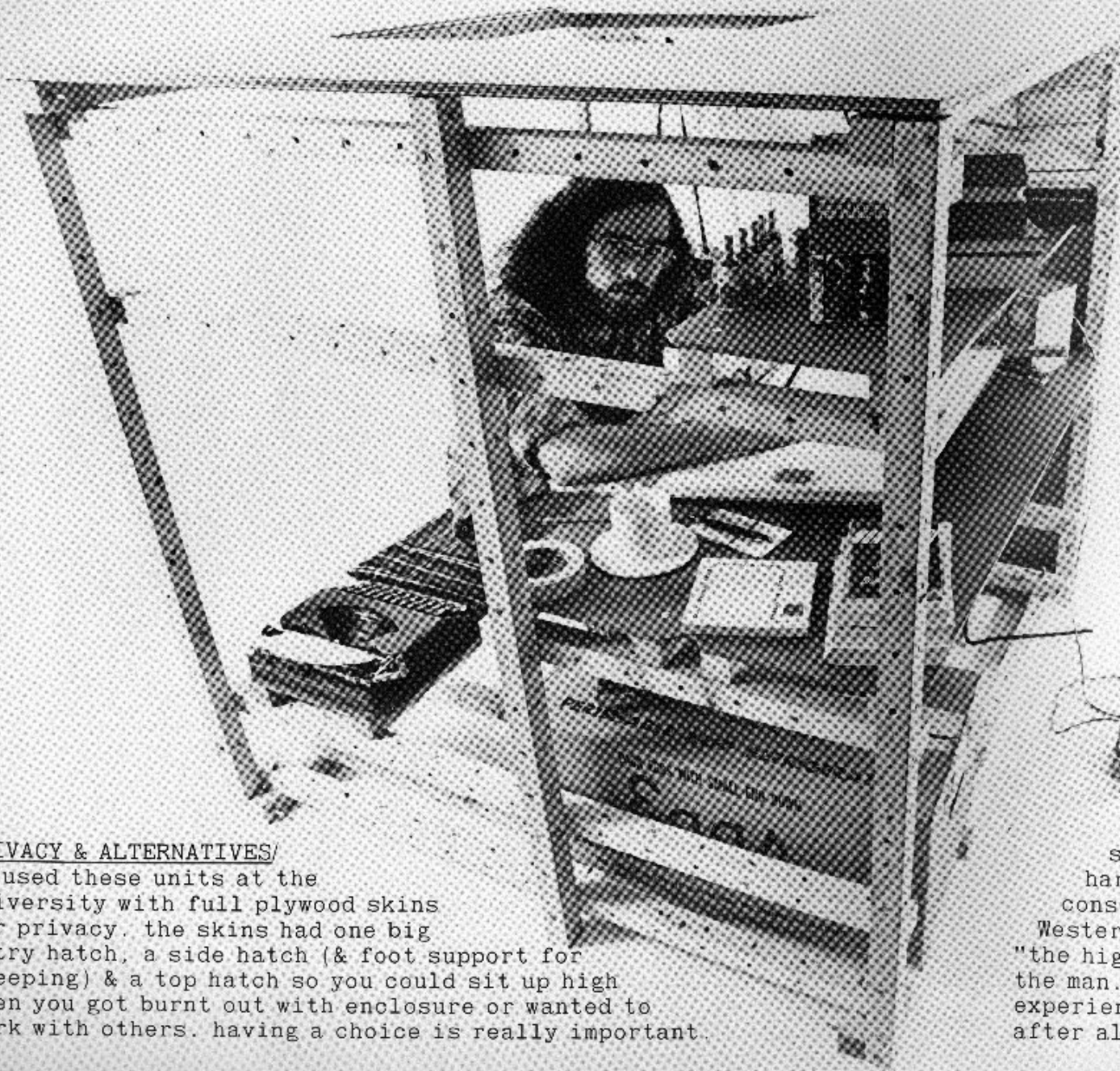

#### PRIVACY & ALTERNATIVES/

we used these units at the university with full plywood skins for privacy. the skins had one big entry hatch, a side hatch (& foot support for sleeping) & a top hatch so you could sit up high when you got burnt out with enclosure or wanted to work with others. having a choice is really important.

#### DESIGNING THE SPACE MODULE/

always, when you work on a new thing, part of that work takes place in terms of "what is," although most of it involves what you believe or think "should be." so to some degree the 48" dimension was a function of the fact that lumber & plywood are milled & produced in sizes relating to that dimension. but more important that choice results in a unit which allows you to get the sleeping surface elevated with space for study, lounging & storage in the liberated space underneath. all this will fit into the most frequently found 8' ceiling height. these units are independent of walls & ceiling & can be moved about the room. they aren't anchored to one static arrangement. they are easy to knock down, move & erect in a new place. the movable pack is compact & the structures adapt to different rooms pretty nicely.

some guys took the 48" dimension sort of hard, but i think it was because their consciousness was still atrophied at the Western-European ego-tripping level of "the higher the ceiling, the more important the man." after you get into it physically & experience it fully, these fears disappear. after all, you can't stand up in a Ferrari.

charley



HOW IT WORKS/the inside equipment system includes the seat, worktable & shelf. these are all made of flat planes of hardboard stiffened by 2x2's underneath. we call the planes "pallets," because of their form & load-carrying functions. in principle they work like industrial skids which support stacked cartons or boxes. the pallets span the width of the unit & rest on pairs of horizontal 2x2 rails which are part of the skeleton. they are not bolted down & can be moved easily from one level to another as uses change. the seat slides back & forth so you can find the best position for you.

SKIN/we used exterior plywood for the skin because the general quality is better in the veneers & the adhesive. sometimes i wonder why the mills continue to make interior grade plywood. there's nothing sadder than a piece coming apart & de-laminating when exposed to dampness. exterior grade plywood is sure worth the money. there was a slight hook here because i wanted to broaden the use of this structure & experiment with using it outdoors at Groveland. just as a matter of principle it seems positive to design & fabricate stuff which is fundamental enough to apply to a number of situations. this is what God seems to have done when making matter in the universe. exquisitely simple. fit-anywhere components combine in many ways to produce richness & variety. this may be what is meant when "organic" is used in connection with architecture.

**OUT**



48"-CUBE MODULE AT GROVELAND/that first summer chuck & lou came down, they combined their individual cells & raised them off the ground on tetrahedrons. they roofed the whole thing with polyethylene over a ridge rope between two trees. one unit was for tools & gear & the other made a great chamber for a Thetford self-contained toilet. when using it you could look out the foot hatch & feast the eye

on gentle hills sloping down to the Illinois River on the west. the overhead hatch was spacious & handy since you could stand up to adjust your clothes. chuck & lou put air mattresses on top & slept under the poly-filtered stars while they put up an 8' Microhouse for more permanent quarters. but they still use one module for the Thetford unit.

# MATRIX IDEA

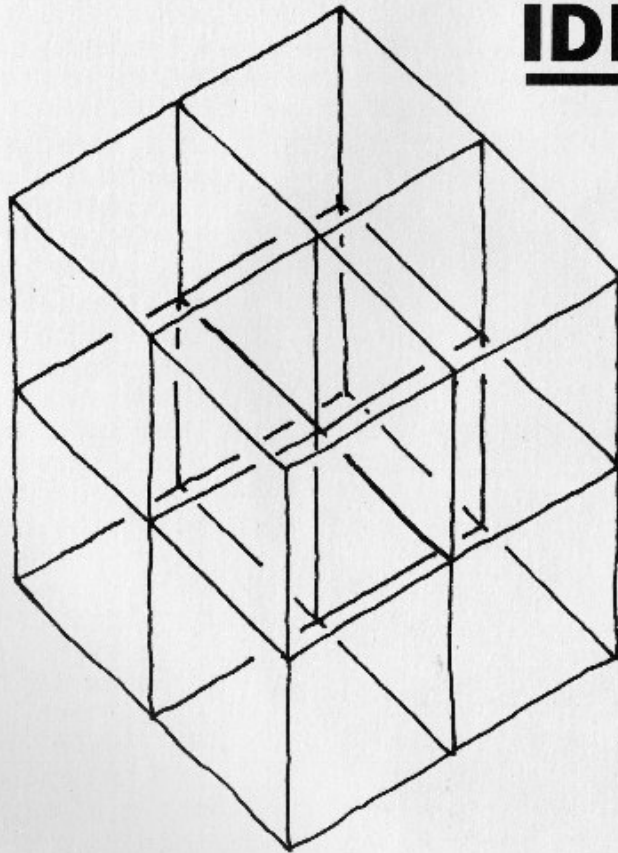

THE "BLUE BABY"/last year our group at the school combined eight of these modules to make an 8'-cube Microhouse, elevating it off the ground on tetrahedrons.

this was a comprehensive application of my Matrix Idea using multiple cells. it is like a medieval alchemist's dream. we took simple universal components & aggregated them. it could work in a larger size too. the pallet arrangement in this one was complex but workable & supportive of the activities of working, cooking & sleeping. since the pallets can be rearranged without tools, it is truly responsive to changes in the life pattern of the person. some change from the ritualistic design patterns of the past which lacked mobility & were locked onto a fixed pattern like a dead bulldog's jaws.

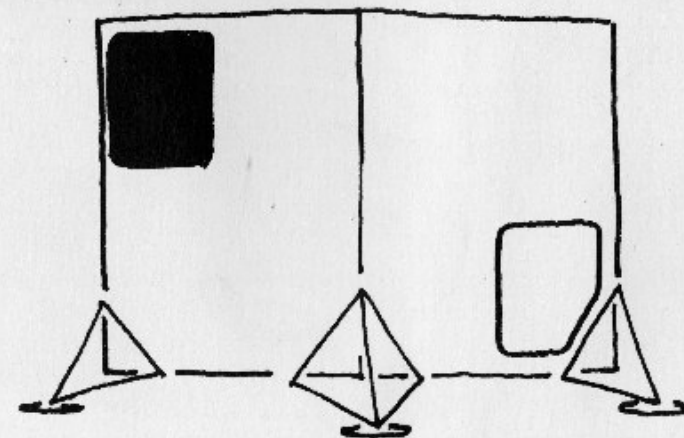

ECOLOGICAL RESULTS/the Matrix Idea presents a very different reality in terms of recycling materials. traditional design & fabrication techniques specialize & shape materials so particularly that to reuse the only way is to apply power to break it down then reconstitute it. in using the Matrix Idea we keep parts general, universal & all-purpose: when needs change & situations change the response is to alter the assembly relationships of these parts. thus very little power & effort are involved in adapting to new conditions.



OUR MATRIX IN CHICAGO/carole & me needed some frame of reference to live in so we built four of the modules for ourselves & used them in an old North Side apartment. the initial design was separated into two main assemblies, the skeleton & the skin. for our use we relied more on the skeletons to preserve air circulation & openness. we didn't use the skins

much because there wasn't the same privacy issue as at the university. the top is 96" square so it makes quite a handsome sleeping & lounging surface. the area around the foam mat is used for books, study stuff, toys, models, it's more like living to wake up eye to eye with flowers or a toy than the usual view of the old bedside table with alarm clock, sleep pills, telephone & all the other tools of alienation.





3-D LIVING/Living Structures are a way for close people to be close in a single space without getting in each other's hair. the level change really does it.

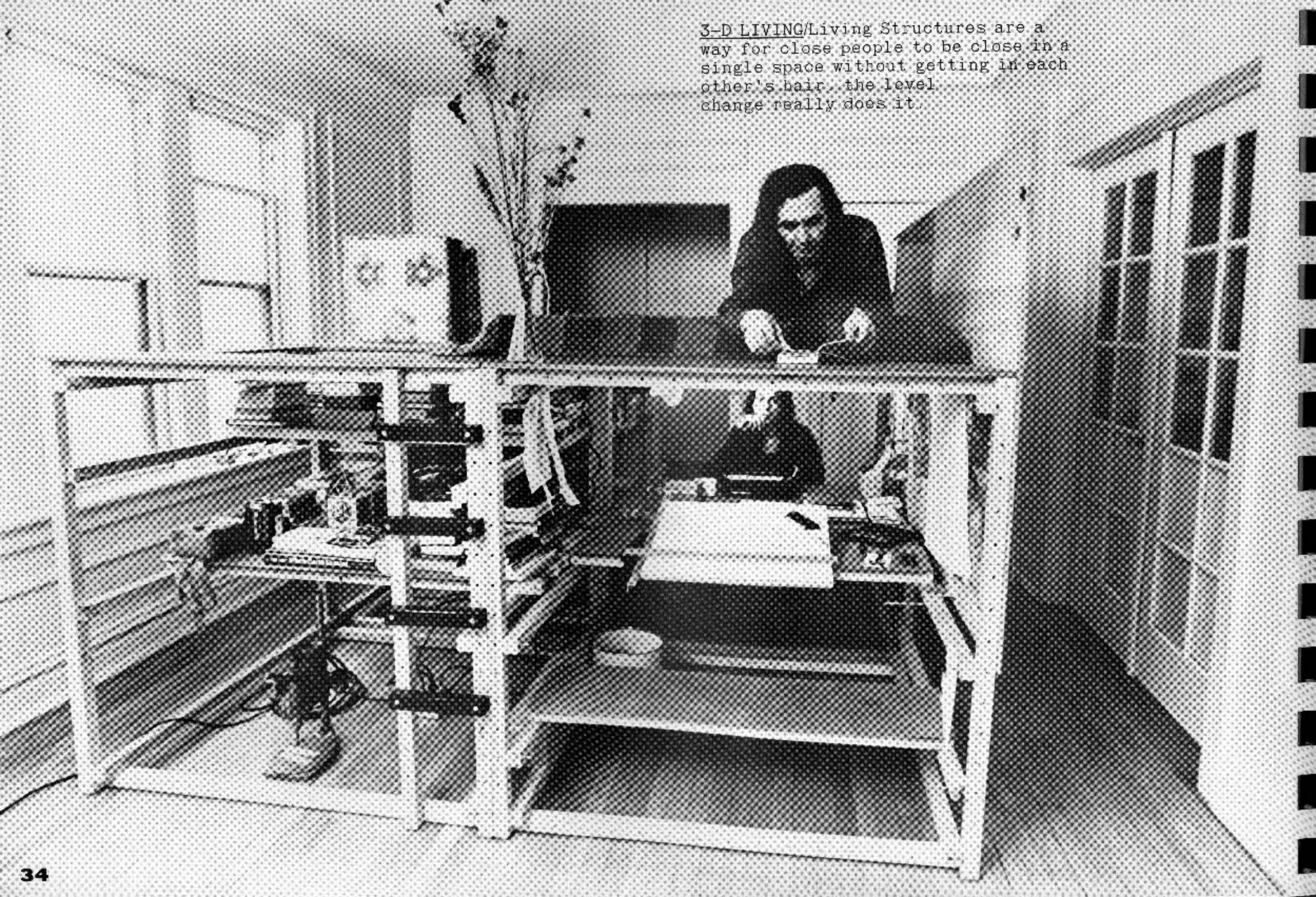

HOW TO USE IT/we had the system set first to provide each of us with a study, cosy & contained on the low level. these areas convert easily (no tools) to extra seating or sleeping surfaces. we used these spaces face to face, which translates & aids our active collaboration. it also feels good. the underspace of the third module was used for clothes storage. if you don't already know, get on with the fiber containers that bulk ice cream comes in. a lot of places wash them out & give them away when empty. great for holding clothes (or almost anything). we don't use much clothing because it doesn't seem to make us happier or more at peace to have a lot or a big variety. actually the effect is very much the opposite. i guess if i wanted to spend a lot of time caring, cleaning & nursing clothing, i'd have become an English valet or a tuxedo-rental guy in Cleveland. carole just wants to simplify the supporting stuff like clothing & really focus on study & development. not a bad idea.

STORAGE/the fourth module was our Information Bank with small cassette recorder, slides, books & papers. you can notice there is a lot of uncommitted space in the storage cells. if you are media-conditioned you will tend to react strong negative to this, but if you think a minute it's possible to realize that the fashionable (tyrannical) idea of "efficiency" & "utilizing all the space" has such built-in disappointments. say all your space was used "perfectly," then a friend gives you a packet of sewing needles but there won't be anyplace to put them because by axiom all the space has already been exploited. the old farmers knew that good living on earth was based on careful use of their space but also maintenance of a portion of it open & fallow for expansion, changes or unforeseen happenings. the current societal notion of efficiency as total consumption is unbelievable & unlivable because it is so static.

LIBERATED SPACE/traditional furniture was never organized as a whole system. the pieces were a bunch of separate, unrelated objects determined by inertia & sentiment. feeble efforts were made to organize them "visually" but that was just another trap. the old culture has always tried to make the unworkable endurable by overlaying it with whichever "good taste" is going at the moment. unfortunately this is like trying to make airplanes look like birds. that never worked either. that's because you can't make feathers out of aluminum. Living Structures work with interpenetration of spaces & systematically, geometrically get more performance from a smaller array of components in a more cohesive area. away from room walls they aid circulation, movement & cleaning. one of the most profound results of the Living Structure synthesis is that it frees a larger part of the space in any room for open & inventive uses. you have room left over for tearing a motorbike down, gallery-mounting pre-Columbia sculpture collections or restoring great-grandma's Singer sewing machine. in a traditional "living room" all these activities would not fit in very well.

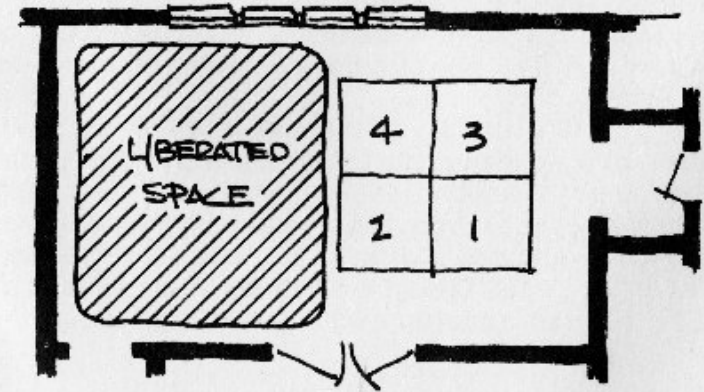

**LIBERATION**

BUILDING IT/this Living Structure is real easy to fabricate. it's just bigger than the 24"-Cube Module. the main skeleton is made from universal members 48" long. the increase to 48" members will influence your lumber-picking techniques. you have to be a little more observant in selecting the 2x2's at the yard because warping & torquing distortions increase in seriousness with longer pieces. length is critical. check the raw pieces for actual length. cut length at different mills varies between right on 96" & 96 1/4". those pieces just over 8' enable you to clean each end & to do the center-cut ending with two 48" pieces. this won't happen if you cut an exactly 96" piece into two parts because about 1/16" gets converted (& lost) to sawdust & your finals will be short. watch out for pieces which are only 95 1/2" long. it makes waste not to check & know.

MEASURE/because the 2x2 cross-section remains the same, the pairs of holes at each end are located just like those in the 24" cube. the additional holes allowing more flexibility occur every 3". the best way to tool for these is to mark with pencil the 3" intervals along each of two adjacent faces of the 2x2. then use two locating blocks nailed into the plywood baseboard under the drill stand to position the piece so holes will be for sure on the longitudinal centerline. the blocks plus getting the mark under the drill every time will result in good accuracy if you don't hurry & blow it. you could eliminate this marking & jig that part of it but the jig would get pretty complicated & time-consuming.

STIFF UPPER LIP/try not to get funky & fade doing these holes. there are so many that a person just naturally wants to quit them & go home to mother. it isn't even that you will use them all, all the time. it's just that when you do need them they are dynamite. also if the holes are consistent, it is truly a standard universal member which can be placed anywhere in the structure.

## UNIVERSALITY

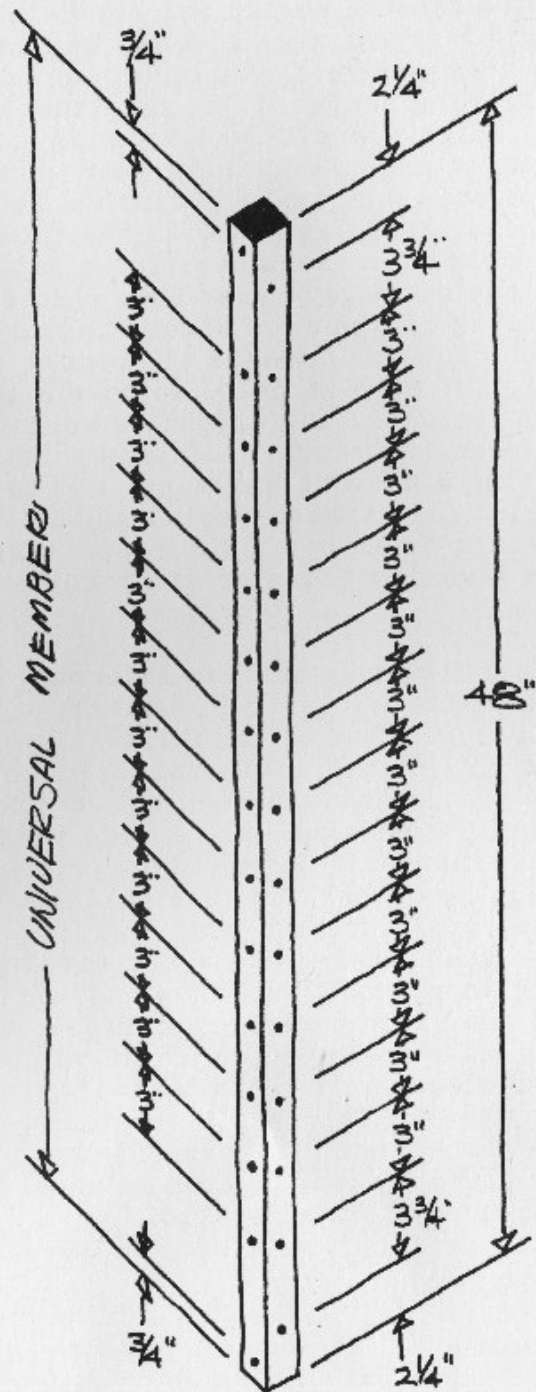

# PALLETS

MAKING THE PALLETS/the pallets are made from 1/4" hardboard. sometimes it's called "Masonite" after one of the earlier producing companies. it is a hard, durable & dense reconstituted-wood product made from fibers which are either waste from other cutting or trees which are not suitable for dimension lumber or plywood. avoid bargain hardboard & the superexpensive. medium-priced stuff is good because it is a highly competitive market. check out the stack yours comes from to be sure it's been kept flat. sometimes the piles are resting on 4x4's or two rough skids & the crazy warps go right up through the pile. always seek the material that has been stored indoors in preference to that which is just under a shed roof with open sides or completely in the open with poly taped over it. look at the edges to make sure the steel strapping used to bind the packs for shipping hasn't dented or chewed up the edge.

CUTTING HARDBOARD/some of the resin binders & filler materials used in this stuff are unmercifully hard on tool edges but it does cut to a fine precise edge. if you are onto the handsaw use the fine flat section of the four-in-one wood rasp to smooth the tooth tracks out, then finish with block & sandpaper.

FINISHING/Firzite or boiled linseed oil is a good sealer. dilute the oil with a slight (1/2 tsp. per cup) amount of pure turpentine for penetration. be sure to wipe off all excess oil. be mature & cool & finish before assembly, sanding between coats. the usual superhype script in our society is to bang out the members & be in a hurry to assemble to see how it hangs. then it's too much hassle to disassemble, finish & re-erect. if you try to finish the skeleton when it's together the sanding & sealing is not complete on all surfaces & you get runs & drips. it's like an adhesion of your internal organs. try to do it the adult way. taking these units up & down is good for your head anyway. it makes you believe in your own reality.

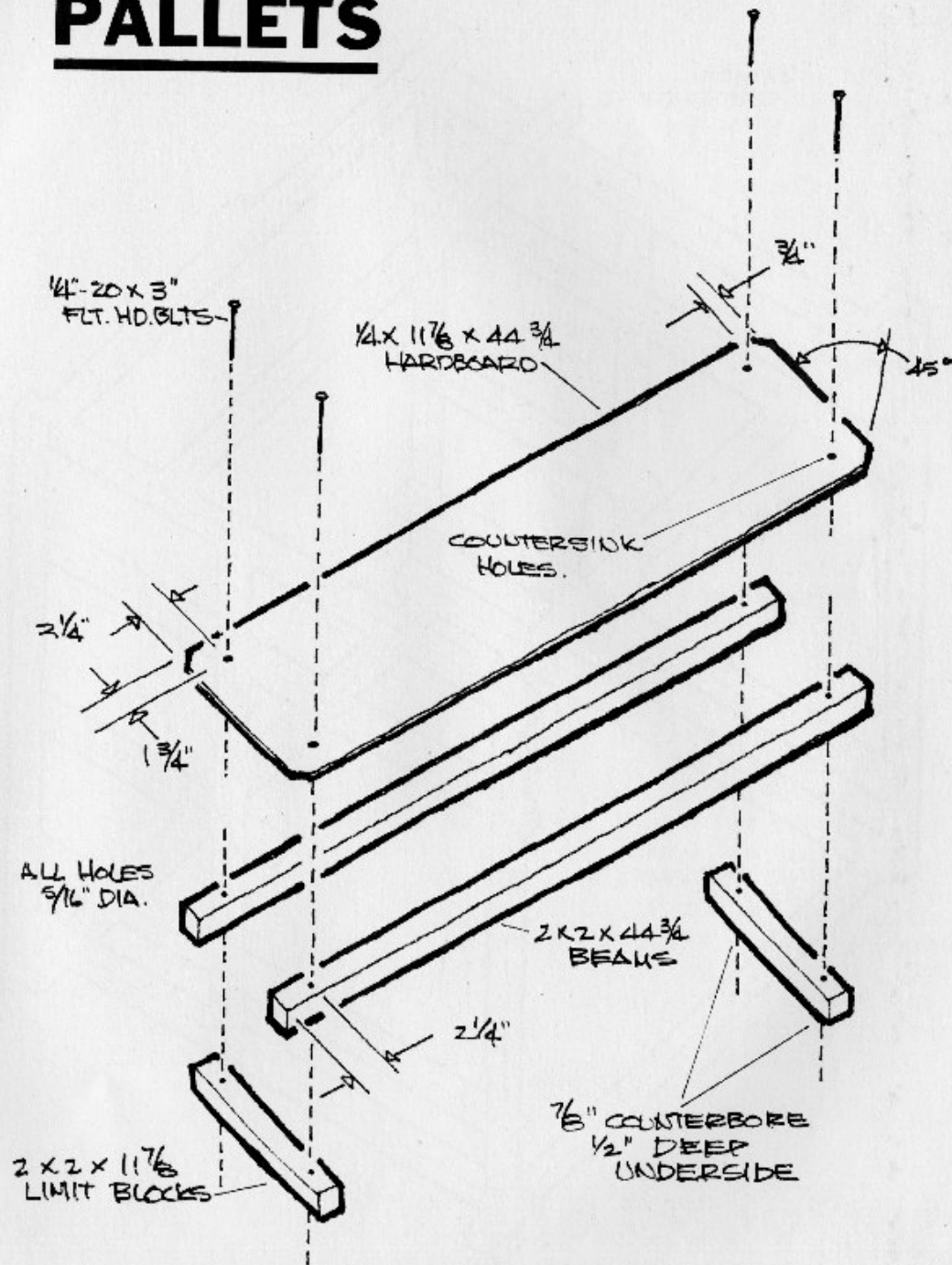

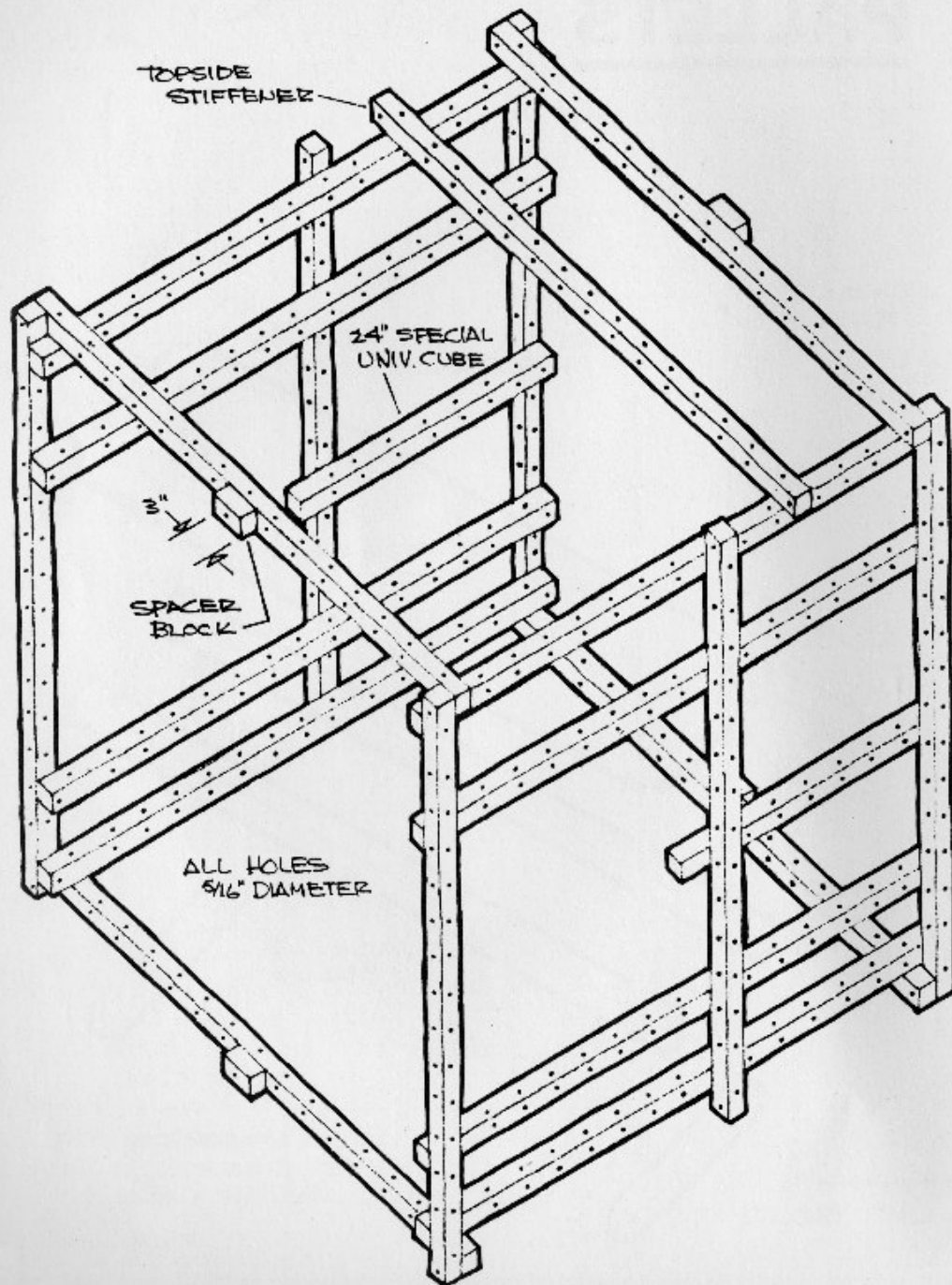

DIFFERENCES BETWEEN UNIVERSITY CUBE & OUR MATRIX/one 48"-cube module for the loft requires 12 universal members for the basic skeleton, plus 4 or 6 more depending on what you do inside it. one additional member should be used under the topside panel to stiffen it. if you need a 48" module with the skin for a study area, child's domain, at-home office or privacy space, there are some slight deviations from the pieces used to make the loft. the main difference is the pair of 24" members supporting the pallets at the table level. these are used instead of 48" members to allow use of the foot hatch. it's pretty neat to retain this feature just in case somebody wants to fall out & lie down. good for a kid or an extra visitor.

SPACER BLOCKS/note the use of the spacer blocks to insure against the skins warping. this is good to do no matter what thickness plywood you use, to keep the skins trim. because the side skins are initially bolted just to the vertical skeleton members, the top & bottom panel edges are unsupported & unbolted unless the blocks are used.

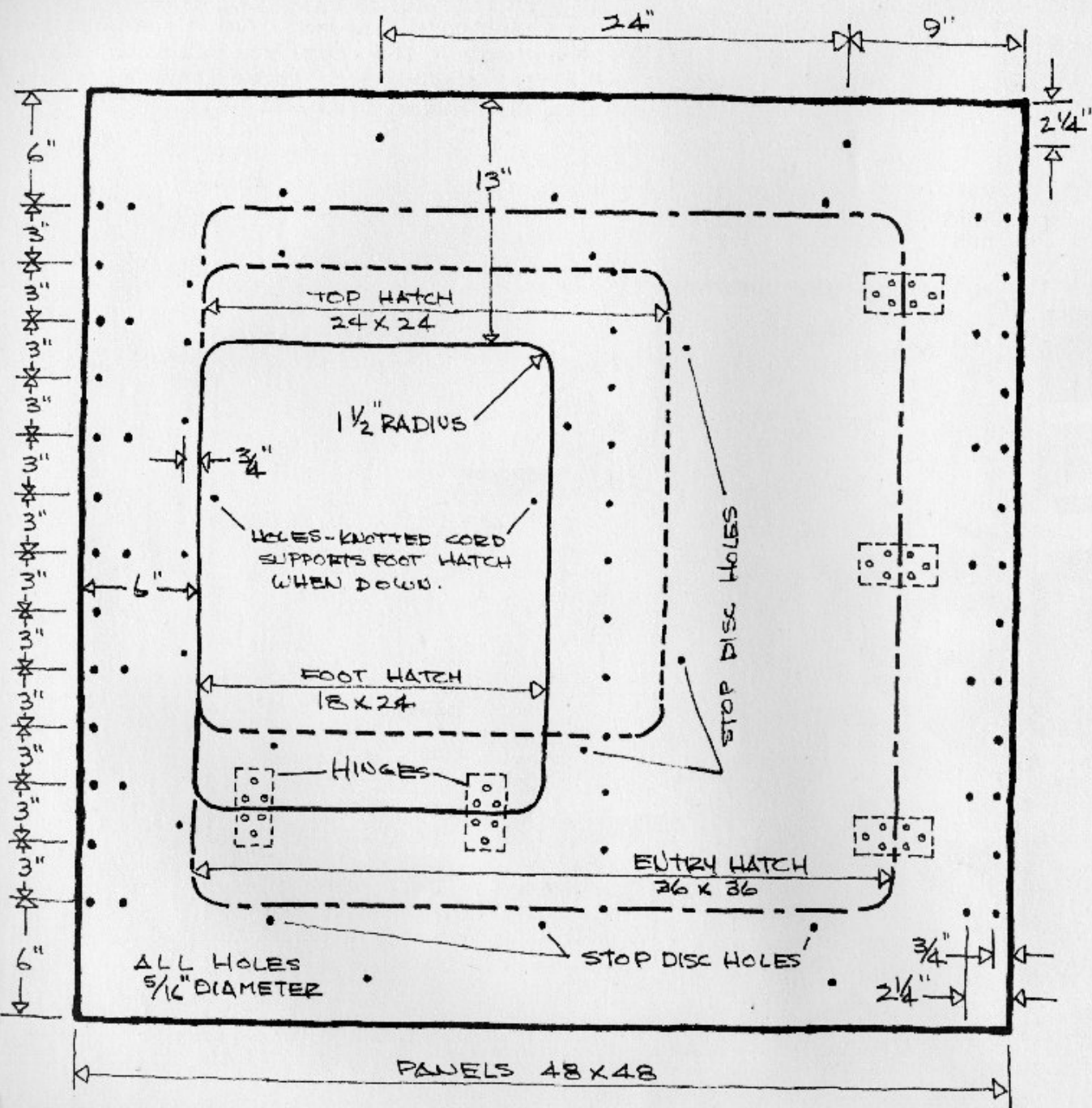

MAKING THE SKIN/this drawing incorporates all bolt-hole patterns & all hatch dimensions. select from it for the combination you need. evaluate plywood as you would hardboard. see the stack it was in. check that it was under cover & flat. don't accept a piece with dinged or shredded edges from bad handling. the skins require full 48" squares. try for grade A-C but check on A-D just for price' sake. sometimes the D sides aren't too bad. a few artistic knots didn't stop the old Japanese & added a lot to what they did. 3/8" thick is fine but you can use 1/2" for extra muscle. avoid the lumberyard where the people are on some kind of laissez-faire fantasy trip in pricing. some yards are amusing themselves putting up crazy prices just to see how far they can go.

BOLTS, HOLES & HATCHES/use 4"-long bolts to secure skin panels, countersinking heads in faces (see p. 93). we put a generalized hole pattern in the skins so they'll fit anywhere. mark & lay out these holes carefully. designing flexibility does no good unless the making is good. use master, clamping panels together & do several at a time with the drill stand. for layout you need a long straight-edge & a good one. a T-square or metal rule is fine. yardsticks are no good & neither is the wood-butcher's dream of jauntily picking a semistraight piece of scrap that happens to be nearby & drawing along it. one good bet is to have a friend with a good table saw (fine-tooth blade) cut a 3"x60" piece of hardboard perfectly straight. don't sand it a lot & make it curvy.



# NEW

CHANGE a couple of months back we decided to alter the relationship of the modules in our Matrix. it only took a couple of hours.

carole's new eagle's-nest study.

below it is the reading cave.

this is the new storage module.

NOTE with this new configuration we have more liberated floor space at the open end of the room. you can make a loft with two modules or three (in line or in an L shape) then add to it later.

# MATERIALS LIST

## CUT PARTS/

|                                    |   |
|------------------------------------|---|
| 70 pcs. 2"x2"x48" (univ. members)  | Matrix, pallet rails & overhead support & ladder pallet beams |
| 32 pcs. 2"x2"x44 3/4"              | pallet limit blocks   |
| 32 pcs. 2"x2"x11 7/8"              |   |
| 4 pcs. 2"x2"x9 3/4"                | ladder (steps)  |
| 8 pcs. 1/2"x48"x48" DFPw.          | panels  |
| 16 pcs. 1/4"x11 7/8"x44 3/4" hdbd. | pallets   |

## HARDWARE/

|  |   |
|--|---|
| 120 pcs. 1/4"-20x3 1/2" flthd. blts.                               | basic cube joints, cube to cube, ladder panels to Matrix pallets-hdbd. to 2x2's |
| 28 pcs. 1/4"-20x2 1/2" flthd. blts.                                | panels to Matrix  |
| 64 pcs. 1/4"-20x3" flthd. blts.                                    | all bolts   |
| 12 pcs. 1/4"-20x4" flthd. blts.                                    | all bolts   |
| 224 pcs. 1/4"-20 hex nuts  | all bolts   |
| 224 pcs. 5/16" flt. wash.  | all bolts   |
| 224 pcs. 1/4" Split-Spring Lock Washers                            | all bolts   |
| 12 pcs. 1"-diameter furniture glides, with nail (Domes of Silence) | bottoms (verticals)   |



**JOSH HENRY**  
**LIVING**  
**STRUCTURE**

CHANGES/every morning for the last six hundred days or so carole & i have awakened to a new & different kind of world. we have been joined by another person, full-fledged, intelligent & active. all my life i've thought in some Calvinistic, Baptist way with a quasi-scientific twist that "yes, it is necessary to explore the possibilities of genetic combinations blah, blah, blah." supercool didn't prepare me for the wonder of the benign explosion which was the entry of joshua henry isaacs into our collective life. i tended to think of abstract reasons for rearing children making it worth the hassle. the awesome truth is that it's some experience. like having some exotic stranger come for a long visit. it's the one life experience i've found impossible to take for granted even after all this time. no ego trip like the old-fashioned world but more like watching a beautiful little peach tree grow. the only ego thing involved is watching reinterpreted echoes of your own behavior & attitudes appear in this midget like the reverb from some mighty speaker in the sky driven by the DNA spiral. sometimes this is OK but sometimes it makes you cringe & hope for the best.

CRISIS & THE SHOEMAKER'S CHILD/we were working pretty steady at the university & in Groveland when josh henry was little so we couldn't seem to get centered on designing & fabricating a Structure for him. i think part of my holdout was rooted in the fact that i had never been around little kids & was uncertain of the parameters. most of my knowledge of babies was derived from watching old movies on television. we were also moving around a lot so he ended up in a simple, clean, white, Shakeresque room in the Chicago apartment which carole fixed for him. his tools (toys) were nicely organized & he slept at first in a folding cloth thing with a metal frame. in the movies i'd watched they never grow much but in real life it's like God is blowing up a balloon, so he was soon too big for that thing. carole was already making drawings of a Living Structure for him but i still couldn't get focused on starting actual building. trouble in eden. one day i found myself in a suburban department store hallucinating carole asking the lady if she could buy a crib. this immediately induced hyperventilation in my system & i got ready to demonstrate new audio highs for the very proper audience of clerks & matrons. together we managed a fair Wagnerian racket.

RESOLUTION/carole is funny. at some human points she becomes a rock with the power of speech. she calmly said that the kid's head was going to be flat on top (or if we were lucky, slightly geodesic) unless he got a bigger place to sleep. she really understands motivation technology. there was no other choice though, so we got the nifty crib & it hung there for quite a while like the albatross, a reminder of a monstrous negative act. it sure got us on for his Structure though.

DESIGN/so carole designed it & i helped a little. she used Living Structure principles & based it on the Unit, or Cell, Matrix. this just means that each division is like a body cell, an indivisible functioning unit which combines in various ways with other cells to make a whole system.

PARTICULARS/this Structure is made of two 36" cubes with 2x2 skeletons. one is for activities & the other for relaxation & renewal. the activity one has a table & a sliding bench which he can adjust. both can be moved vertically as his size changes. the table can be used from outside the structure with a free cube as chair. he can also integrate a friend in this way.

sometimes we can share a meal with him at his table rather than assuming he always comes to ours. that's important.

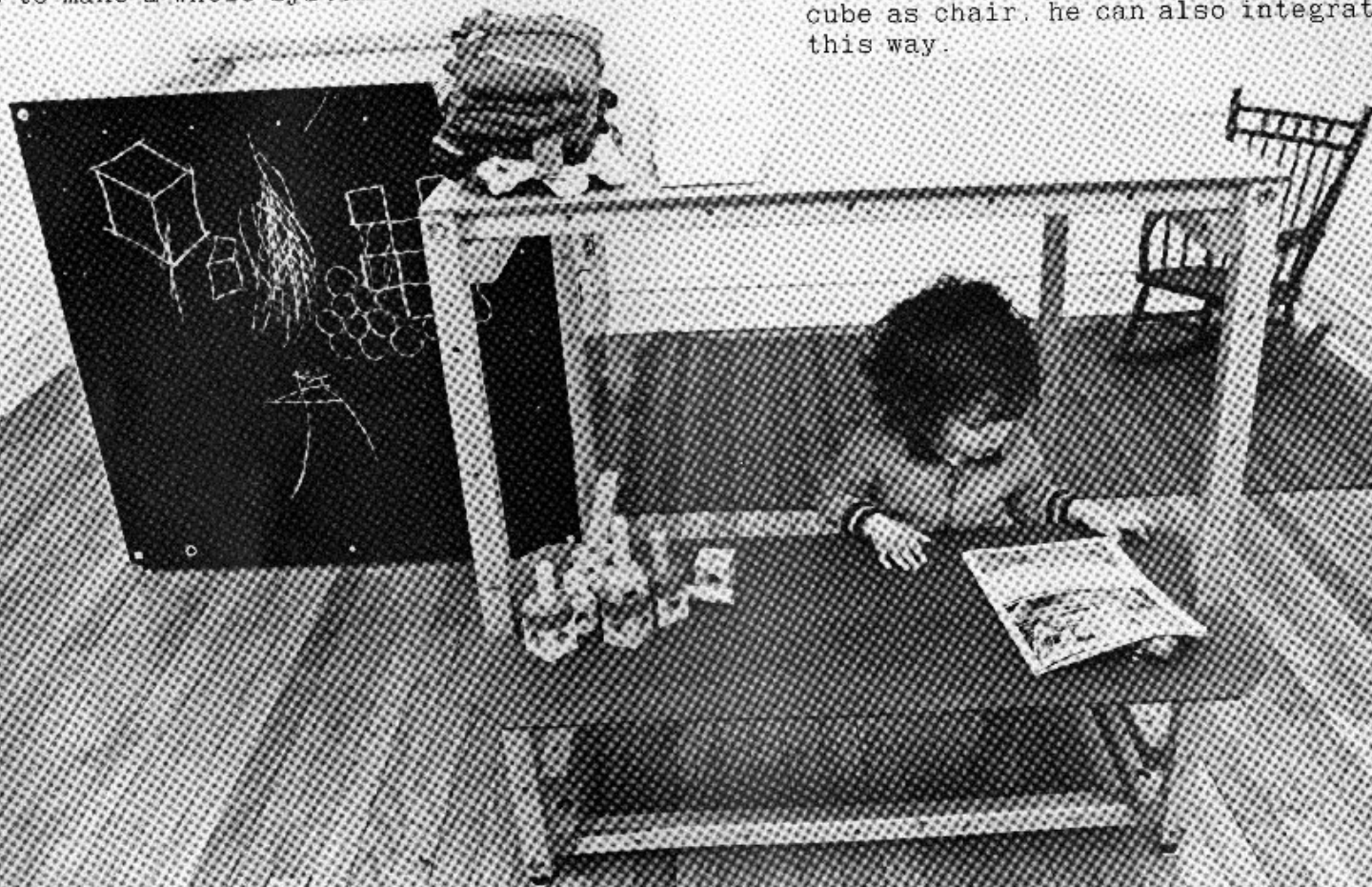

# REST

THE QUIET CUBE/the relaxation part is closed on two sides by painted hardboard panels & on the third side with a chalkboard panel. the fourth side is sealed natural plywood with a round hatch for entry & exit. top is open because too much separation is negative. a square foam mat covers the hardboard bottom & we use little contour sheets his grandfather made for him. the alternative to this might be cover sheets like an envelope with one side open. the isolation of the four topside bones makes them great grippers for exercising & teething.



MOBILITYthe bottom sleeping mat can be put in any of six positions so you can start with a newborn kid near the top & lower it as he grows. the working portion of the Structure is covered on top by a hardboard panel with a naugahyde scrap cemented to it. we use this to perform the routine maintenance operations on the little man. he gets his filters checked & oil changes here. he looks good sitting up there after a bath in a towel, like a crazy, friendly nomad. this table plane also gives him a roof for his work area & that completes his house.

the hardboard bench & table are simply waxed & rubbed down by hand.

WHERE TO PUT IT/although our original plans called for the two cubes to be bolted together in use, we found they worked better as free individual units. this allows josh or us to change the relationships & expand their uses. try to avoid jamming them against a wall or into a corner because that wrecks your freedom of movement around them & makes it difficult to clean the room.

STORAGE/the 16"-Panel Matrix (p. 57) here is a major life-support device & it completes the Living Structure. it is used as a sorting & storage Matrix. there's much talk on storage but not enough about "sorting," which seems so fundamental to survive. without the developed ability to sort & differentiate, organization is very difficult. the six lower cells are most accessible to josh & no specific consistency is expected because it is the principle of sorting which is so important. as he grows he will lay on his own levels of patterning. carole uses the top three cells for out-of-reach stuff. he doesn't seem frustrated.

sara





LIBERTY/we thought it was major to supply josh with equipment & information in a way & quantity responsive to his own clock in processing it. when you think about what you see around and in yourself, it seems that many life problems are resultants of kids being held back & never getting enough extension of their faculties. the old culture with its usual finesse observes this in eccentric ways when parents archly play Wagner twenty-four hours a day in the crib. this is patently crazy; a child is not a goose to be stuffed. this prodigy packing gets you a twenty-year-old with an enlarged liver who is afraid to go out with women.

AUTONOMY/what we're trying to get into with the Living Structures for kids is close, unobtrusive observation that attempts to have a worm in the vicinity when baby bird is awake. if you never get to exercise powers of judgment & discrimination as you grow, no one can expect magic matureness just because your hair is gray.

the entry hatch with cover is an example of the opportunity for autonomy.

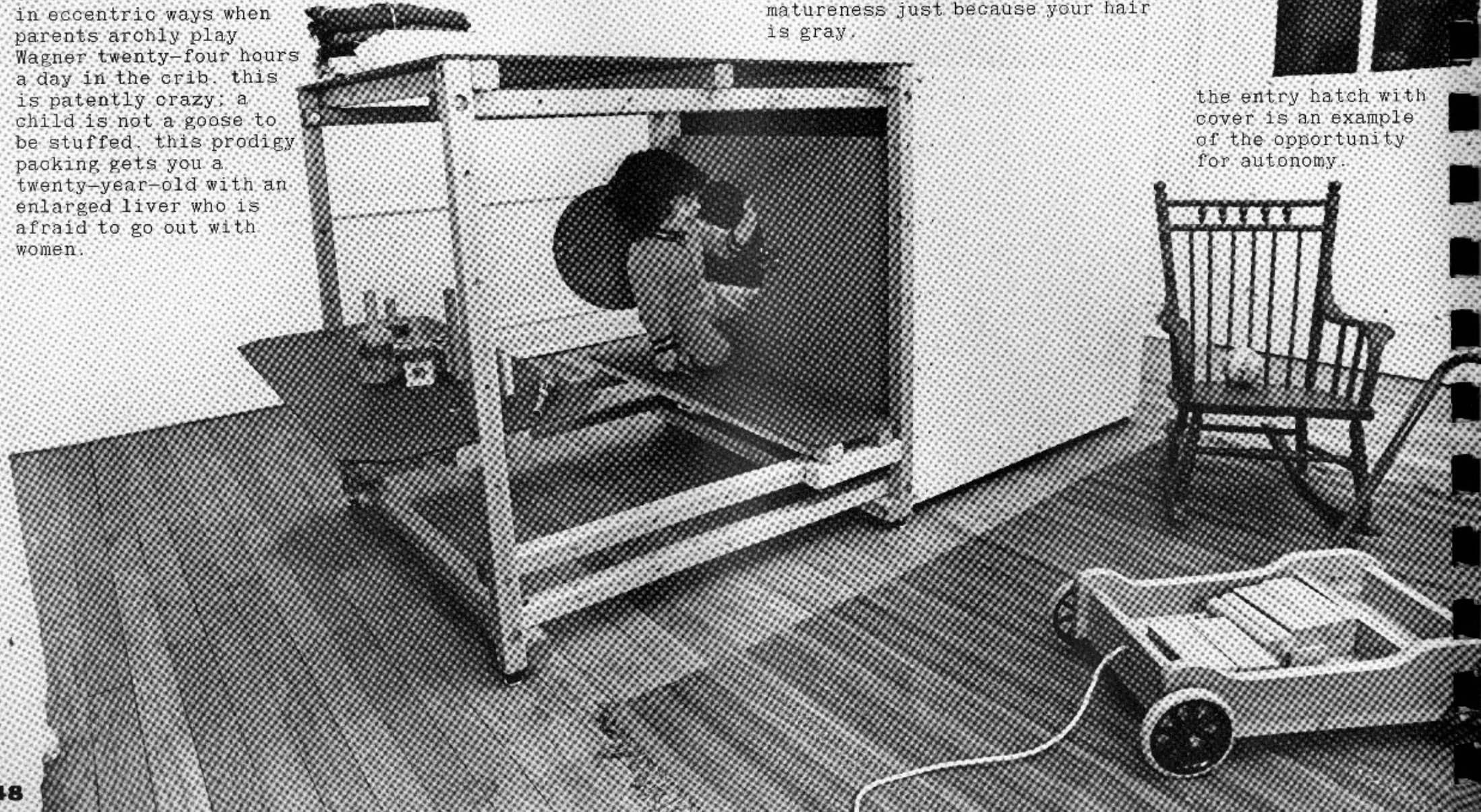

# OPEN

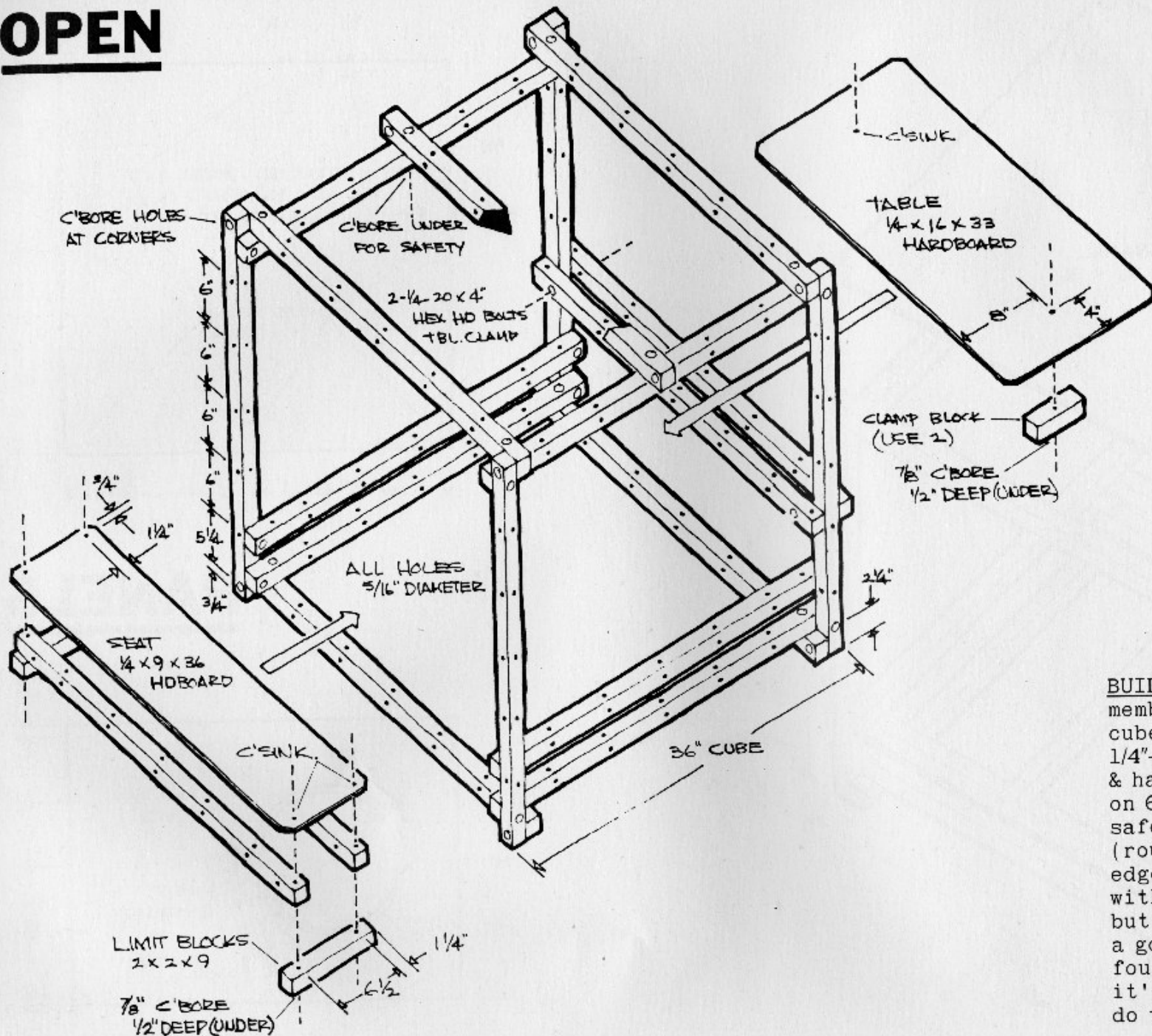

BUILDING THE ACTIVE CUBE/these members will remind you of the 24" cube. but they are assembled using 1/4"-20x2 1/2" hexagonal-head bolts & have a secondary hole pattern on 6" centers. it's a good tactile safety idea to put a 1/4" radius (rounded corners) on the long edges of the members. we do this with a high-rpm shaper (see p. 7), but you can do it with patience, a good eye & the fine side of the four-in-one rasp. don't hurry, it'll build your character. don't do this to the short edges.

# CLOSED

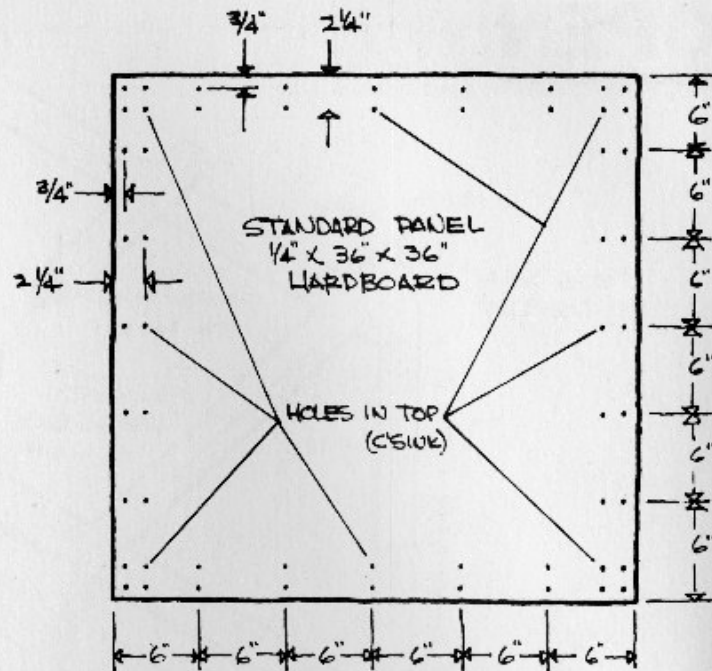
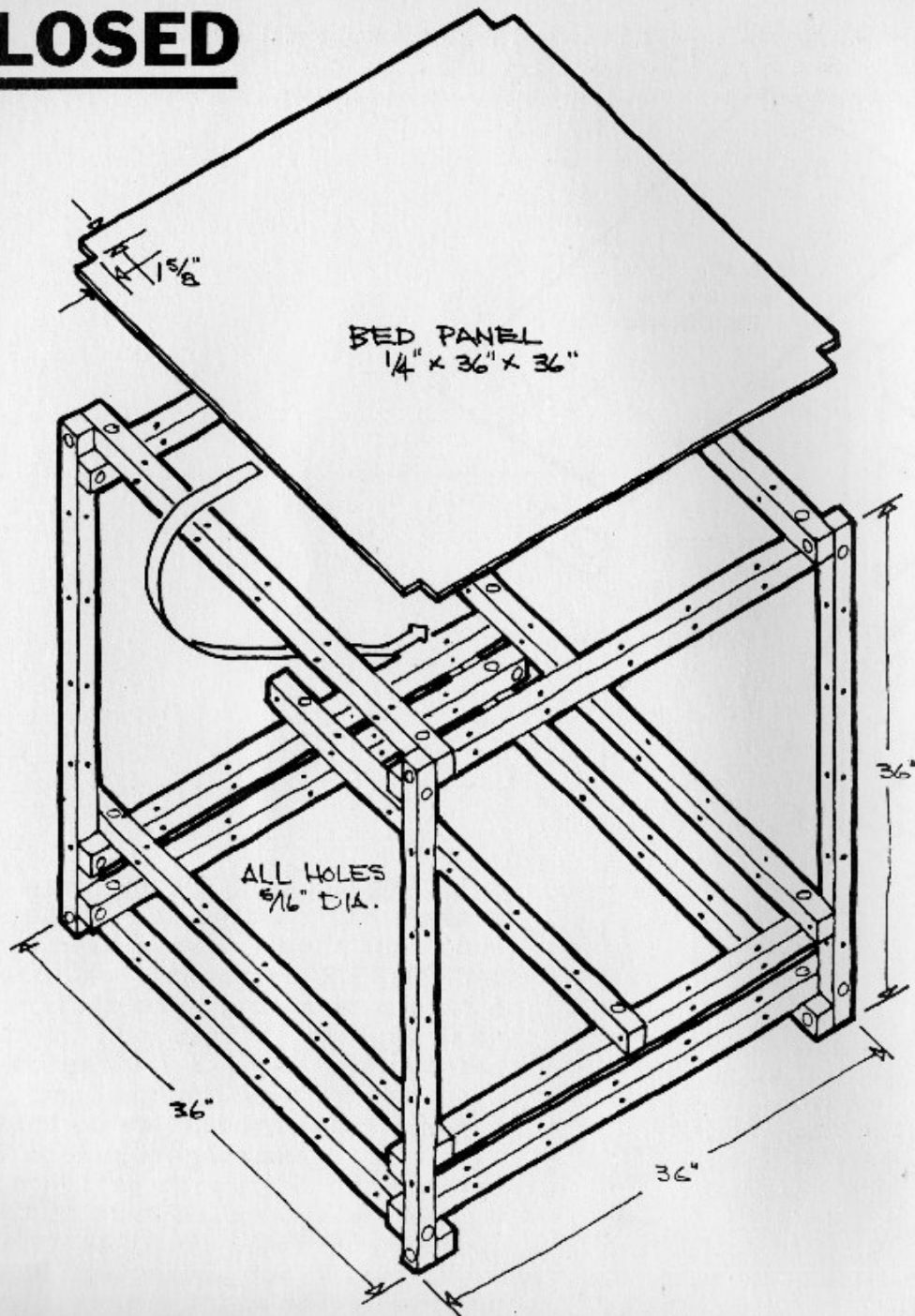

# PANELS

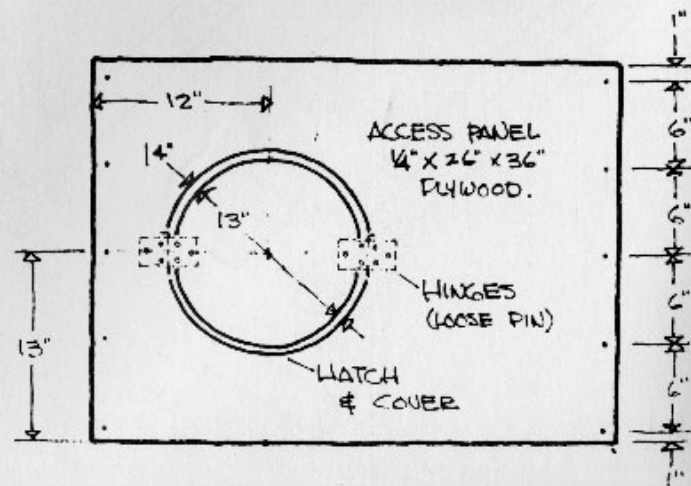

# SAW GUIDE

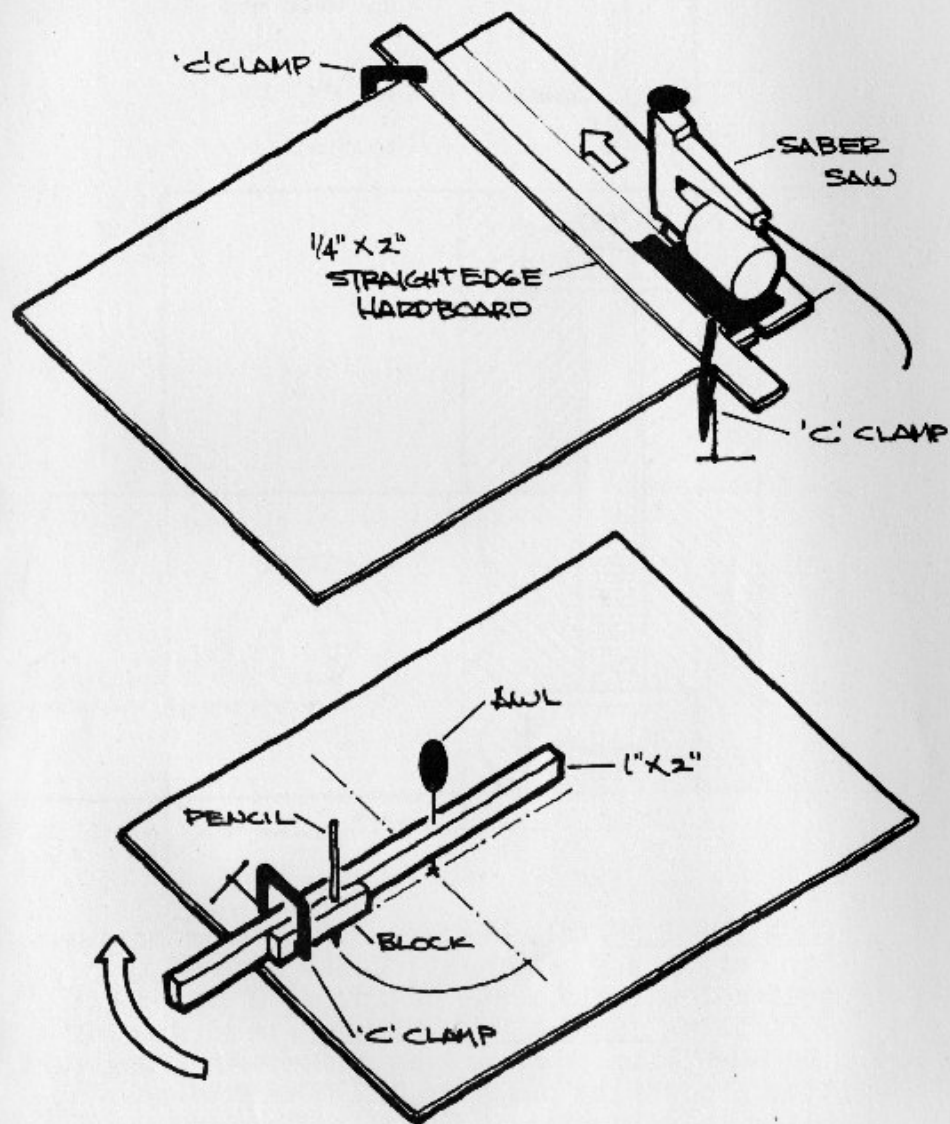

# STACKED WASHERS

TOP SKIN - 3" FLT. HD. BLTS.  
SECURE IT &  
CORNER JOINT

SIDE SKIN PANEL -  
3" HEX. HD. BLT  
(HEAD OUT)  
SECURE IT &  
CORNER JOINT

NOTE STACKED WASHERS  
(IN C'BORES) PREVENTS  
H'DB'D PULLING THRU  
WHEN NUTS ARE  
TIGHTENED.

SIDE SKIN PANEL  
TO VERTICAL ONLY -  
2" FLT. HD. BOLT  
(HEAD INSIDE)  
ACORN NUT

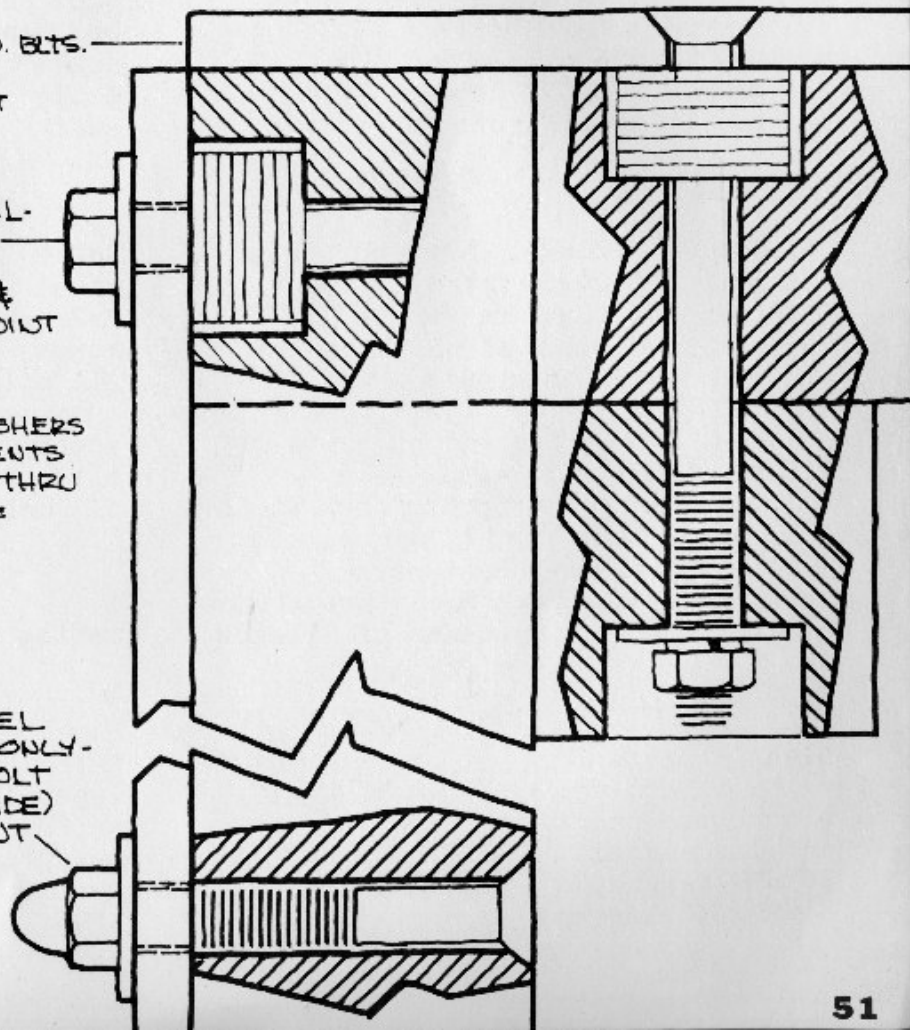

# BEAM COMPASS

# MATERIALS LIST

## CUT PARTS/

37 pcs. 2"x2"x36" (univ. members)

2 pcs. 2"x2"x9"  
2 pcs. 2"x2"x5"  
4 pcs. 1/4"x36"x36" hdbd.

1 pc. 3/8"x36"x36" DPFw.  
1 pc. 1/4"x26"x36" DFPw.  
1 pc. 1/4"x16"x33" hdbd.  
1 pc. 1/4"x9"x36" hdbd.

## HARDWARE/

41 pcs. 1/4"-20x2 1/2" hx. hd. blts.  
30 pcs. 1/4"-20x3" flthd. blts.  
2 pcs. 1/4"-20x4" hx. hd. blts.  
6 pcs. 1/4"-20x2" flthd. blts.  
73 pcs. 1/4"-20 hex nuts

6 pcs. 1/4"-20 cap (acorn) nuts  
120 pcs. 5/16" flt. wash.  
79 pcs. 1/4" Split-Spring Lock Washers  
2 pcs. 2" back flap hinges (loose pin) with fasteners  
8 pcs. 1"-diameter furniture glides, with nail (Domes of Silence)

## MISCELLANEOUS/

clear Firzite

blackboard paint  
acrylic enamel  
36"x36" naugahyde & adhesive  
3"x36"x36" foam mat

two Matrix cells, rails,  
table support, bed sup-  
port, seat & overhead  
panel support.

seat limit blocks  
table clamp blocks  
top panels (active area)  
side panels (rest area)  
bed panel  
access panel (rest)  
table  
seat

2x2 to 2x2  
panel to 2x2  
2x2 table clamp  
access panel to 2x2  
all bolts (except  
access panel)  
access to panel 2x2  
all bolts  
all bolts

bottom (verticals)

finish members & access  
panel  
panels  
panels  
panels

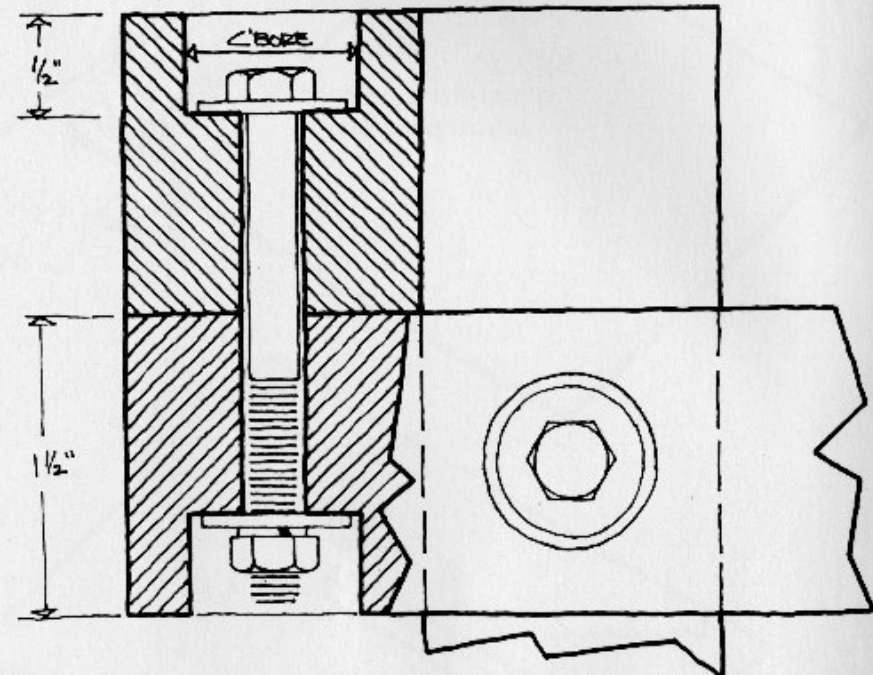
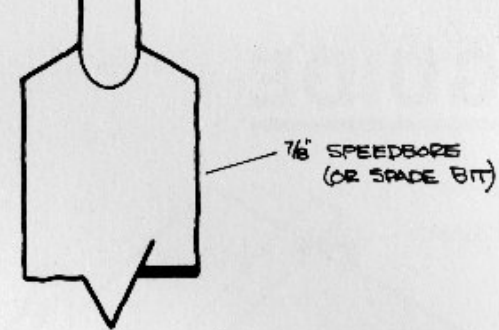

COUNTERBORING/this unit is intended primarily for children so we counterbored some of the bolt holes. this means taking a 7/8" speed bit & drilling no more than 1/2" deep before doing the 5/16" hole. this prevents the 2 1/2" long bolt from projecting past the 2x2 faces. we have applied this to some of the other Living Structures & you may want to follow suit. the main negative is that it specializes your members into rights & lefts so they are standard members rather than universal ones.



KIDS can sure use  
real tools  
if you don't push.

WORKROOM IN CHICAGO/labeled  
egg boxes for storage (on right)  
& 24" cubes used for drawing,  
typing, models & paper handling,  
completely surrounded by  
the Information Walls.

## INFINITE STORAGE SYSTEM



*Eggs*

TRUCKS  
**EGG**  
FRAGILE - HANDLE WITH CARE

*Eggs*

STORAGE MORALITY & LOGIC/it's a big one. i guess the condition that drives most storage fanatics is the fact that production & merchandising have become our religion in the last thirty years. most of us have a real warehousing problem because we are the pampered recipients of a flood of things allegedly developed to make us happier. we are now beginning to tumble to the queasy paradox that this proposition sounded great in theory but worked like a lead surfboard in practice. every new acquisition just loads us down with more obligations & expenses in time & productive effort. it's become evident that this is a crusher, leaving little time for inventive work & the individual search for peace of mind.

LIVING STRUCTURES & STORAGE/this conditioning sometimes leads people to wonder why my structures don't include superstorage. it seems marginal or improvised to them. after all, the guy's wife has twenty-three pairs of shoes & boots for several different outdoor role-taking shots. my thoughts on the quicksand of products & services hinge around using such offerings very selectively. that's the key word. the old-fashioned world wasn't perfect. there were wonderful aspects of simplicity which we can observe & apply in ways appropriate to our context but there were some strong negatives. if only we could have entered the twentieth century with a head-set of objectivity & selectivity toward the developments of high technology. instead we put all the basic-information research insights & spinoffs in the service of a manic, primitive, ego-tripping, anxiety-ridden scarcity psychosis that was showing massive fractures even before the social critiques of the mid-1800's. if our society had been more conscious & hip in ways to join & nurture evolution we might have avoided some of the pain & hurt of that whole era.

STUCK WITH STUFF/it's the nightmare of the sorcerer's apprentice with stuff flooding & distorting our lives & feelings. all the things that we are engagingly assured we "need" truly answer no fundamental cry from the soul or murmur of discomfort from the body but are an attack of collective mania like the dancing cults of the Middle Ages. the only resolution is to use less, consume less, have less in your field of action. this will heighten the significance & the enjoyment of what you have & give the same sort of peace that exercise outdoors gives the body.

F. Scott Fitzgerald's rich boys were bored & sated because they had everything. witty & humane Lincoln was excited by mildewed law books & fire-light vented through a clay chimney.

EGG CARTONS/even if you try to wear life like a loose garment you build a surplus. work, time & friends contribute. some of this is rare information & some has talismanic importance in a human way. some objects like tools we conserve against the time when we can recycle them. so we discovered the egg carton.

supermarkets, restaurants & hotels get eggs in these great cartons. they measure 12" wide

x 24" long x 11" deep. what dimensions! not since the Periclean press conference & the announcement of the discovery of the Golden Section have such proportions been laid on us mortals. they hold file folders, papers & magazines, slides, toys, folded off-season clothing, tools & volley balls. they can stack four high with stability & have neat holes cut in each end for handles when lifting.





NEW STORAGE MATRIX/despite the beauty of the egg carton, i am not an absolute animal. a lot of thought & work has been given to the development of storage systems which relate to Living Structures & are supportive of their systeming.

STRESSED PANELS/the first great switch in structural concept was the use of the universal member. the second was to the Panel Matrix, that means changing from linear members to the use of stressed-skin, thin plywood diaphragms. these are still distributed on a 3-D space grid. i laid the theory base for this in the beginning, the late 1940's. despite leaving a trail of people with bent ears in my wake all that time, i hadn't really built much using this principle purely. the gain was obvious. plywood is a strong material with equalized strength due to the overlapping layers. it is really durable.

ELIMINATION OF FRAMING/extra complications caused by having both covering panels & framing lumber in a structure are tyrannical. cost & fabrication difficulties are increased & units are harder to take down & move. changing to the stressed panels simplifies the process considerably & makes beautiful structures.



DODECAHEDRON BREAKOUT/that summer of the many changes i worked on a 65" dodecahedron chamber with photo images inside. it was made of light plywood without lumber framing & joined by modified angle clips with stove bolts. we started clipping panels together in 1962 when jim built an early 48" Microhouse with turrets in a little timber ravine at Groveland. but that was made of 3/4" plywood so it was far too heavy to produce the advantages of diaphragm structure.

the dodecahedron was good. the structure was light, quick & direct to make & forgiving in assembly. (panels were easy to bolt together.) no hassles if the plywood warped a little. it all just straightened out & fell together. it was another new world.

FURTHER PROOF/in the spring of 1971 we built three prototypes of the 8' Microhouse using the stressed-load carrying-skin method & no framing. during the first test assembly i got up on the sleeping surface. it was 3/8" plywood slightly less than 48" square, clipped to vertical panels around the edge. what a neat confirmation! it had full structural integrity with the resiliency of the rigging on a racing sailboat.

IDEAS ON "SORTING"/the other component in the general context that nurtured the development of the Infinite Storage System was from the past. i was in childhood riding down a dusty Illinois country road with Aunt Helen. she radiated good humor, generosity & Baptist theology in roughly equal amounts. she is something even now. we were on the way to a little town called Fancy Prairie to Gene Baugher's general store. even a sortie to the general store was exotic in those preconsumption days, about equal to jetting to Xanadu from the yurt country. but a big part of the charge was that the store was also the post office. the main event there was an unbelievable wall grid of compartments each with its own brass door, lock & small glass pane. the deep interest was in the order involved here & i think it relates to ideas years later about the concept of "sorting" physical objects.

MYSTERIES OF THE WESTERN MIND/these considerations led to the realization that we are stalled with fanatical linear constructs in our minds yet these compartmentalizations are so limiting. they kill inventiveness & play in thought. at the same time it seemed we haven't pursued at all the very real sorting benefits of highly disciplined Aristotelian categorization in the storage of our artifacts. what a paradox. we use restrictive methods in thought & give our objects freedom. i decided to work on a new Storage Matrix.

PROTOTYPING THE INFINITE STORAGE SYSTEM/so chuck & lou came to Groveland that first summer & we put together the first production on a 16"-Panel Matrix. we didn't have too much money so we got some 1/4" plywood out of joe's old bread truck storage. it was exterior so it was generally sound except for the work of the field mice & the big black ants. on any country place you discover new colleagues in the race for survival. the mice have large brown eyes & the destructive abilities of Genghis Khan on amphetamines. the black ants are big & tough & would eat a Cadillac Eldorado if they thought it was wood.

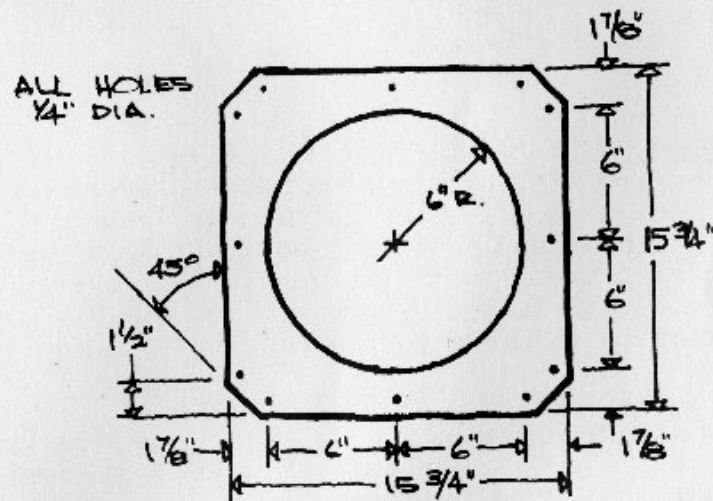

THE 16" GRID/anyway, we felt lucky to have some sheets of this so we worked out an ideal 100 per cent consistent grid pattern partially based on the reality that the actual panel size of 15 3/4"x15 3/4" would cut good out of 4'x8' plywood. i call the grid "consistent" because it can be filled in any or all of the three main directions in space without problems or compromise (or special unresolved conditions) just by adding the one-size, one-drilling-pattern universal panel.

# CONNECTORS & ASSEMBLY

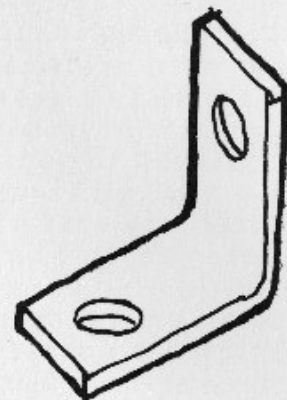

ORDERING MATERIALS/it's difficult to give directions for buying with this system because everyone wants something different in size or shape. but since a three-cube tower can be built from one 4'x8' sheet of plywood (with two panels left over), i suggest you get started by doing that. the order list below will set you up for it.

## MATERIALS & HARDWARE/

|  |                            |
|--|----------------------------|
| 1 pc. 1/4"x48"x96" DFPw.                           | panels (plus 2 spares)     |
| 120 pcs. 1/2"x1"x1" Stanley corner angles          | connections                |
| 120 pcs. 10-24x3/4" rndhd. blts.                   | connections                |
| 120 pcs. 10-24 hex nuts                            | connections                |
| 72 pcs. 10-24 flt. wash.                           | under bolt heads (outside) |
| 120 pcs. 10-24 "Star" lock washers                 | all bolts                  |
| 4 pcs. 1"-diameter threaded-shank furniture glides | bottom panel               |

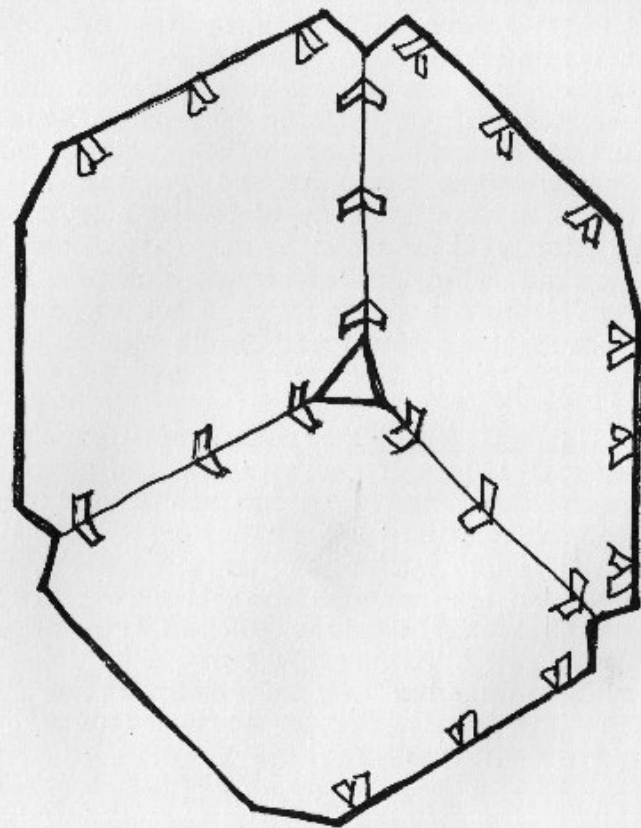

# MATERIALS

STACKS/we use these stressed panels a lot in verticals. you get maximum storage per floor area occupied. one 16" square on the floor produces over 14,000 cubic inches for storage. we did it for a film group in New York City. people & space flowed right through.

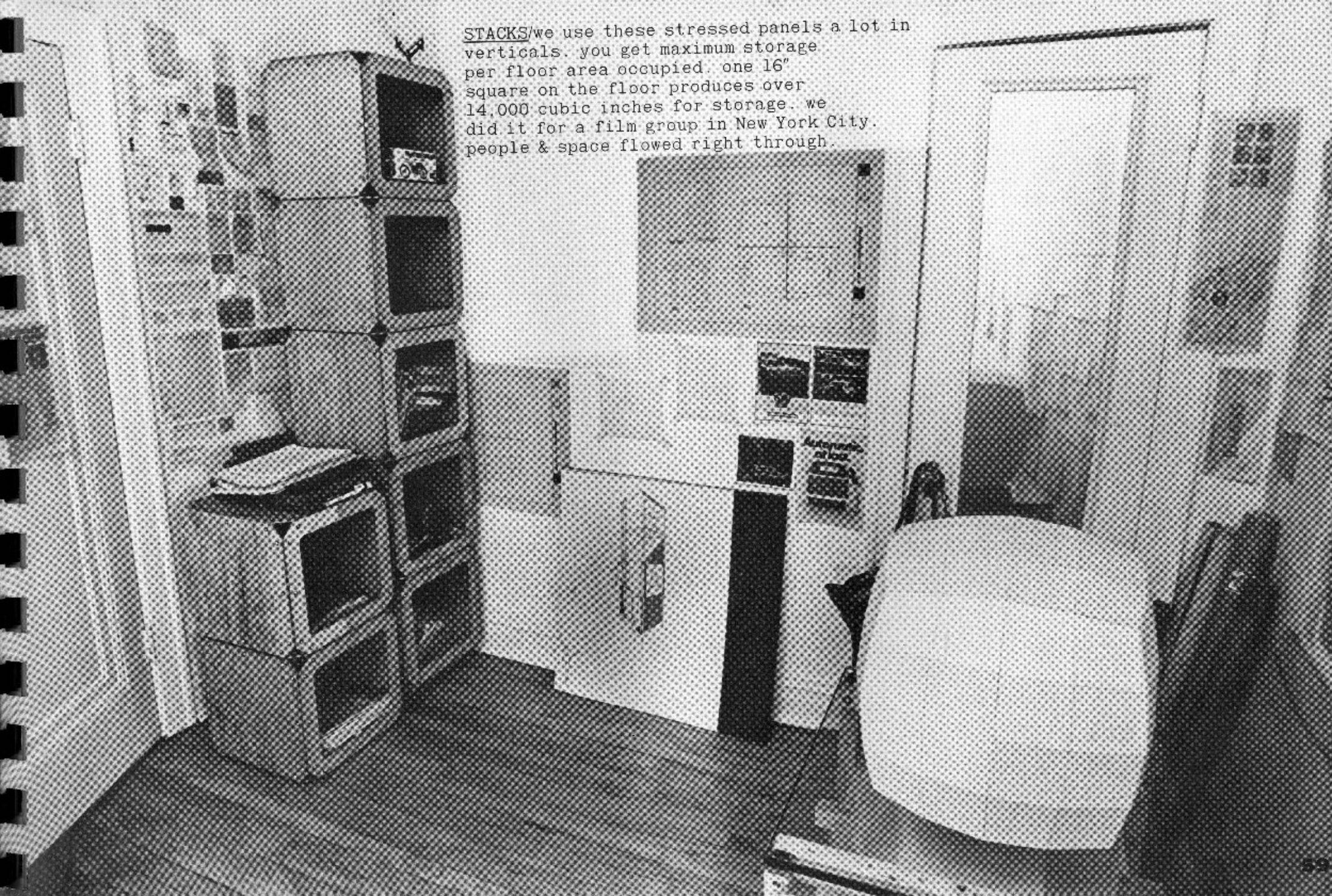

# MOBILITY

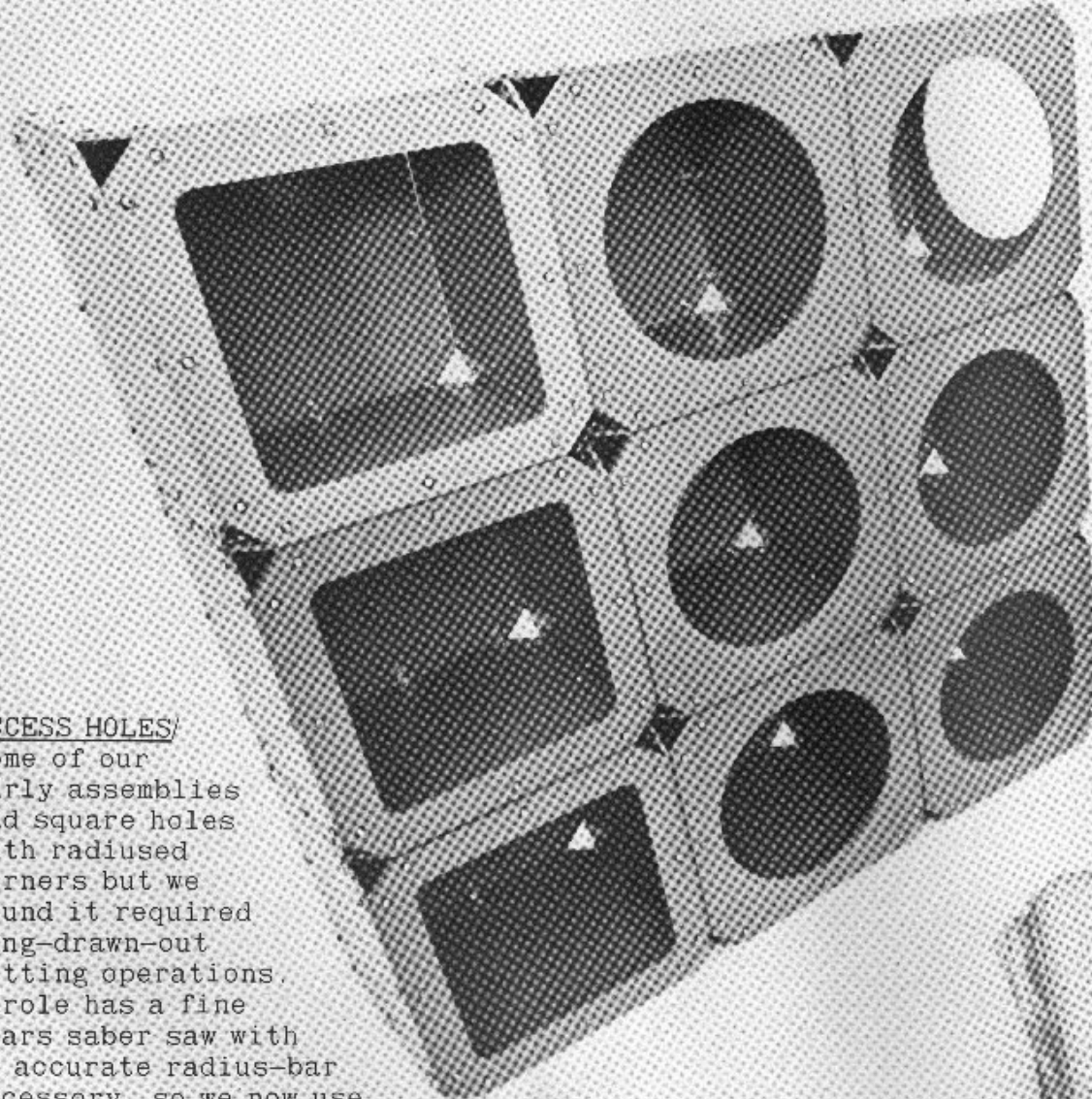

ACCESS HOLES/ some of our early assemblies had square holes with radiused corners but we found it required long-drawn-out cutting operations. carole has a fine Sears saber saw with an accurate radius-bar accessory, so we now use the circle for access. it's a cinch to cut & low anxiety in fabrication is truly beautiful. it seems more fulfilling to make a simple object with great fidelity instead of a gradiose one (every aspect of which is below one's expectations).



vicky



MOBILITY/this 9-cell unit is approximately 4' high & 4' wide. it could be a free-standing unit or the beginning of an entire wall. when knocked down for moving, the panels are a pile less than 11" high or about a tenth of the erected volume! this compaction means we are no longer shipping air all over the country.

CHUCK'S CHAIR/the Panel Matrix & the clips worked so well in the Infinite Storage System that we expanded the structural idea to a 24" space grid & made a chair. i call it chuck's chair because he seemed to have some special relationship to it from the first moment the raw prototype was assembled at Groveland in the old shop. he just liked it the way you like a puppy or a young colt. that's a good kind of feeling.

FREE CHAIRS/despite my efforts to integrate as many "furniture" functions as possible to realize the Living Structure idea, there is a purpose for a movable chair or two. you might want to move one nearer a window to watch a squirrel or a storm. two chairs form an alternative node for conversation & let you break out of the structured situation of the Living Structure. we built this chair as that kind of alternative.

we even put some of these on casters for some guys in New York City so you can just roll around using feet for propulsion.

# CHUCK'S CHAIR



THE ARTICULATED LIGHT BULB/most of the supports for electric bulbs are heavy romanticism & tradition. Living Structures require a durable inexpensive mounting for lighting which puts the light right where needed with great simplicity. this support adapts to many different situations & the simple articulation allows movement & change of position at will. this construction is described on pp. 64-65. by putting a hole in the exact center of each panel in the Infinite Storage System the ALB can be mounted almost anywhere on it. it can also be fixed to the side or back panel of the chair.

FUNCTION & OPTIONS/the plywood is 3/8" & pretty resilient to sit on but you will probably want to throw a pillow or a rug in it to make it softer. i like sheepskins but find it hard from the sheep's point of view. it works with slab foam cushions too. you can use Dome-of-Silence furniture glides in the bottom panel but i think the little metal tetrahedrons make more sense. they broaden the base & provide greater stability. if you really need to save space or have problems getting the welding done just use the glides. the slot front & back is for ease of assembly (later used to store books).

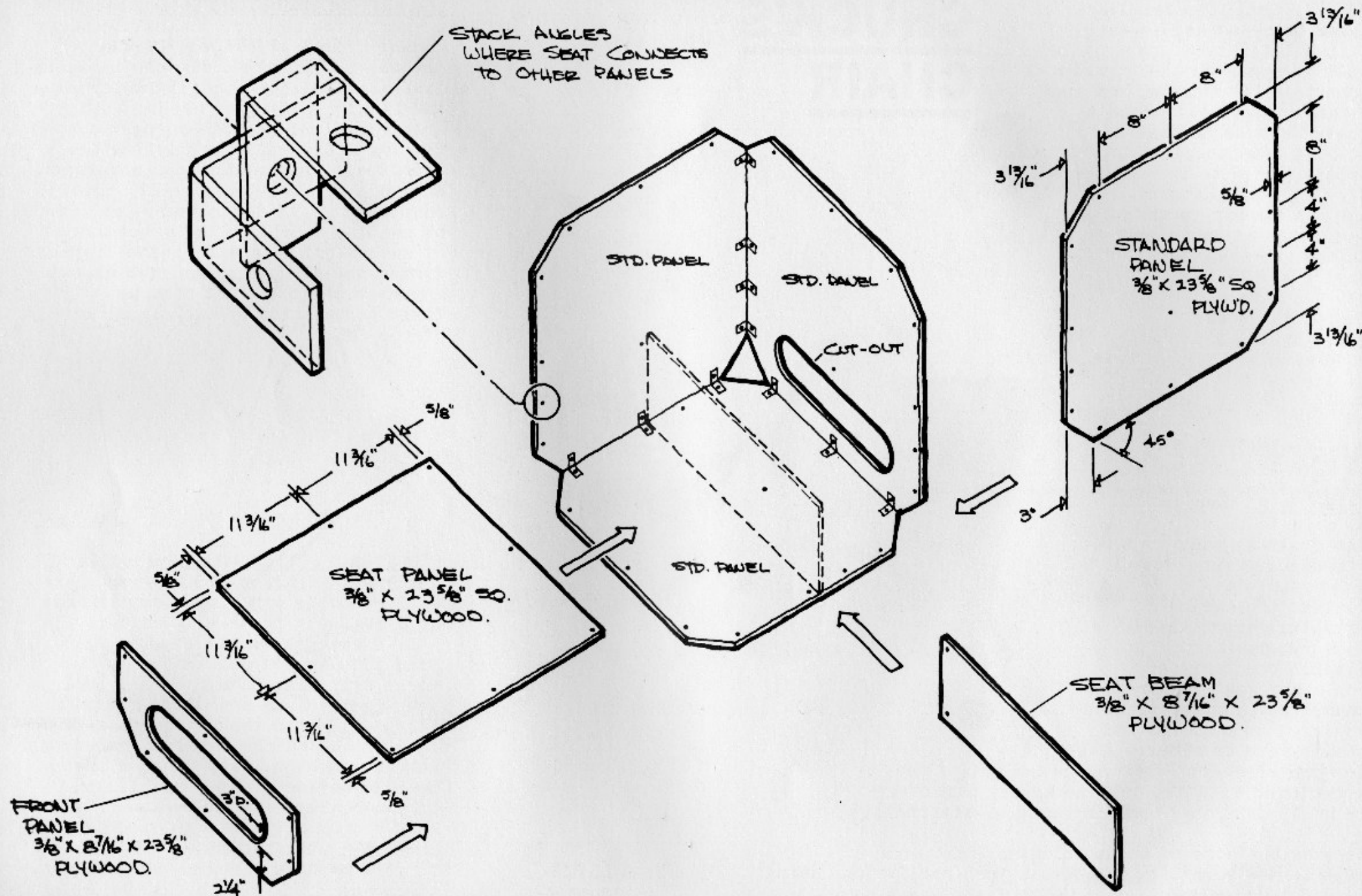

# MATERIALS LIST

## CUT PARTS/

- 5 pcs. 3/8"x23 5/8"x23 5/8" DFPw.
- 2 pcs. 3/8"x8 3/8"x23 5/8" DFPw.
- 4 pcs. 3/4"x3"-diameter DFPw.

panels  
front & seat beam  
feet

## HARDWARE/

- 29 pcs. 1/2"x1"x1" Stanley corner angles
- 29 pcs. 10-24x3/4" rhd. blts.
- 29 pcs. 10-24 hex nuts
- 29 pcs. 10-24 "Star" lk. wash.
- 4 pcs. 1/4"-20x1" flthd. blts.
- 24 pcs. 5/16"x8" cold rolled steel rod
- 1 pc. 3/16"x1"x4" sheet steel
- 16 pcs. 5/16" nylon wire retainers

connectors  
connectors  
all bolts  
all bolts  
feet to legs  
legs  
feet to legs  
legs to panels

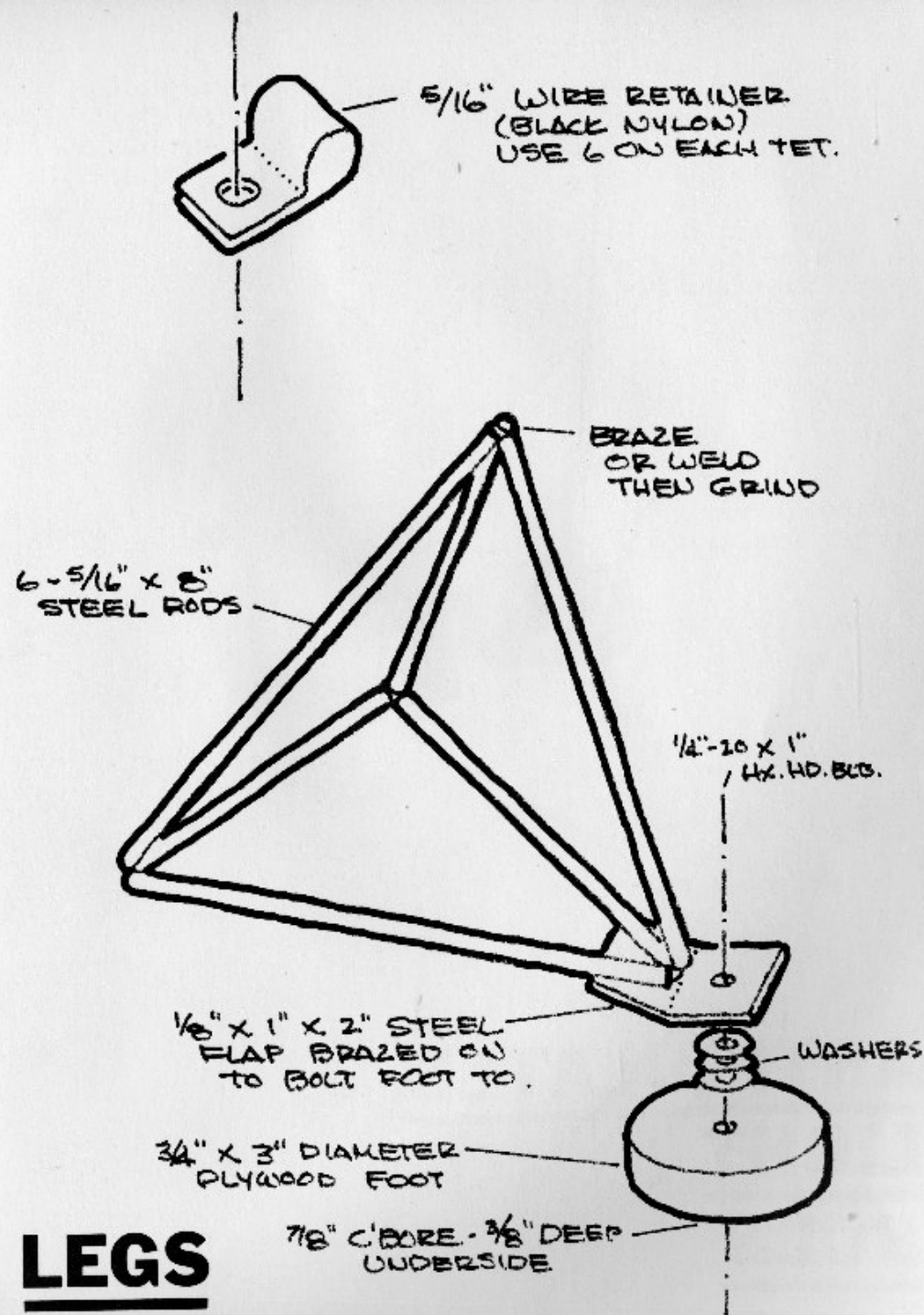

# LEGS



3/8"-diameter  
round aluminum  
rod (soft)

3/8" ball stud  
with thumbscrew

socket clasp

16/3 SJ cord

socket

reflector flood lamp

# ARTICULATED LIGHT BULB

MAKING THE ARTICULATED LIGHT BULB/most hardware stores stock the rod in a Reynolds Aluminum display stand, it is soft & easy to bend without cracking if you take it slow & gentle. put the rod in a vise & slip a short scrap of 3/4" pipe over the end that sticks out. this gives leverage & control, you can produce a neat, sharp bend. various lengths of rod (& ratios of bent-to-straight) may be used but we make most of ours 36" long with 9" at one end bent 30 degrees. this size can be used in almost any application & relates to the 72" length of the rod when you buy it. thus one length makes two ALB's.

BALL STUD & CLASP/a major part of the movement is supplied by this ball joint. these parts can be found in most photo supply stores. they are sometimes used in studio lighting. although there are several manufacturers, try to get the ones marked "Smith-Victor," the machining & plating are better.

THE BULB/we use bulbs with integral reflectors inside the glass, this eliminates the need for a shade. these are called "reflector flood lamps." hardware stores have them. the most useful size is 75 watts with smaller sizes in 30 & 50 watts. larger wattages are not operational because the additional heat will dry out insulation & cause electrical malfunction. it's a safety problem. bear firmly in mind that all bolts & particularly the ball-stud thumbscrew & bolt holding the pivot block in place must be tight at all times to prevent dangerous breakage should the assembly pivot & hit the floor. do not omit the rubber friction piece.

FINISHING/polish the aluminum rod with fine emery cloth & steel wool (linear motion only).

SOCKET/this is kind of a special socket so if your hardware man doesn't have it try an electrical supply house. do not substitute another socket because this one is covered in heavy rubber & has proved safe in practice for use with the very intense reflector flood bulbs. ask for it as a "rubber push socket, No. 161, made by Rodale." the plug used is a black rubber industrial plug called "rubber cord, grip cap, black, 15 amp, 125 volts," made by Hubbell.

ELECTRIC CORD/the number specifications for the cord just mean get 16-gauge, 3-wire cord, because triple wire is becoming standard now. if you are unfamiliar with wiring get a little on-the-spot advice from the electric supply people but don't fool around. do it carefully. we use 10' of wire on every ALB.

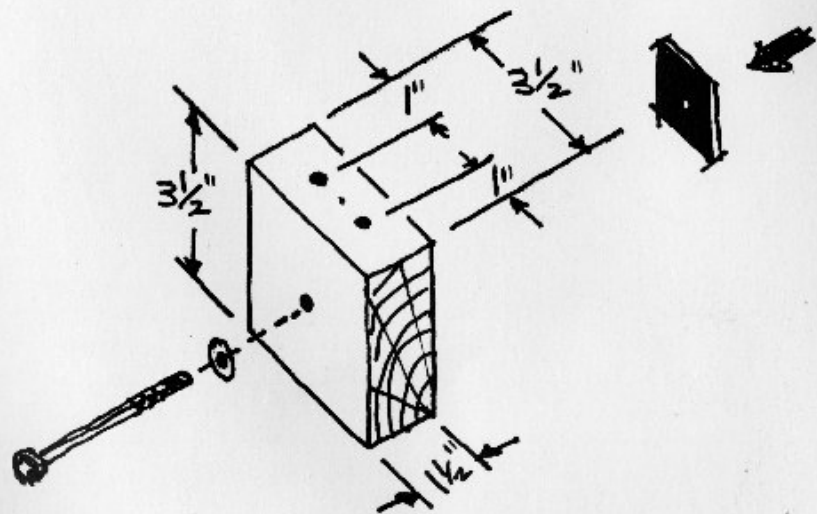
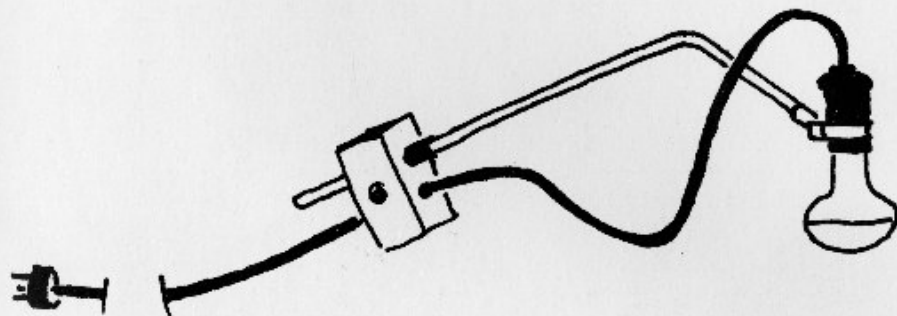

APPLICATIONS/the ALB can be used with any Living Structure or piece of equipment in this book. existing holes may be used or a modular hole can be added as in the Infinite Storage System. for children's use it may be good to double the pivot blocks & immobilize the pivot so the kids avoid accidents.

PIVOT BLOCK/this is just a 3 1/2" square sawed from a 2x4 with holes drilled for the aluminum rod, cord & the 1/4" hex-head mounting bolt. drill 3/8" holes for rod & cord. note that the rod is a force fit with a 1 1/2" length of clear vinyl tubing slipped on the rod to secure it (as the wood wears & the hole enlarges). finish with clear Firzite, sanding between coats to make a beautiful piece of wood.

FRICTION PIECE/cut a 1 1/2" square from an old car inner tube & drill a 1/4" hole in it. make sure it's clean & always use it for safety reasons. also use a lock washer under the nut on the mounting bolt to prevent its loosening up.

MICRODORM 2 is a Living Structure of great simplicity made from 3/8" stressed-skin plywood panels. there is no framing & only one universal panel pattern. 35 5/8" square. it's mostly for kids from four or five on but that depends on the kid. any kid-adult can use it, whatever the age.

## MICRODORM 2

SIZE & JOINING if you blow up the 16" Matrix of the Infinite Storage System to 36" you have the Microdorm 2. it is assembled with the same metal angle clips. the corners are cut to form triangles in the same way & the panels can be assembled in different combinations to fit various situations.

AREAS i'm in the study area under the sleeping surface topside. this is the table. storage cube is behind study with holes to inside & outside.

HOW MICRODORM 2 GOT BUILT/one day in 1963 i went to the Groveland post office box & found a letter from a guy at the University of Chicago. he was a psychiatrist for children & was doing some work with handicapped children for a government agency. he had heard of Living Structures & thought they might have meaning for kids in the state-care situations. his response was strong to my idea that new evolutionary equipment could support & aid the individual in highly positive ways. it was apparent to him that old-fashioned furniture just didn't do it.

SUPERFICIAL NEATNESS & HEAD BEDLAM/the doctor told me some eighteenth-century demi-horror stories about the way the hospitals were functioning equipped with traditional furniture. expensive hospital-type beds (negative & alienating to the kids) which had to be "made" in the morning so when the afternoon rest period came there was no place to lie down (that didn't mess up the bed), so they ended by lying on the floor under the beds. the large ward-like rooms apparently had the usual hospital kind of small metal cabinet at the head of the beds. these didn't offer any storage for projects that kids like to do. also there was no individual or adequate work space for building models or study. all in all it sounded like a great factory for ensuring a plentiful supply of institutionalized wards of the state.

WASTE/the situation with these children was so poignant because they just had a slight edge taken off their abilities & it seemed possible that with the right kind of nurture they could develop, become independent & live pretty much like anyone else. it wasn't difficult to respond to this situation because it was a classic example of waste of resources, human & physical. it just didn't make sense.

DEVELOPMENT OF THE DESIGN/when i first started working, after discovering the Matrix Idea, i used a very general, comprehensive, statistical program to explore many configurations & use-patterns of the Living Structures. the ground was pretty well covered. Microdorm 2 was a part of a process growing from some early work. the Living Structure for the kids was a stage of that process. we worked out a unit with work space, seating-lounging & study, clothing, storage & the usual high bed (which eased another problem of conflict growing out of other kids sitting on your bed & wrecking it). all these were supplied on an individual basis to cool the friction of interpenetrating actions. if we use territory intelligently, sharing can come forth as a natural result of peace of mind. old-fashioned design forced sharing & that won't make it now. one of the best possibilities of the unit was a panel system, integral, to give some privacy to the individual. we even developed a procedure to supply fabricated 2x2's & let the kids finish & assemble them. with this kind of real accomplishment the project began to sound like real life.

## PROBLEM

MOMENTARY DEFEAT/we let lack of funds defeat us. the state refused funds for such an "experimental" project & the foundations were unmoved by the doctor's lyrical logic about the Matrix & territory. i always felt very negative about it but we couldn't buy materials for the fifty prototypes they wanted to try it out.

but the configuration & the idea survived in this new design for Microdorm 2 & maybe we can do some good things with it now.

SLEEPING & HANGING OUT/on a foam mat on the topside panels. rails are easy to bend of 1/2" thin-wall electrical conduit using a hand bender. they're safe for bouncing kids & are nice to prop a pillow against. you climb up on the left end.

rachel

aaron

STORAGE CELL/this module is divided into eight small cells by interior panels. this provides sorting chambers for clothing, books & projects.

STUDY AREA/the panel forming the bottom of the study has a 12" round hole for feet to go through. so you can sit at the table. it is adjustable for growth with clamping members. two people can use the table (one inside & one outside seated on a free cube).

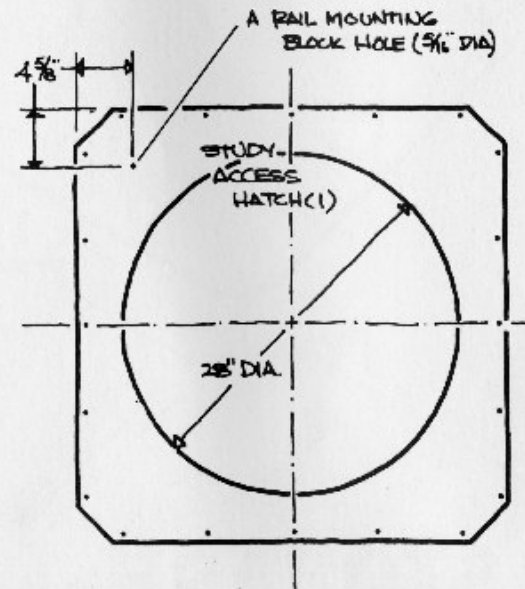
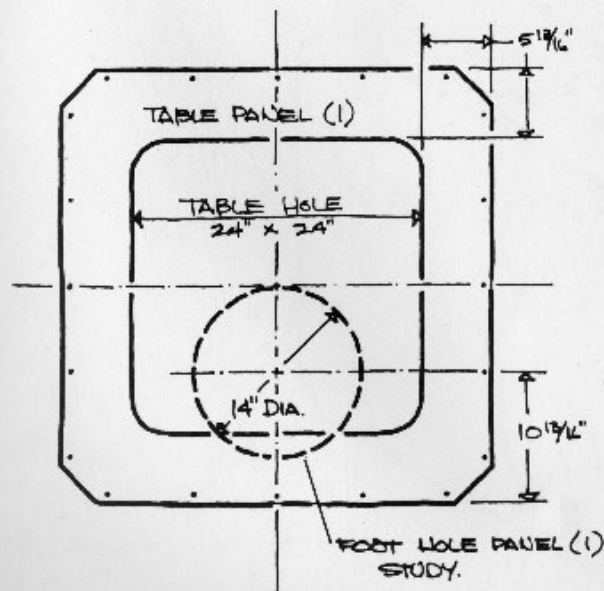
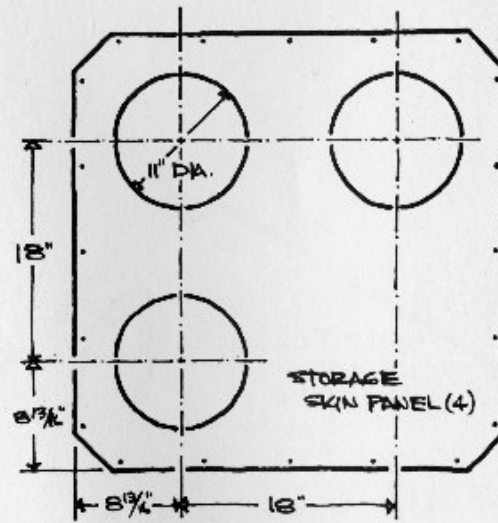
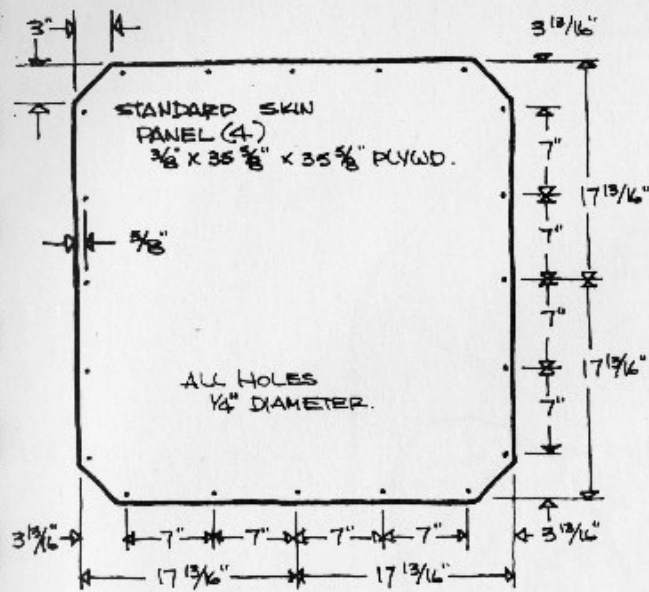

CUTTING THE PANELS/use 3/8" Douglas fir plywood (A-C faces). the eleven panels are all 35 5/8" square & can be gang-cut two or three at a time with a portable electric saw & care. lay out master panel & stack securely. clamp with at least two C-clamps. guide saw against hardboard straightedge that is also clamped securely to pile. don't hurry.

DOING THE LARGE HOLES/mark them all before nipping off 45-degree corners because you locate them in terms of the diagonal of the whole panel. most good saber saws now come with a radius bar for cutting round holes. this is a very precise way of doing it. sharp point at end of bar presses into wood & you just push saw around the circle. use the straightedge on the table hole.

HOLES FOR ANGLE CLIPS/lay out supercareful master panel & gang-drill three blanks at a time with electric drill in stand. clamp pile securely. these holes are critical for good assembly & strength of the final structure.

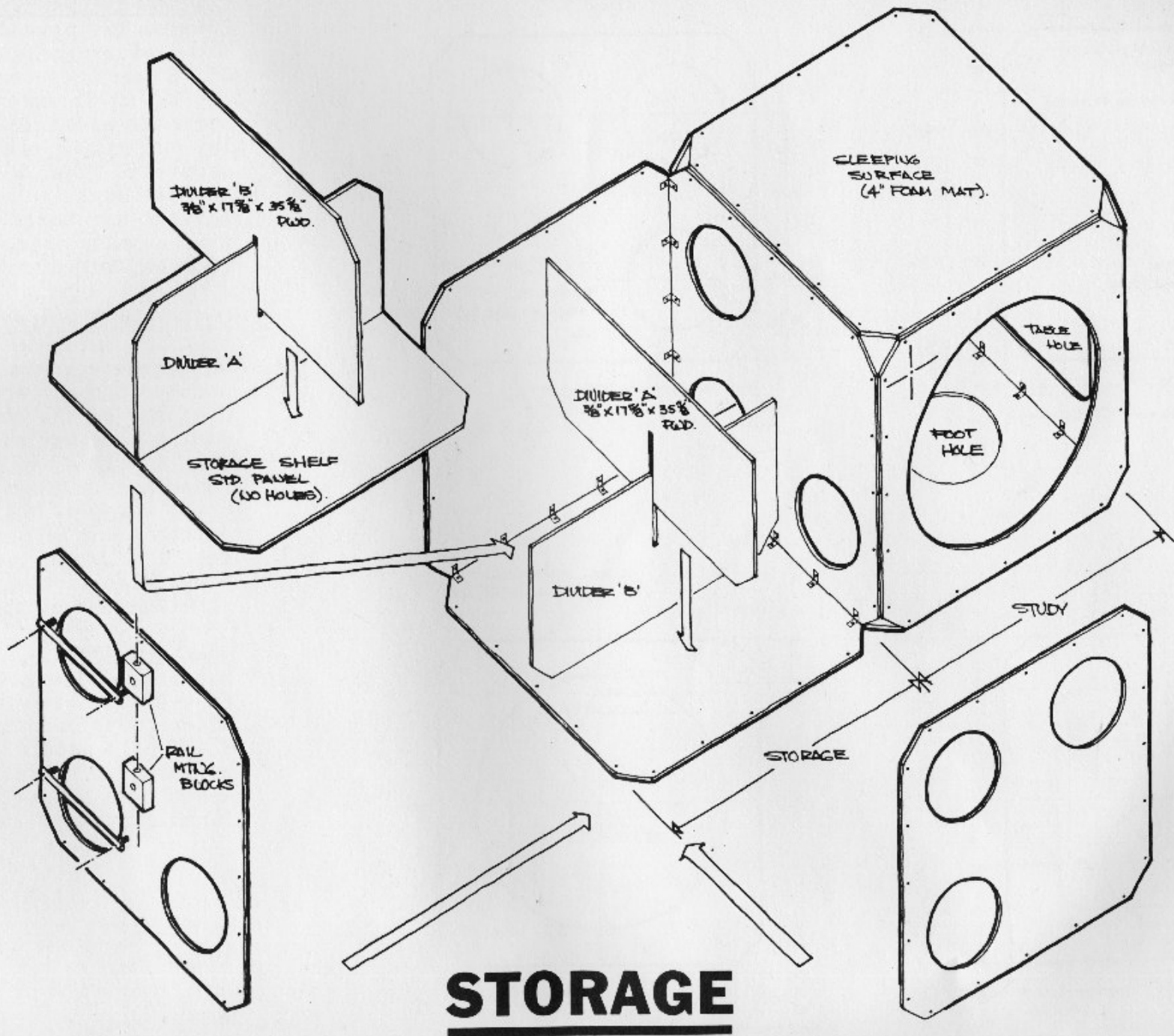

**STORAGE**

# MATERIALS

- 14 pcs. 3/8"x35 5/8"x35 5/8" DFPw.
- 120 pcs. 1/2"x1"x1" Stanley Corner Angles
- 240 pcs. 10-24x3/4" rnd. hd. blts.
- 240 pcs. flt. wash.
- 240 pcs. hex nuts
- 240 pcs. "Star" lock washers
- 2 pcs. 2"x2"x30"
- 2 pcs. 2"x2"x4"
- 2 pcs. 1/4"-20x3" hex. hd. blts.
- 24 pcs. 5/16"x8" cold rolled stl. rod
- 1 pc. 3/16"x1"x4" sheet stl.
- 4 pcs. 1/4"-20x1" flt. hd. blts.
- 4 pcs. 3/4"x3" dia. DFPw. discs
- 16 pcs. 5/16" nylon wire retainers
- 1 pc. 1/2" dia. x 5' EMT conduit
- 1 pc. 1/2" dia. x 10' EMT conduit
- 5 pcs. 1 1/2"x3 1/2"x3 1/2" wood blocks
- 5 pcs. 1/4"-20x1 1/2" flthd. blts.

- panels
- connections
- connections
- connections
- connections
- clamp beams
- blocks
- clamp beams
- legs
- feet to legs
- feet to legs
- feet
- legs to panels
- safety rail
- safety rail
- safety rail
- safety rail
- blocks to panels

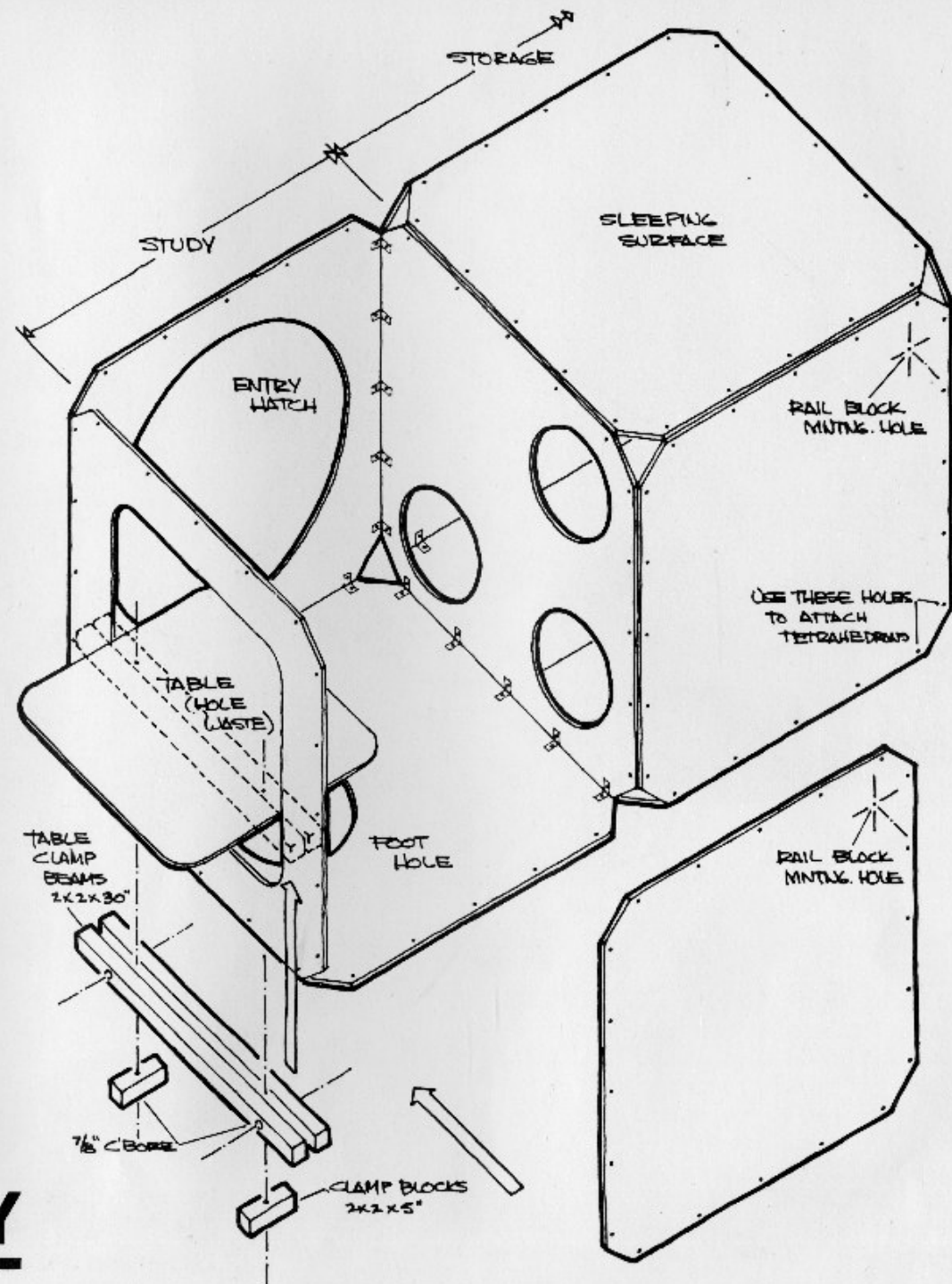

# STUDY



RAIL BLOCKS/make them 3 1/2" square (2x4 stock) with a hole to fit conduit & a 1/4" hole for mounting bolt. bend conduit so horizontal portion is 10" above top panel. clamp in position & use block as guide to drill through rail for mounting bolt. note the holes already in panels (see p. 71).

NOTE/

you may want to add a 2nd rail block in center of end panel & lengthen vertical run of long rail. this will make it more secure. if kid is little add a middle step of conduit midway between the two steps shown.



FINISHING/i think this Structure is really beautiful with most of the panels done natural (multiple coats of Firzite with fine sanding between), but the two blank panels would be great in blackboard paint. the one by the study might be blackboard inside & out. don't forget information.

VARIATIONS/bigger people fit on & in Microdorm 2. vicky is tall but she curled right in the study. keep in mind that you can vary the relationship & position of the panels. the table could be on a long side with the study hatch on an end, for instance. or four cells could be Matrixed together to form a large square sleeping surface on top with two studies & two storage modules below. community & privacy for two persons.

NOTE/tetrahedrons are same as those used on chuck's chair (pp. 61-63)-welded or brazed 5/16" rod with a 1/8" metal plate to bolt puck onto.

## **BIGGER KIDS**

# FUN HOUSE

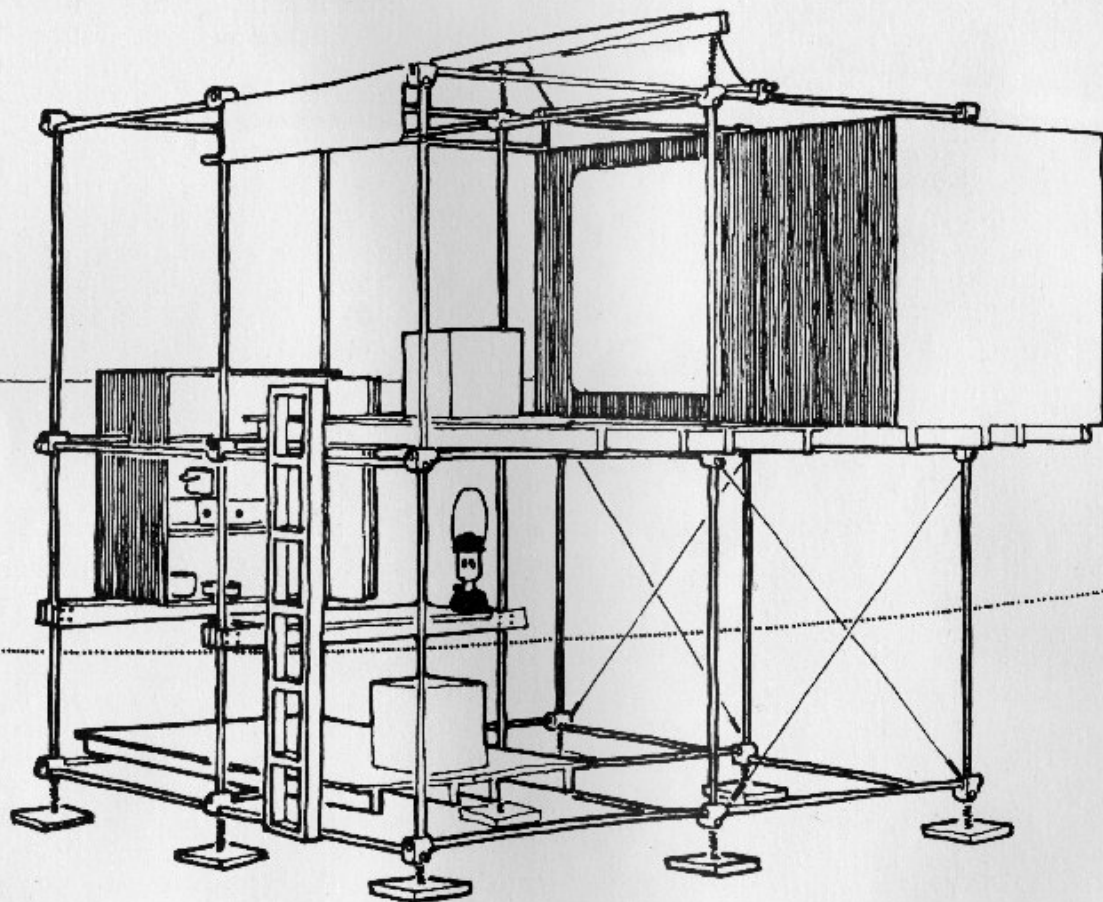

GENESIS/i designed the grandfather of this structure a long time ago when i began to discover that there might be some hope for an effort to put together a bunch of whole-system shelters that would offer some real human & ecological advantage. there were several components & events in my experience which set up the result.

MOBILISM/i'd been analytically working out with an old friend named dan a new life style we were calling "mobilism." it involved paring your idea of "house" down to the simple, painful minimum & putting one unit on the East Coast, one in the Midwest & one in northern California. each unit was to be simple, superdurable like an anvil & casual about complicating factors like insulation & middle-class weatherproofing. the three locations allowed some compensation for this simplicity by letting you follow the benign weather as it occurred in each area rather than overbuilding only one shelter determined by the worst weather encountered in just one place. our individual head-reasons for these projections were pretty interesting. i was moved by warm climate & traveling, but the best hook for me was that this scheme fitted my hope & fantasy of beating the system. it was early nomadics, moving like a desert man over the land without subscribing to what seemed like antilife nonsense of thirty-five years of mortgages & time clocks. dan's thoughts had even a more compelling base. what could be more bravely human & appropriate than a guy in a wheelchair working out a life of movement? he got polio in the Navy & was left with a remnant 10 per cent opposable thumb fortunately buttressed with a fine far-ranging mind & a truckload of guts. he did anthropology & hung on to bang out of the Congo with a van full of precious woodcarvings a few hours ahead of Belgian mercenaries in that era when Patrice Lumumba was tossed in the ditch. i miss his company. i think he's out in Davis doing something academic & making citizens crazy by looking slightly like a merry Lenin who made it.

OFF THE SHELF/about this time i started to wonder if the kind of unit i spoke about to dan might be built of three or four simple existing components by assigning them new uses to build a shelter system without starting from ground zero in terms of fabrication. it seemed this approach would make new systems really accessible to more people at less cost with more personal involvement, since they would do assembly.

CHOOSING COMPONENTS/i was working for a guy putting hydraulic dump bodies on grain trucks & the flat bed we used was great; industrially produced with a steel channel underframe & edge, supporting heavy 2" timbers for the bottom. i worked out a system of horizontal planes on various levels supported by vertical utility poles on a modular grid. the whole structure had a barnlike roof (from hitching through Pennsylvania) & wind-rain panels at strategic points. i'd dream of crawling out of a sleeping bag on one of the high platforms into the sunrise & washing up with the breeze drying my skin; a primate in his Platonic tree.

FURTHER ON/i didn't get to build that one but later i translated the idea into 2x2's because i got on to lightness & demountability by then. no foundations, just tension members & canvas roofing. that was the father in the series. the last one is here, indelibly labeled "the Fun House" by an ingratiating magazine editor who persisted in saying "far out" when he meant "how odd!" this outdoor Living Structure can go on your own land when you are opening it up, on short-term-leased land or on a friend's land in a tentative way. it's a base camp for hiking, fishing or just witnessing the wonder of Earth. decks get you off muddy ground & the sleeping volume gives a place to dry out when you hit rain for a day. the Matrix is a total reference frame which gives shelter & handy spots to dry wet gear, air sleeping bags or hang a string of trout. the cooking cabinet keeps things together & the table is to hang out at.

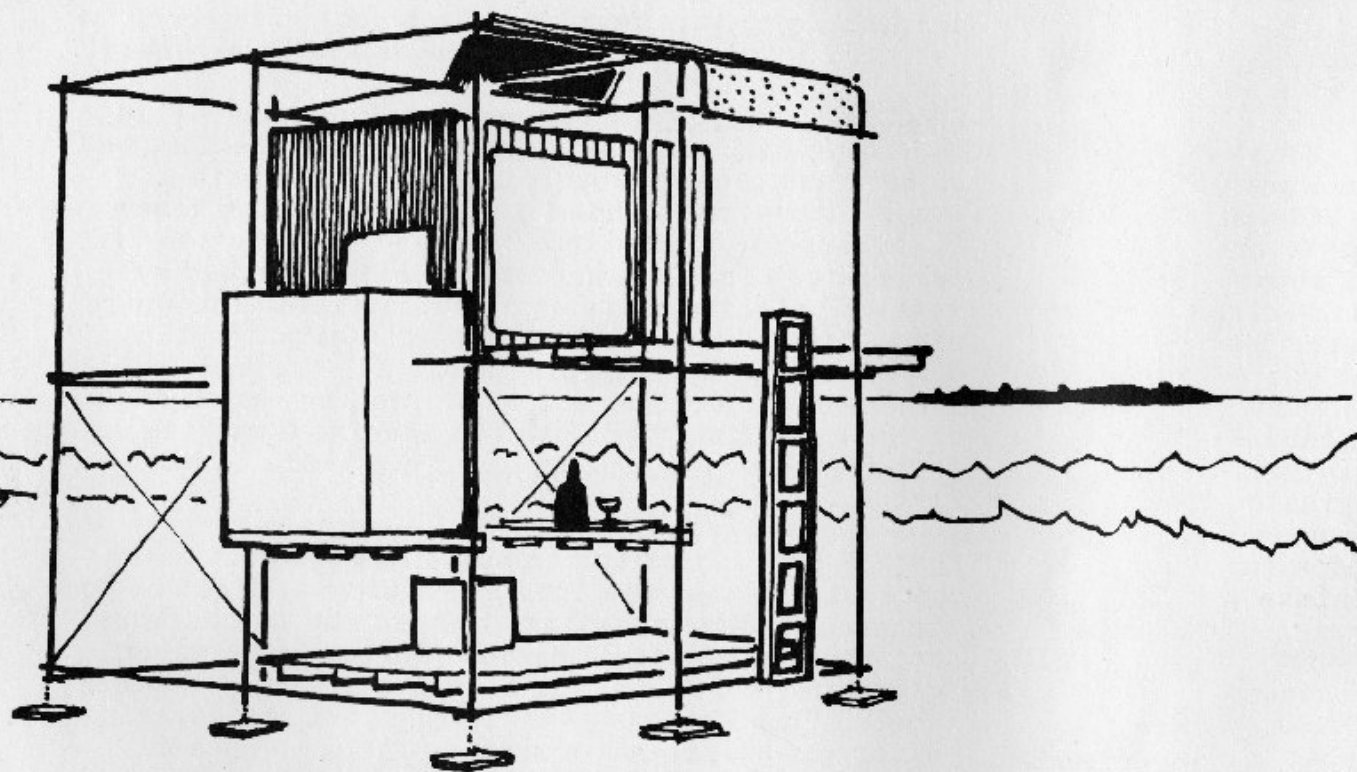

BUILDING THE MATRIX/the network is the basis of the structure. it's made of 27 lengths of 1" pipe (real outside measure is about 1 5/16"). these can be connected with any of the several temporary scaffold-type joint fittings now on the market. i can't recommend the ones we used because they were made for us by a neat little lady near Cleveland who has since retired. see p. 83 for alternative.

THE PADS/these are 11 1/2" waterproof laminated plywood squares. use a waterproof glue like Resorcinol to sandwich the two 3/4"-plywood pieces & drill 1 1/4"-diameter holes in the top pieces before gluing to accept the leveling screws. we cut the 1" threaded rod into 18" lengths & put the large washer between a hex nut & the pipe end.

GETTING IT UP/level the sand or earth in 9 spots & place the pads level to begin. assemble 3 planes of 6 pipes each, then tilt up & hold 2 of these in position on pads. put in 3 or 4 transverse horizontals to make it stand, then just continue. two people can do it fine because i did it alone one time on the beach at Westport. pads give good bearing area on the ground & the leveling screws equalize slight variations & changes in ground level.

## BEACH MATRIX

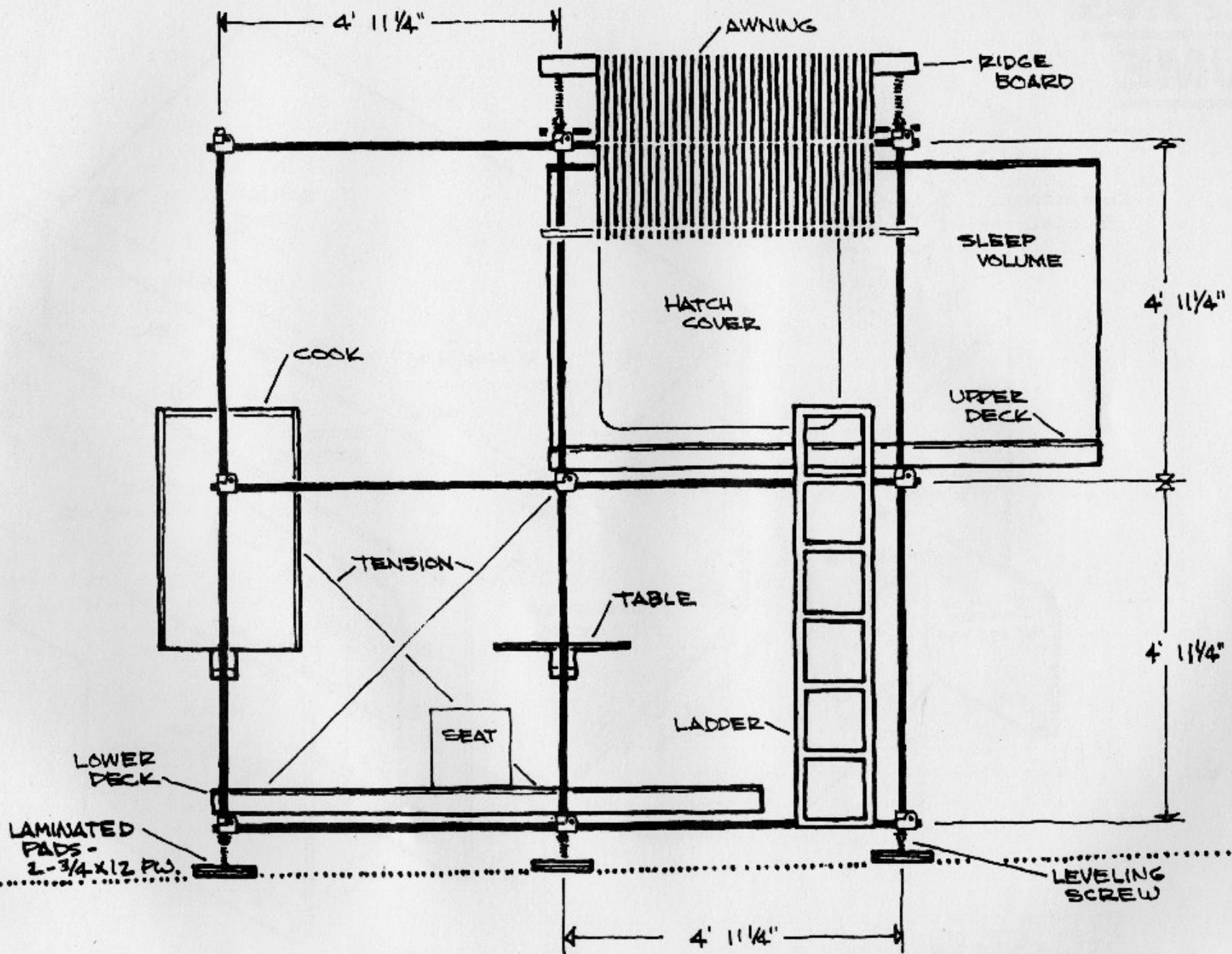

# SLEEPING VOLUME

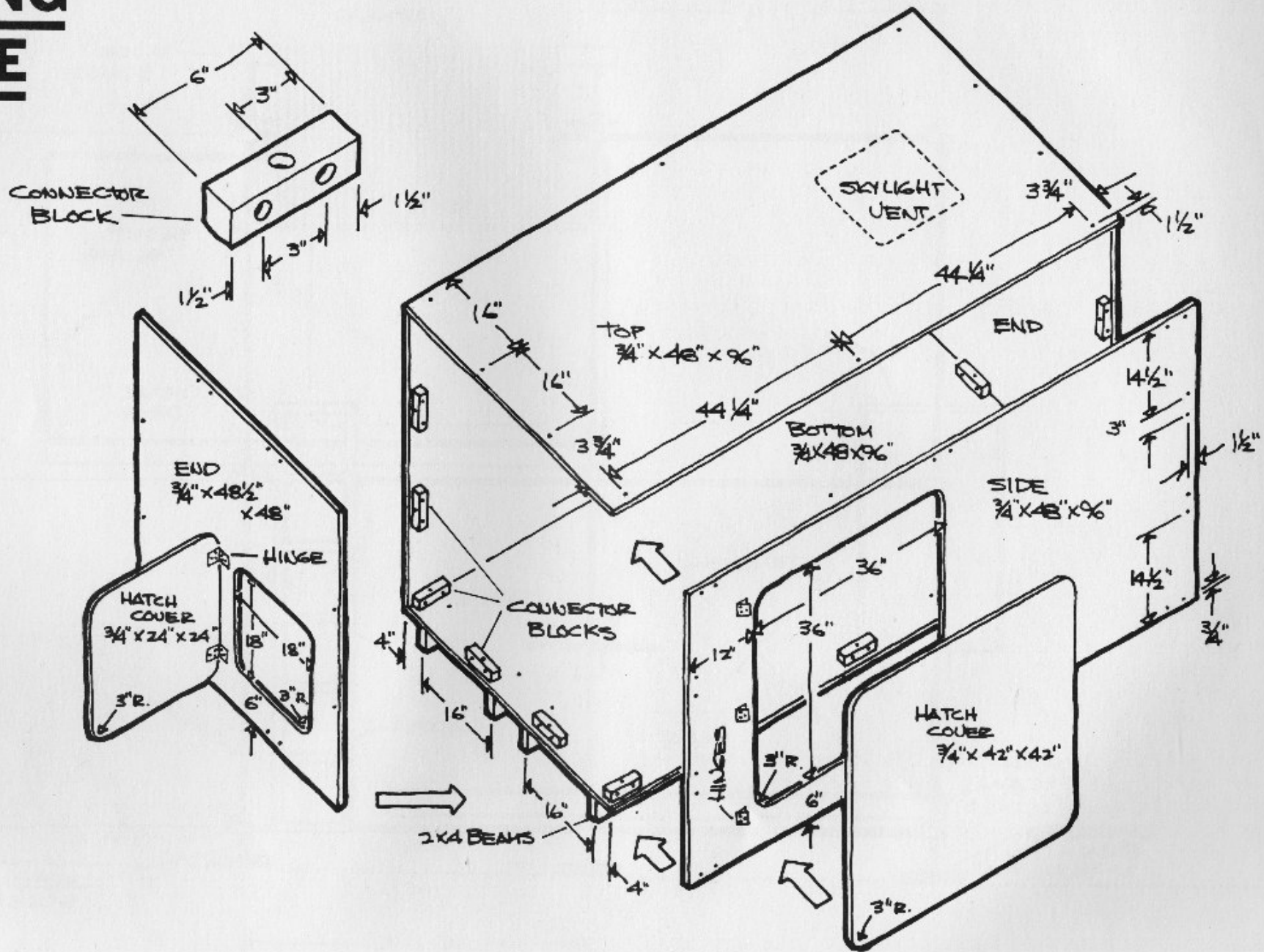

SLEEPING VOLUME/cut the sides from 3/4" exterior-type fir plywood using either handsaw or portable electric saw & clamped Masonite straightedge. stack & gang-drill the ends together, then the two sides & then top & bottom together. the last pair is tricky: use clamps & move the little drill stand to the hole, holding down on the base with left hand & using right to pull drill through the wood (base is reversed). all holes are 5/16" diameter & countersunk outside for 1/4"-20x2" flathead machine bolts (connectors are counterbored for nuts & washers.) bolt the bottom to 2x4 beams like decks, then put up sides with top & ends last. cut hatches & covers with saber saw, clamped hardboard straightedge & radius bar. apply foam gasket around opening so hatch cover compresses it for a tight seal. we put storage shelves in the blank end for gear, books & folded clothing. i think the clear plastic skylight-ventilator is a necessity for pleasure & air. staple nylon screen on small hatch.

COOKING CABINET/this simple box is made of 3/4" exterior plywood with a back of 1/4" (stiffened by shelves). the parts are screwed & glued together in the old-culture way. sounds funny for me because it counters my directions for demountability, but it seems good now & then to check your intense feelings by trying it out again from the polar point of view. it works OK this way but is bulky when moving. anyway, the three vertical door panels are piano-hinged together & close against foam gasket applied to the face edge of the cabinet. place the magnetic catches strategically to hold the door closed. the twin beams underneath hold the cabinet in position while you run the horizontal pipe member through it. make the 1 3/8"-diameter hole with an expansion bit & a hand brace. don't forget the clamp blocks under the cabinet either. you may want to modify the shelves for your gasoline stove & equipment. we used Coleman stuff & this worked very nicely.

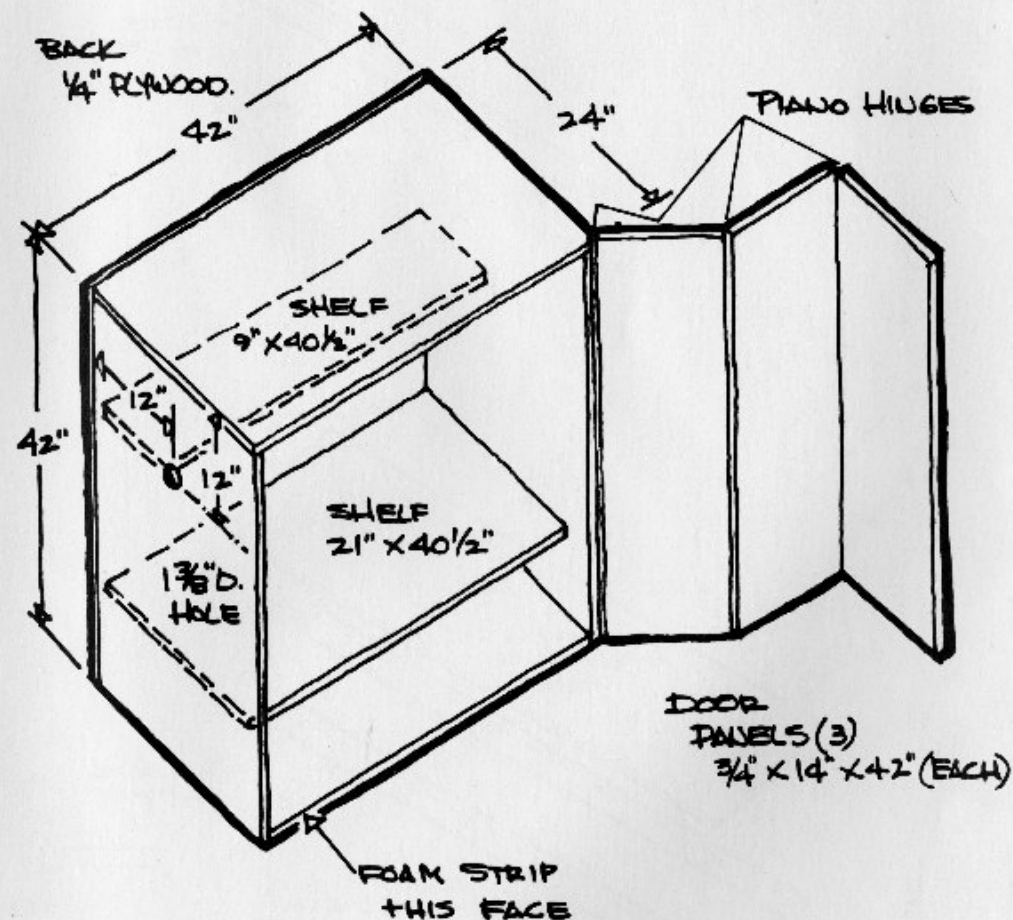



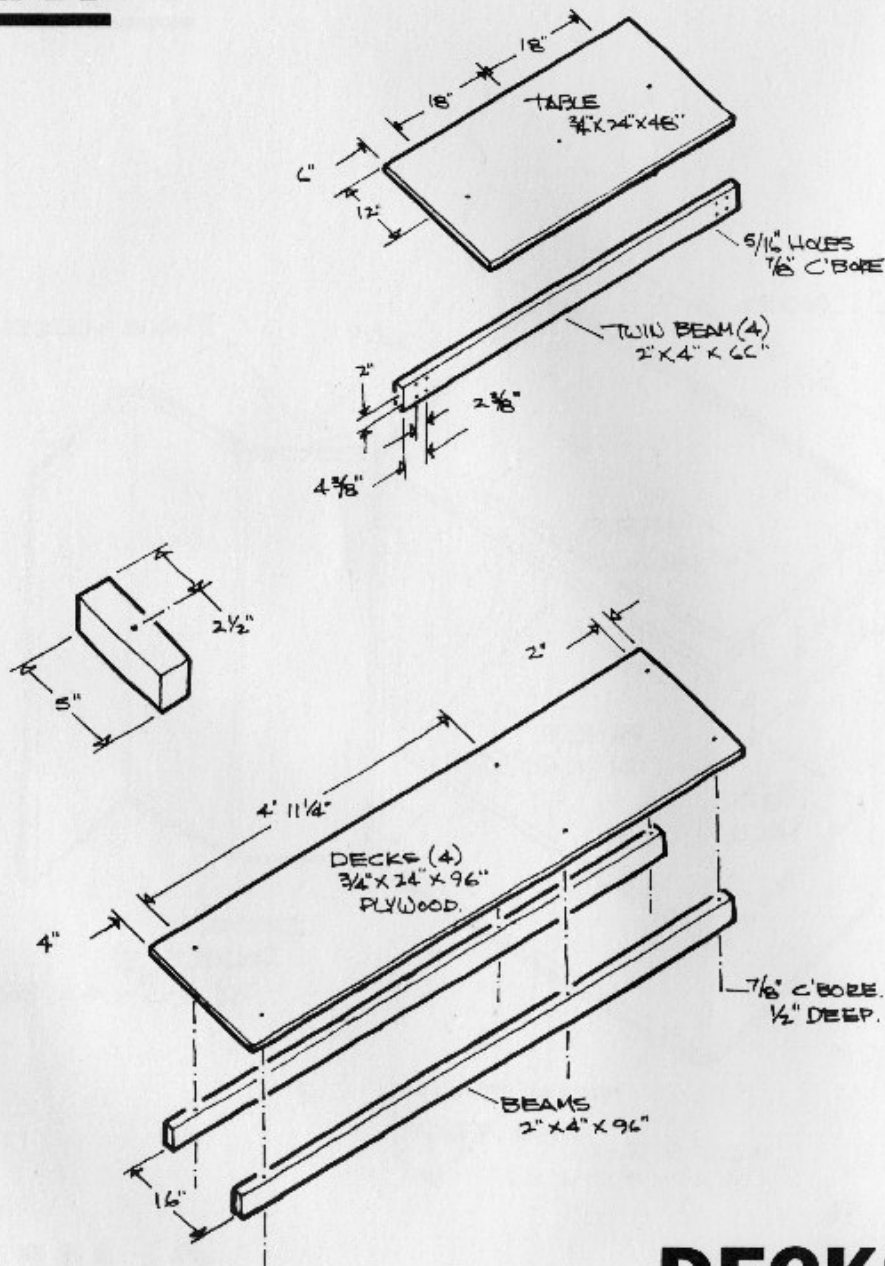

## DECKS

TWIN BEAMS & TABLE/select four straight & dry fir 2x4's. cut to 66". lay out & drill pieces individually. do the counterboring first. then do the 5/16" holes for the 4" hex-head bolts. two beams clamp on two vertical pipes with the bolts doing the clamping. don't pull too tight. the table is 3/4" plywood, 24"x48", with 3 countersunk holes on the centerline (see drawing at left, top) for the 5 1/2" flathead bolts to the clamp blocks. hand-tighten all bolts, then level & center parts before using wrenches to snug up.

DECKS/there's no substitute for exterior Douglas fir plywood. 4'x8' sheets of 3/4" are carefully ripped right down the middle. these are pallets. 4" flathead bolts fasten panels to a pair of 2x4's with 7/8" counterbores on the underside of all mounting holes. detail on page 82 shows how electrical stand-off clips are used to secure the pallets to the Matrix.

FINISHES/blocks and all parts with the fine aluminum oxide paper. we used acrylic outdoor paint in green, yellow & orange over white undercoat for cooking cabinet, table & twin beams. everything else was natural with two or three coats of boiled linseed oil, laced with turpentine for penetration. remember to wipe off all excess oil. if you don't it stays sticky & collects airborne dust & vegetable matter. it's a mess.

TAPES/the sleeping volume can be sealed, after finishing with either aluminum weatherproof self-stick tape or clear polyethylene tape. the aluminum tape is a little more difficult to get on smooth but it sure is durable. either should keep the volume dry & snug.

LADDER/we built this up fairly conventionally using 2x4's fixed with Resorcinol (waterproof) glue & screws. safety is a big thing with a ladder so this work must be done carefully. i think you should use long pan-head sheet-metal screws through the verticals into the steps. these do not taper like wood screws but have a uniform thread diameter. choose a drill bit (after counterboring for screw head & oversize hole through the vertical) a hair larger than the screw diameter minus the thread part & then it will make its own threads in the wood as you turn it in. the large clothesline hooks may have to be opened a little to accept the horizontal pipe but don't overdo it. try for really square cuts on the pieces so they assemble without gaps for weather to get into.

AWNING/support this with a 2x4 ridge 66" long with 1" holes 2 1/2" deep to slip on the 1" threaded rod stuck in the tops of the two vertical pipes. hex nuts & washers position the 36" rods. the 48"x96" bit of canvas has open seams on both short sides with 66" pipe lengths stuck through. the weight of these pipes was sufficient to position the awning in any but the heaviest blow & has the advantage of great simplicity. i've considered situations when it would be good to have over-all cover & this can be worked by making three ridge 2x4's each 12' long to support a 12'x16' rectangle of polyethylene tied down on two opposite sides to the middle outside horizontal. water drainage could be promoted by tying two nylon lines over the poly sheet & down to two top opposite horizontals thus creating two valleys between the ridges.

THINK/all drawing & photographs only show one reality or set of relationships using the components. the Matrix is open to many other possibilities. respond to your own dialectic.

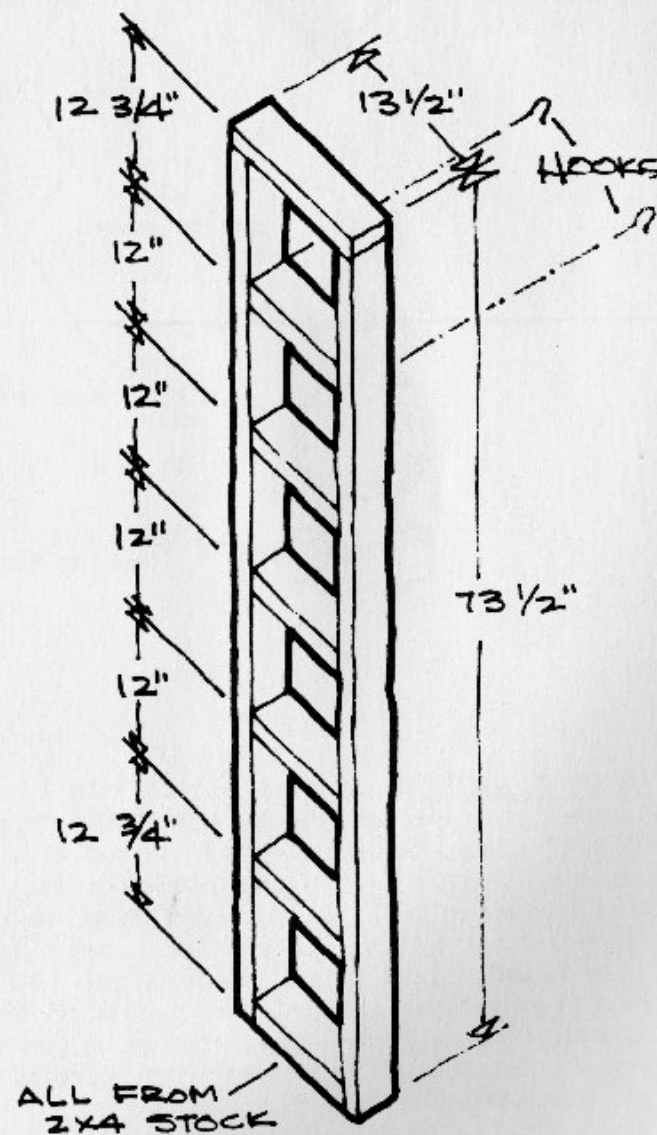

# TENSION

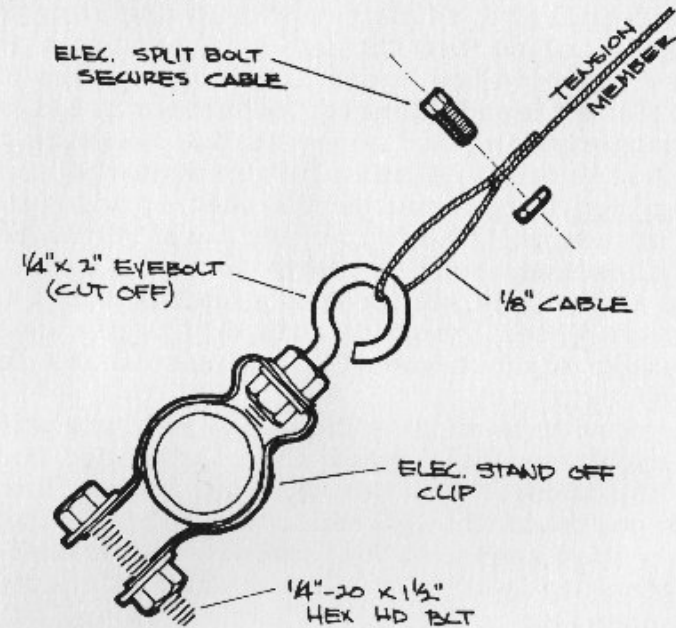
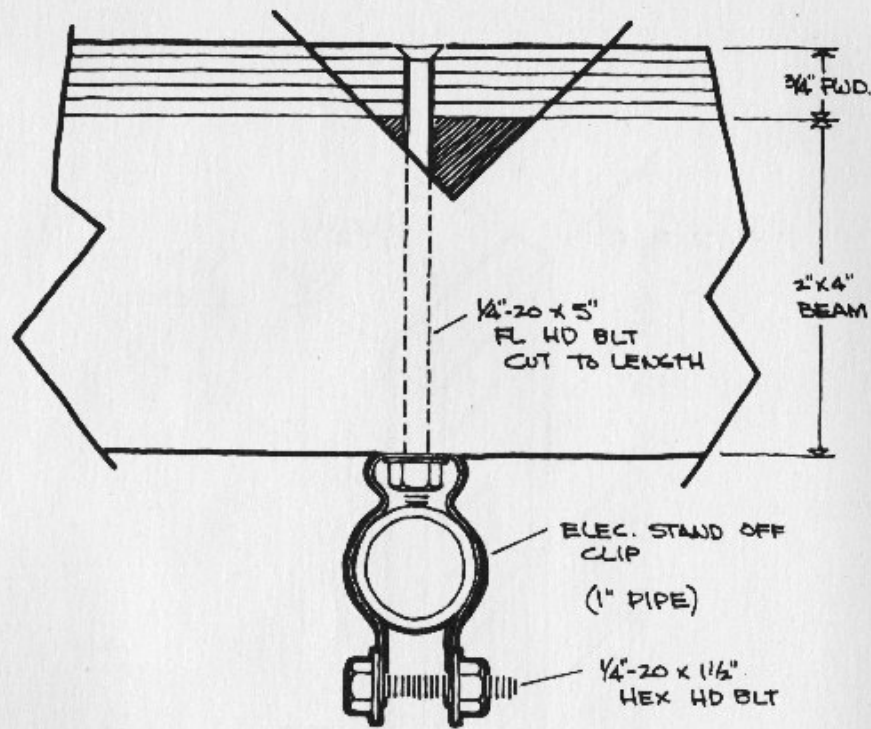

FASTENING DECKS TO MATRIX/the neat little old lady in Cleveland used to make us great cast fittings for securing 2x4's to pipe, but since she went out we've had to develop an alternative. it's based on an electrical conduit stand-off clip. what you must do with accuracy & care is cut off the 5" vertical bolt so the bottom (threaded) end almost touches the top of the pipe. this helps support vertical loads on the stand-off. dimensions & contours of these clips vary slightly so set this one up yourself with scraps so you are sure before cutting all the bolts. experiment with small, easily managed scraps of plywood, 2x4 & pipe until you can really see & measure it.

this detail may also be used to fasten wind & shade screen planes to the vertical pipes in the Matrix.

TENSION MEMBERS/some elements of a structure have weight pressing down on them, tending to crush or squash them. this is called a "compression member," as would be the waiter's arm when he holds a heavy tray of dishes over his head. another kind of loading is called "tension." when you carry a bucket of water by the bail, your arm is being stretched by the weight. it is in tension. the lightweight aircraft-cable tension members here make the structure more rigid & taut like a finely rigged sailboat. this cable has loops formed in its ends, held by the smallest electrical split bolts. cut the eyebolt shank short to fit in the stand-off & open the eye to accept either the cable loop or the end of the turnbuckle (which allows adjustment of the cable tension-don't overdo it here or you'll have a mouthful of wires). these fit on the 1" pipe sticking outside the joints. use two sets in each of two modules.

### CUT PARTS/

27 pcs. 1"x10'4" galvanized pipe  
2 pcs. 1"x66" galvanized pipe  
4 pcs. 3/4"x24"x96"  
4 pcs. 3/4"x48"x96"  
2 pcs. 3/4"x46 1/2"x48"  
1 pc. 3/4"x42"x42"  
1 pc. 3/4"x24"x24"  
18 pcs. 3/4"x11 1/2"x11 1/2"  
1 pc. 3/4"x24"x42"  
2 pcs. 3/4"x24"x41 1/4"  
1 pc. 3/4"x24"x40 1/2"  
1 pc. 3/4"x9"x40 1/2"  
1 pc. 3/4"x21"x40 1/2"  
3 pcs. 3/4"x14"x42"  
1 pc. 3/4"x24"x48"  
1 pc. 1/4"x42"x42"  
12 pcs. 2"x4"x96"  
5 pcs. 2"x4"x66"  
2 pcs. 2"x4"x72"  
6 pcs. 2"x4"x10 1/2"  
1 pc. 2"x4"x13 1/2"  
28 pcs. 2"x2"x6"  
6 pcs. 2"x2"x4 7/8"

### HARDWARE/

9 pcs. 1"x18" plated threaded rod  
2 pcs. 1"x36" plated threaded rod  
36 pcs. 1/4"-20x4" flthd. blts.  
24 pcs. 1/4"-20x5" flthd. blts.  
32 pcs. 1/4"-20x1" hex hd. blts.  
84 pcs. 1/4"-20x2" flthd. blts.  
32 pcs. elec. conduit stand-offs  
8 pcs. 1/4"-20x1/2" hex hd. blts.  
8 pcs. 1/4"x2" eyebolts  
4 pcs. 1/4"x6" turnbuckles  
30' 1/8" wire cable  
8 pcs. smallest elec. split blts.

Matrix  
awning  
decks (pallets)  
sleeping volume  
sleeping volume  
lg. hatch cover  
sm. hatch cover  
pads  
cooking cab (top)  
cooking cab (sides)  
cooking cab(bot.)  
cooking cab (shelf)  
cooking cab (shelf)  
cooking cab (door)  
table  
cooking cab (back)  
beams (deck)  
twin beams & awning  
ladder (sides)  
ladder (steps)  
ladder (top)  
connectors  
clamp blocks

leveling screws  
awning support  
plywood to 2x4's  
decks to Matrix  
stand-offs  
connectors (sleep. vol)  
decks & tension members  
tension members  
tension members  
tension members  
tension members  
tension members

### HARDWARE CONTINUED/

11 pcs. 1" hex nuts (washers) leveling screws  
3 pcs. 3/4"x42" piano hinges cooking cab (door)  
8 pcs. magnetic catches cooking cab (door)  
5 pcs. 2" backflap hinges hatch covers (sleep. vol.)

### MISCELLANEOUS/

1 1/2" flathead wood screws  
2" sheet-metal screws  
waterproof glue  
48"x96" hemmed canvas  
1/8"x1/2" closed-cell self-stick foam  
large clothesline screw hooks

NOTE/i know it's repetitive, but remember that all metal hardware has to be plated bright to stand up in the real world of sun, rain & temperature changes.

ALTERNATIVE JOINT FITTINGS FOR PIPE/the fitting that is most like the ones used in our Matrix Structures can be purchased from the McMaster-Carr Supply Co., P. O. Box 4355, Chicago, Ill. 60680. it is shown on page 41 of their catalog No. 79. it is listed under (L)#4698Y69 (for 1" pipe). the price is \$4.55 each. this is a three-way symmetrical joint cast of "high-strength, lightweight, aircraft quality aluminum alloy which meets ASTM, SAE, Federal & Military Specifications." because it is made of aluminum it is relatively non-corrosive so it might have some advantages over our original. it has two set screws per pipe & each fitting is rated "at more than a ton of holding power."

from this information i sure wouldn't hesitate to use it & we're going to test some at Groveland soon. these guys are very good suppliers but don't stand back from shopping around in your own area because you might get a better price, since you need almost thirty of the units.

# MATERIALS



**SUPER**  
**CHAIR**

CONFLICTS/there's never been any uncertainty in my head about the idea that all new life designs must be based on a more real set of assumptions & objectives than those motivating the present orgy of production. my inner conflict has revolved around the question of whether it's better to attempt new actions from the center of the system or to work more on the outskirts. a little isolation from the old-culture obsessions with big-money/big-power seems to give me very precious liberty. it becomes apparent that concrete & inventive living responses, undistracted by cultural fantasies, are the best approach to the problem of survival. the big-deal attack is sometimes very seductive though. it panders to the Western idea of self & holds out the promise of quick, easy results. the truth is that propaganda efforts to encourage slowdown in consumption are a lot like trying to get a shark to eat with a knife & fork.

WITHDRAWAL & RETURN/my resolution of the conflict was to spend long periods at Groveland building, thinking & scraping the mud off my boots. periodically i returned to the urban centers, usually because some one individual showed a desire to nourish the Matrix Idea. you can't respond to a corporation but you do to a person even if you lack faith in some of the premises.

DAVID & LEONARD/david was a quick, generous N.Y.C. guy interested in Living Structures & Microhouses. he sent me to leonard, who ran a big bookstore on Fifth Avenue. leonard was diversifying from books into Picasso plates & Bantu necklaces so he allowed as how he could sell a reading light of special design if he had it. this wasn't exactly a clear mandate for a Structure but i got down to work & built the prototype Superchair anyway. leonard sold quite a few i guess even though his fabrication was grisly & his prices astronomic. i learned something valuable.

STARTING/Superchair is not a structure built of all universal members like some of the others, but the bones do have a high degree of correlated hole patterning & lengths. the clearest way to begin is to cut to length, drill & test-erect the basic twelve-member Matrix. once you get this you can fabricate the other parts in related groups, bolting them in as you finish them. this will keep your whole operation together & prevent mistakes. all the bolt holes are 5/16" diameter except the four acting as pivots between the seat & back. these are 1/4" holes for precise hinging action without play or slop. it's slightly tricky to get the pivot bolts in place but hang on. don't forget the two washers between facing 2x2's to cut friction. counterbores are generally 1/2" deep made with a 7/8"-diameter speed bit in the drill stand or a wood auger bit in the hand brace.

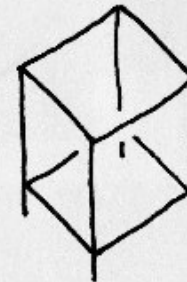

CUSHION/you might want to resolve this part before getting totally immersed in the construction. the one in the prototype was kind of elaborate. it had a foam rubber core, rounded with Dacron fiber & tufted. the cover was black leather. the seat was made separately from the back & the two segments were hinged together by a leather strip. the cushion was not attached to the panels. some people have built them with squared-off foam & simple box covers of vinyl or canvas. this seems fine & is less expensive.



CONSIDERATIONS/it's probably an OK idea to round the long edges of the 2x2's with the fine section of the rasp. actually all the Structures benefit from this operation. it cuts down on splinters & snags. use cap (acorn) nuts as indicated & wherever threaded bolt ends protrude. we always use lock washers on the flat washer (under nut) to keep them tight.

TUNING/most wood structures in this country are subject to central heating, meaning high temperature levels & extreme dryness. wood shrinks a lot & assemblies get loose. bolts should be snugged up every couple of months. the best wrenches for the counterbored holes are called "Spin Tites" or "socket-drivers." they look like screwdrivers with a hollow socket instead of a blade on the business end. get the 7/16" size for 1/4"-20 hex nuts.

TENSION MEMBERS/two pairs of cables with turnbuckles go in the lowest rectangle of each side frame to resist stresses resulting from loading on the back. replace the 2 lower 2 1/2" bolts in each frame with 4" eyebolts. just above these (between armrest 2x2's on each side) drill & counterbore holes for 2 1/2" eyebolts. open the eyes to admit turnbuckles & cable loops. make the cable loops with electric split bolts.

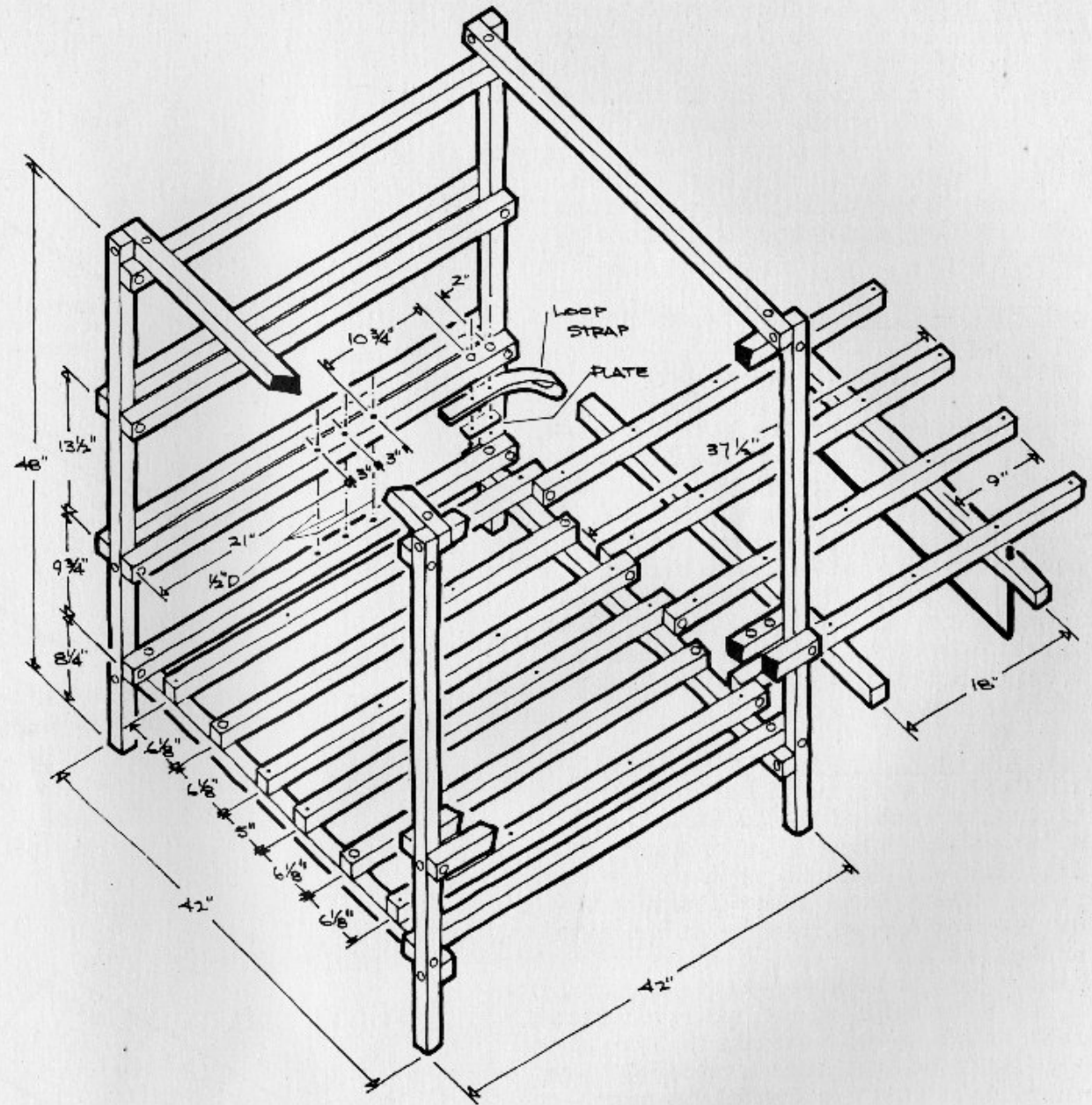

## BONES





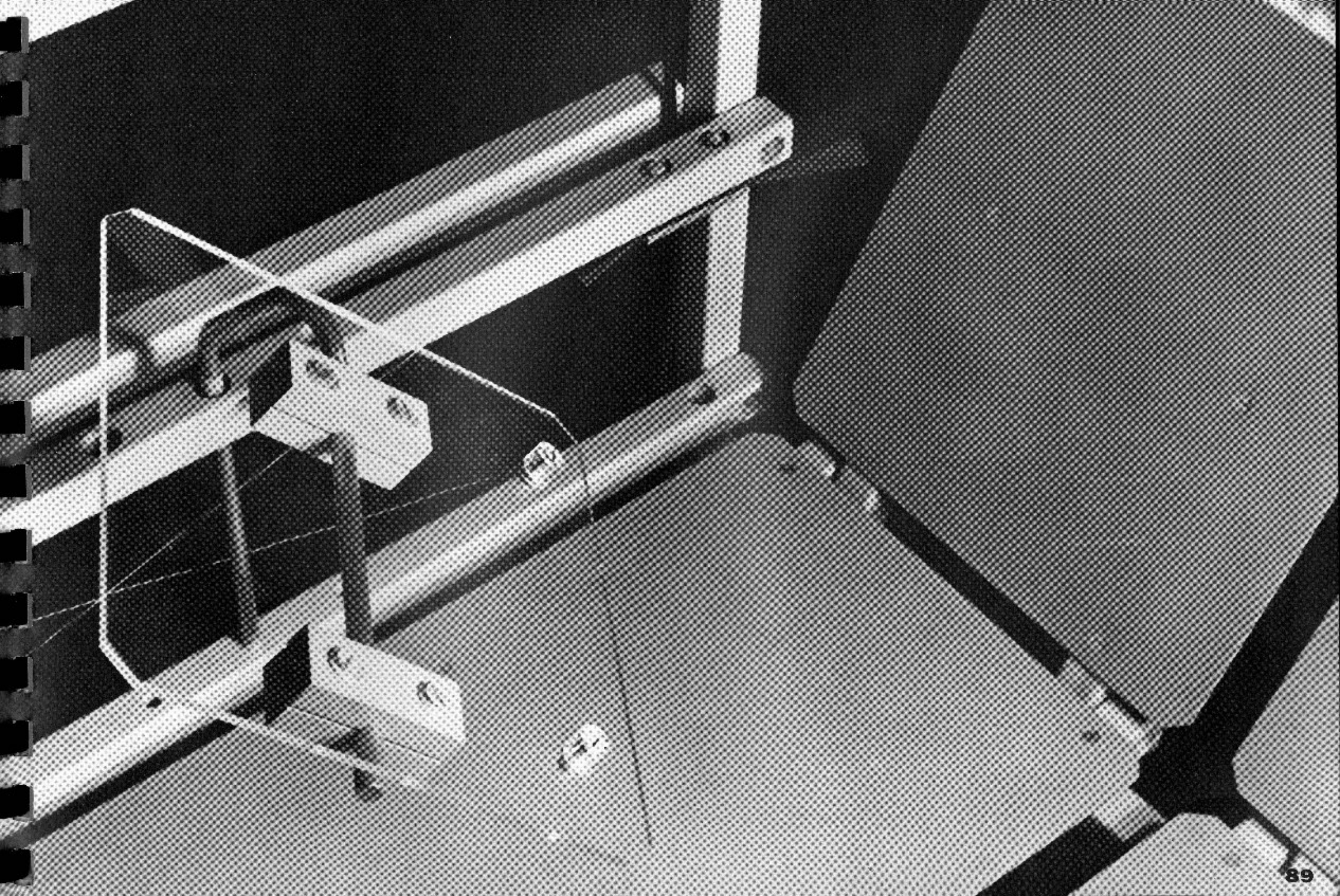

# LAMP

THE LAMP CHASSIS/use the hardboard panel as a guide & drill the two  $38\frac{3}{4}$ "-long  $2 \times 2$ 's. counterbore these holes  $\frac{7}{8}$ " diameter  $\frac{3}{8}$ " deep. the fluorescent fixture is a common garden variety undershelf kind. ours measured  $1\frac{1}{2} \times 4\frac{1}{2} \times 18$ ". discard the bent plastic shield that comes with the light & through the top of the sheet-metal body drill two  $\frac{5}{16}$ " mounting holes  $10\frac{1}{2}$ " apart. drill & counter-sink mating holes at appropriate spots in the panel. mount the panel on the  $2 \times 2$ 's with the 3" flathead bolts. then secure the fixture between the  $2 \times 2$ 's with  $\frac{1}{4}$ " flathead bolts. cut these off short to eliminate interference with the bulb.

FINISH THE GRID/cut the plastic grid (Sears is the good source to buy this stuff) to size with a 40¢ fine-tooth keyhole saw. make a cutout to get your finger in to the switch. smooth all edges with a fine flat metal file & blocksand. put a stack of nine washers on each bolt sticking out from the bottom of the chassis. lay the grid over these bolt ends & washer stacks, then secure with washers under cap nuts. the grid will now float free beneath the  $2 \times 2$ 's & the width of it will keep the assembly from sliding off the top of the frame. rewire using the heavy cord & plug because the furnished cord is junk.

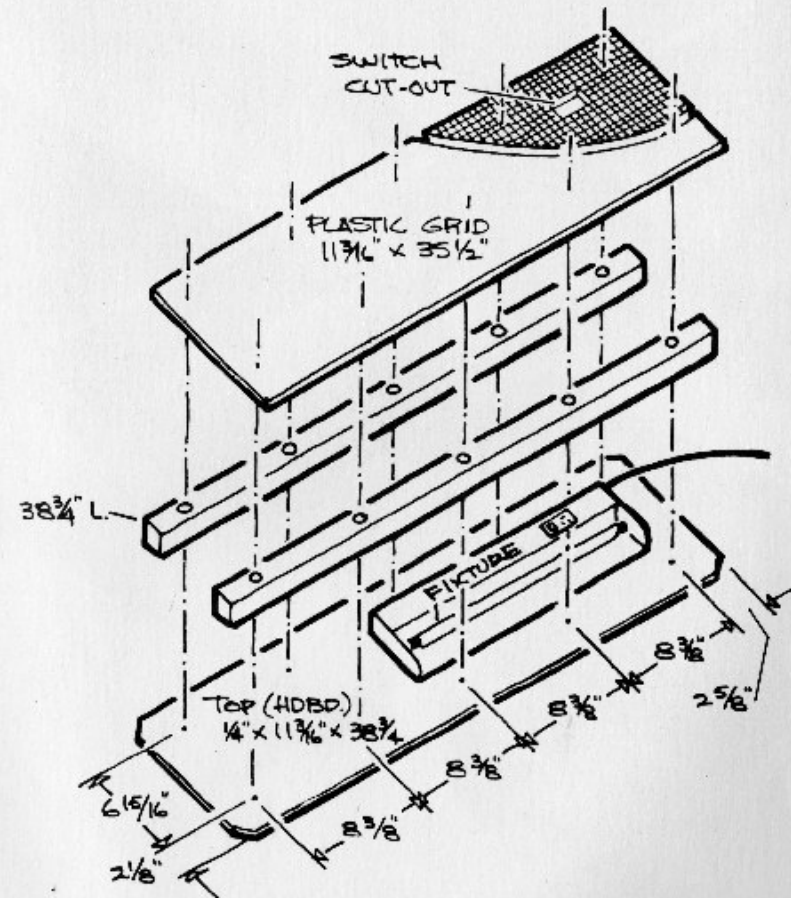

MOVABLE ROUND TABLE/we used a 15" circle of white Carrara marble with a 10" piece of  $2 \times 2$  wood glued to the underside with Elmer's glue. two  $2 \times 12$ " strips of felt are glued on both sides of the block to decrease friction when the table slides on the supporting members. the weight of the marble results in stability combined with good sliding action because of inertial effects.

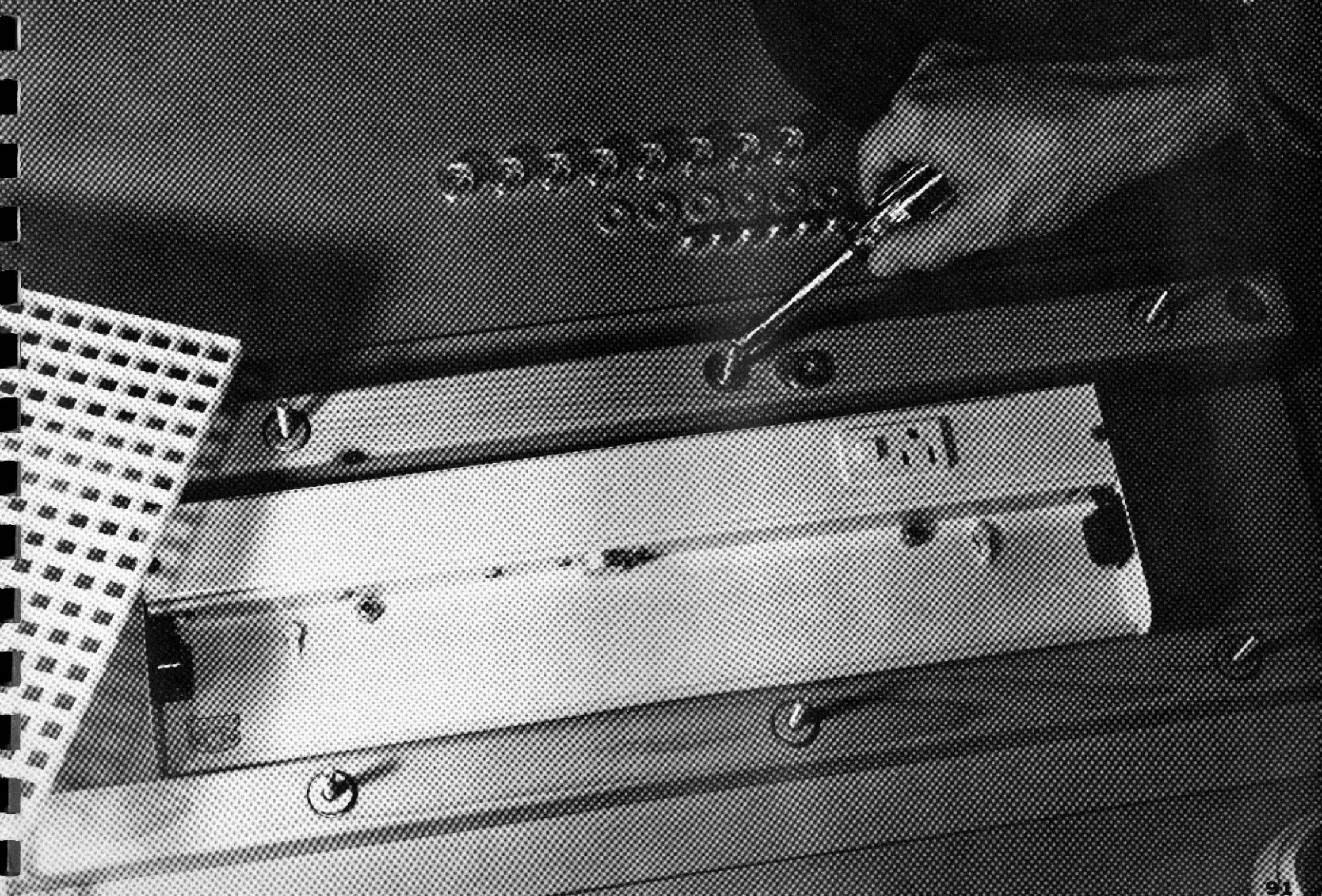

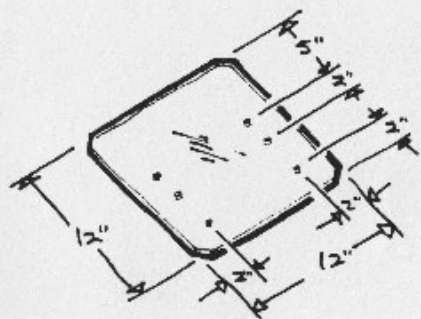
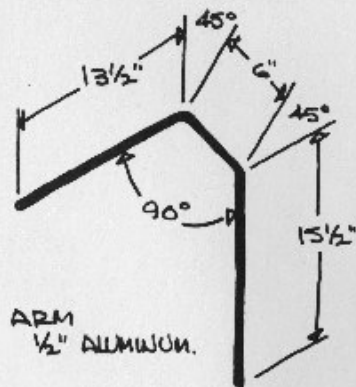

READING REST  
1/4" CLEAR  
PLEXIGLAS.

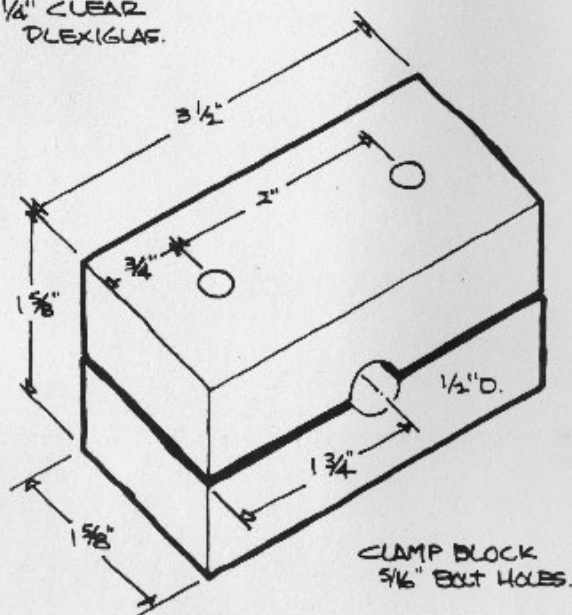

CLAMP BLOCK  
5/16" BOLT HOLES.

BOOKREST ARM/bend this arm from the 1/2" aluminum rod. if you want the rest to fold back parallel to the bookshelves (completely out of the way), put a 30° bend (see p. 89) in the top part. remove burrs, polish & then insert it in any of the three 1/2" holes in the right hand armrest 2x2. retain it at a good level for you by using a shaft collar above the lowest 2x2 framing member.

PLEXIGLAS PANEL/you can cut this stuff with the fine-tooth keyhole saw, a saber saw (with acrylic blade) & clamped straightedge, or on a table saw. the 1/4" thickness cuts nicely. run the flat metal file very religiously on the edges to nix tooth marks of sawing. then blocksand & close by polishing the edge with a soft cloth & any ordinary tooth powder. it has a fine abrasive in it that doesn't scratch the soft acrylic. nip the corners at 45° like the other panels & countersink the 1/4" holes. to prevent scratching, leave the adhesive paper masking on the Plexiglas during all these tooling operations then remove it as the last act. to make the stops that prevent books slipping down, stack six or eight washers on 1" hex-head bolts & mount in the two bottom holes in the panel. put cap nuts on underside.

CLAMP BLOCKS/pick a 12" or 14" piece of clear, sound 2x2 scrap. lay out holes & cutting lines (allowing for the saw kerf between pieces) in sharp No.2 pencil. drill all holes, then rip to split leaving some of the original piece intact so the whole thing doesn't fall apart. cut to length very carefully the last thing. assemble with Plexiglas panel on the arm with four 2" flathead bolts. don't overtighten. panel should still tilt for moment-to-moment adjustment with just hand pressure.

### CUT PARTS/

- 4 pcs. 2"x2"x48"
- 14 pcs. 2"x2"x42"
- 4 pcs. 2"x2"x40 1/2"
- 6 pcs. 2"x2"x38 3/4"
- 4 pcs. 2"x2"x37 1/2"
- 2 pcs. 2"x2"x3 1/2"
- 2 pcs. 1/4"x15 3/4"x38 11/16"
- 2 pcs. 1/4"x15 3/4"x35 1/2"
- 1 pc. 1/4"x11 3/16"x38 3/4"

Matrix verticals  
 Matrix horizontals  
 & shelves  
 seat supports  
 lamp, seat & back  
 horizontals  
 back verticals  
 clamp blocks  
 seat panels (hd bd.)  
 back panels (hd bd.)  
 lamp panel (hd bd.)

### HARDWARE/

- 32 pcs. 1/4"-20x2 1/2" hx. hd. blts.
- 6 pcs. 1/4"-20x4" hx. hd. blts.
- 4 pcs. 1/4"-20x2" hx. hd. blts.
- 20 pcs. 1/4"-20x1 3/4" flthd. blts.
- 26 pcs. 1/4"-20x3" flthd. blts.
- 4 pcs. 1/4"-20x1" flthd. blts.
- 4 pcs. 1/4"-20x2" flthd. blts.
- 4 pcs. 1/4"x2 1/2" eyebolts
- 4 pcs. 1/4"x4" eyebolts
- 124 pcs. 1/4"-20 steel hex nuts
- 300 pcs. 5/16"IDx3/4"OD med.-wt.  
steel flt. wash.
- 100 pcs. 1/4" Split-Spring  
lock washers
- 24 pcs. 1/4"-20 cap (acorn) nuts
- 4 pcs. 4" turnbuckles
- 1 pc. 20' of 1/8" wire cable
- 8 pcs. smallest elec. split blts.
- 5 pcs. 1/2" shaft collars
- 1 pc. 1/2"x8' round aluminum rod
- 2 pcs. 7/16" socket-drivers
- 4 pcs. 1 1/2" Bassick plated  
furniture glides

Matrix & pivots  
 shelves  
 belt loop & plate  
 seat & back panels  
 lamp, seat & back  
 book stops & lamp  
 bookrest panel  
 tension members  
 tension members  
 general use

general use

general use  
 where noted &  
 as necessary  
 tension members  
 tension members  
 tension members  
 leg (bookrest)  
 leg (bookrest)

COUNTERSINKING/this tool cuts  
 a cone section from the hole.  
 this allows the top (slotted)  
 face of flathead bolt to  
 fit down flush with the  
 face of a panel.

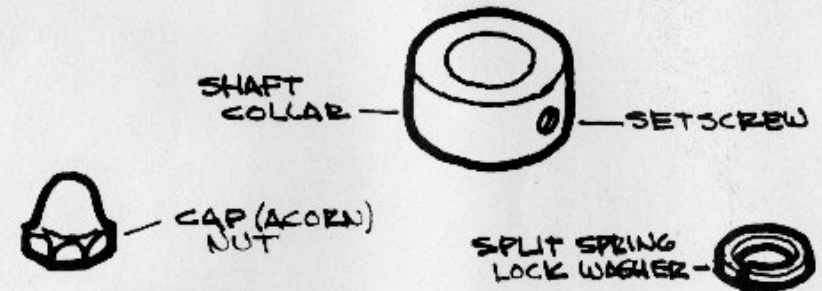
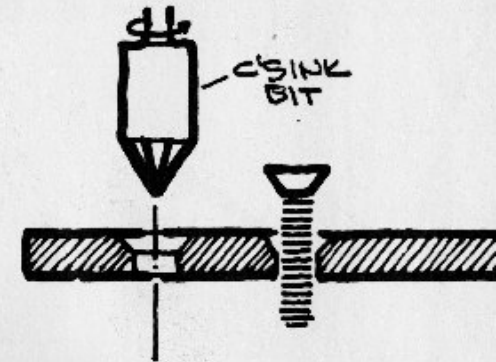

FINISHING/the 2x2's go good with a natural finish  
 like Firzite & loving rubs. i painted the hardboard  
 a durable flat mustard color with a roller. a short  
 nap 7" roller is the next best thing to spraying.  
 if you get sensitive & take time it turns out ex-  
 tremely consistent, slightly textured surfaces. don't  
 try to hurry & load it all on in one coat. use white  
 primer first. concentrate on even coating. use  
 light pressure on the roller because all tools  
 seem to work best if you don't push them.

TIMING/hub, who built & designed the Unipak Vehicle,  
 took approximately one weekend to cut, drill & fab-  
 ricate the parts for a similar structure. i think  
 he used a second weekend to sand & finish every-  
 thing. but he has a really high skill level so  
 maybe most persons should allow a little more time.

# MATERIALS

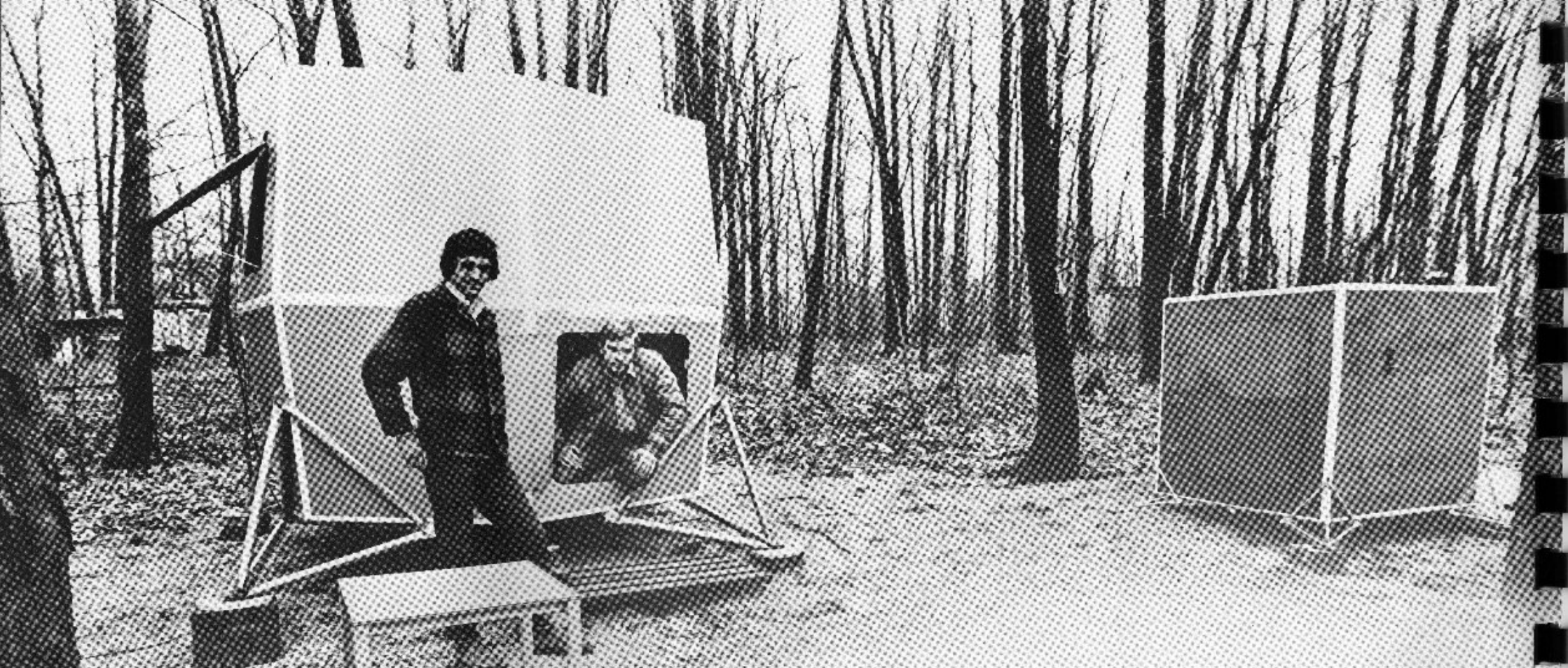

## **8' MICROHOUSE**

WHEN i was first discovering & applying the Matrix Idea i couldn't help wondering why people had to shackle themselves to some kind of corporate clerkship for twenty years to get the money for a home in the country. why wasn't it possible to apply your best consciousness & information to develop a new shelter? it had to be compact & mobile using a minimum material list & buildable in your apartment with simple tooling. fabricate the parts in winter, slip into a van or wagon in spring & trek to a short-term-leased spot on a farmer's back 40 & set her up in a day. it's kind of like "freedom now" instead of waiting until you can "afford" it. living put off is lost.

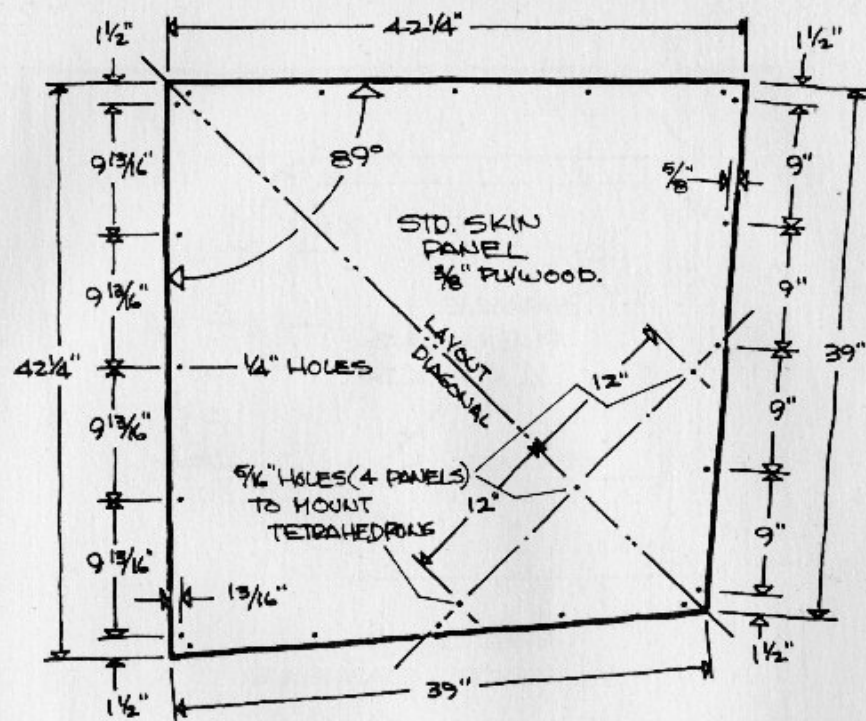
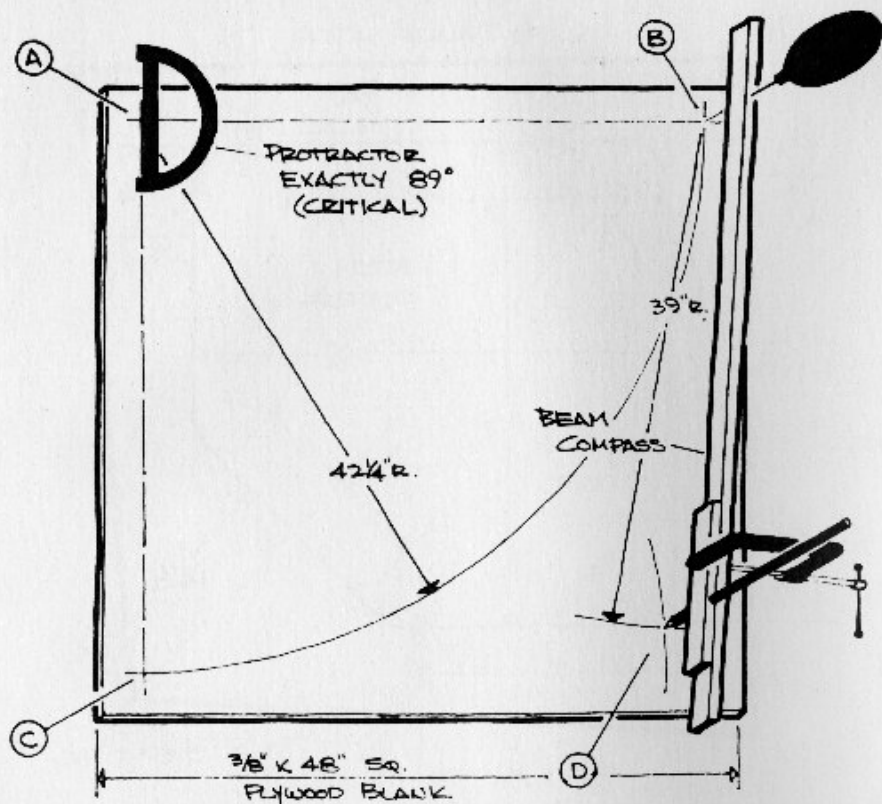

MAKING THE PANELS/the shell is unframed exterior plywood only 3/8" thick. it's lightweight & strong put together with corner angles just like the Panel Matrix (p. 58). use a protractor, beam compass (p. 51) & great care to lay out one Master Panel. measure one 42 1/4" length (line AB) then mark another 42 1/4" length (line AC) at an 89-degree angle to it. set the beam compass at 39" & strike two arcs intersecting at point D with centers at point B & point C. use a good straightedge to connect the points. double-double check it & clamp this Master Panel on top of two 48" blanks.

CAREFULLY/gang-saw, guiding portable electric saw against a clamped Masonite straightedge. if OK, use Master Panel to mark around remaining blanks then gang-saw all 24 skin panels, 2 or 3 at a time. gang-drill 1/4" holes for joining angles 6 panels at a time. distance from edge should match your corner angles (mine were 5/8"). add 3/16" to this dimension along joints where skin panels join interior panels. use electric drill in stand. lay out openings, then cut individually with guide & fairly high-speed saber saw.



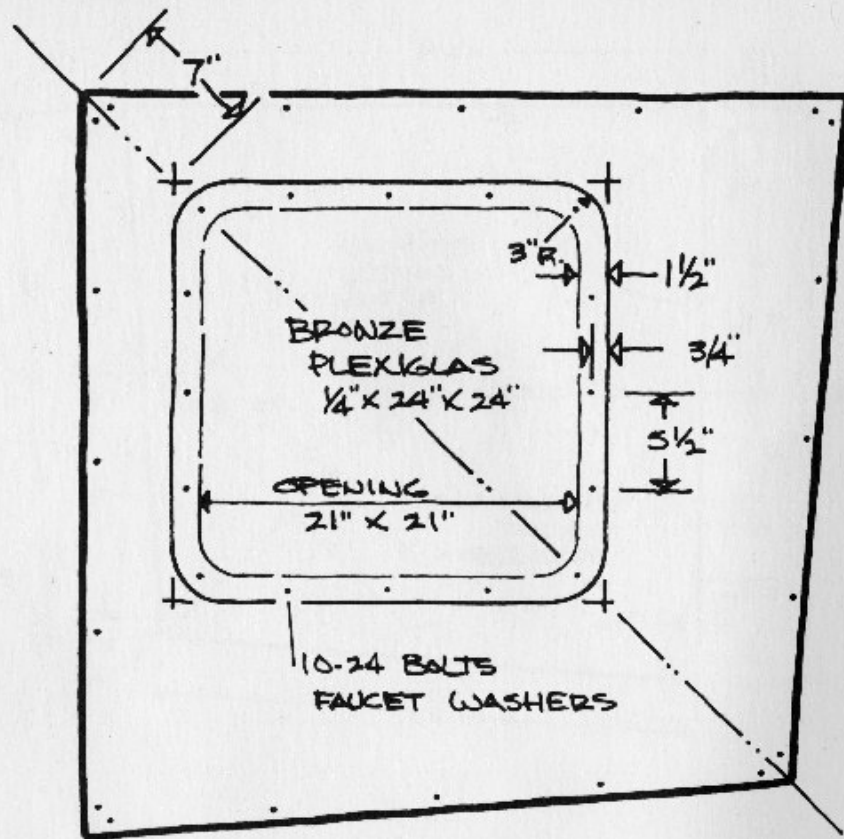

WINDOWS/use lightest bronze tint 1/4" Plexiglas. it's beautiful & cuts solar heat. saber-saw blanks then lay out hole pattern on protective paper. buy a twist drill sharpened for plastic (sharp angle point). remove paper & use Plexi as pattern to drill plywood panel. be careful, holes are 1/4" so plastic can expand & contract. 3/8" neoprene faucet washers go under bolt heads for cushioning plastic. lock washer & double nut but don't overtighten. lay silicone sealer bead last. one window by food area to watch quail run while cooking, one low under sleep surface to watch ants & one as a skylight to watch the stars while falling asleep is not bad.

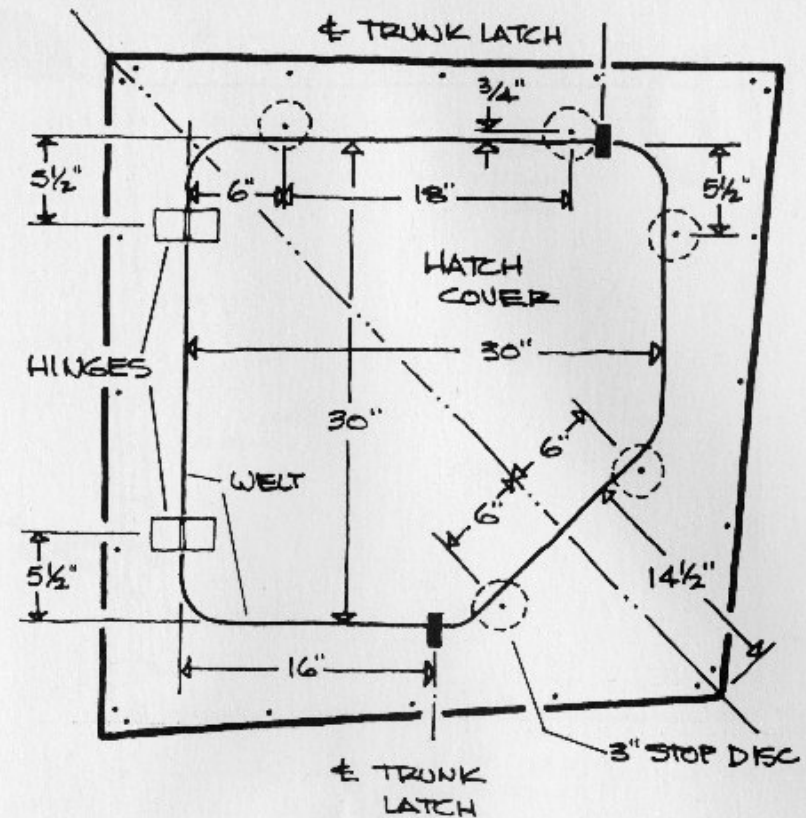

HATCH DETAILS/using clamped straightedge & radius bar with saber saw, cut precise 1/8" strip from entire perimeter of cover. staple & cement plastic welting to new edge. using a pile of six or eight washers on each hinge bolt, raise hinge off surface so welt is not crushed. do the same with bolts holding trunk latches. put lock washers & double nuts inside to prevent casual unscrewing from outside. use 1/4"-20 flathead bolts & 3" stop discs. 1/4" holes for hinge bolts allow movement for careful centering but drill latch-bolt holes for close fit on 10-24's. locate chopped, turnable 3" latch discs to serve as locking device from inside.

INTERIOR PANELS COME TOGETHER the twelve inside panels guarantee safety & strength like the taut bulkheads in an ocean-racing hull. they also function as the "furniture" for sleeping, sitting, shelving & space division. nine have openings for movement & flow. lay out, drill & saw using the same techniques & manic concentration as on the skin.

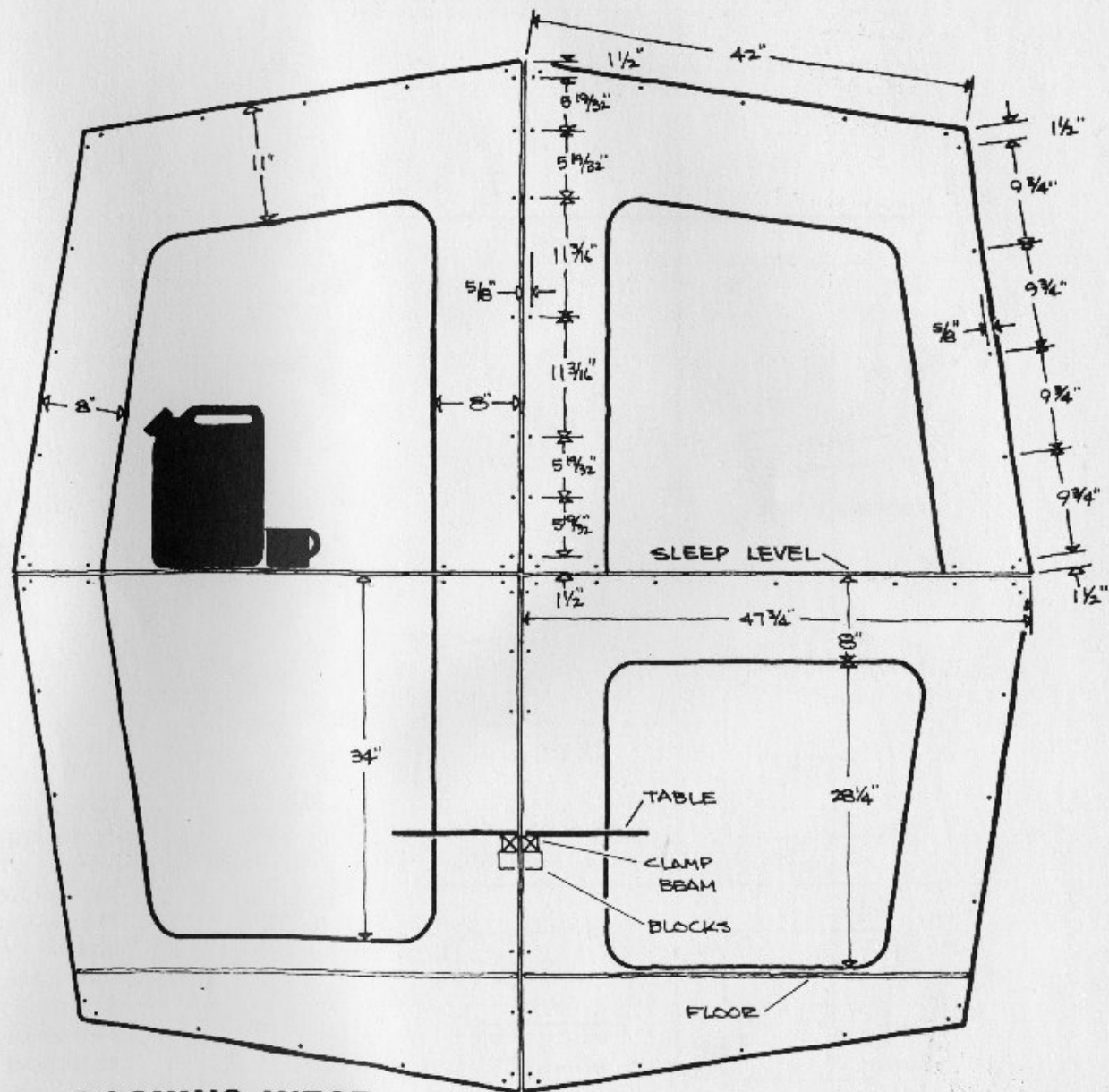

LOOKING WEST

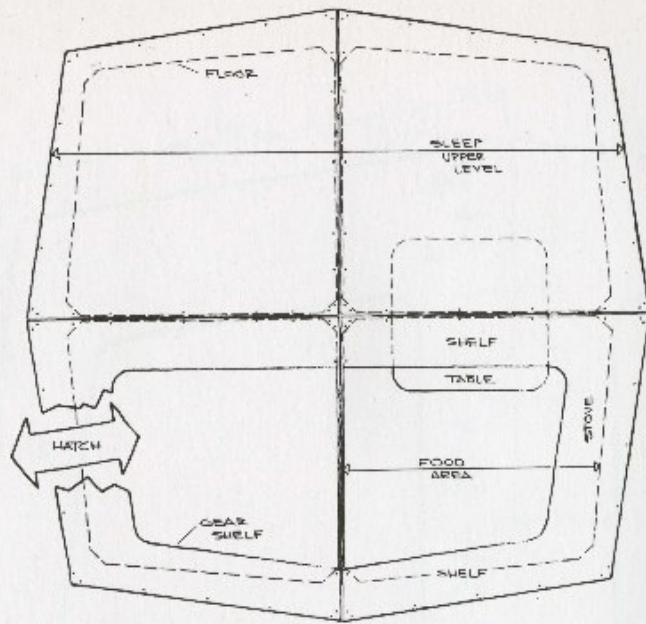

LOOKING DOWN

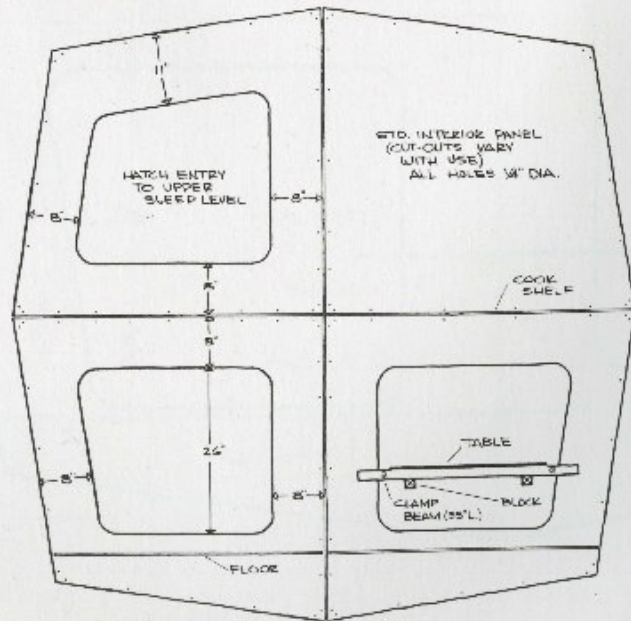

LOOKING NORTH

TABLE/cut top from piece sawed from one of the openings. support it with two 33" lengths of 2x2. these clamp on the sides of hole in the low interior panel next to the food area. drill & counterbore holes for clamp bolts 4" from each end. locate the exact center of the 24"-square table top (by drawing the two intersecting diagonals) & drill a 1/4" hole there. round the corners for antisnag. put a 4" flathead bolt through this hole, between clamp members into the 2"x2"x4" block. this block locks the table top in place. adjust to a comfortable level for you & sit one person on each side on a floor cushion. glue naugahyde scrap on top for easy cleaning.



INSIDE/chuck leans  
in the entry hatch  
of his Microhouse  
& you can see how  
inside panels work.  
cut-out horizontal panels be-  
come shelves & sleeping level.  
we used it last winter in about  
1° below zero with the \$25  
electric heater & it wasn't bad.

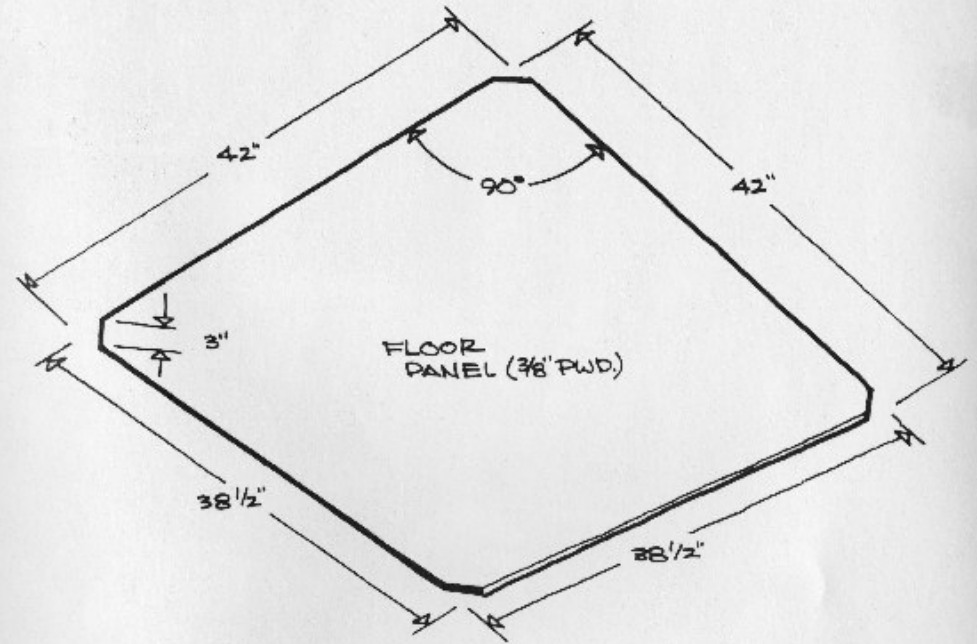
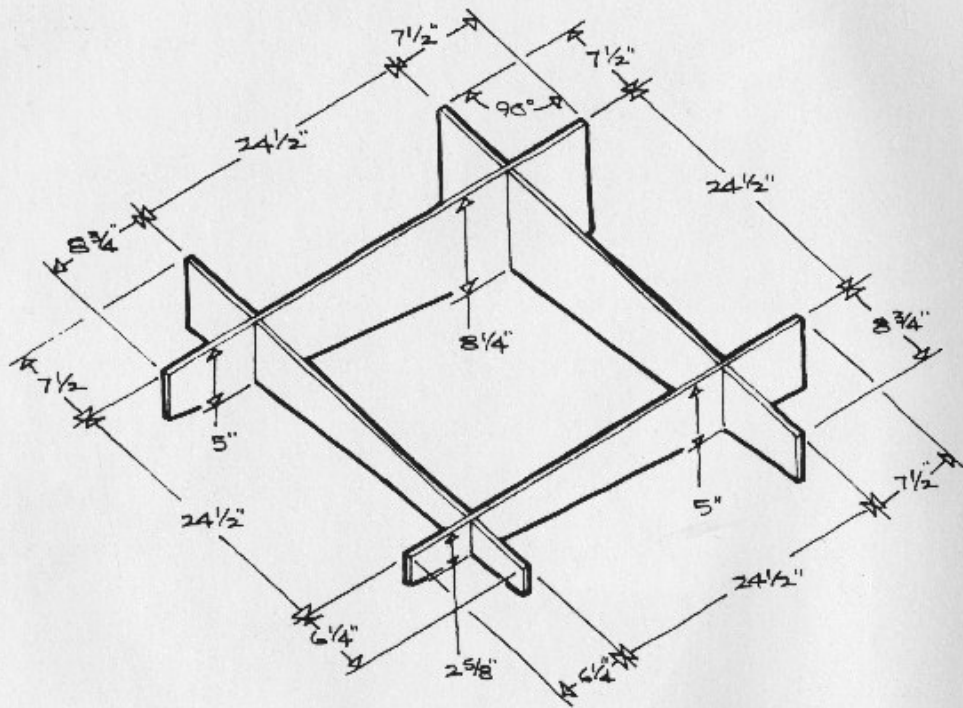

# FLOOR

FLOOR/four separate floor panels are used. cut them as drawn, using beam compass to complete the two short sides. nip corners on a line perpendicular (90 degrees) to the diagonal. the four pieces that make up each of the four support grids are slotted together egg-crate fashion. get an accurate sliding-not binding-fit.

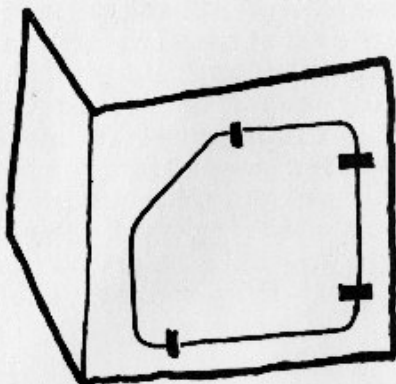

**1**

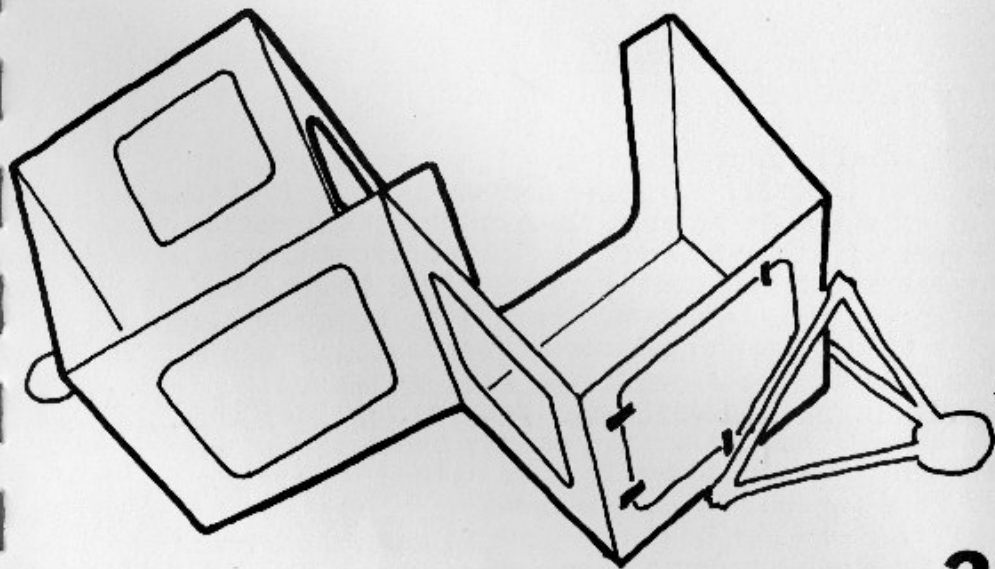

**2**

SITE ASSEMBLY/after you pick a place that's profound & beautiful to you, with a little tree shelter from winds & some good sun exposure, minimally cleared of weeds & brush, prepare spots for each leg pad to hit. they are all level, so block up those needing it on cut wood, gravel or flat rocks. rake organic debris & loose topsoil away from the area of the structure & about 4' on each side. use rake & muscle to make the ground flow evenly & smoothly from one part to another. this helps drainage. then spread 2" of pea gravel on cleaned space. assemble the four lower corners separately & upside down. do Tedlar tape on outside shell corners. bolt on legs using large "fender" washers inside under nuts to prevent them pulling through. short edges of skin panels join with 98-degree corner angles. the 89-degree corner angles link the skin panels to the insiders where they come together. inside panels fasten to each other with unaltered 90-degree corner angles & 10-24 roundhead bolts. altered angles are bent in a vise with a hammer & heavy pliers. do one of each type perfectly, then use it as a pattern to bend the rest. use socket-drivers to slowly draw the 10-24x3/4" flathead bolts up. the heads will sink into the plywood until they are flush with the outside surface.

ADDING/place two diagonally opposite bottom quarters on the site, blocking them with scrap wood at the center. additional blocking may be necessary at other points to line up the sections so you can join them along the vertical (mating) edge of the inside panels. don't hurry the subassemblies into "nearly" correct position & try to force them while bolting. you can't force people & you can't force Structures. listen & feel it & place blocking so parts really do line up. this will save time & a burned brain. bring some 12" squares of old rug or carpet to put between blocking & shell bottom to save dinging it all up under there. it's not a bad idea to have a 20'x20' polyethylene tarp handy in case of rain, then if you get caught, you can cover parts & coffee-talk it out.

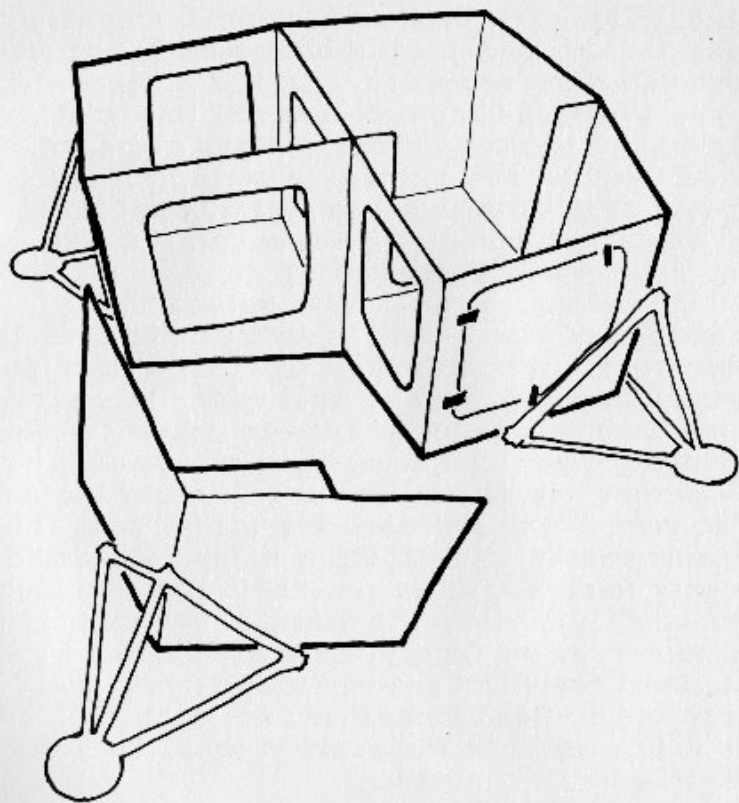

3

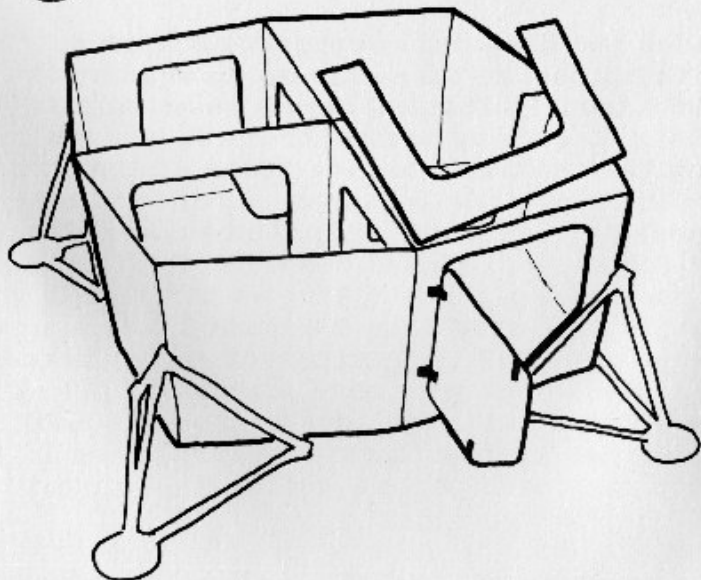

4

COMPLETING LOWER HALF OF SHELL/set the two remaining lower corners in place, line up & block securely. this shell is so crazy that it won't achieve the phenomenal end strength until fully assembled. so avoid overstressing or standing in it because of this vulnerability. if you find some bolts impossible to reach from outside, it's best to put a floor grid & floor panel in one (or both) of the first two corners assembled. this will distribute your body weight over a wider area. be Calvinistic about checking each line of nuts for tightness as you go. it's negative to leave loose bolts behind you. this weakens the Structure.

DROP in all floor grids. lay floor panels on top of them. neither of these components is fastened in. it's simple to rest them on the shell bottom & works just fine. add the four horizontal panels at the shell midpoint. now the shell begins to get pretty rigid so you can lift it from one side at a time to get crawl room underneath to tape the bottom joints. exercise real care when blocking in this position, despite the fact that it's just temporary. the safety issue is big even though the Microhouse is only raised 10" or 12". if it's insecure & gets bumped off, you can get hurt. be sure to have a partner around when you do this one because the idea of Microhouses is to help people, not hurt them.

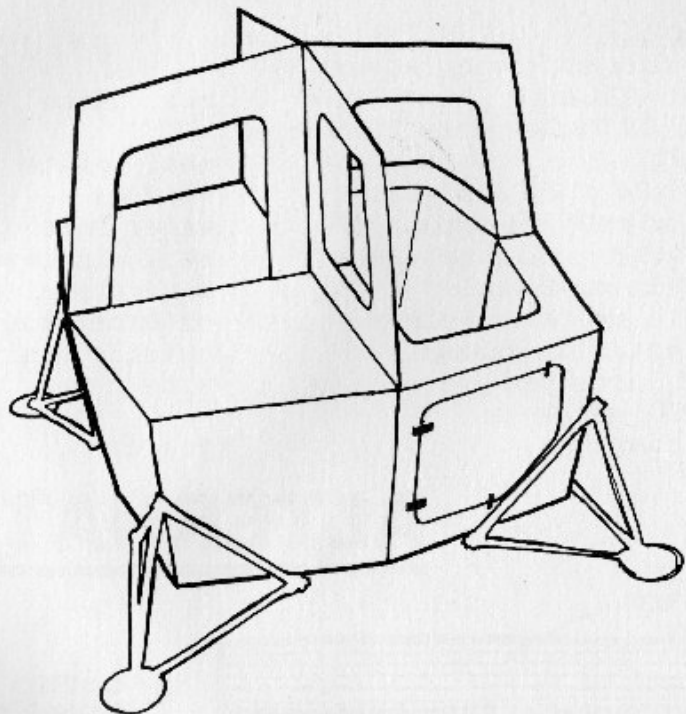

**5**

DOING THE UPPER HALF/the next operation is to get the four top inside panels bolted in place. the one between the sleeping level & the food area is a blank with no openings, but the other three have cutouts. if you have a little wind, bolt two panels that go at right angles together at their vertical joint. this will form a more stable L shape that will stand up without blowing over while you bolt it.

HATCH WATER SHIELD/the 1/4"x6"x42" clear Plexiglas is bolted into the joint above the hatch panel. it runs water off the shell which would tend to run inside at the top of the hatch. replace the 3/4" flat-head bolts in the lower edge of the upper panel with 1" roundheads. trick is to tape it first, punch holes in tape for bolts, then run a bead of silicone sealer between top edge of Plexiglas & upper panel for final seal.

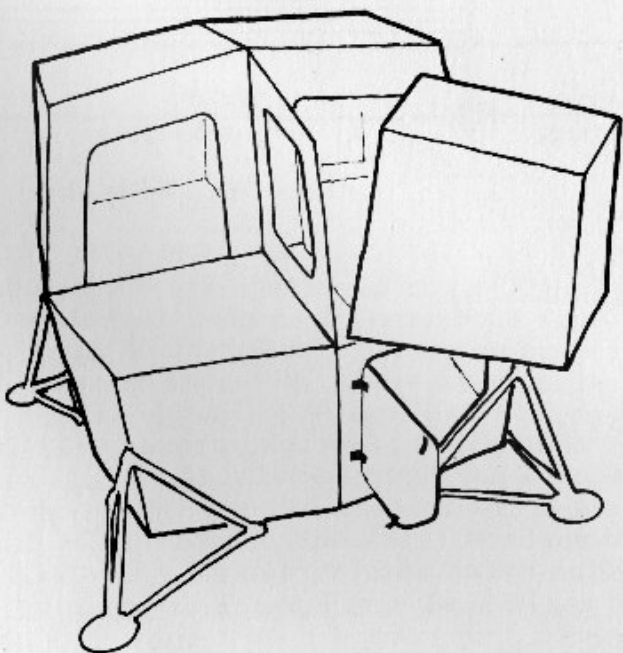

**6**

FINAL TOUCHES/preassemble (on ground) the four upper shell corners. place them one at a time, being careful not to skin everything up if a corner slips. the last corner may turn out to be a real nightmare, especially if you haven't been a good careful person in all the previous steps. if you have a little scare on the fit, just be calm & breathe deeply. backtrack & loosen some nuts on joints near the problem area & try to massage it all together. a lot of people have done it & so can you. when it's all satisfactorily together, tape joints from bottom up, "shingling" (overlapping) tape segments for watertightness. center tape on the joint it seals.



## WOOD/

- 21 pcs. 3/8"x48"x96" Ext. A-C DFPw.
- 1 pc. 3/4"x36"x36" Ext. A-C DFPw.
- 1 pc. 2"x2"x72" Douglas fir

## HARDWARE/

- 240 pcs. 1"x1" corner angles altered to 98°
- 120 pcs. 1"x1" corner angles altered to 98°
- 150 pcs. 1"x1" corner angles 90° as bought
- 650 pcs. 10-24x3/4" flthd. blts.
- 60 pcs. 10-24x1" rndhd. blts.
- 700 pcs. 10-24 hex nuts
- 50 pcs. 3/8"ODx3/16"ID neoprene faucet washers (flat)
- 8 pcs. 1/4"-20x1" flthd. blts. & nuts & washers
- 2 pcs. medium-size trunk latches & fasteners (blts.)
- 2 pcs. 2" backflap hinges & fasteners (blts.)
- 12 pcs. 1/4"-20x1 1/2" hx. hd. blts. & nuts & washers
- 4 pcs. 1/4"-20x2" flthd. blts. & nuts & washers
- 12 pcs. 1/4"-20x2 1/2" hx. hd. blts. & nuts & fender washers
- 8 pcs. 1 1/2"x120" thin-wall electrical conduit (plated tubing)

skin, inside panels,  
floor & grid  
leg pads  
table supports &  
clamp blocks

skin-to-inside  
panels

skin-to-skin  
corner joints

inside-to-inside  
panels  
panel joints  
windows  
joints & windows

windows

hatch stops

hatch

hatch

legs  
pads to legs

legs to shell

legs

## MISCELLANEOUS/

- 1 pc. 17'-roll soft vinyl-over-foam welting seal hatch
- 1 pc. roll 3M Tedlar tape 2"-wide #Y9057 seal joints
- 3 pcs. 1/4"x24"x24" Plexiglas windows
- 1 pc. 1/4"x6"x42" Plexiglas water shield (hatch)
- tube of clear silicone sealer seal windows
- clear resin wood sealer inside finish
- flat white exterior primer outside undercoat
- acrylic exterior enamel outside finish
- 3/4 cubic yards pea gravel site
- 4 pcs. 6"x30" screw-in earth anchors tiedown

## ALTERNATIVE

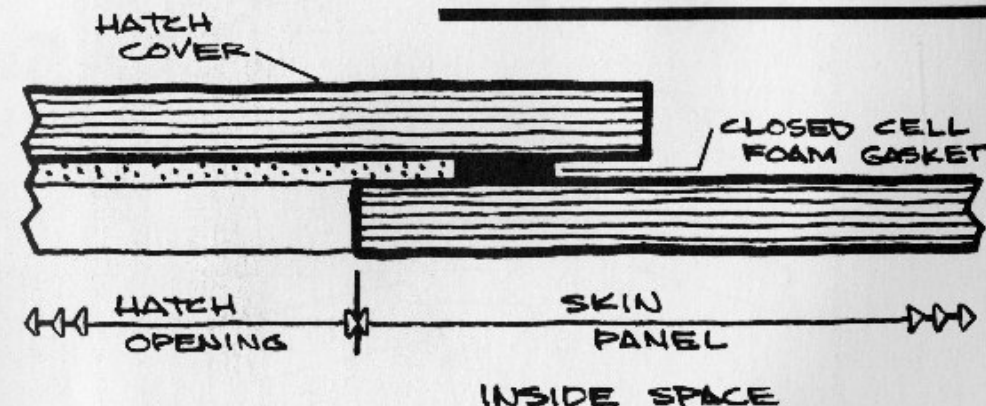

OPTIONAL VENT HATCHES/an aluminum, screened roof vent from Sears (over food area) is a good investment. in some climates you may need to add vent hatches or change some windows to vents. use same opening & cut 3/8"-plywood scraps to Plexi size, hinge like entry hatch. then put self-stick, closed cell foam strip (see above) as shown on outside of shell panel. space hinges & trunk latches off surface of shell with stacked washers (like entry hatch). get dark-green superfine nylon mesh screen (for tents) & staple it on inside surface of shell panel. i use little tree branches to prop covers open & bolt them shut.

# MATERIALS

# LEGS & FEET

LEGS/see if your local electrical supply house will cut conduit to length for you. they may not charge much but watch them like a hawk on holding dimensions. this will speed up a long process. squeeze ends flat in a heavy vise to form tabs. try always for consistency. drill joining holes with 5/16" bit, then bend tabs to proper angles relative to the long axis of conduit. pads are 16" circles of 3/4" exterior plywood. put a 1/4" hole in center for mounting bolt. it also joins conduit at that end.

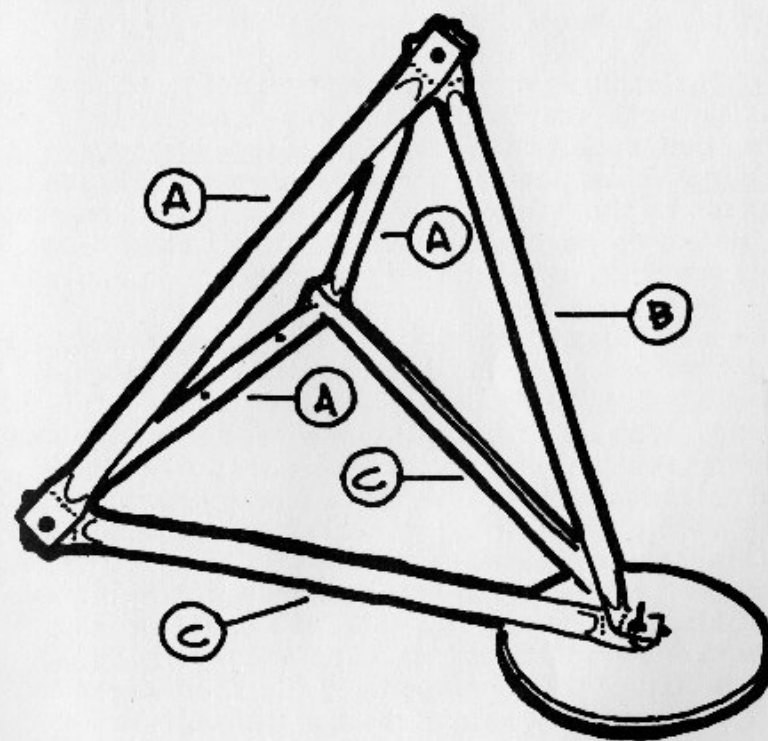
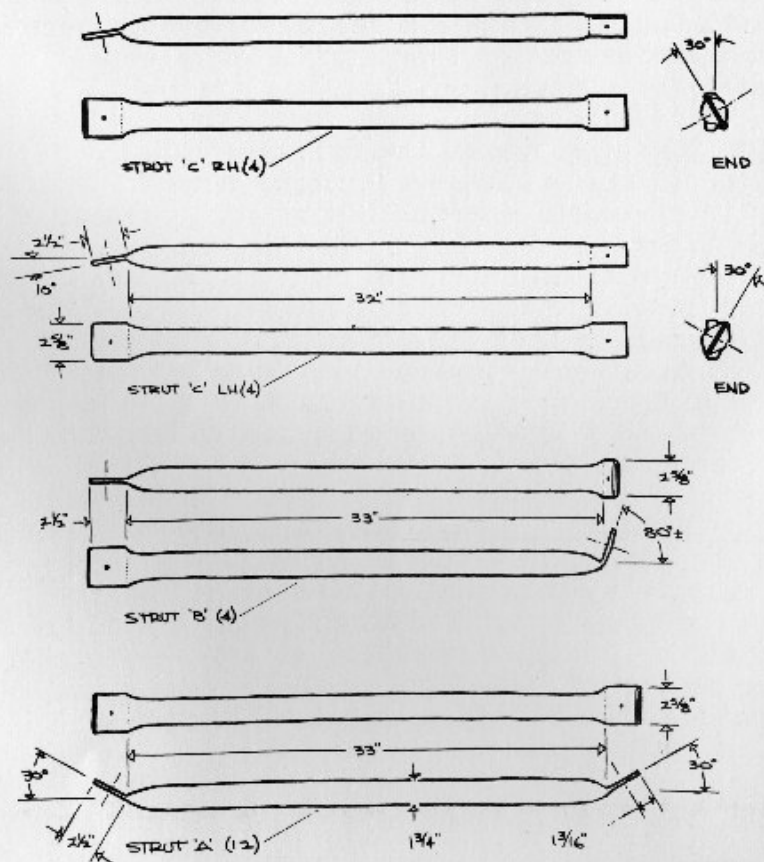

LEGS TO SHELL/do a trial assembly with 3 skin panels & 3 inside panels. set assembled leg tetrahedron on this corner. use 3 mounting holes in bottom skin as guide to mark location & direction of bolt holes in bottom leg member. drill 4 of these, one for each tetrahedron.

LEGALITIES, ZONING & THE KAFKA TRIP/anytime you put up a shelter to live in be prepared to deal with the aroused maniacs who believe that only an oversized, status-dream stage-set house with a thirty-year mortgage can be the real home of contemporary man. behind all the savings-&-loan-type solicitude for hygiene & "standards" lurks the old money-profit game of real estate, speculation & the collection of interest on long-term loans.

BE FRIENDLY/stow your paranoia (& mine), smile & stare ahead like with the lumberyard guy. most zoning codes have an open-ended category for homes not occupied year-round. this can free you from most illogical limitations. the Microhouses have another advantage in not being on permanent foundations. this temporary quality lowers the anxiety of some zoning people.

WASTE/be a straight arrow with all waste products to prevent hassles. i think the small Thetford self-contained toilets are best. if each person (or each 2 persons) uses one, emptying the 5-gallon holding tank every two to four weeks in a public facility, it works OK. we've reduced waste-water amounts drastically by bathing with an ordinary orchard pump-up spray can delivering an invigorating & effective mist. using the spray or sponge bath you can have a fine time with 1.5 gallons of water. we limit cooking pans & dishes & wipe all food out with absorbent paper before washing. these methods limit food waste in water & also cut the amount so much that in a low-density population area a shallow, gravel-filled dry "well" works fine. ordinary trash & paper waste can almost be eliminated by reusing packaging materials & altering consumption patterns.

CAUTION/the use of screw-in earth anchors is a good idea, especially if you are in a storm or wind track. use one at each corner. make four slack 1/4" cable lengths with loops (held by cable clamps). one goes around bottom leg strut & one loop in eye of the earth anchor.

HOW TO USE THE 8' MICROHOUSE/this home was designed for one person, long-term, & for two good friends, short-term. that's its reality on an atomistic level. what use is it if you're a community of eight or nine? how do you apply it to a man and woman with two kids? our old-culture conditioning provided no good answers. the best it could supply was "can four or five be hooked together?" trailing off in a murmur about "prefabrication is the thing now." insatiable simple-minded gluttony for space & materials continues after Earth gives endless messages that it is not inexhaustible.

OTHER VOICES/fortunately, another component in my information bank was anthropology. not the cold, cousin-naming academic litany but the people-loving cultural kind. in this mind-dynamiting, informational Klondike i found an answer & realized why the serene & earthy settlements of true Africa had always interested me so much.

RENAISSANCE/we discovered the "village" again. for several persons you use several Microhouses, loosely grouped in a natural setting taking full advantage of the land & climate. sun, shade, breezes, north wind & outlook determine individual positions & orientations with the whole combine surrounding a central community area. the community part can be a sheet of clear polyethylene ridged by a rope between two trees or a pipe Matrix with a table, open fire, canvas roof & deep, wooden, heated Japanese tub for bathing.

PRIVACY, COMMUNITY & ECOLOGY/multiple Microhouses nest in the landscape & become a new living experience. this is a miniature settlement of light, colorful, mobile "huts" loosely ringing a village square. one person, one shelter, with free choice to be alone or social, not forced to be either by the architecture. the Microhouses are as lightfooted as Indians on the land.

# THE VILLAGE

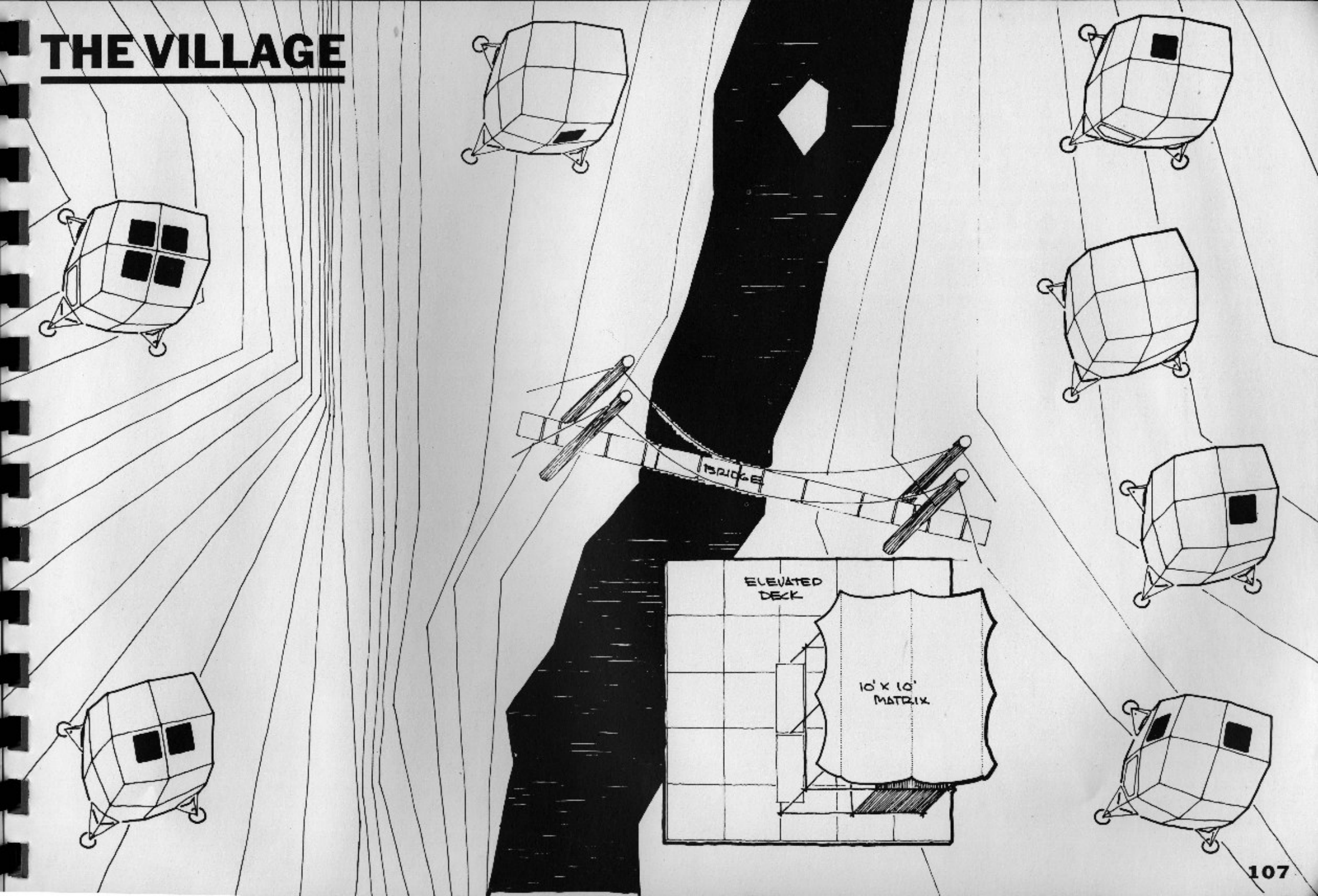

**OLD  
MICRO-  
HOUSE**

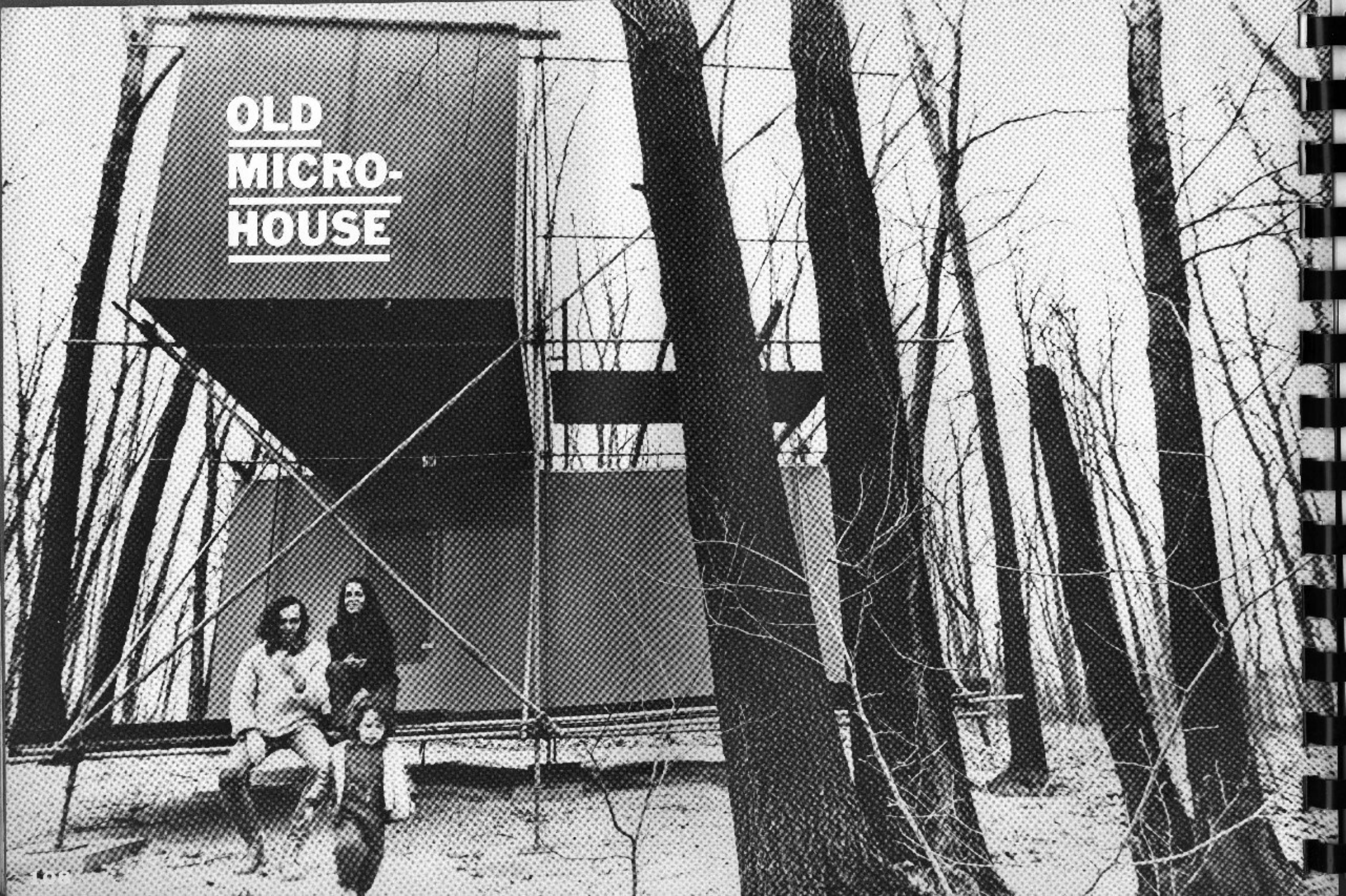

SWEET SURPRISE/early one spring morning in 1963 a guy brought me a telegram. at the time i was visiting the Illinois Institute of Technology to work with some students on my Information Structures. i'd designed early total environments using only information in the form of projections, film & audio. one of the unique things about them was their comprehensive quality. the persons in them were no longer conscious of anything but total immersion in the information; none of the usual distractions of how projection screens are supported & how the exits are handled. even the floors of the chambers & the persons in them were covered & lost in the images flowing from the projectors. continuous & simultaneous (like life analogs), these structures got a fair amount of space in the national & international media. some guys who follow that stuff even suggested it was powerful seeding for what happened in images at the Montreal World's Fair in 1967. Life magazine, still a strong media force at that time, did a heavy promo-literary effort in late 'sixty-two about the "new breed of people taking over," & they included one of my Information Structures. the joke was that the only thing i wanted or needed to "take over" was my own soul & life direction. some reconstruction was really called for after those 1950's years of fruitlessly attempting to convert the corporate barracudas of N.Y.C. to Platonic philosopher-kings. i was desperate to get out of the urban repression of numbers & go to the country where there was real liberty to build. i'd stashed a little piece of money & began to generate fantasies about holing up at Groveland & getting some work done on new prototypes. joe & mother had tipped me to the used-schoolbus market after they bought one for \$100 to store wild-cherry lumber from the sawmill on the Pekin road. they had it right behind their house & it was in real good shape, fireproof & not much rust. i figured to use one for a workshop & one for some students who wanted to come down.

THE TELEGRAM/was from the Graham Foundation for Advanced Study & announced my appointment as an architectural Fellow plus an award of \$8000 to follow the Microhouse work. for a while there it was really like a 'thirties movie where you come out of your amnesia to find you are really the natural son of a kindly Colorado silver-mine owner. that Life publication had really done the job. we managed to come down off the ceiling & get our outfit together & headed for the timber in a secondhand van full of good feelings.

TREES/joe & mother had never done much with the timber beyond smiling encouragingly on it. she walked with long, careful steps looking among the leaves for four-leaf clovers & mushrooms while joe got out there once in a while with jim the pup to dig a possum out of a brush pile. so when jim & tom came down with me, we had to start clearing. we made ten brush piles, each about the size of a 2 1/2-ton truck, to get it so you could walk through. we trimmed out a track to the west side. it was opened up.

AT LAST/we had reached the point where we could try the Matrix network, full-scale outside in the wind & rain. actually all the previous Living Structures & the 2x2 antecedent of the Fun House had been rehearsals for this moment.

LOOKING FROM THE EAST/the Microhouse that carole, josh henry & me use is a big space frame (eight cells, continuous members) with two plywood volumes in it, one over the other at right angles. the Matrix is made of 1"-pipe members 20' long & each cell is a 102" cube. this measure is from centerline of pipe to centerline of pipe. this is a very spidery network (pipe about same size as a 50¢ piece) but has proved quite stable in 70-mph winds we get now & then due to our place on the edge of the SW-to-NE storm track that slants up through Illinois. tension members are responsible for this structural integrity. these could have been cable but i used same pipe as Matrix because this is less vulnerable to kids or vandals when there's nobody there for a long time. but each site differs in exposure to natural forces, so use intelligence & talk to local people before building this thing romantically on a headland in Tierra del Fuego. i always try to build in timber, where it exists, to have advantage of its protection.

THE SITE/this Structure is the first to do without conventional foundations. instead it sets on nine concrete pads (or feet) just like an animal. between these & the Matrix are 1" threaded rods to allow adjustment & trimming of the Structure if ground changes. the free length of leg below the last horizontal set of members is critical to structural rigidity & must be held to minimum, as here. add more bracing & network for safety so free leg is not too long.

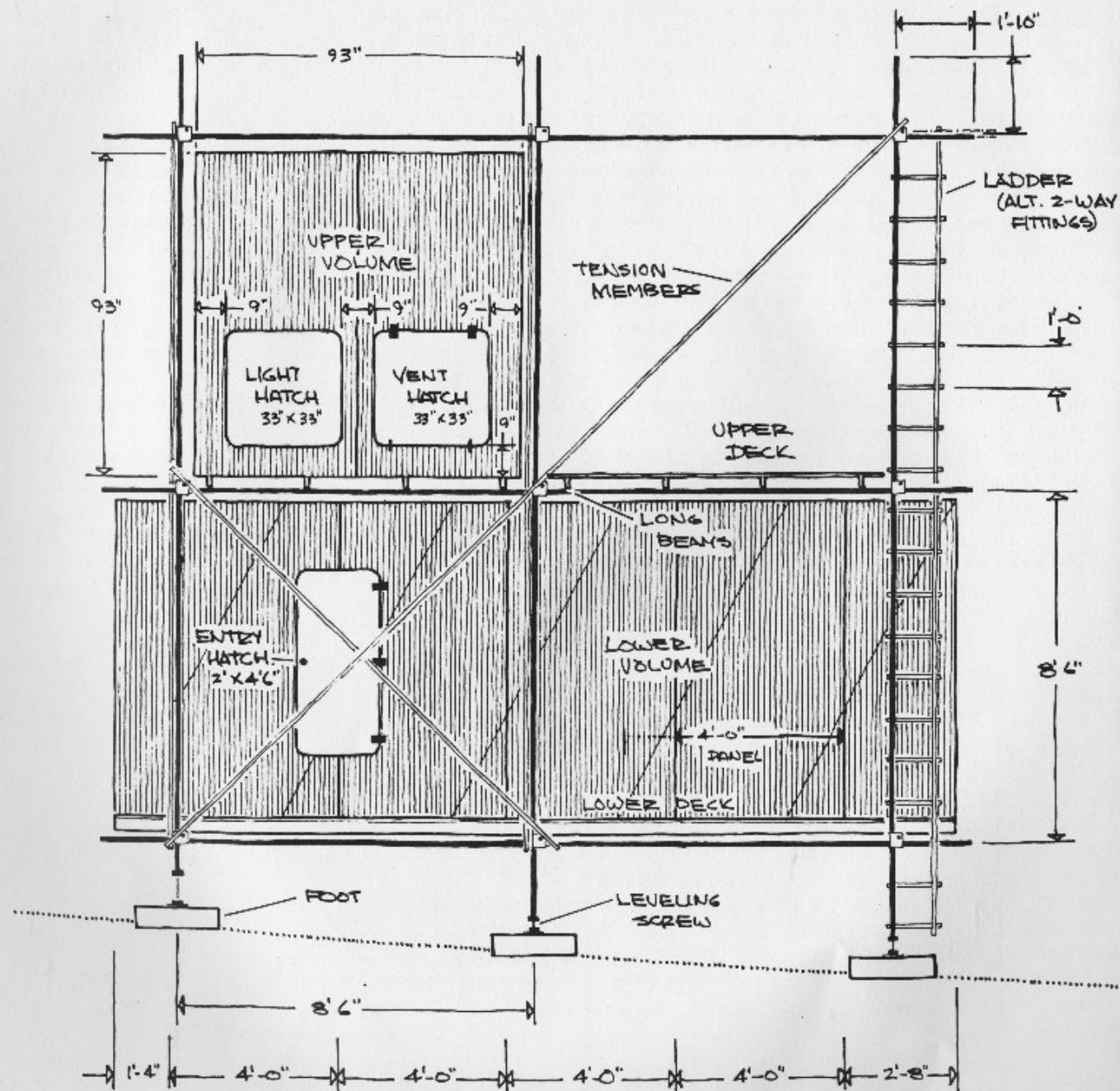

PANEL (EXT. SKIN) WIDTHS ABOVE/REVERSE PATTERN - OTHER SIDE

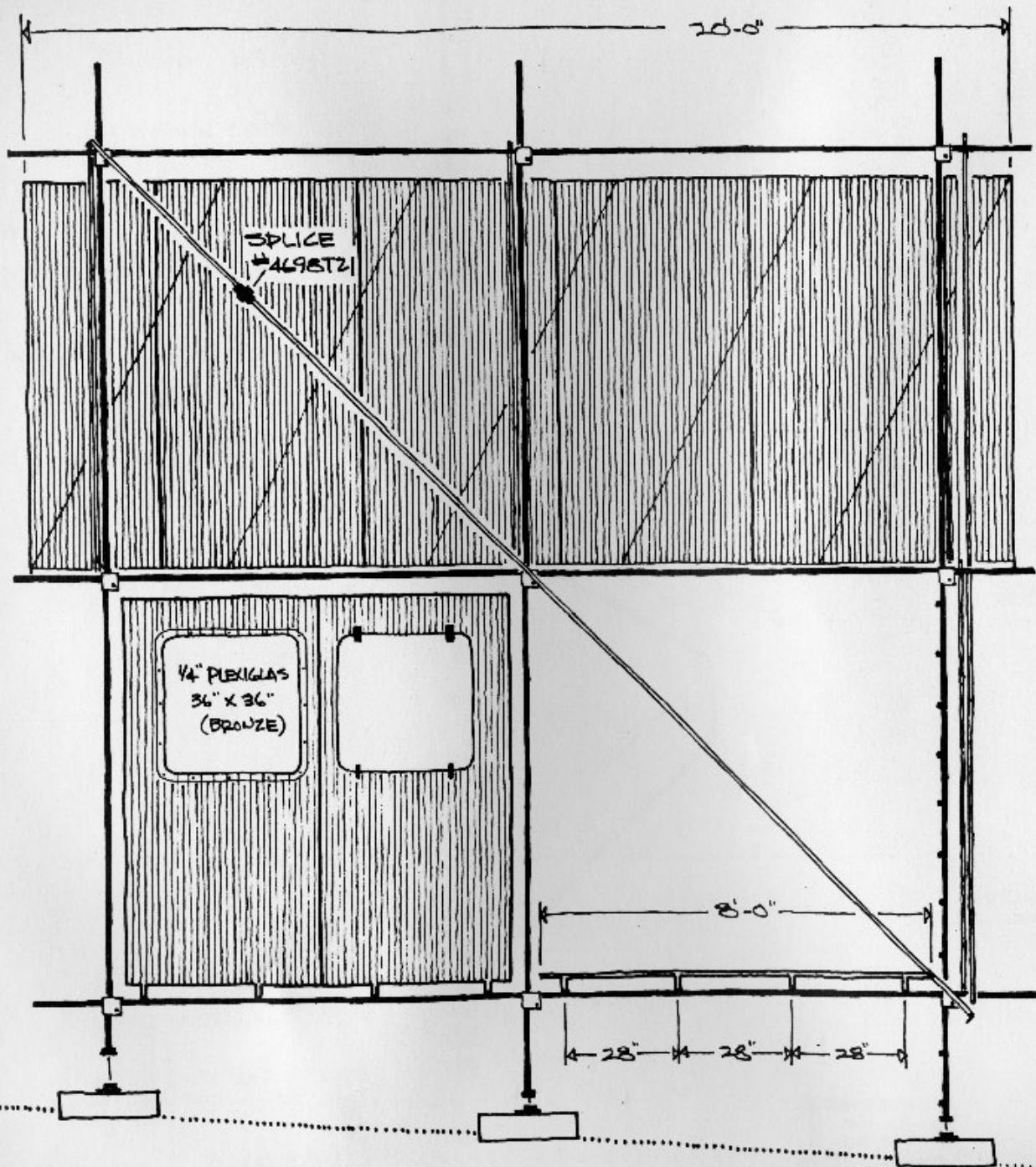

FROM THE SOUTH/this Microhouse was designed for individual privacy & extendibility. opportunity for calm, undistracted examination of the world & the self is scarce. recent traditional architectural norms, "rooms" connected by "rooms," with forced sharing of cooking, hygiene & most other spaces, force us to be social whether we feel it or not. this produces much hostility. each volume of the Microhouse is made for one person. each volume with cooking unit, washing & waste of its own. because each has his own equipment, with no designed-in imperative to share, the person is freed to get straight with himself. then, self-reliance & independence having unkinked the ego, you are OK to come together with others, because you are ready & want to, not because the building forces you to.

MANY CHOICES/this Structure is so extensible that it can be responsive to almost any human or physical situation. it can house a large family with decks & arcades connecting generations & it can waltz over uneven ground like an Indian leaving no scars just by adding to the Matrix & multiplying volumes.

SUPERCAUTION/don't let flexibility blind you to the fact that this is high-performance structure & like a Gran-Prix car requires judgment & discipline in use. don't overbuild vertically & don't overload the volumes or the decks.



PADS/the concrete pads are cast upside-down in a level form. fasten the 3/4"-plywood pieces together with large finishing nails. don't drive them all the way in. the form will come apart easily when the pad cures. wrap & staple 6-mil polyethylene around each board in the form. this makes a smooth surface on the final faces of the concrete & slows drying, which makes stronger pads. cut a 1"-pipe scrap 4 1/2" long for the cast-in bushing. slant sides of block so it can be broken out later with a chisel. the 1 1/2"x3 1/2"x3 1/2" block produces the void for the hex nut & washers holding the final assembly together. assemble temporarily in form with short scraps of 1" threaded rod (see drawing below). you'll have to experiment with proportions of the mix to get it just right. having an old concrete man like joe around won't hurt anything.

PRODUCTION/if you need 12 pads, make 4 forms & pour 3 cycles. multiple forms let you finish before you get too old to use the structure. pour form about half full, agitate with a 1/2" dowel & a controlled plunging motion. this works the mix against form walls. then drop in the 6"x6" reinforcing mesh. talk a contractor out of some 18"-square scraps. then finish pouring to top of form, use a straight 1"x4" board to rake across top of form to make level surface. don't remove from form too soon.

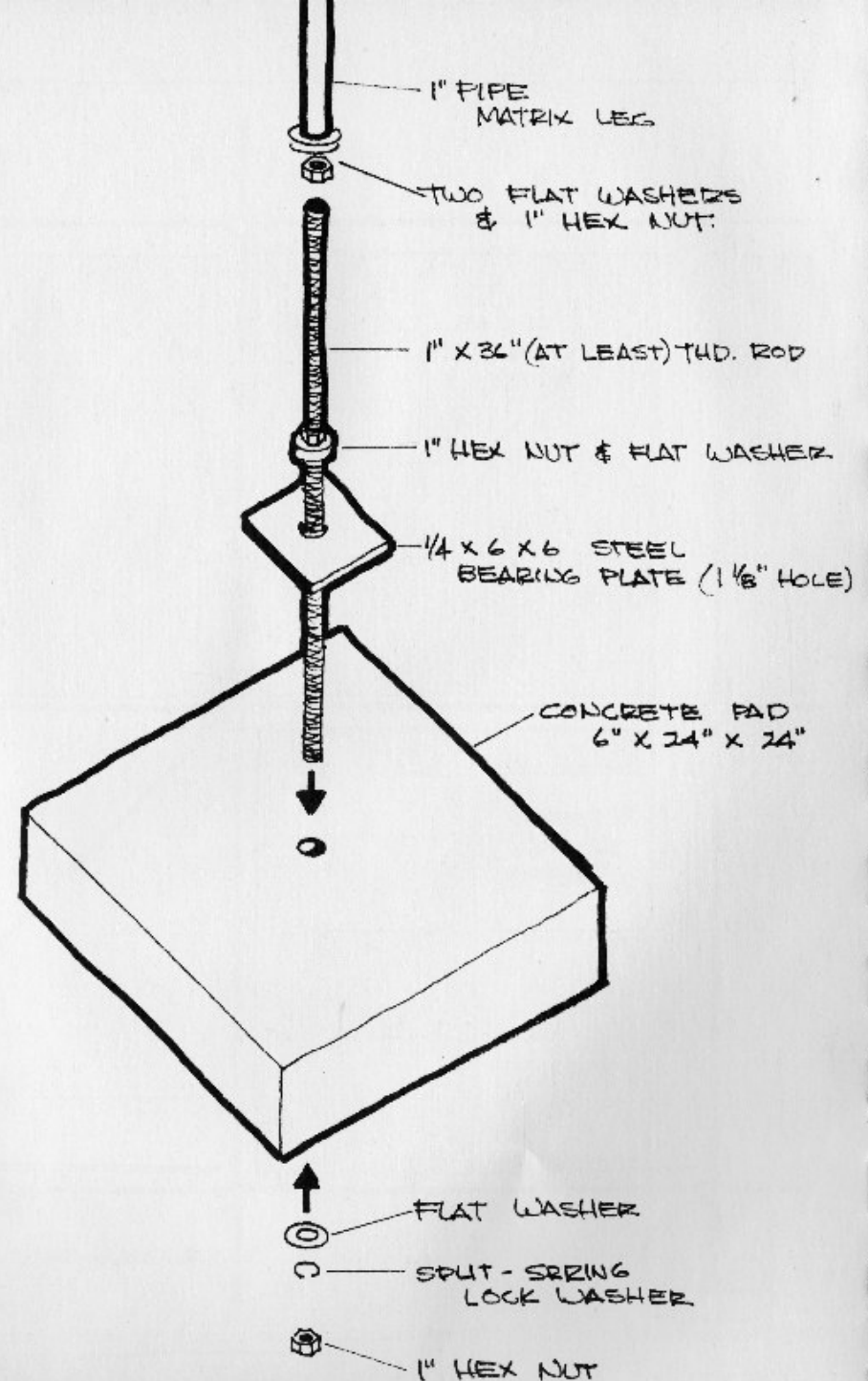
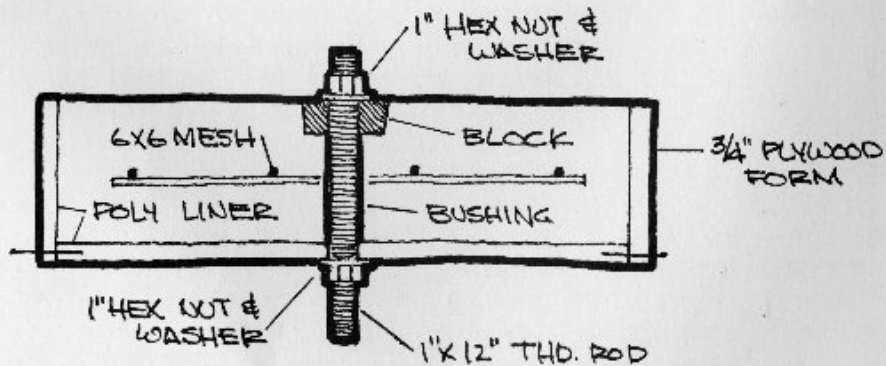

**FEET**

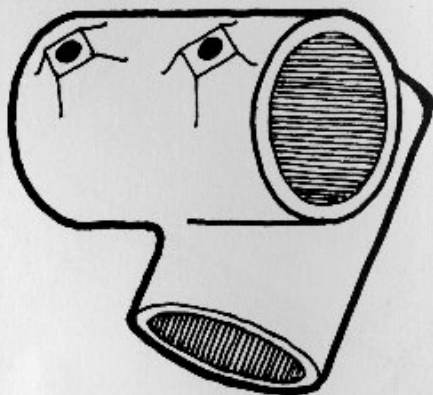
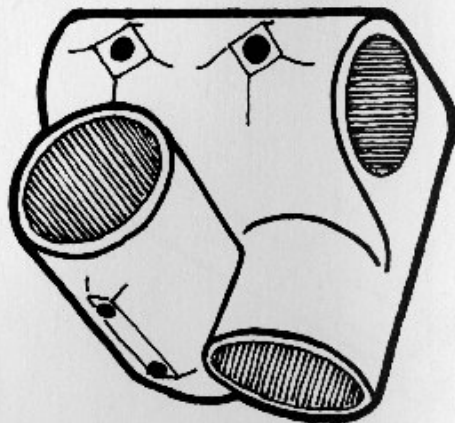

3-WAY FITTING/the original Old Microhouse uses the same fittings as the Fun House but you probably remember that the lady is no longer operational. so i recommend you use the McMaster-Carr Supply Co. fittings mentioned on p. 83 (see drawing at left). the 3-way joint works on all 27 of the 90 degree joints in the Old Microhouse & i use it where two tension pipes cross on the outboard end of horizontal members. bear in mind my previous supercaution & don't even build more than one level if you can't handle it. our disease as North Americans is we believe that when we think it, we can do it.

2-WAY FITTING/you can get a 2-pipe fitting from the McMaster-Carr Supply Co. that will work when you have one tension pipe joining to a horizontal pipe. it is a closed fitting (see drawing at left), which means it's position must be predicted beforehand (or, alternatively, it will only work later by slipping over horizontal pipe ends outboard for external tension members).

ALTERNATIVE 2-WAY FITTING/there is a solution if you forget a 2-way joint, assemble beyond it, & don't want to tear everything down & put it in. on p. 40 of McMaster-Carr catalog there is a "cross-grip pipe rack clamp," \$2.24 each. these are "open" fittings & can be integrated into the Matrix without taking it apart. very useful if horizontal tension members are needed under a deck due to steeply sloping ground.

PUT PADS DOWN/remove all loose dirt & topsoil where the pads go & scrape a really flat, level place in firm earth for them to sit on. bore a 1 1/4" hole in a 5' length of old timber (4x4 is OK) & slip it on top of the pad leveling screw with a washer & hex nut over that. borrow a light open boat trailer to use as a primitive forklift. put 4x4 across rear frame of trailer with pad swinging loose when you press down on hitch end. with this rolling lever one person can place the pads gently on the prepared surface & get proper alignment & levelness despite their 250-pound weight. high-performance stuff won't perform unless fabrication & assembly are carefully done.

ERECTING MATRIX/the standard-weight galvanized iron pipe generally comes in "random" lengths from 20'8" to 21' so we made the normal length of a member 20'6". check position of the pads by the old Babylonian method of comparing the diagonal measures; if equal, the square is square. you need two persons, a ladder, cat feet & a fine sense of balance to build the Matrix. stack three 3-way fittings on each vertical pipe, then put three of these over the threaded leveling screws (put the three lower fittings at the right level & run a horizontal pipe through them). do two verticals at right angles to the first ones, set-screw the lowest joints & run horizontal pipe at right angles to the first one. you're on the way. add temporary tension diagonals to steady it as you go. this makes it safer & more secure to work on.

NOTES ON LEVELING SCREWS/we tried to keep the legs as short as possible to ensure a more solid Matrix. for the same reason try to limit the exposed threaded rod & make sure there is plenty of threaded rod up inside the vertical pipe. if in doubt use 6' lengths of threaded rod instead of the 3' ones.

MORE CAUTION/as you've noticed, i hope, you just build a one level Matrix to begin with. then when you get on & sensitive to its character it's easily extendible.

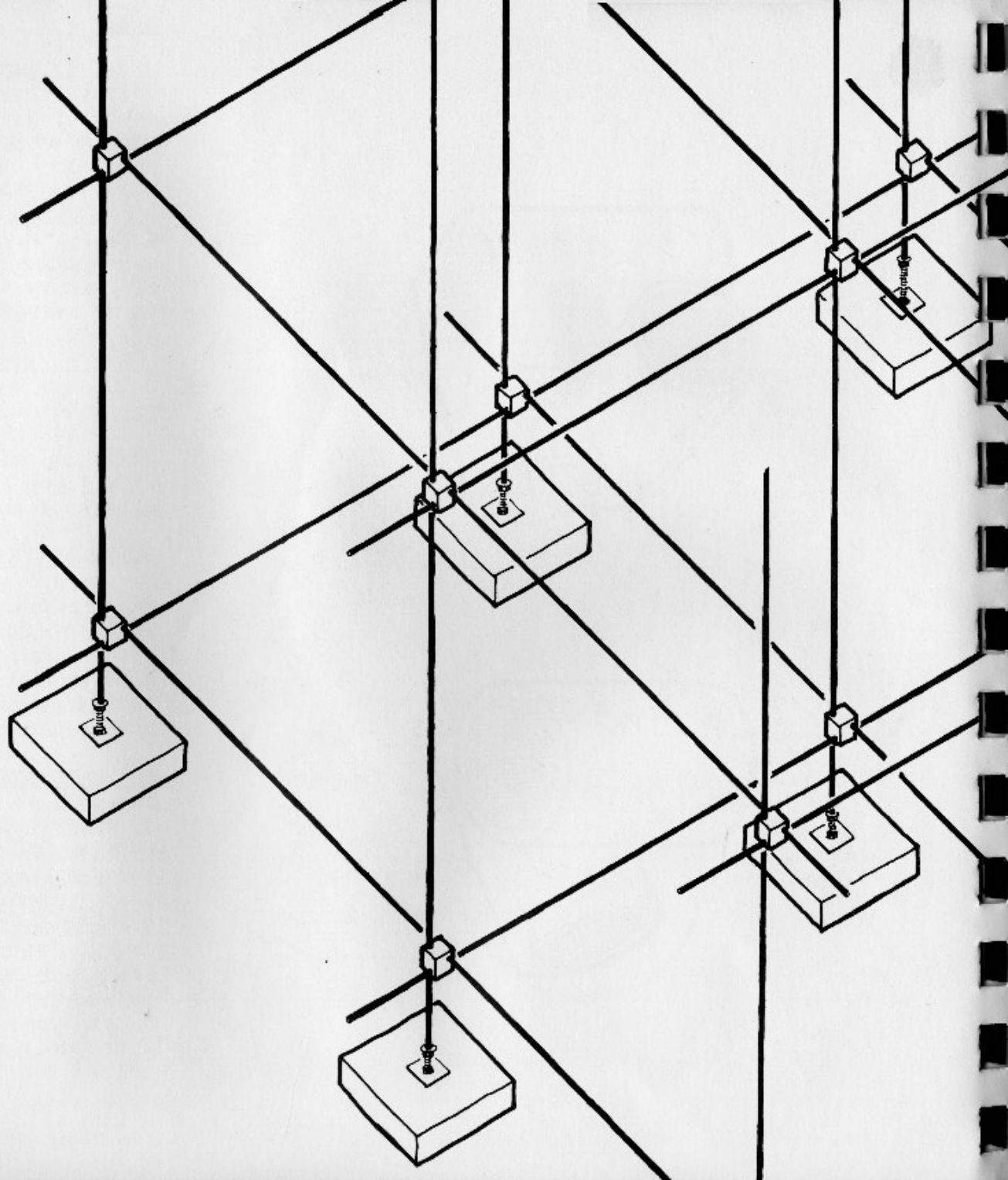

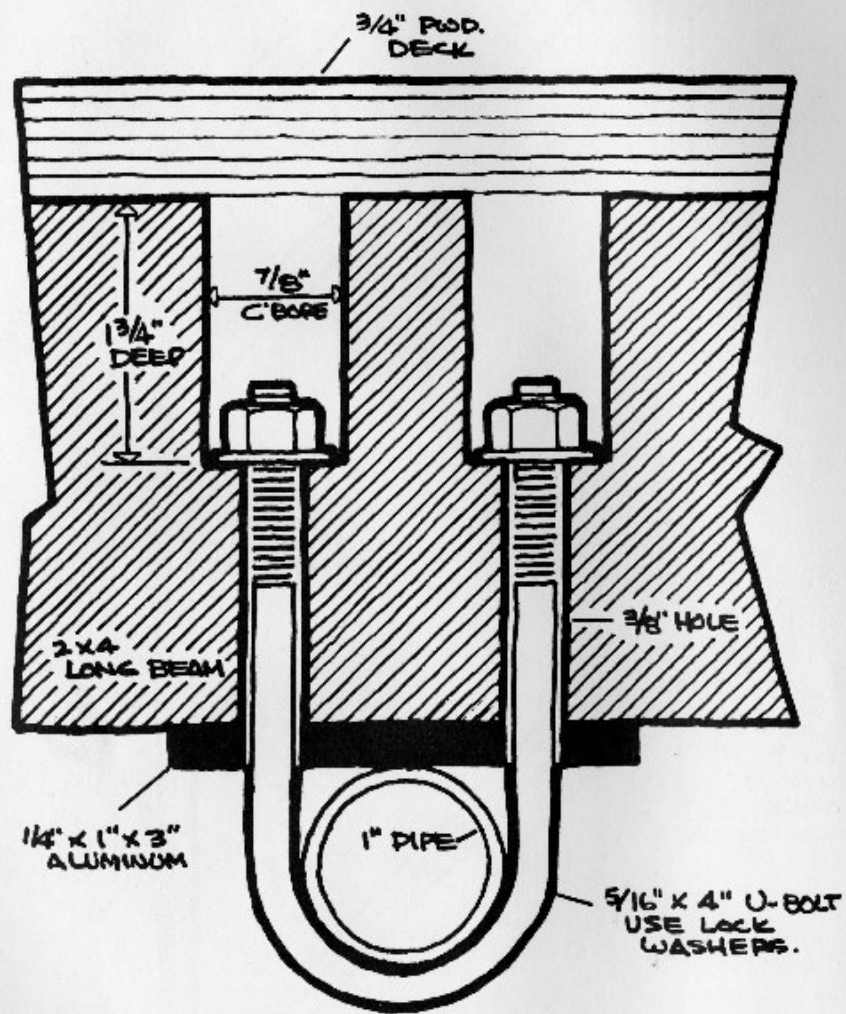

THE LONG BEAMS/when an original pipe length is not sufficient, the McMaster-Carr source has a splicer so you can add a 10' piece to a 20' one & get 30'. take plenty of time to measure the Matrix cells & trim & level it. the geometry should be 90 degrees fine all the way & measures should be within 1/16" of right on. then you are ready for the long 2x4 beams that support both the volumes & the decks. these beams are secured to each horizontal pipe they cross with U-bolts (see drawing at left) counterbored for the nuts & washers. the main thing to remember when adding components to this Matrix is that all horizontal measurements are taken from the vertical pipes because the joints are not symmetrical. so in spacing a volume, beams or deck boards, center them between the verticals on each side. if you have trouble buying good, straight 2x4's in this length, use 10-footers & splice them in the middle with two 3/4"x3"x48" plywood pieces through-bolted on either side of the joint. whichever you do, be sure to get dry, dead-straight no-warp 2x4's for this place. warp won't work.

DECKS/our original has 3/4"-exterior-plywood decks screwed to the tops of the long beams. i don't think screws are good fasteners in the same league as bolts but winter was closing in so we had to move. i hope you use bolts (see drawing left). these decks worked fine & lasted well but had a slight tendency to bow down in the middle of the crosswise span. this spoils the geometry & collects water, so you might want to follow the altered decks on chuck & lou's new Microhouse (see photo p. 126). there we are trying lighter plywood (1/2" thick) with 2x2's screwed to it. then this 4'x8' pallet is bolted to the long beams wherever a 2x2 bears on it. i think this will make a lighter, stronger deck with less deflection. the 1/2" plywood is much cheaper too.

MAKING FRAMES FOR A VOLUME/in one sense our volumes in this Microhouse are relatively conservative in construction. but it was twelve years ago, bad weather & no cover for setting up a panel fabrication area. so i decided to do traditional 2x4's but with a twist that applied some aircraft construction principles. we made the volumes like old airplane fuselages, with frames (formers) at right angles to the long axis of the volume & closely spaced along the length of it. then comes the best part—when the inner & outer skins are applied they become stressed, strengthening major parts of the structure, knitting the frames together & guaranteeing the whole thing. this was a satisfying deviation from the usual norms. it proved an exceptionally simple & direct way of framing & exhibits great strength just where conventional framing is most weak, where two planes meet.

FABRICATION/cut the 2x4's precisely to length & get them as square as you can. don't shrug off cutting the gussets (3/8" plywood from scraps of outer skin) accurately on the mistaken assumption that they don't show when the thing is completed. your liver doesn't show either but if it isn't operational you won't be young & beautiful for long. pick the flattest floor surface you can & assemble the first frame. set it together first with some little tacked-in blocks to restrain the parts while you check it, glue & nail it. check by Hammurabi's method of comparing diagonal measurements. when you have it within 1/32", mix the Resorcinol glue (smear some on end of short 2x4's where they meet the long ones for insurance) & gently tack the gussets in place. after all percussion is over, check the diagonals again & nudge them if necessary. then let this master frame set until the Resorcinol really cures. be an adult & don't rush it.

FRAME PRODUCTION/when the glue has cured on the master & its integrity is intact, elevate it on three edgewise 2x4's & C-clamp members for next frame to it using master as a guide.

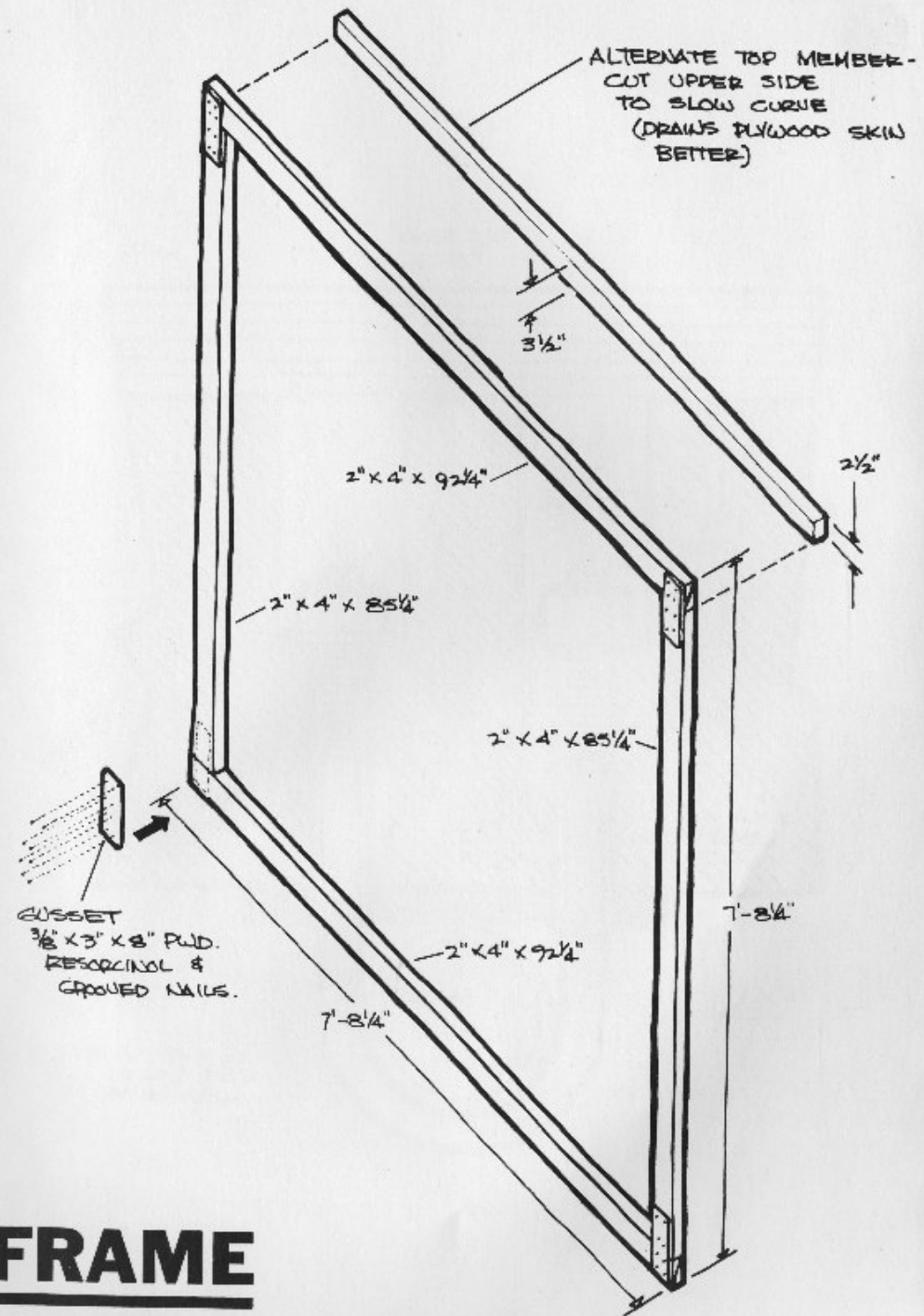

**FRAME**

CONSTRUCTING A VOLUME/first step is to put bottom outer skin down on the long beams. it's made of five pieces of plywood 3/8"x 48"x92 1/4". lay these down on the long beams, massage them carefully into correct position & tack each one with finishing nail partway into the beam. next put the frames on the plywood in the finished location. they will tend to fall over so have your friend hold two up at a time (in nearly the right place) while you tack slanting braces inside them. use scrap plywood cut from the skin for this. after you get out of danger of immediate collapse, locate the bottom of each frame precisely & tack a finishing nail partway up through the bottom skin into the frame to make it definite. then adjust each frame to perfect vertical, adjusting the bracing scraps as you go. tack up side panels next, observing the specially cut widths designed so seams of outside skin & inside don't have joints at same point. use No. 8, 1" flathead wood screws to secure to frames. place 2x2 blocks behind unsupported area (long-edge skin joints) fastening with wood screws. now guarantee security of volume to Matrix by 1/4"x4 1/2" lag screws through each frame base member into the long beam underneath.

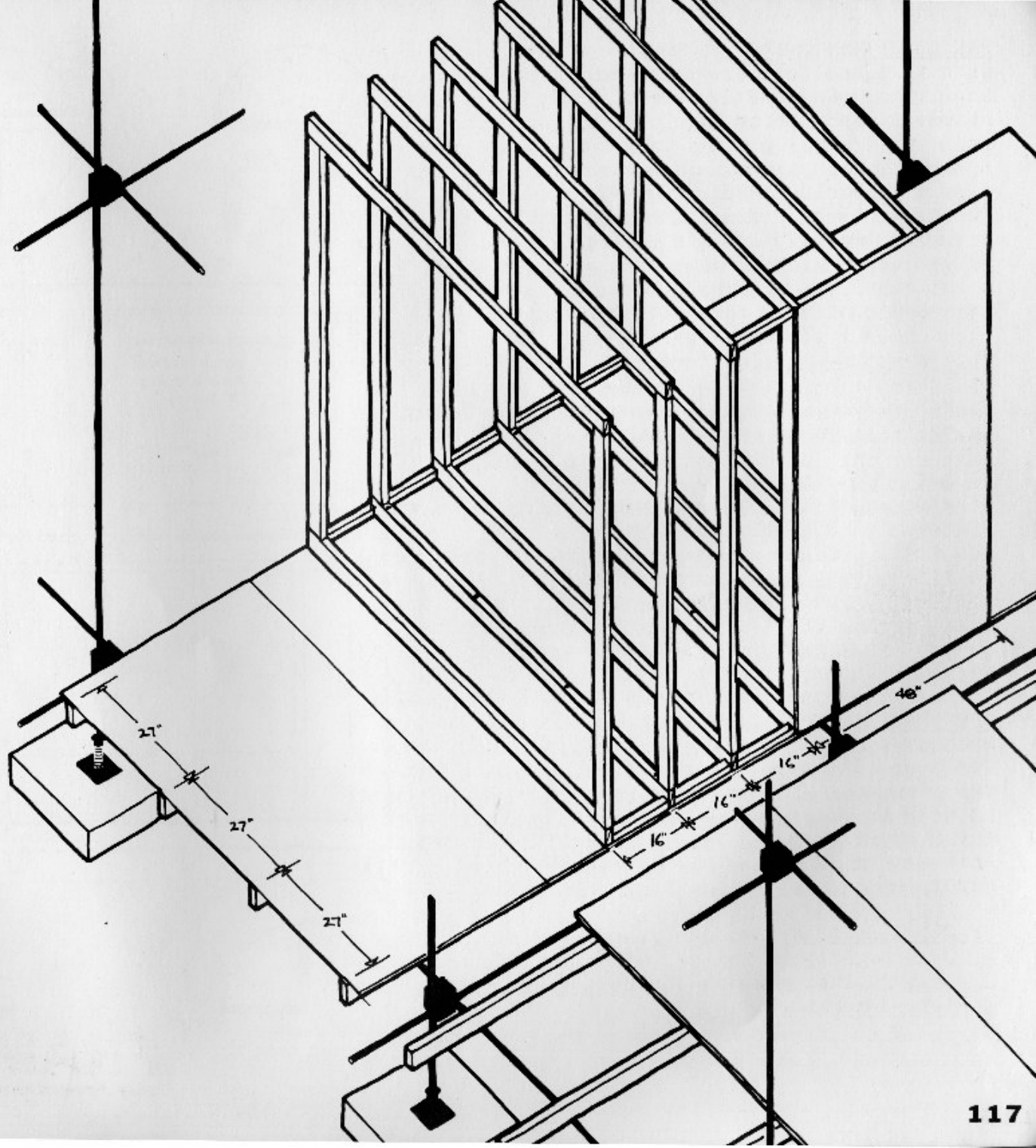

# HATCHES

INSULATION/we used 3" Fiberglas with aluminum foil (toward inside) to control condensation in wall. staple it up, taking time. be sure to wear goggles. you may laugh but i wore rubber gloves & on windy days a filtering respirator. the Fiberglas is good inert insulation but very negative in skin & lungs. we've been trying to develop a less lethal way of insulation that isn't plastic foam either.

INSIDE SKIN/lay the 3/4" floor in place starting with the center panel. tack temporarily with finishing nails. the pieces are cut 1/4" narrower than space inside frames so set with equal space on each side. screw to frames with No. 8, 1 1/2" flathead wood screws every 8". use same system for 1/4"-plywood ceiling skin & secure with No. 8, 1" flathead screws. do wall skin last. always start with panel near center of volume & work toward each end.

OPENINGS/the frame-stressed-skin method produces a rugged & simple structure but openings for light, air & passage must be carefully located & executed to preserve the integrity of the volume. we worked on many methods of putting ends on the plywood "tube" but in the end elected to do it very simply with 2x4 framing (see drawing at right). hatches were kept relatively small & isolated from the edges of the plane where they occur. this keeps skin strength intact.

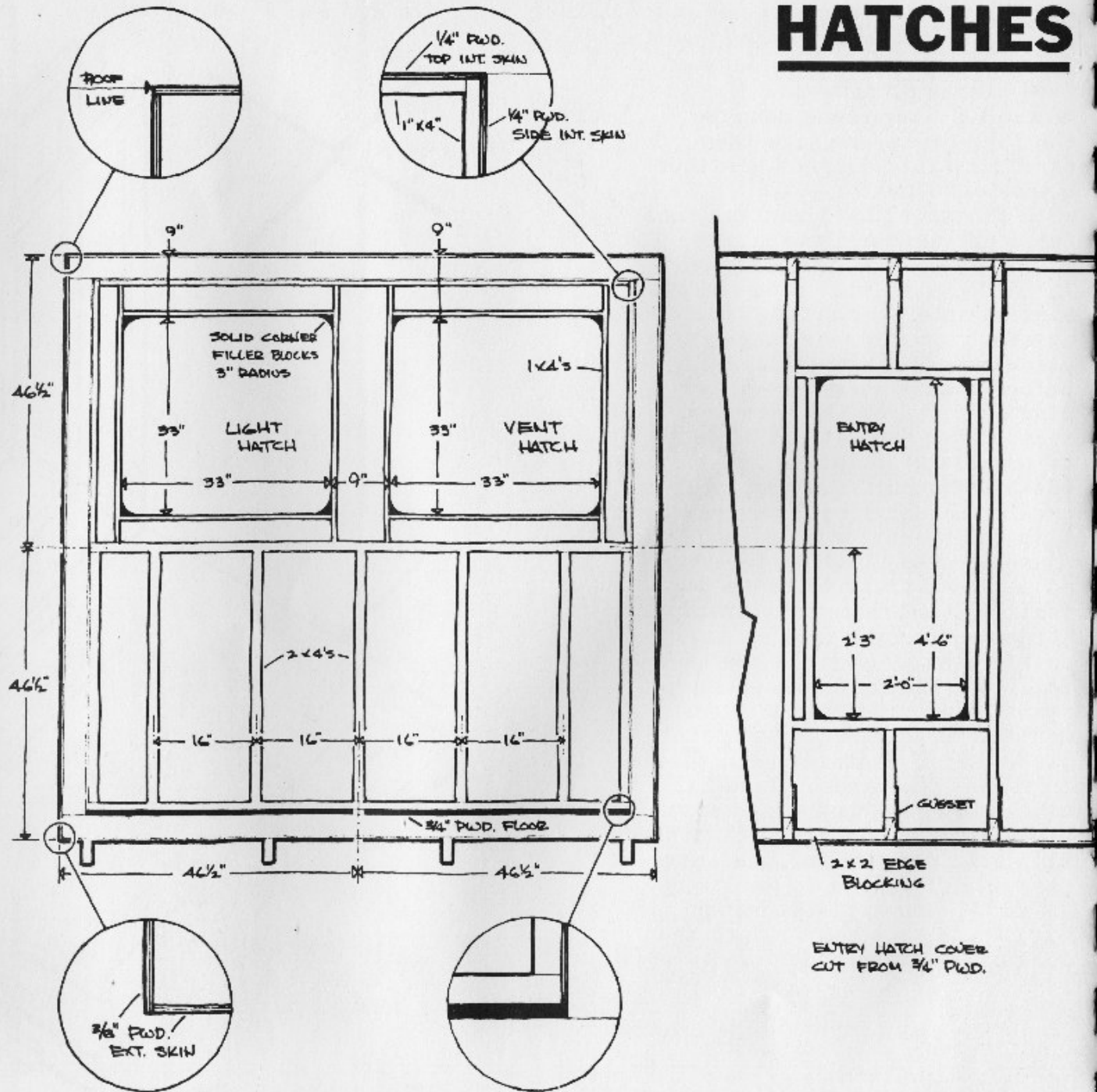





INSIDE SYSTEMS/the application of Living Structure principles & the Matrix Idea to the problem of "furniture" makes Microhouses possible. put traditional, separate pieces of furniture in a tiny shelter & you have a shack, uncleanable, crowded & impossible to live in. the old ideas of furniture have always interfered with the development of truly compact, ecologically correct homes. the Matrix Idea uses generalized planes, each of which can be responsive to changes in position & relationship (usually without tools.)

RAILS & PALLETS/we attached horizontal 2x2's to volume side-walls at 12" vertical intervals using 1/4"x2 1/2" lag bolts into the frame. then we made a bunch of pallets 16"x84 1/4" with 3/4" plywood on two 2x4's. these sit on the horizontal 2x2 rails bridging the width of the volume. by using the 16"-width module you can make a panel of a desired width for bed, table, elevated floor or storage shelf. these pallet assemblies can also be slid back & forth lengthwise for instantaneous mobility & change. the lower volume in our Old Microhouse has undergone about four pallet-arrangement transformations in twelve years of life.

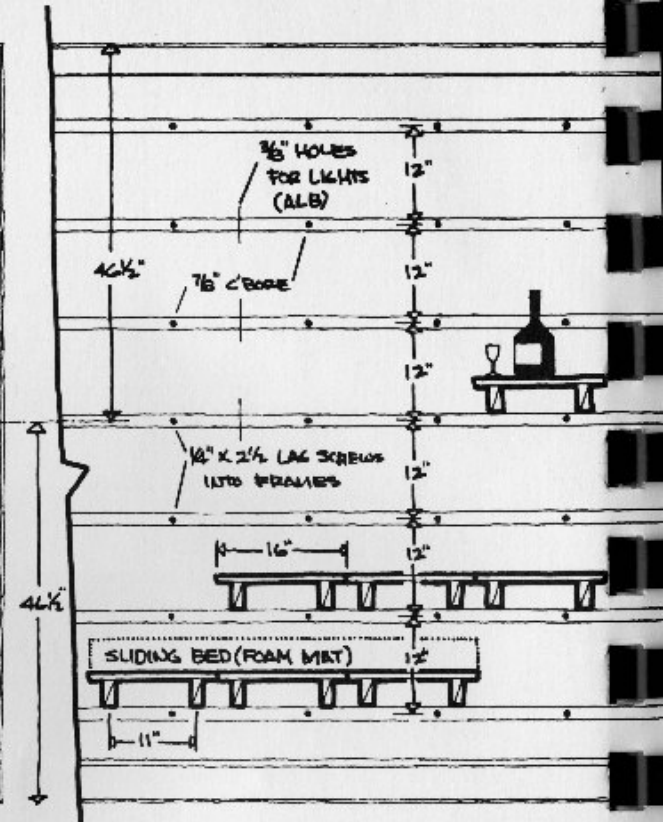
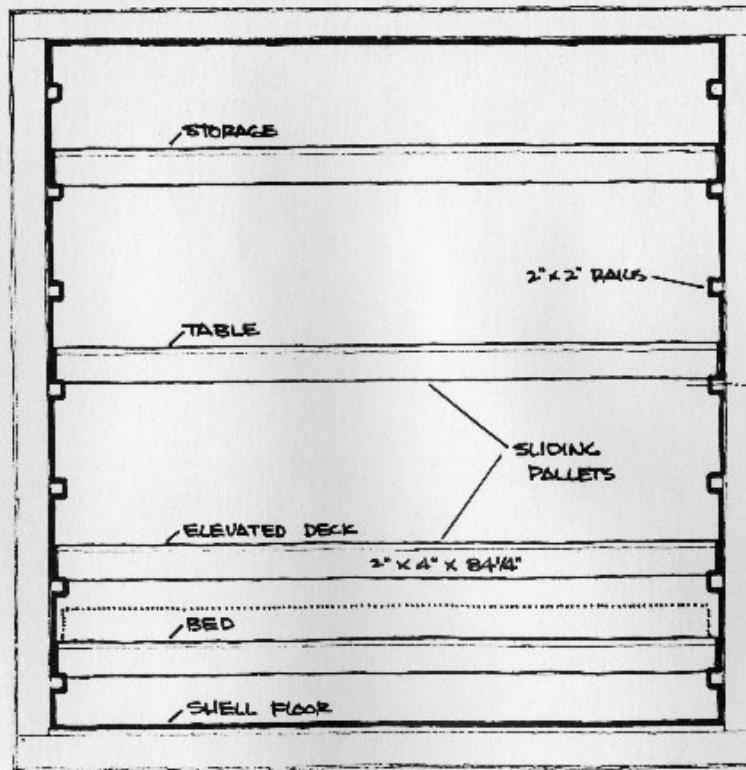

## PALLETS

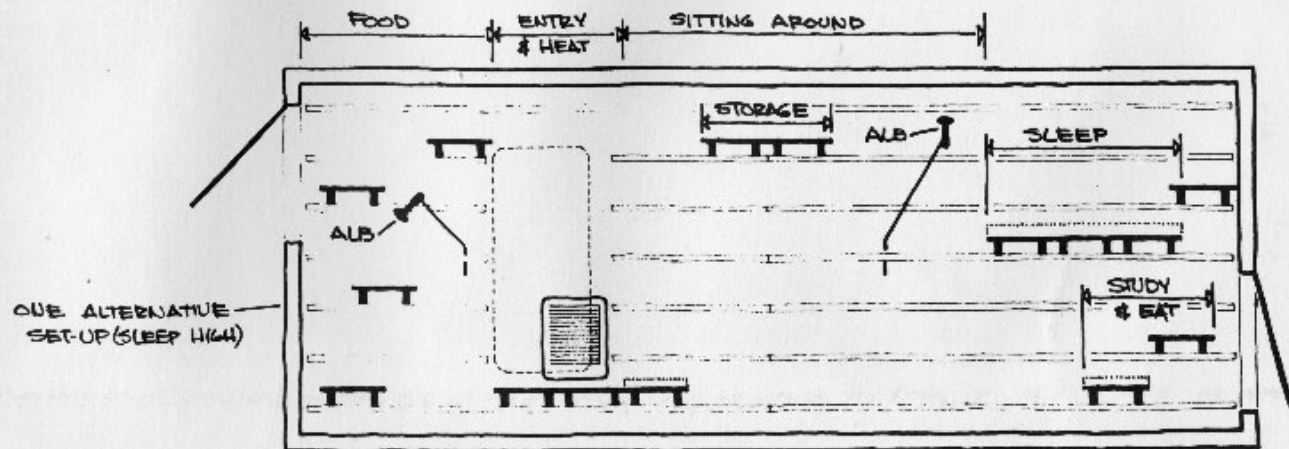



# STARTING

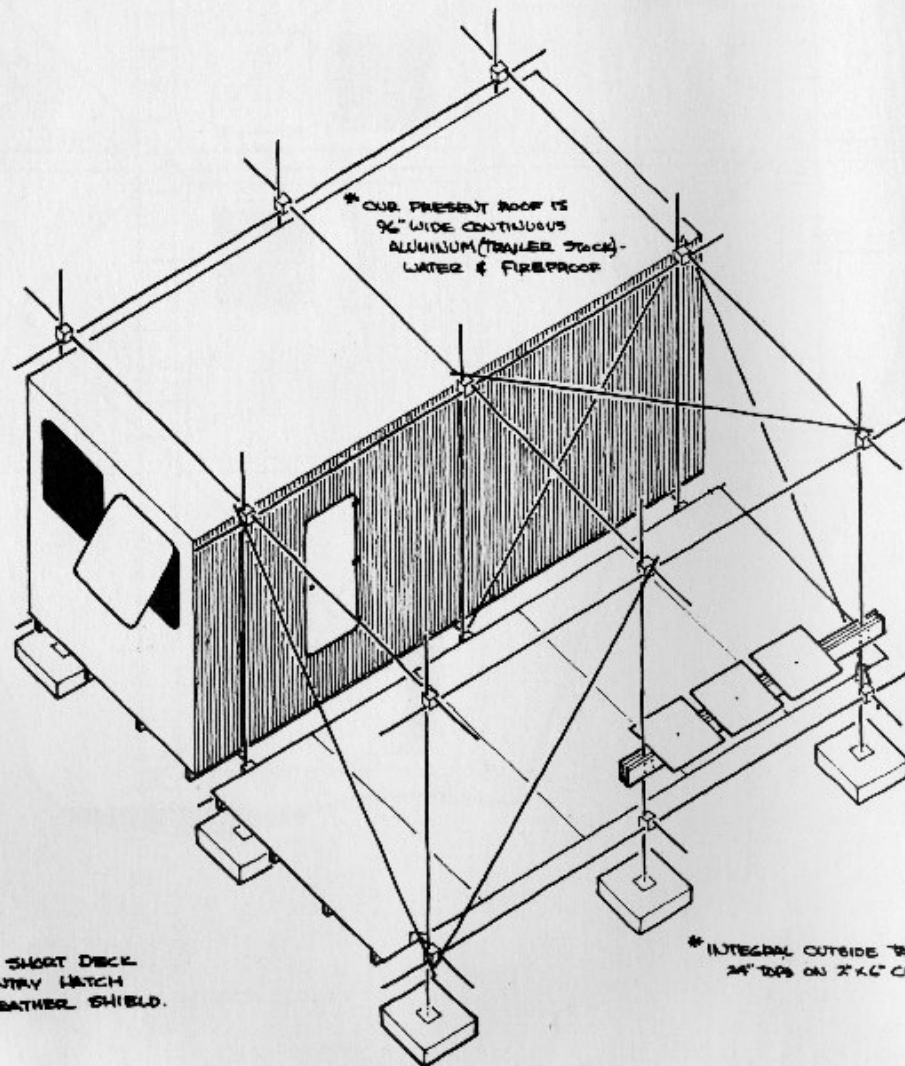

\* CONSIDER SHORT DECK  
OVER ENTRY HATCH  
FOR WEATHER SHIELD.

\* INTEGRAL OUTSIDE TABLES -  
24\"/>

FIRST STAGE/this view is the unit i suggest for starters, from point of view of cost, experimentation & the level of structural consciousness of most people i know. it's a one-volume, one-deck, four-cell, single-level Matrix. if you're an ex-English bike-frame builder & have a highly developed sense of gut structure (& a large family) just arithmetic the parts & hardware list (see pg. 124) by the number of people you have & get off. for most of us this is a good place to start & since it's so simple to extend there's no technical issue.

FOR LITTLE OLD LADIES & ME/if you are in a cold sweat just order 1 1/4" pipe & the same source has heavier fittings. use larger-diameter threaded rod & the whole thing will be scaled up & a little tougher. you still can't restore a Tiger tank on the second level but this will counteract the cold sweat.

HOMAGE TO BEN FRANKLIN/i think it's important to ground the Matrix (electrically) by attaching one leg to a 1/2"-diameter copper rod driven 8' into the ground. use a truck (long) battery cable to do this. try the junkyard.

EXPOSED POSITIONS/if you are putting this thing up on Everest or some other windy place, don't be shy about cable-tensioning Matrix corners to earth anchors.



MATERIALS/items are listed in approximate order of use in the building process. so hardware & lumber categories are integrated. wood stuff is distinguished by an asterisk (\*) preceding the quantity.

|   |                                |
|---|--------------------------------|
| 9 pcs. 6"x24"x24" concrete pads<br>(see Misc. list for components)  | feet                           |
| 9 pcs. 1/4"x6"x6" steel plate                                       | bearing plates                 |
| 9 pcs. 1"x36" threaded rod  | leveling screws                |
| 27 pcs. 1" hex nuts   | leveling screws                |
| 36 pcs. 1" flt. wash.   | leveling screws                |
| 9 pcs. 1" Split-spring lock washers                                 | feet                           |
| 18 pcs. 1" 3-way fittings #L4698Y69<br>(McMaster-Carr, see p. 83)   | Matrix                         |
| 9 pcs. 1"x10'3" galv. iron pipe                                     | verticals                      |
| 12 pcs. 1"x20'6" galv. iron pipe                                    | (level ground)                 |
| 7 pcs. 1"x12'6" galv. iron<br>pipe (splice by welding if<br>needed) | horizontal                     |
| 40 pcs. cross-grip pipe rack clamps<br>(#5046412, McMaster-Carr)    | tension mem-<br>bers           |
| *8 pcs. 2"x4"x20'   | tension mem-<br>bers to Matrix |
| 24 pcs. 3/8"x3 3/4"x1 3/8"<br>tangent U-bolts                       | & ladder                       |
| 24 pcs. 1/4"x1"x3" aluminum strip                                   | long beams                     |
| *5 pcs. 3/4"x4'x8' DFPw.  | long beams to<br>Matrix        |
| 60 pcs. 1/4"-20x4" flthd. blts. (hex nuts &<br>5/16" flt. wash.)    | plate (on U-bolt)              |
| *32 pcs. 2"x4"x92 1/4"  | deck surface                   |
| *32 pcs. 2"x4"x85 1/4"  | decks to long<br>beams         |
| *64 pcs. 3/8"x3"x8" DFPw.   | volume, frames<br>(horiz.)     |
| *24 pcs. 3/8"x4'x8'   | volume, frames<br>(vert.)      |
| 32 pcs. 1/4"-20x6" hx. hd. blts. (hex nuts &<br>5/16" flt. wash.)   | volume, frames,<br>gussets     |
|   | skin (external)                |
|   | frames to long<br>beams        |

|   |                                 |
|---|---------------------------------|
| *750 sq. ft. 3"x16" roll Fiberglas<br>insulation (foil vapor barrier) | insulate volume                 |
| *19 pcs. 1/4"x4'x8' DFPw.   | skin (interior)                 |
| *23 pcs. 2"x2"x10'  | pallet rails<br>(long)          |
| *10 pcs. 2"x2"x4'   | pallet rails<br>(short)         |
| 179 pcs. 1/4"x3" sq. hd. lag blts.<br>(screws)                        | rails to inside<br>walls        |
| *8 pcs. 3/4"x4'x8' DFPw.  | floor & 9 pal-<br>let tops      |
| *18 pcs. 2"x4"x84"  | pallet beams                    |
| 90 pcs. 1/4"-20x4" flthd. blts.<br>(hex nuts & 5/16" wash.)           | pallet tops<br>to beams         |
| *14 pcs. 2"x4"x39 7/8"  | vertical fra-<br>ming ends      |
| *4 pcs. 2"x4"x83 7/8"   | horizontal<br>framing ends      |
| *4 pcs. 3/4"x3 1/2"x41 7/8" DFPw.                                     | verticals (end<br>hatch frame)  |
| *4 pcs. 3/4"x3 1/2"x82 3/4" DFPw.                                     | horizontal<br>(end hatch frame) |
| *8 pcs. 3/4"x3 1/2"x34 1/2" DFPw.                                     | hatch frame (vert.)             |
| *8 pcs. 3/4"x3 1/2"x33" DFPw.   | hatch frame (horiz.)            |
| 7 pcs. 2" backflap hinges   | vent hatch &<br>entry           |
| 4 pcs. med.-size trunk latches &<br>fasteners                         | secure vent<br>hatches          |
| *2 pcs. 2"x4"x30 1/2"   | entry hatch (horiz.)            |
| *1 pc. 2"x4"x54"  | entry hatch (vert.)             |
| *1 pc. 3/4"x24"x54" DFPw.   | hatch cover (entry)             |

# MATERIALS

MISCELLANEOUS/

9 pcs. 6"x6" reinforcing mesh 18"-square

1 pc. 50'-roll soft iron tie wire

9 pcs. 1"x4 1/2" galv. iron pipe

pea gravel

Resorcinol waterproof glue

1 1/4"-long coated box nails  
(or annular groove nails)

10 pcs. 2"x2"x13"

staples (heavy)

key lock

2 pcs. 17'-roll soft vinyl-over-  
foam welting

many pcs. No. 8, 1 1/4" flthd. wood screws

primer & acrylic enamel

liquid neoprene

2"-wide gauze bandage

reinforce con-  
crete feet

bind reinforcing bars

bushing (cast  
in feet)

site preparation

frame adhesive

gussets to  
frame

joining blocks  
(ext. skin at  
corners)

placing insul-  
ation

entry hatch  
cover

seal vent hatches  
& entry hatch

int. & ext. skins to  
frame

finish ext. skin

waterproof roof

seal paint to neo-  
prene over seams in  
plywood

NOTE/all hardware to be zinc or cadmium plated  
against corrosion.

# IN WORK

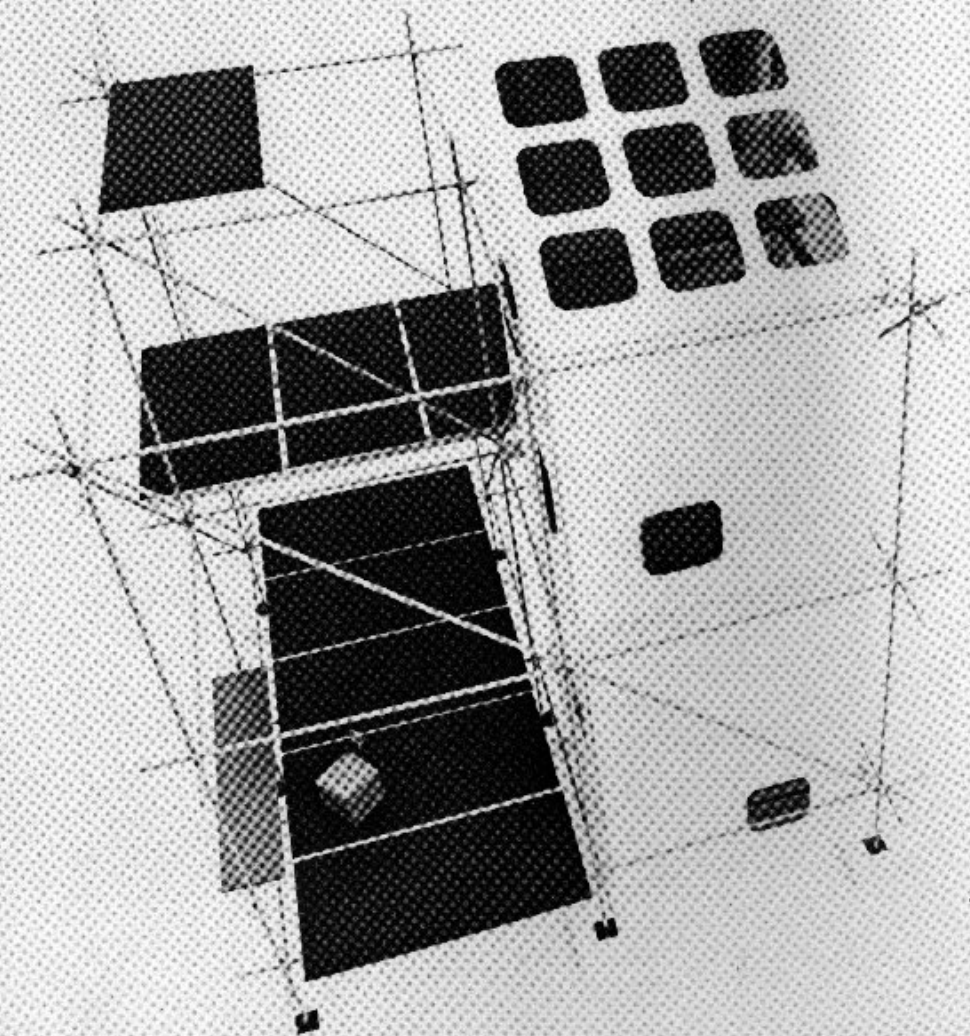

NOW/that most Westerners are far enough advanced in consciousness to at least give lip service to the idea that life is a flowing stream rather than a series of stone blocks each of which is isolated & discrete, i guess it's OK to include a few of the things we are working on now. i hesitated because i didn't want to appear to hype or whet an appetite without delivering full information but we wanted the book to be right up to the moment in what we are working on.

CHUCK & LOU'S MICROHOUSE/it was soon after we went down to Groveland that first summer that i noticed chuck & lou appearing red-eyed in the mornings & holding an occasional statesman-like conference under the elm trees. we all talked one night by torchlight & it came out that they were doing their head resources tooling to build their own Microhouse. nothing could have been more exciting than their level of involvement. their mental geography is what i've always sought in the world, a synthesis between the high-energy technology of North America & the lovely measured beat of craftsmanship from Old Europe in Czechoslovakia & Italy. you must enjoy knowing them more each day because when chuck points at a sparrow its mental health improves.

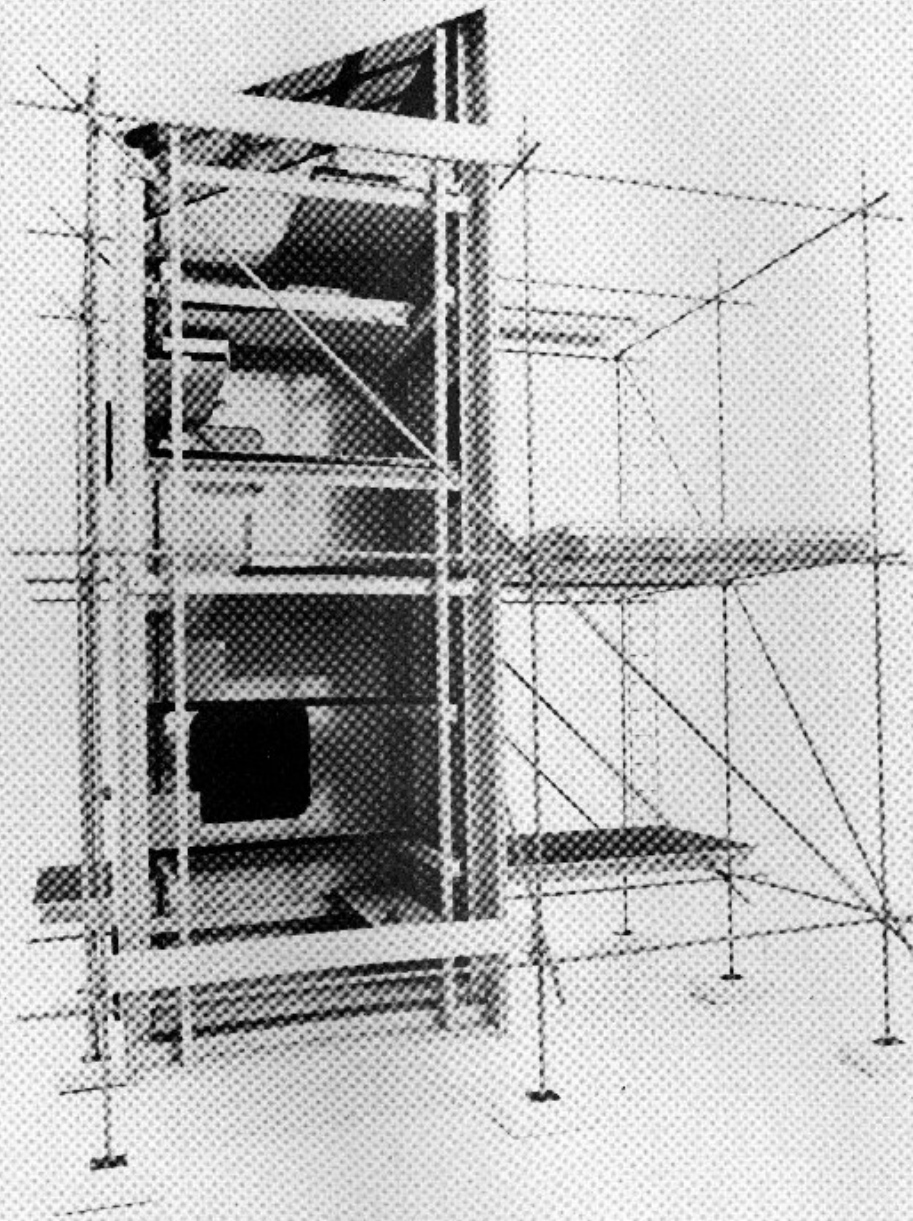

ROOTS & BRANCHES/all the things i'm involved in seem to have a way of zipping from "a long time ago" to "right now," but it seems like a wondrous quality. in my first book i had a drawing of a vertical volume in a Matrix, like the Old Microhouse one & i have drawings hinting at that vertical space with pallets for sleeping, working, talking & cooking, raining down from the top skylight like falling oak leaves.

ACTION/chuck & lou took it from there & are in the process of building a new structure which looks so beautiful from bob's pictures even though it's not yet complete. they succeeded in detailing & fabricating it splendidly. it is panelized of 1/4" plywood sandwiching some Celadyn honeycomb paper. that stuff really looks good. they used Celadyn 2" thick & it is as rigid as a Mennonite gate & precise to work with. we feel it will insulate well without the disadvantages of foam or Fiberglas. it's just Kraft paper & seems like a sound use of resources. the Celadyn guys gave a little price break, as did Borden adhesives, & my old favorite for corporate sensitivity, 3M company, came through with free Tedlar tape for sealing the joints! thank God, some corporate persons don't overdo the act about figures being so much more important than people or ideas.



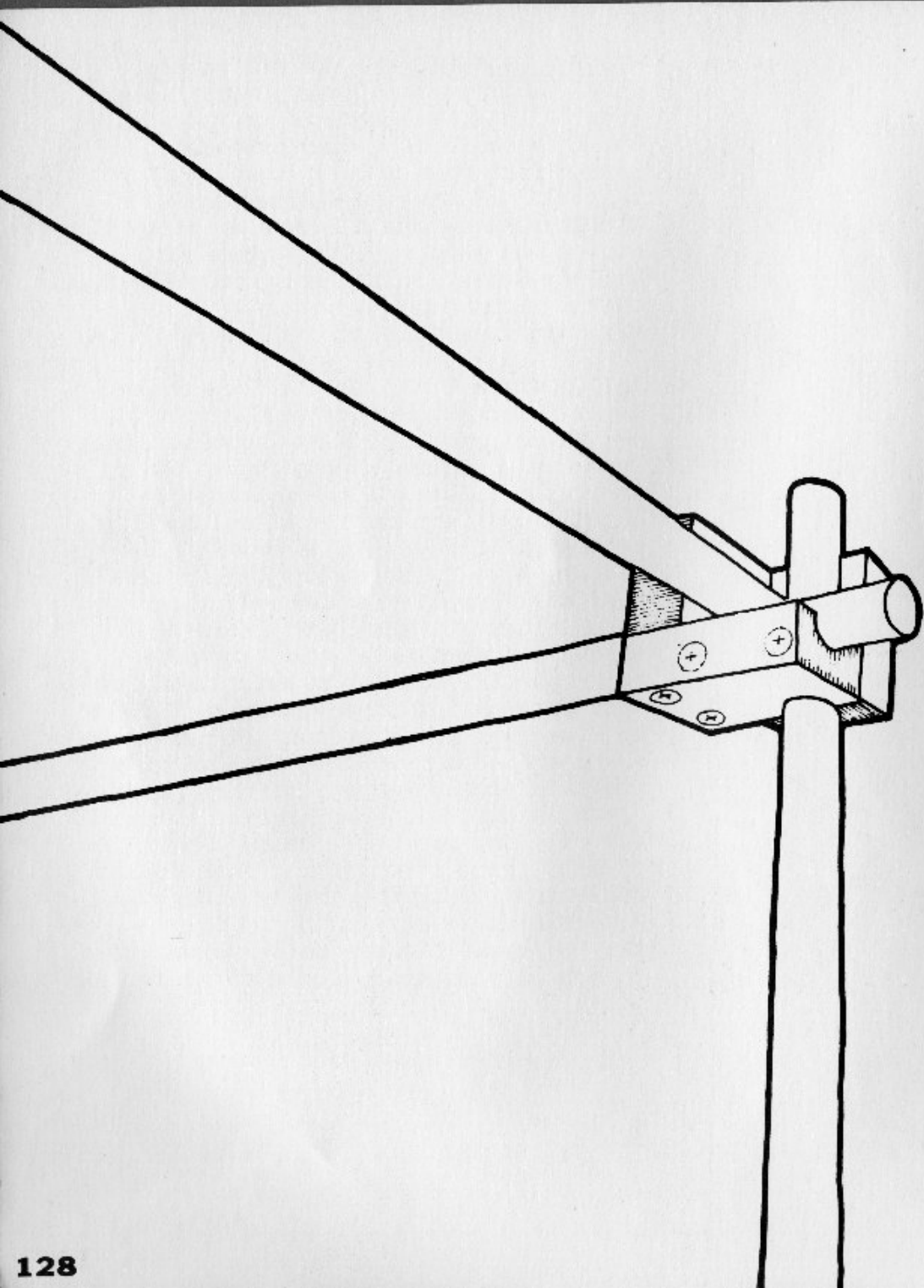

NEW JOINT FITTINGS/we are trying to get into a position where we are liberated from the necessity of buying joints for Matrix networks. i guess if the lady in Ohio had gone on we'd have continued with those fittings forever, but since she didn't that made a natural change node. the ones from McMaster-Carr mentioned on page 83 seem fine but it would be great to produce our own.

WOOD & PLYWOOD/rich has done a lot of work in ordinary dimension lumber & laminated plywood with some exciting results. his prototypes promise complete independence from commercial fabricators & look so fine he & carole will probably take patent protection on some of the work. these joints are designed for principally linear cutting on a table saw in long pieces. then the bits are sliced up, drilled for 1/4"-20 bolts & they're ready to go.

CONCEPT/the wood joints are based on assembling one universal piece into trios with the bolts. these trios then become 3-way joints. it's a real beauty.

## CONNECTORS

NEW JOINT-NEW MATRIX/this is a drawing for a new Matrix using rich's wood fittings. these make it possible for us to use electrical conduit for the tube members. it is light, inexpensive & durable because it's well plated. the joints are cheap & can be made of scrap wood that's thrown away under ordinary circumstances. they come completely apart for absolute closest-packing in shipment & can be made in right- or left-hand versions just by changing the assembly pattern. this Matrix was designed to fit into a new 9' Microhouse that will be well insulated by the plywood-sandwiched Celadyn honeycomb paper. it supports interior plywood pallets for sleeping, table & floor planes. if we have good luck & the world holds together, we'll soon have six of these test Microhouses erected in the shadow of Sears Tower & the Chicago Loop. they are to be used by University of Illinois students as on-campus homes.

GEOMETRY/these fittings, like many of the Matrix Idea objects, have a neat, witty, Chinese-puzzle kind of aspect. simple & almost obvious once you see them, but requiring much application, discipline & tenacity to develop & realize.

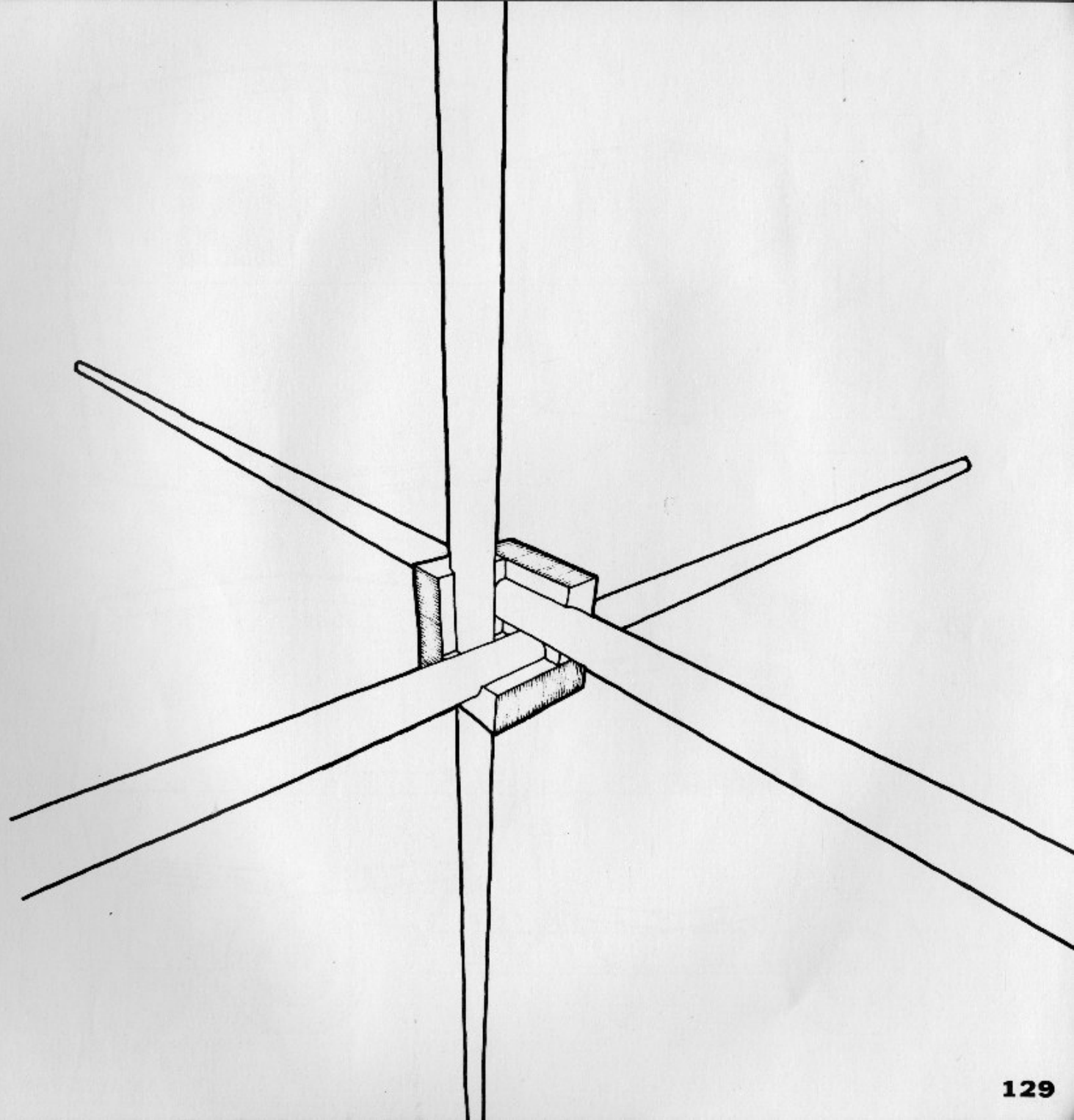

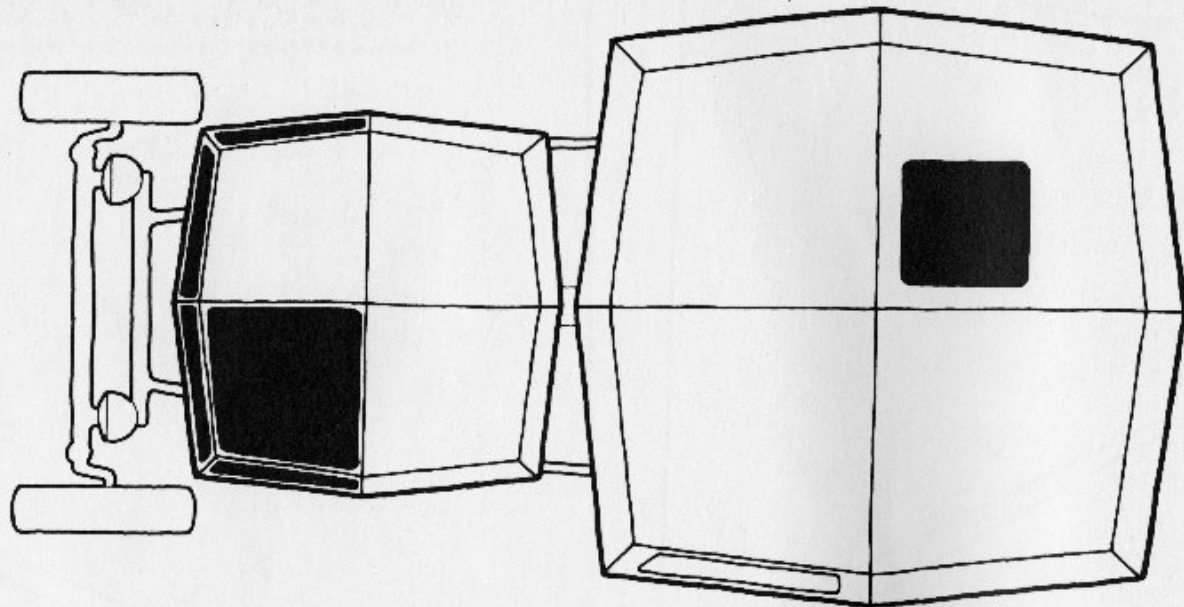

VEHICLES/as much hope as we all have for deep changes in public transport systems & an end to the environmental burden of the automobile, small-scale vehicles can be useful now if consciously designed & they may be applicable to future dreamy situations. casual transport & back-country matter-through-space don't warrant large-scale systems in many cases.

TRUTH/what i just said up there is one component of my truth. i guess the other is that i never got over sitting between uncle paul & joe, barely able to see the nighttime tunnel of moths making love to the headlights over the dashboard, in the front seat of a new 1937 Ford just in from Detroit. my uncle showed up one evening at the farmhouse & wanted joe & me to try out his car. we picked the impossibly narrow ribbons of two-lane concrete that worked fine in the days before the auto became our inviolate sacred cow. joe gently urged paul to "blow the rust out of it" & paul would snicker & pin the speedometer & we roared through the night to the next place where whiskey was available. no danger to a kid, though, because they knew every inch of those roads the way a farmer knows his field, drunk or sober, day or night.

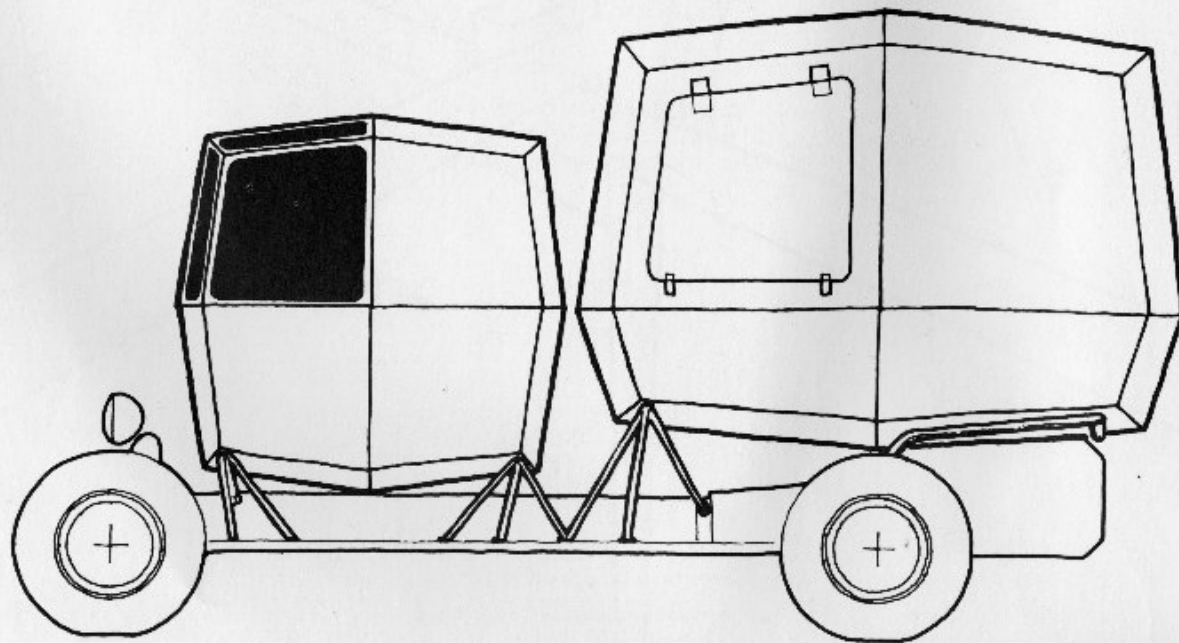

# PRIME MOVER

ROMANCE ENDS/despite that heavy nostalgia it's clear that we must become selective, especially in this area of technology. so i've worked on a series of prototypes in different settings over the years for inexpensive transport & prime-mover design. these have mostly proceeded from the point of recycling a VW bug (running gears, floor pan, engine & drive train) & designing superstructure solutions which an independent person can make with simple tools in his home. VW components of late middle age are at the present time simple & repairable & despite inflated prices due to the dune-buggy market are still not out of sight.

1974/the drawings here are of the newest prototype that I'm working on with University of Illinois students. we've obviously applied Microhouse shell geometry in designing both the cab & the container in back. i think the container can either hold objects or function as a camper which can be removed from the vehicle, elevated on tetrahedrons, freeing the rest of the vehicle for transport functions. all panels are small so they could be made in an apartment either with plywood faces over 1" honeycomb paper or maybe aluminum faces with 1/4"-plywood core. if we can keep going with it, we'll try adapting electrical propulsion & i'd like to see how it would work with shafts drawn by a single horse.

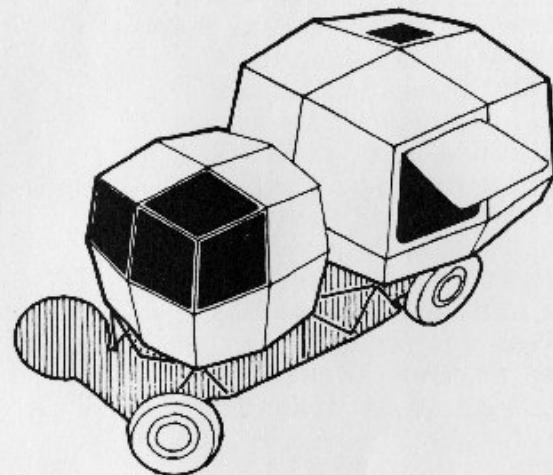
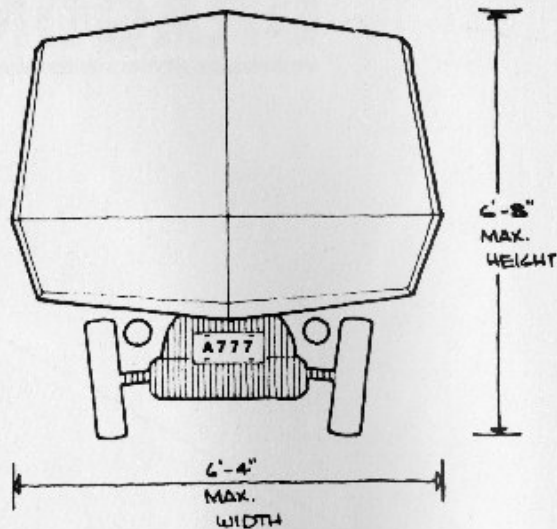

\* BEST PART IS WAY TWO SHELLS ARE HELD TO VW CHASSIS BY TETRAHEDRAL STRUTS. MAYBE WE CAN NOW STOP TRYING TO MAKE EVERYTHING LOOK LIKE IT WAS CARVED FROM A SINGLE PIECE OF BLUE CHEESE JUST TO CATER TO A 19TH CENTURY 'VISUAL ESTHETIC'.

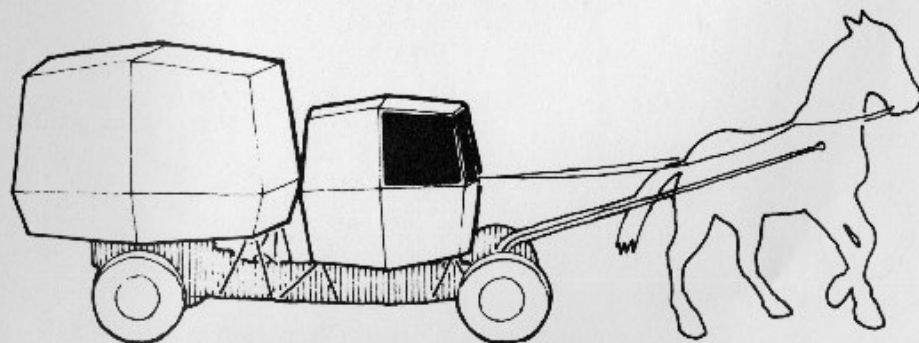

MARK TWAIN/when i was about twelve years old i had this great idea to build a kind of incredible shrinking tugboat, pilothouse toward the stern, a paddle-wheel thing, & take it down the Mackinaw to the Illinois River & maybe even to New Orleans. i planned to mount a chopped bicycle frame in the pilothouse part with the sprocket chain going to the stern paddle wheel. of course, the shortened handlebars were to be linked to twin rudders. the trouble was that i swam like a greased sash weight & got an earache when anybody looked cross-eyed at me so it didn't ever come off.

NEW HOPE/last year i was talking with some guys & we got started on a Matrix Raft to float down the Mississippi on. they made a prototype which wasn't bad but lacked the structural venturesomeness i looked for. so i designed the Dragonfly.

# DRAGONFLY

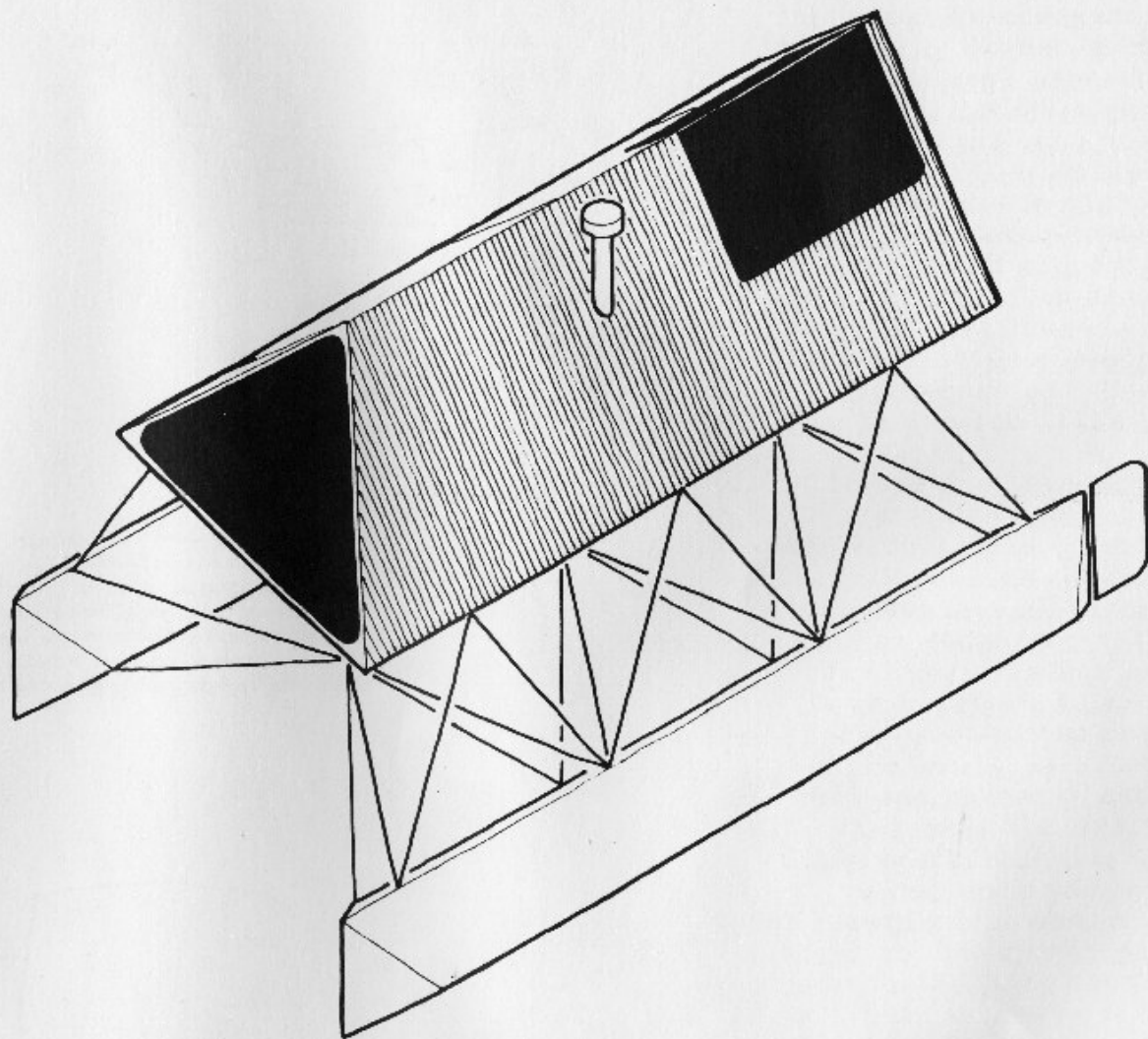

DESIGN/the Matrix Raft these other guys worked on had real simplicity & the fabrication & parts were really good. it was demountable & did a lot of things. the superstructure even utilized 48"-Cube Modules with skeletons of 2x2 stock, but it didn't seem to have that kind of confident structural integrity that a vehicle should have. so i worked on rough drawings based on rotating the square cross section-45 degrees from the way it's usually thought of. this was based on an early design for a Microhouse. this gives the foam floats a kind of self-keeling action in the water. the superstructure is to be of light foam panels clad in plywood & distributed like a large Panel Matrix. the two floats & the volume will be linked by struts of tabbed electric conduit forming ganged tetrahedrons. i think it will be strong.

DOUBTS/don't know yet about auxiliary power, maybe an electric "aqua-bug" rig would do it. right now there are a lot of maybes about the whole project & i may just be setting myself up for a very novel & artistic drowning scene but if i live i think i'll try it.

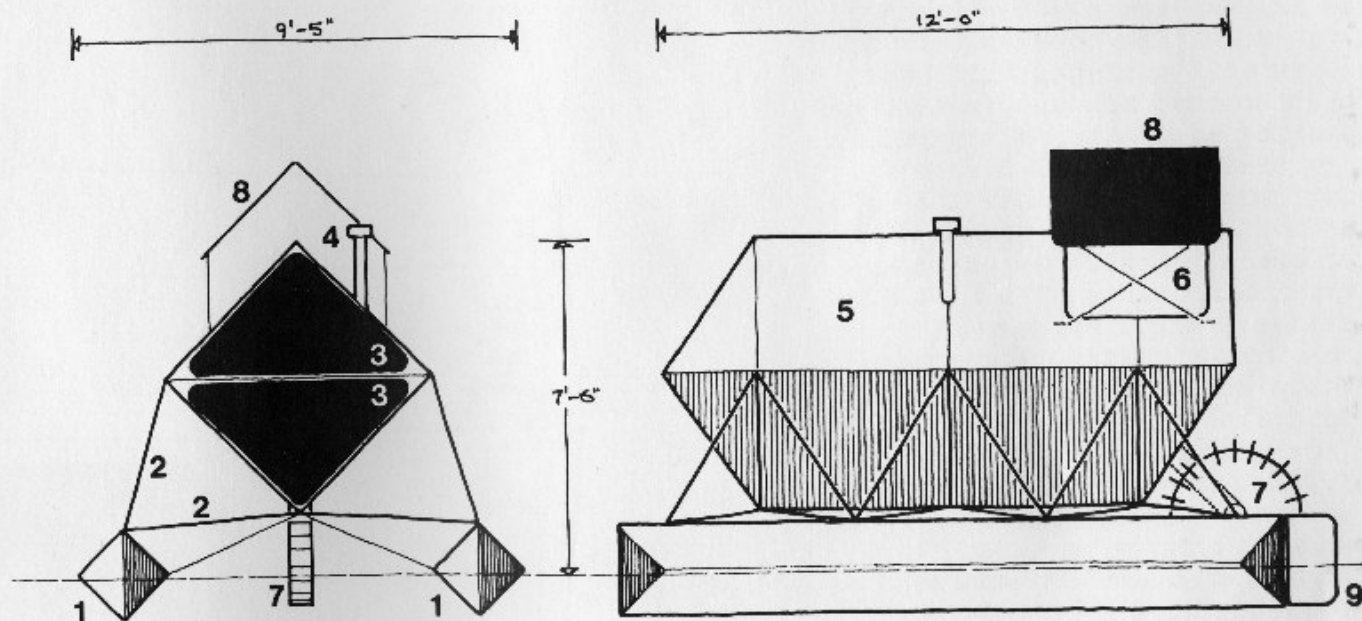

- 1 FLOATS
- 2 STRUTS
- 3 LIGHT HATCH
- 4 STOVE VENT
- 5 SHELL (EAT, SLEEP, READ)
- 6 COCKPIT
- 7 PADDLE WHEEL (PEDAL DRIVE)
- 8 CANOPY (OPEN)
- 9 RUDDER (2)

CAREFUL EXPANSION/we've had so much fun & confirmation from all the 8' Microhouses going up that about a year ago we started to work on a more comprehensive version with an interior Matrix supporting several floor levels plus all the equipment. the shell is very exciting because each of the six main surfaces will be broken up into sixteen smaller panels. the major shell dimensions will be approximately 17'6" & each individual panel can still be cut from a 48"-square blank. it will have greatly increased volume but the components will form a relatively small package. i think this high-frequency panel-breakup will yield a very strong shell.

I USED/the heading "careful expansion" up above because when i built the first model of this Microhouse in 1957 it seemed sort of big to me. i wondered if i had been bitten on the neck by the bigger-is-better vampire as i slept one night. it doesn't really seem so because the structure isn't all that big & would make a fine transition dwelling for a couple with a tiny baby. besides, it would be so exciting to wake up inside that crazy shell & Matrix every morning that i can't resist it.

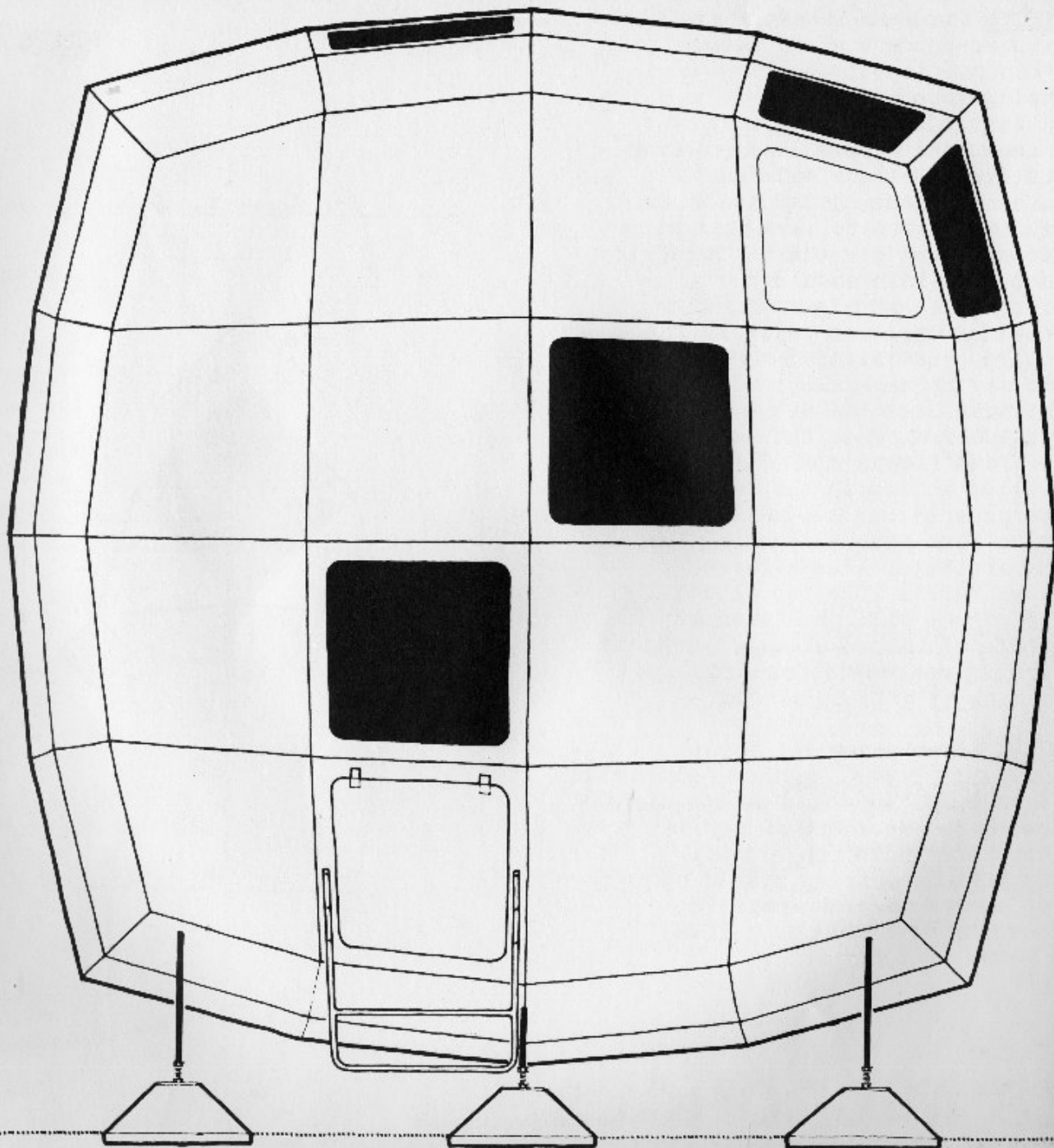

INSIDE is an eight-cell Matrix with sleeping & study levels in the upper range. cooking & hygiene are back-to-back in a package hung from two vertical members near the entrance hatch. the sunken wooden bathtub is under the lower deck panels & may have a counterweighted floor section over it. there's a 12' couch in the general area & parts of the structure have 14' ceilings. not bad for a little home which alarms the claustrophobes when verbally described but will be (i bet \$5) experientially as big as the Taj, when completed.

- 1 STUDY CABINET
- 2 16" PANEL MATRIX SEAT
- 3 WORK DECK
- 4 SKYLIGHT
- 5 SLEEPING DECK
- 6 VENT HATCH
- 7 LIGHT HATCH
- 8 BOOK RACK
- 9 COOKING CABINET
- 10 ELIMINATION CHAMBER (THETFORD UNIT)
- 11 CENTRAL TABLE
- 12 CLAMP BEAMS
- 13 LOUNGE COUCH (VISITORS SLEEP)
- 14 MAIN DECK
- 15 SUNKEN BATH (WOOD)
- 16 LADDER

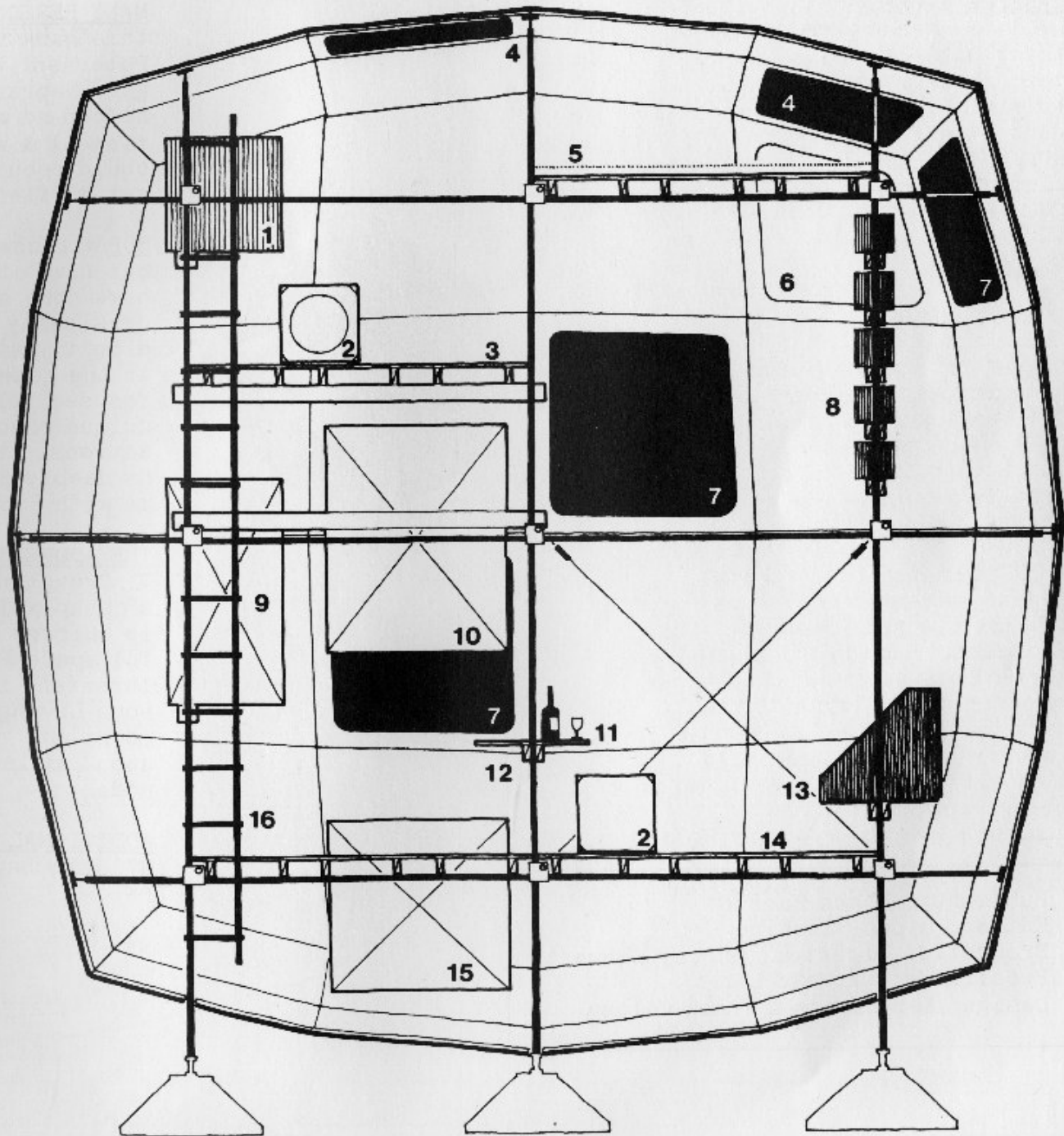

## 18' MICROHOUSE



MANY PERSONS/have nurtured the Matrix Idea but this book is particularly dedicated to Susan Petersen, who really made it possible with her good Nebraska spirit; to Jim Hart, because he helped so much to open Groveland up for settlement & work; and to CHUCK KILLAR & LOU CAIRO who could rebuild a watch in a hailstorm & never get ruffled.



BOB/witanowski made the cover photograph & all but five of the interior pictures. i wish he could have done every one of them but it just wasn't physically possible. the good part was that he didn't just point the expensive magic devil box in the general direction of Groveland but focused all his considerable human power & unique concentration on becoming one with those actions. it's hard to beat that when it's all as deeply integrated with craftsmanship as it is with Bob.

THE ADDRESS/for Groveland is Post Office Box 7, Groveland, Illinois 61535. we just rented a cheap old storefront at 7017 North Glenwood in Chicago (zip is 60626) because it's a beautiful space & should be enjoyed by someone. we threaten, in our imitation of adults, to sell some Living Structure & Microhouse precut kits (complete with hardware) there one of these days soon. at least it will be a good information node.

ADDITIONAL PICTURES/p. 24, gene hong; pp. 82, 84, 87, & 89 barbara isaacs.

Publisher: Bruce Harris  
Editor: Linda Sunshine  
Production Director: Murray Schwartz  
Proofreader: Arnold Leo  
Design: Ken Isaacs & Frank Colosa

