

[transcript]

**THIS**

EDITED BY KOLLEKTIV ORANGOTANGO+

**IS NOT**

A GLOBAL COLLECTION OF COUNTER-CARTOGRAPHIES

**AN ATLAS**



**THIS  
IS NOT  
AN ATLAS**

## Impressum

First published in 2018 by transcript Verlag, Bielefeld

© kollektiv orangotango+ (ed.): Severin Halder, Karl Heyer, Boris Michel,  
Silke Greth, Nico Baumgarten, Philip Boos, Janina Dobrusskin,  
Paul Schweizer, Laurenz Virchow, Christoph Lambio;  
chapters by respective authors

Design by Nico Baumgarten

Proofread by Philip Boos & Johanna Ellsworth

Production managed by Die Produktion, Düsseldorf

First edition of 3.000 copies

Print-ISBN 978-3-8376-4519-4

PDF-ISBN 978-3-8394-4519-8

[notanatlas.org](http://notanatlas.org)



Except where otherwise noted, this work is licensed under the Creative Commons Attribution 4.0 (BY) license, which means that the text may be remixed, transformed and built upon and be copied and redistributed in any medium or format even commercially, provided credit is given to the author. For details go to [creativecommons.org/licenses/by/4.0/](http://creativecommons.org/licenses/by/4.0/). Creative Commons license terms for re-use may not apply to any content (such as graphs, figures, photos, excerpts, etc.) not original to the Open Access publication and further permission may be required from the rights holder. The obligation to research and clear permission lies solely with the party re-using the material.

**Bibliographic information published by the Deutsche Nationalbibliothek**  
The Deutsche Nationalbibliothek lists this publication  
in the Deutsche Nationalbibliografie;  
detailed bibliographic data are available in the Internet at  
<http://dnb.d-nb.de>

Supported by ASA FF e.V. and transforMap.

Sponsored by the Rosa-Luxemburg-Stiftung with funds of the Federal Ministry for Economic Cooperation and Development of the Federal Republic of Germany. This publication or parts of it can be used by others for free as long as they provide a proper reference to the original publication.

The content of the publication is the sole responsibility of kollektiv orangotango+ and does not necessarily reflect a position of the Rosa-Luxemburg-Stiftung.

# THIS IS NOT AN ATLAS

A GLOBAL COLLECTION  
OF COUNTER-CARTOGRAPHIES

EDITED BY KOLLEKTIV ORANGOTANGO+

MADE POSSIBLE BY ROSA-LUXEMBURG-STIFTUNG

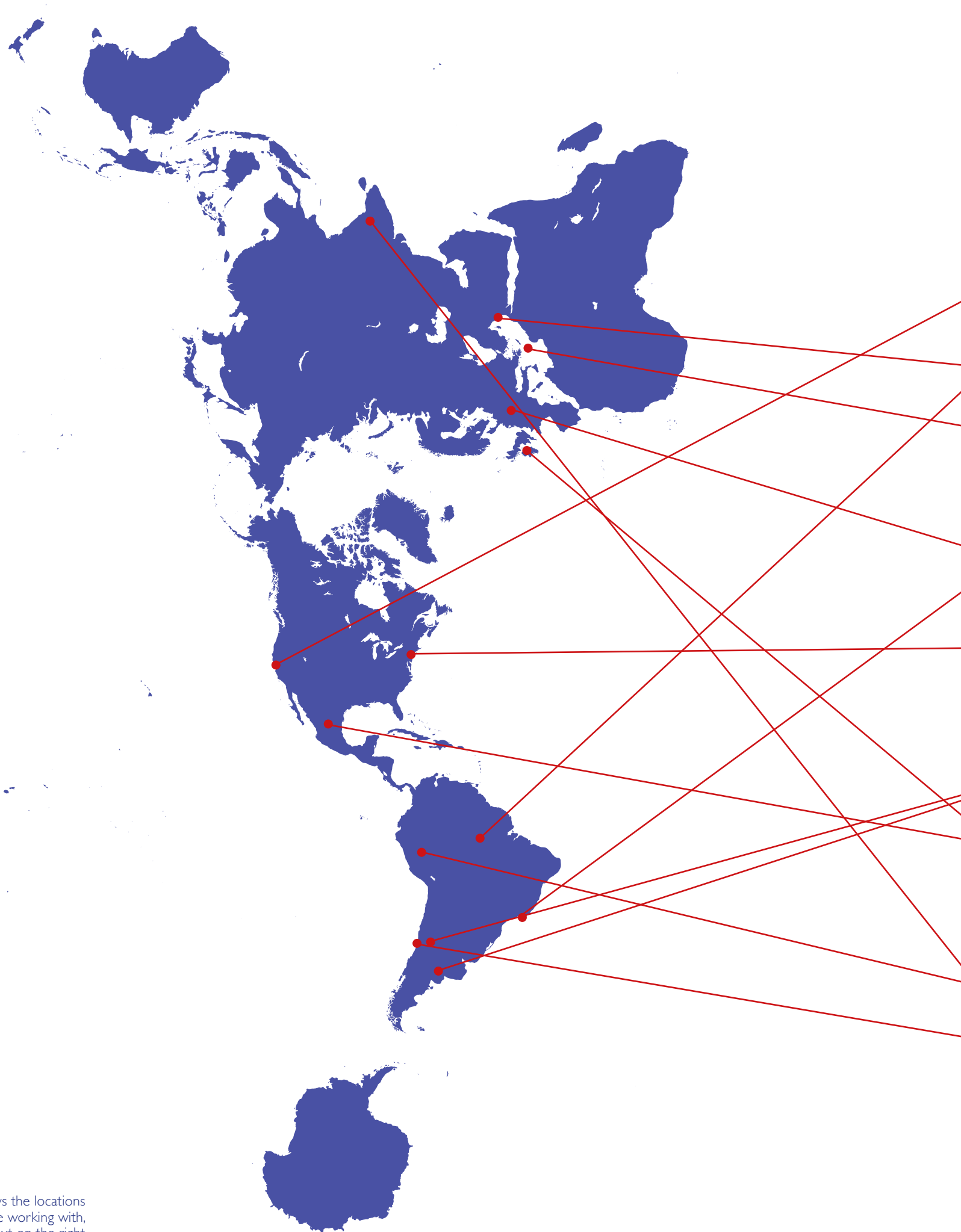

This map shows the locations the authors are working with, whereas the text on the right provides information about the authors' locations.

# Table of Contents

## Introduction

- 12 Editorial – This Is Not an Atlas  
*Severin Halder, Boris Michel / Berlin*
- 26 Counter-Cartographies – The Insurrection of Maps  
*André Mesquita / São Paulo*

## Counter-Cartographies as a Tool for Action

- 38 Mapping the Anti-Eviction Struggle in the San Francisco Bay Area  
*Anti-Eviction Map – Erin McElroy / San Francisco*
- 46 A New Social Cartography  
Defending Traditional Territories by Mapping in the Amazon  
*Projeto Nova Cartografia Social da Amazônia – Alfredo Wagner Berno de Almeida, Sheilla Borges Dourado, Carolina Bertolini / Manaus & São Luis*
- 54 A View from Above – Balloon Mapping Bourj Al Shamali  
*Claudia Martinez Mansell, Mustapha Dakhoul, Firas Ismail / New York & Bourj Al Shamali*
- 60 Mapping Safe Passages  
Real-Time Interventions at the Maritime Borders of Europe  
*Stephan Liebscher, Ina Fisher / Berlin*
- 66 Militarization of Rio de Janeiro's Favelas – Measuring Impacts on the Lives of Young Black Men and Women through Social Cartography  
*Fórum de Juventudes do Rio de Janeiro / Rio de Janeiro*
- 72 Political Action Maps  
Finding your Way in Demonstrations and Protests  
*Kartographische Aktion / Germany*
- 76 This Land Is Your Land  
Strategies for Making the Potential Commons Visible and Actionable  
*596acres – Paula Z. Segal, Mara Kravitz / New York*

## Counter-Cartographies Tie Networks

- 86 X-Ray of Soy Agribusiness in the Pampa and Mega-Mining in the Andes  
*Iconoclastas – Julia Risler, Pablo Ares / Buenos Aires*
- 92 Mapping Global Environmental Conflicts and Spaces of Resistance  
*Environmental Justice Atlas – Leah Temper / Barcelona*
- 98 Collaborative Cartography in Defense of the Commons  
*Geo Communes / Mexico*
- 102 Knitted Flood Wall  
*Martina O'Brien / Dublin*

## Counter-Cartographies Build Political Pressure

- 110 Indigenous Cartography in Acre – Influencing Public Policy in Brazil  
*Comissão Pró-Índio do Acre – Renato Antonio Gavazzi / Rio Branco*
- 116 Making Cartographies of Ourselves  
*CRAC Valparaíso – Paulina E. Varas, José Llano Loyola / Valparaíso*
- 120 A Civic Mapping Project in an Indian Megacity  
The Uses and Challenges of Spatial Data for Critical Research  
*Hyderabad Urban Lab – Harsha Devulapalli, Indivar Jonnalagadda / Hyderabad*





## Counter-Cartographies Build Political Pressure (continued)

- 126 Mapping Sexual Harassment in Egypt  
*HarassMap / Cairo*
- 130 Untangling the Strategies of Capital – Towards a Critical Atlas of Ecuador  
*Colectivo de Geografía Crítica del Ecuador / Quito*
- 136 A Students' Map for a Students' Building  
Working from within and beyond the Map  
*Geoide en Revolución / Buenos Aires*

## Counter-Cartography Is Education

- 144 Counter-Mapping for Resistance and Solidarity in the Philippines  
Between Art, Pedagogy and Community  
*Arnisson Andre C. Ortega, Ma. Simeona M. Martinez, Cian Dayrit,  
Kristian Karlo C. Saguin / Quezon City & Pasig City*
- 152 Mapping Inside (and Outside) the Classroom  
*Nicolás Frank, Fernanda García / Uruguay*
- 158 Protest Map, Cartoon and Propaganda  
The Hidden Object Map Right to the City  
*Marc Amann, Markus Wende / Tübingen & Berlin*

## How to Become an Occasional Cartographer

- 165 Making Maps – A Visual Guide to Map Design with GPS  
*Denis Wood, John Krygier / Raleigh & Delaware*
- 183 Manual of Collective Mapping  
*Iconoclastas – Julia Risler, Pablo Ares / Buenos Aires*
- 205 A Guideline for Solidary Mapping  
*Anna Hirschmann, Raphael Kiczka, Florian Ledermann,  
participants of the Solidary Mapping Workshop / Vienna*

## Counter-Cartographies Create Visibility

- 212 Counter-Mapping Militant Research  
*Counter Cartographies Collective – Liz Mason-Deese, Craig Dalton, Nathan  
Swanson, Tim Stallmann, Maribel Casas-Cortes, Sebastian Cobarrubias /  
North Carolina*
- 222 Mapping the Squatting Movement  
*Pappsatt-Kollektiv – Tobias Morawski / Berlin*
- 228 Emancipatory Mapmaking – Lessons from Kibera  
*Erica Hagen, Julian Stenmanns, Till Straube / Washington D.C. & Frankfurt*
- 234 Mapping Postkolonial  
An Archive of Post/Colonial Traces, Layers and Spectres in Munich  
*mapping.postkolonial.net – Eva Bahl, Simon Goeke, Zara Pfeiffer,  
Peter Spillmann, Michael Vögeli, Philip Zölls / Munich*
- 240 Open-Source Aerial Imagery as a Critique Tool  
The Extractive Geopolitics Project  
*Imaginando Buenas / Montevideo*
- 244 You Must Buy before You Can Fly – The Airport Malls  
*Philippe Rekacewicz / Eydehavn*

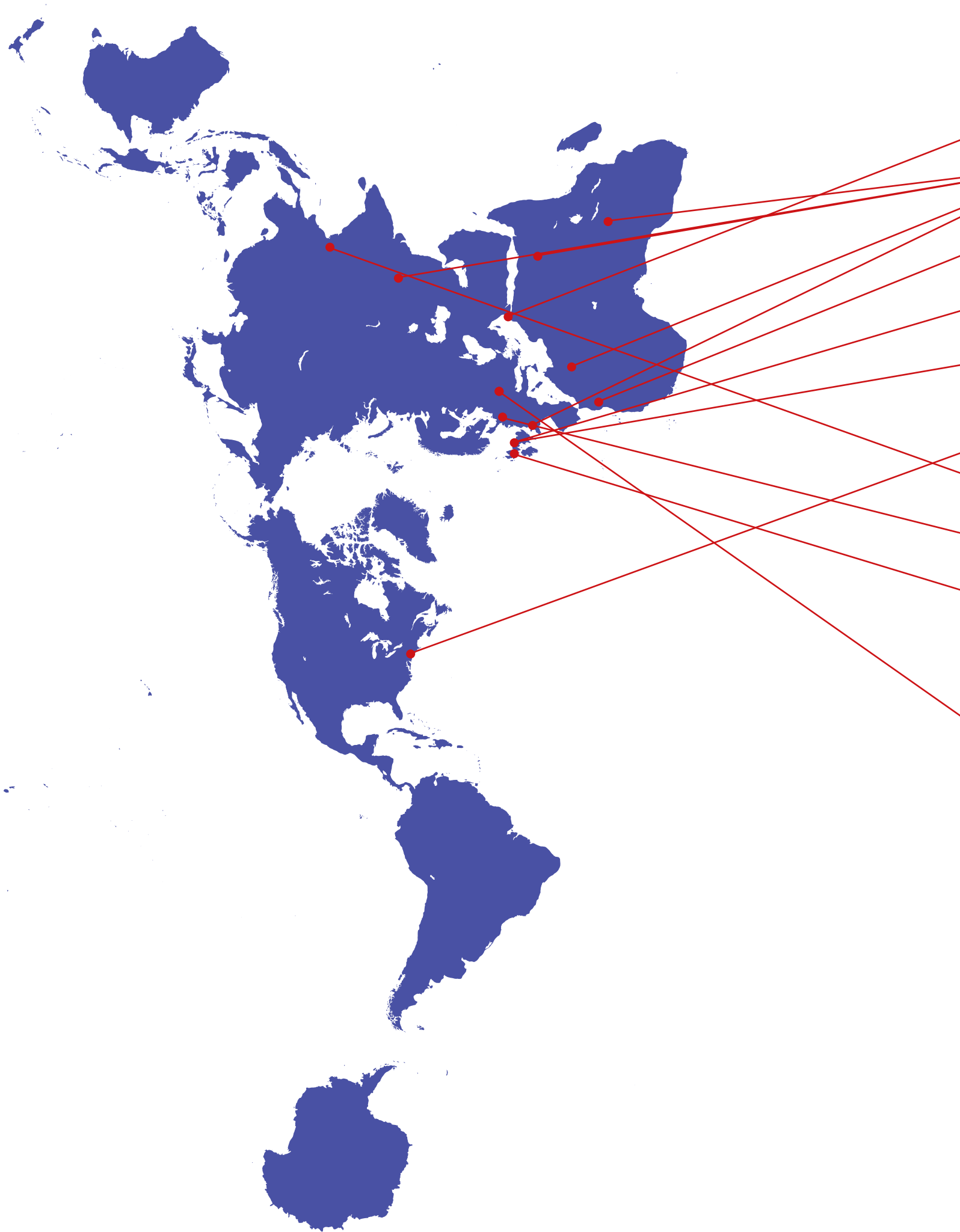

## Counter-Cartographies Show Spatial Subjectivity

- 252 Visualizing the Counter-Narratives of Port Said  
An Experiment of Mapping Social History  
*Nermin Elsherif / Cairo*
- 258 Counter-Cartographies of Exile  
*Sarah Mekdjian, Anne-Laure Amilhat Szary / Grenoble*
- 264 The Materiality Language of Cartography  
Textile Maps of Moroccan Working-Class Neighbourhood in Marrakech  
*Elise Olmedo / Marseille*
- 270 Imaging Homelessness in a City of Care  
Participatory Mapping with Homeless People  
*Oliver Moss, Adele Irving / NewcastleGateshead*
- 276 Tyneside's Skateworlds and Their Transformation – Production and  
Consumption of Participatory Post-Representational Cartographies  
*Jon Swords, Mike Jeffries / Newcastle*
- 282 Far Rock – AnneMarie's Mental Map of New York  
*Aaron Reiss / San Francisco*

## Counter-Cartographies as Self-Reflection

- 286 Information Overload – From the Map to the Ground and Back  
*Elisa T. Bertuzzo, Günter Nest / Berlin*
- 294 C/Artographies of Positionality –  
Or How We Try to Situate Ourselves as a Working Group in Academia  
*Working Group Critical Geographies of Global Inequalities / Hamburg*
- 300 Deep Maps  
*Brett Bloom / Chicago*

## Counter-Cartographies as Critique

- 308 Uneven Digital Geographies ... and Why They Matter  
*Mark Graham, Stefano De Sabbata, Ralph Straumann, Sanna Ojanperä /  
London, Leicester, Oxford, Zürich*
- 316 From Data Commons to (Critical) Cartography –  
Linking Data Sources for a Gender Street Map  
*Florian Ledermann / Vienna*
- 322 Towards unMaking maps – A Guide to Experiments in Paracartography  
*John Krygier, Denis Wood / Raleigh & Delaware*

## This Is Not a Conclusion

- 328 Discussing Counter-Cartographies  
*with Denis Wood, Iconoclastas, Andre Mesquita, Francis Harvey,  
Lize Mogel, Counter Cartographies Collective and Felipe Martín Novoa*
- 339 Glossary



# Introduction



# Editorial – This Is Not an Atlas

Severin Halder, Boris Michel

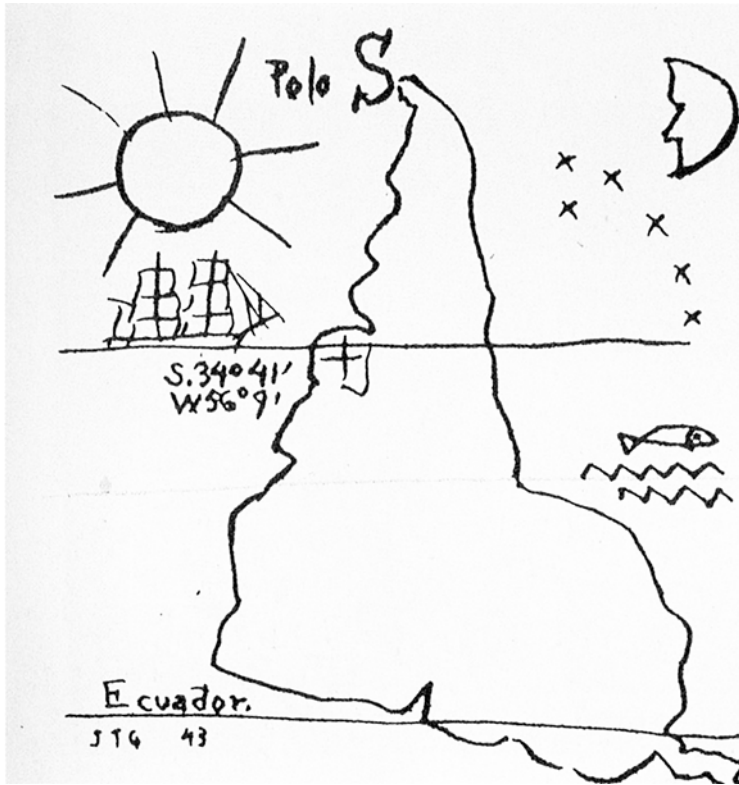

Ever since the first map collections of the late 16th century carried the word "Atlas" on their covers, the notion of an "Atlas" has come with a promise: to show the world as it really is, and to produce true knowledge about the surface of the earth<sup>1</sup>. But as we know, truth and knowledge are deeply linked to power and hegemony. It is no coincidence to find the *Atlas Minor* (see illustration bottom left), compiled by the Flemish cartographer Gerardus Mercator in the early 17<sup>th</sup> century, being decorated with two white men surveying the world (sporting massive beards)<sup>2</sup>. In turn, their object of interest – the globe – rests on the shoulders of Atlas, the Greek titan, and is surrounded by various religious and mythological symbols as well as fragments of ancient architecture. This mobilization of the power of scientific, religious and worldly authorities is characteristic for the rhetoric of maps and atlases.

Over time, atlases have changed: From being rare artefacts in the possession of the rich and powerful they have turned into everyday objects. With the rise of modern nation states and the establishment of geography as a school subject in the 19<sup>th</sup> century, school atlases have not only taught pupils how to read maps but also how to place themselves in the world as citizens-to-be. For this, the school atlas often deals with one's own nation first, cartographically exploring it with great diligence. Only after the "own" spaces have been dealt with, the "rest" can be understood, but often in less detail. This order fundamentally affects young people's worldviews. Supported by the authority and the resources of the state, the market and science, atlases do not only reproduce these dominant actors' worldviews, they also produce realities – such as the idea that the world is the sum of spatially distinct nation states and that this distinction is the natural order of things<sup>3</sup>. Atlases usually appear as very thick books declaring to present a more or less complete description of the world and claiming to show things as – and especially where – they really are. In other words, atlases proclaim truth, neutrality and objectivity and consequently invoke authority and gravitas. Therefore, atlases and maps rarely allow for ambivalence or contradiction. This can be advantageous when navigating home, for example. But as John Pickles reminds us it can also be dangerous:

*"The lack of cartographic 'buts' and 'ifs' gave the cartographer 'much less leeway' to remind the map-reader of the interpretative nature of the mapping process, and, as a result, the map-reader easily falls into the habit of seeing 'the map as a precise portrayal of reality.'" (2004: 35)*

## Not an Atlas?

We do not claim to present an all-encompassing, true-to-scale, and objective view of the world with the collection of maps, that are published in this book. Rather we follow the idea that maps are by no means just representations of reality. Maps articulate statements that are shaped by social relations, discourses and practices, but these statements also influence them in turn. Hence, maps (and atlases) are always political. "In this interplay between facts and perception, the cartographer is both witness and actor. [...] In order to create, or, more accurately: to invent, "his worlds", he finally arrives at a subtle mixture of the world as it is, and the world he desires" (Rekacewicz 2006). Thus, many of the maps presented in this volume are full of "ifs", "buts" and question marks but also of desired worlds.

For some time now, we can witness a growing presence and relevance of maps in art, activism and social movements. This certainly goes hand in hand with new ways of producing, distributing and using maps that lend new weight to them as a medium for communication. Never has it been easier to design and to publish maps online or on paper, even without formal cartographic training. Maps are probably more present in many people's everyday life than ever before. Many critical cartographers are delighted to find the old and institutionalized cartography of universities, publishing houses and the state lose its exclusive power over maps:

*"Cartography Is Dead (Thank God!) Let's admit it. Cartography is dead. And then let's thank our lucky stars that after the better part of a century mapmaking is freeing itself from the dead hand of academia." (Wood 2003: 4)*

Freed from academia's dead hand, more and more radicals and activists use maps as tools for their struggles – be it to protect indigenous territories, to visualize spatial injustices, or to organize protest and resistance. These new, diverse practices and styles of using maps for political and emancipatory means, and the political processes and social forces they contain, were the starting point for this collection of maps we do not call an atlas. We chose to call it Not-an-Atlas because we wanted to break with the conventions of traditional atlases. At the same time we wanted to build on other counter-atlases. This contradiction gave us the feeling of being on the right track. We wanted to be clear about what we do not want to be. At the same time we wanted to show respect to our sources of inspiration.<sup>4</sup>

## The Three Cs: Critical, Counter and Cartography

For us, critical cartography is an opportunity to critically work with maps. The – mostly academic – debate of this name emerged in the late 1980s. In the beginning it focused to a large degree on criticizing maps or, more accurately, on the work done within the discipline of cartography. Cartography, in this sense, refers to a practice strongly institutionalized by the state and by capital. The resulting critique uncovers how maps were complicit in the history of colonialism and nationalism and how they contributed to their stabilization and legitimization. It also traced how maps make social conditions appear natural by connecting them to space. Cartography does not exist outside of power structures, and maps can be powerful devices in society. Not only do they locate and thereby spatialize the natural environment, they also put ownership, rights and social norms in their place.

Critical cartographers therefore critically scrutinized maps in various ways – both methodologically and theoretically – using semiotics, discourse analysis or deconstructivism. This approach is represented most notably by John Brian Harley's *Deconstructing the Map* (1989) and Denis Wood's *The Power of Maps* (1992), in which it is argued that maps should be understood as signs and texts and, by being signs and texts, they should be read critically.

This made many critical geographers and others skeptical regarding the use of maps as tools for the production and visualization of geographic knowledge. Critical geographers and other critical academics, it seemed, did not make maps anymore, as they were quickly labeled to be reductionist, reifying social relations and, accordingly, would be seen as "uncritical". They were frequently considered instruments of positivism as well as of technocratic thought and planning. Against this notion, other critical geographers began to call for *Reclaiming the Map* (Dodge & Perkins 2008). Jeremy Crampton and John Krygier argue to conceive of "critical cartography as a one-two punch of new mapping practices and theoretical critique" (2005: 11). With Not-an-Atlas we intend to follow this call. At the same time, we build upon a long tradition of counter-cartographies – or, rather, multiple traditions in a range of fields, such as the arts, academia or political activism. We understand counter-cartography as a political practice of mapping back.

It was especially artists who initiated the use of maps to criticize, provoke and challenge our ways of thinking about space, place and maps. Examples include the surrealist world map of 1929, or Joaquín Torres' *America Invertida* (see illustration on opposite page top) with its slogan "Our North is the South" from 1943 – both of which subvert the hegemonic, Eurocentric view of our world. This did not only aim at questioning familiar imagi-

nations of the world. Quite often, it was also about challenging the aesthetic customs and boundaries of what actually counts as a map. Just as Lewis Carroll has the bellmen of his 1876 poem "The Hunting of the Snark" (Carroll 1876: 17) present the "perfect and absolute blank" map (see illustration on opposite page) to his crew:

*"What's the good of Mercator's North Poles and Equators,  
Tropics, Zones, and Meridian Lines?"  
So the Bellman would cry: and the crew would reply  
"They are merely conventional signs!"*

*"Other maps are such shapes, with their islands and capes!  
But we've got our brave Captain to thank  
(So the crew would protest) "that he's bought us the best –  
A perfect and absolute blank!"*

Milestones for the fusion of art maps and counter-cartography are, among others, the works of Öyvind Fahlström (since the 1970s) and Mark Lombardi (1990s) (see article page 26). These artists notably contributed to the new wave of counter-cartographies that emerged with the new millennium. They included, for example, the Bureau d'Études (see article page 26) and hackitectura.net<sup>5</sup>. Currently, the Argentinian art and research duo Iconoclasistas plays a major role in the dissemination of counter-cartographies.

Accordingly, they are one of our central sources of inspiration (see second map at the end of the editorial and articles pages 86 & 183). They in turn are influenced by indigenous drawing traditions of Latin America as well as Gerd Arntz's and Otto Neurath's pictograms and mappings. Arntz's and Neurath's work does not only influence present day graphic design. In its core, it was also a project of developing a revolutionary and internationalist tool for communication (Neurath 1933) (see illustration below and on following spread left).

The social and political conflicts around land and place between Patagonia and Alaska actually seem to be a particularly fertile ground for this kind of combination of art, activism and counter-cartography, as groups like the Counter Cartographies Collective (see articles pages 26 & 212), Arte Callejero<sup>6</sup> or the Beehive Collective (see first map at the end of the editorial) impressively indicate.

Counter-maps also grow from a long tradition of post-colonial practices of mapping back. These practices can be traced back to the struggles of First Nations political organizations in Canada and Alaska in the 1970s. The idea behind indigenous counter-cartography is as simple as it is good: "More indigenous territory has been claimed by maps than by guns. This assertion has its corollary: more indigenous territory can be reclaimed and defended

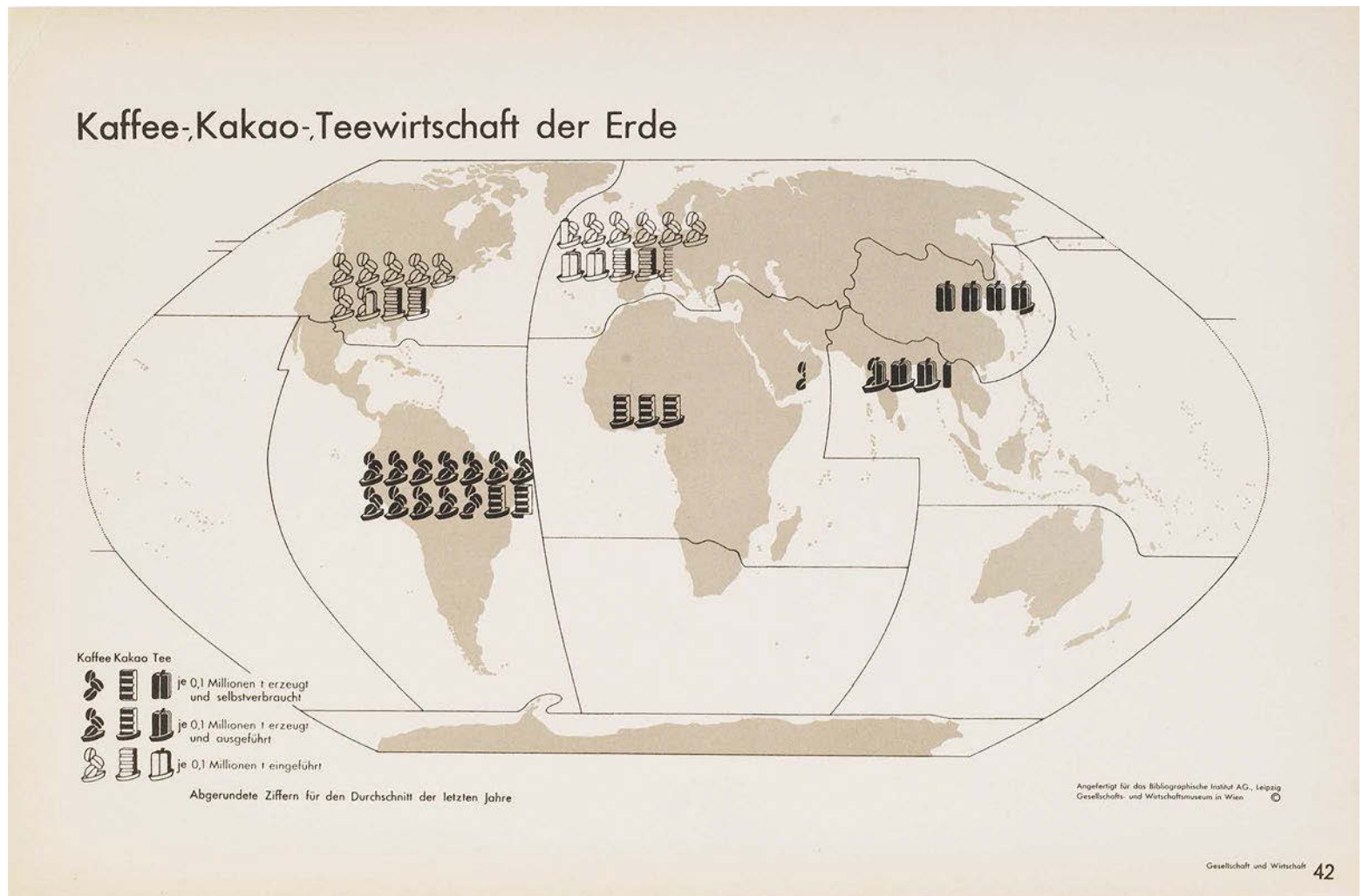



LATITUDE

NORTH

EQUATOR

TORRID ZONE

SOUTH POLE

MERIDIAN

EQUINOX

WEST

EAST

NORTH POLE

ZENITH

NADIR

LONGITUDE

.....  
*Scale of Miles.*

**OCEAN-CHART.**

17

by maps than by guns" (Nietschmann 1995: 37). The mapping of indigenous biographies played a crucial part in the First Nations campaigns for autonomy in the North of the Americas. This was eventually successful: not only did it lead to the establishment of Nunavut, a self-governed Inuit territory of two million square kilometers in northern Canada (see illustration on opposite page top); it also initiated a spreading of indigenous counter-mappings all over the world<sup>7</sup> (see articles pages 46, 110, 130 & 144). Mapping struggles for indigenous territories and rights are a central chapter in the history of counter-cartography. Even the term "counter-mapping"<sup>8</sup> was coined by Nancy Lee Peluso (1995) working with the Dayak in Indonesia, using maps for (re)claiming their land.

Beyond appropriating western map practices for indigenous purposes, however, there have always been other forms of spatial representation – incongruent with western cartography. Some Aztec codices could be seen as an example of these (see illustrations on opposite page bottom). At times, these geographies of words and images, songs or handicraft even merged with colonial maps, as in the case of Tupaia's map<sup>9</sup> (see illustration this page right).

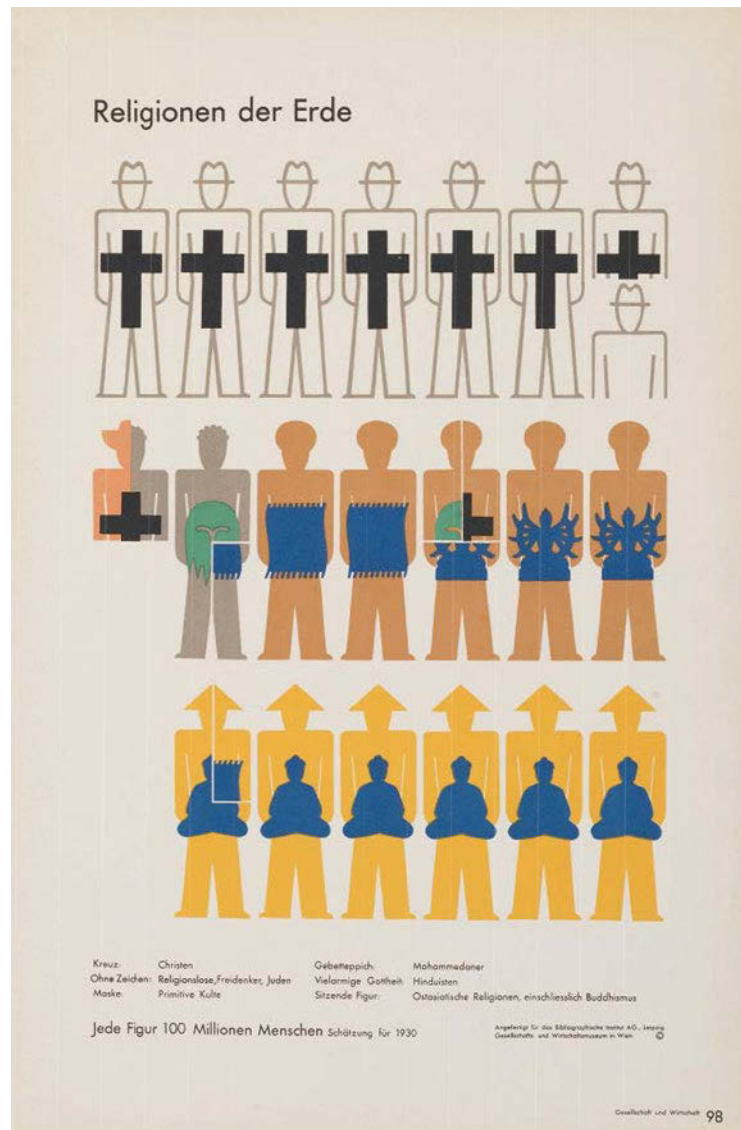

Just by the simple fact of their existence, indigenous geographic representations challenge dominant cartographic imaginations and methods that exclude all non-European modes of knowledge and representation. By reflecting dominant notions of territoriality and shedding light on different human-space interactions, indigenous cartography serves as inspiration for non-hegemonic worldviews and emancipatory practices.

At the same time, indigenous counter-mappings often contain a paradoxical element: In order to be heard and recognized, the claim for territory and empowerment has to translate indigenous cosmologies into dominant cartographic tools. Hence, there is always the danger of distorting original messages or intentions, and to become instrumentalized by those in power. Precisely because maps are powerful tools, it is necessary to keep questioning and reinterpreting them in order to make sure they are still useful for emancipatory purposes.

*"The fact that groups across the political spectrum create these sorts of maps illustrates that counter-mapping itself is not necessarily politically progressive, but that geographical imaginations are important sites of struggle." (Wood cited from Counter Cartographies Collective, Dalton & Mason-Dese, 2012: 443)*

When dealing with geographical imaginations in an emancipatory way, William Bunge's work is an important reference (especially for us as geographers). His geography from below emerged in Detroit's periphery and aimed at building cartographic tools for marginalized communities. This type of counter-cartographic culture utilizes simple and vivid cartographic language in order to promote geographical alphabetization<sup>10</sup> and the self-determination of local communities (see illustration on following spread).

Today the battle over geographical imaginations is very much alive and well. In that sense, Not-an-Atlas is our contribution to this contested practice. At the same time, it is necessary to stress that counter-cartographies can only be "a departure point or a tool that can aid in analysis but do not speak for themselves" (Paglen 2007: 43): the map can never be the territory (see article page 86) and the struggles will not be decided on paper.

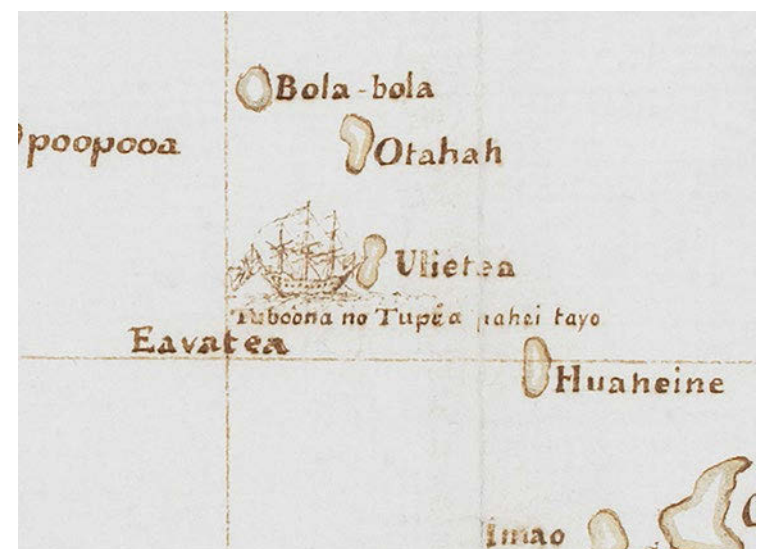

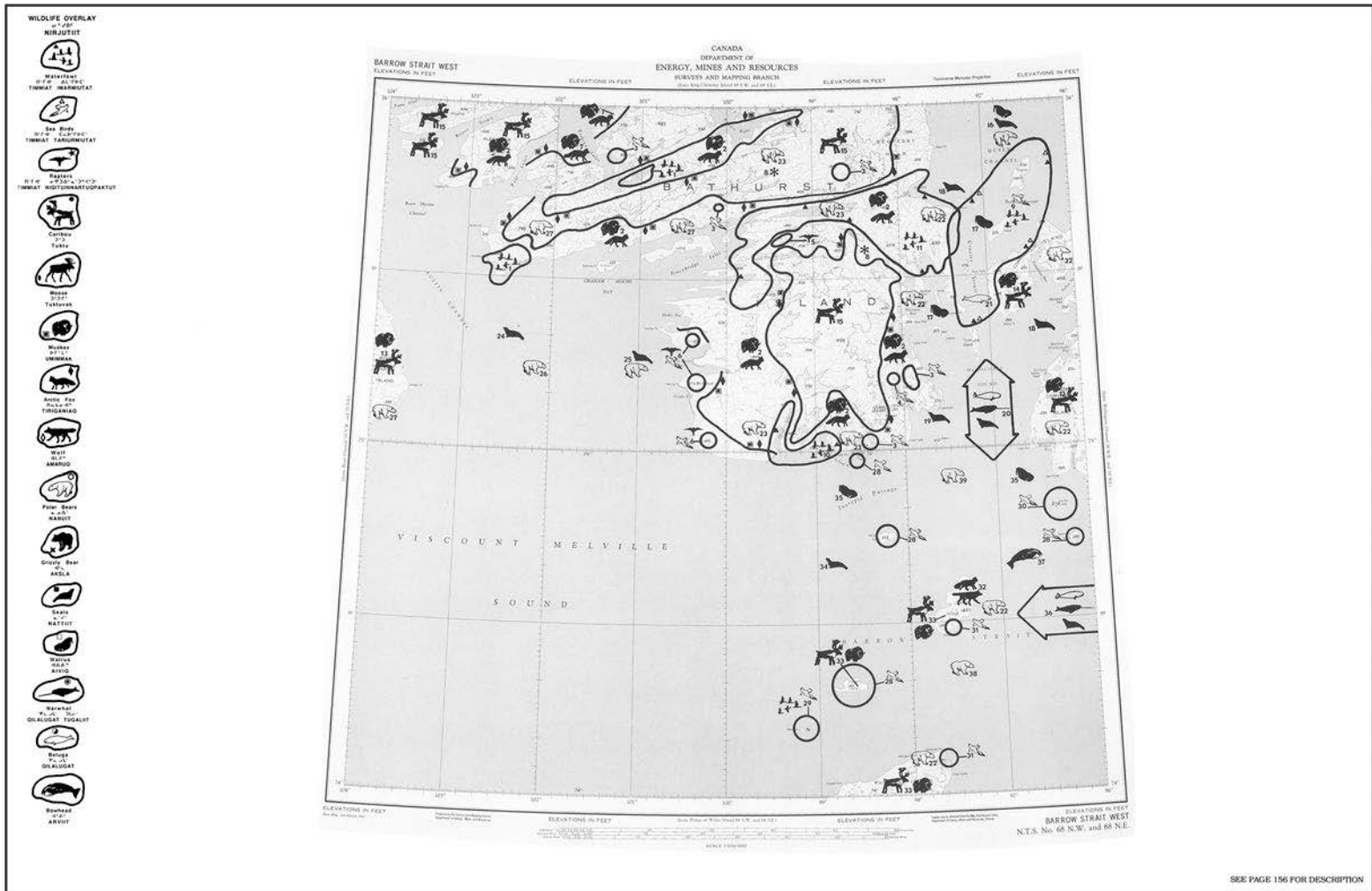

SEE PAGE 156 FOR DESCRIPTION

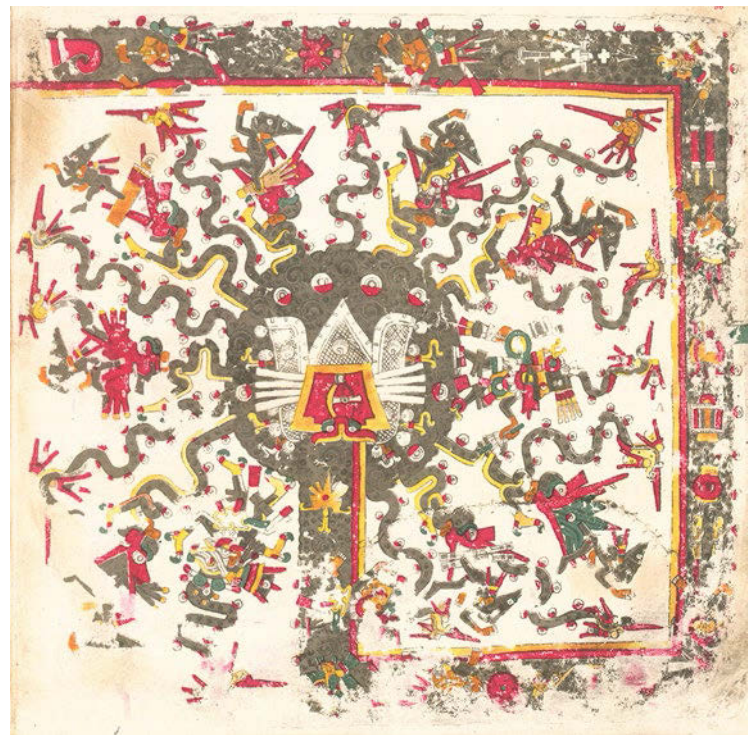

## This Is a Global Collection of Counter-Cartographies

The current panorama of counter-cartographies is as diverse as the roots of critical mapping. Accordingly, Not-an-Atlas collects a very broad range of different contributions, originating from various contexts, and utilizing diverse methods of creation and presentation. Our aim is not to tell a coherent story of counter-cartography, or to provide a simple template for critical mapping. Rather, we would like to give an impression of how open and diverse the field has become, especially due to the practices of people without formal cartographic training. However, with Not-an-Atlas we do not only intend to show but also to contribute to this opening up of actors, topics and forms of map-making. We would like to give space to counter-hegemonic worldviews and at the same time hope to support practices of resistance. And we intend to inspire you to pick up this practical, powerful tool – without losing sight of its pitfalls. Not-an-Atlas deals with counter-cartographies from different contexts and regions, with maps that were produced for various reasons with a wide range of techniques, practices and people. These counter-cartographies largely exist beyond the traditional spheres of cartography, and in most cases their creators are primarily activists, critical educators, militant researchers, artists and/or part of social movements. They see mapping as a means to an end: They map for a cause.

To get some form of order into this heterogeneous field, which at the same time challenges order, we tried to cluster the maps of Not-an-Atlas into chapters – a challenging task. There could have been other chapters. At the end we decided to group the maps and projects around their causes and motivations even if most of the maps have more than just one reason to exist. After defining the chapters, we ordered the maps within them, as far as possible, from concrete "maps" to abstract "mappings".

In the first chapter the maps are used as a **Tool for Action**, to directly change the space around us. In the second chapter maps

are used to **Tie Networks** for fostering dialogue and exchange among them. In the third chapter maps serve to uncover social problems and to **Create Political Pressure**. In the fourth chapter **Counter-Cartography is Education**: maps can be part of critical educational work, not only serving to criticize hegemonic cartographic images, but also as an invitation to **Become an Occasional Cartographer** through self-organized mapping processes as can be seen in the fifth chapter. As chapter six shows, counter-cartographies **Create Visibility** for "invisible" groups and processes, breaking the cartographic silence. In chapter seven counter-maps **Show Spatial Subjectivity**, empowering people to visualize their personal geographies and perceptions of space. This goes hand in hand with their potential to initiate and support processes of **Self-Reflection** shown in chapter eight. In the final chapter, counter-cartographies articulate **Critique** of society, of dominant cartographic imaginations and of critical maps themselves. The collection in your hands wants to reflect these various approaches and aims.

Not-an-Atlas focuses on discussing the practical aspects of mapping projects. This includes not only a presentation of various methods and techniques for creating maps, but also an exploration of different political topics and regional contexts in which maps matter. It becomes clear that a convergence of critical-cartographic and political actors can lead to productive interactions. Not-an-Atlas understands itself as colorful panorama, displaying the range of possibilities for using critical maps for political struggles and emancipatory education. Not-an-Atlas seeks to inspire, to document the under-represented and to be a useful companion when becoming a counter-cartographer oneself. This is how we would like to encourage a critical reflection of dominant spatial imaginations. We want to support social struggles by presenting maps as a useful tool for these struggles.

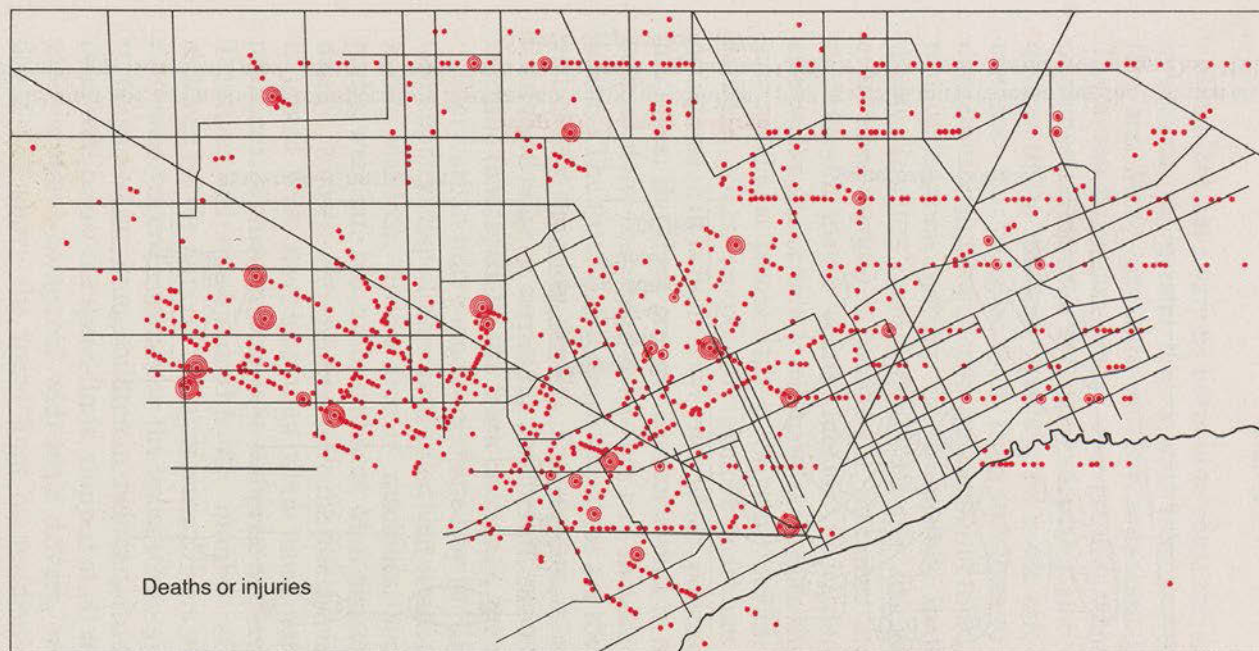

Map 2.16 Children's automobile 'accidents' in Detroit

## How to Edit and Reflect Counter-Cartographies Collectively as Activists and Academics?

Both our activist experiences with collective and critical mapping workshops as *kollektiv orangotango*<sup>11</sup> as well as our individual and academic engagements with maps served as starting points for *Not-an-Atlas*. In the spring of 2015 we released a Call for Maps in English, German and Spanish, inviting everyone engaged with practices of critical mapping to send us ideas, texts, photos and, of course, maps. We were overwhelmed by the resonance! Nearly 150 submissions found their way to us. Some of them came from places, struggles and activists we had not heard of before; others came from long-time companions and friends. Among them were contributions from well-known critical cartographers, activists, and social movements who have been working with maps for many years; but even more emerging mapmakers sent us their proposals. What followed were exciting three years of discussing, selecting and editing the various maps and projects. Again and again we had to ask ourselves: What actually makes a map (not) critical? And what do we (not) have in mind when working on a counter-atlas? We also had to continually negotiate between more activist and more academic modes of knowledge production – be it in regards to the content of the maps or in regards to our own mode of working and living. With the large number of submissions, *Not-an-Atlas* quickly outgrew its initial frame in terms of involved languages, time and resources. The resulting process of collective learning therefore included various challenges, personal fluctuations and surprises.

The exciting insights we were able to gather regarding various processes connected to mapping and resistance, as well as growing as a network, are the fruits of this labor. With *Not-an-Atlas*, we hope to strengthen and to contribute to this kind of processes and networks in analog and digital ways (see [notanatlas.org](http://notanatlas.org)).

The following 330 pages aim to inspire current debates about maps, and to promote counter-mapping practices. *Not-an-Atlas* wants to contribute to emancipatory transformations on the ground by supporting counter-cartographies within and beyond these pages. Finally – and maybe most importantly – we see this book as a guide pointing at many possible worlds, and as an invitation to create more of them: on paper, online and in space.

*Special thanks to Laurenz Virchow, Karl Heyer and Philip Boos for their help with editing and translating this text.*

P.S. *Kollektiv orangotango+* would like to thank those who supported and accompanied us during this journey: Special thanks go out to Christian Bittner, Matze Jung, Dirk Neumann and Verena Schreiber, who helped to put this project on track. We want to express special thanks to Steffen Kühne from the Rosa-Luxemburg-Stiftung, Christa Müller from *anstiftung*, Karin Werner from *transcript*, Jens Marquardt from ASA FF e.V. and Markus Mender from *Le Monde Diplomatique* for their support and trust. We want to give shout-outs to Sebastian Hilf from *kollektiv orangotango*, Cornelius Sutter from *Nachbarschaftshaus Urbanstraße e.V.*, *Handlungsspielraum Berlin*, Jon Richter from *TransforMap*, the *Jugendbildungsnetzwerk* of the Rosa-Luxemburg-Stiftung, Jonathan Wright and Carla Guerrón-Montero for providing practical help when we needed it. We also thank our fellow counter-mappers Julia Risler and Pablo Ares from *Iconoclastas*, Tim Stallmann from the *Counter Cartographies Collective* and countless critical cartographers and geographers who guided us throughout the last decade. Last but not least, we want to show our respect to all the social movements, activists and academics gathered in this book. Without your daily struggles this *Not-an-Atlas* would be pointless.

## Endnotes

1. In its German edition the *Atlas Minor* is a "short but thorough description of the entire world and all of its parts" (Mercator, 1651).
2. At this point it should not be concealed that the authors of this text are white European males as well, one of which is also bearded. This is why we would like to distance ourselves as much as possible from the claim of being able to measure out the world of counter-cartographies since this would be presumptuous. We seek to trade assumed objectivity and mathematical precision for respect and modesty towards all actors who take care of their daily territories by defending them against destruction, capitalism, colonialism, nationalism, racism, sexism – also with the help of maps.
3. Maps are powerful since they are not only a product of societal structures but also a producer of social realities. Maps do not only represent realities by building symbolic orders and hierarchies; they also create realities while being part of the interaction between people and their environments (Pickles, 2004).
4. This is why we would like to refer to atlases, which break with the traditional image of an atlas, for example: *An Atlas of Radical Cartography* (Mogel & Bhagat, 2007), *Everything sings: Maps for a Narrative Atlas* (Wood, 2010), *The Nuclear War Atlas* (Bunge, 1982), *Atlas der Globalisierung* (Le Monde Diplomatique 2003-2015), *The Nunavut Atlas* (Riewe, 1992), *The Maya Atlas* (Toledo Maya Cultural Council, 1997), *Food: An Atlas* (Jensen & Roy, 2012), *We Are Here Map Archive* (see [mapsarchive.wordpress.com](http://mapsarchive.wordpress.com)) and *antiAtlas of Borders* (see [antiatlas.net](http://antiatlas.net)). So even if we consider *Not-An-Atlas* to be a counter-atlas, it is not *the* counter-atlas. "Rather, it is one of many possible atlases, given the abundance of artists, architects, and others using maps and mapping in their work" (Mogel & Bhagat, 2007: 6).
5. *Hackitectura* (2002-2011) was a group of architects, programmers, artists and activists. In their work, they created a fusion of theoretical research with emerging territories of physical and digital movements. Their famous counter-cartography of the Straits of Gibraltar draws an alternative image of the Moroccan-Spanish border. The map shows the existing networks and flows of migration, communication and capital in a heavily monitored border region with the idea to reshape it (see [hackitectura.net](http://hackitectura.net)).
6. The Argentinian *Grupo de Arte Callejero* is composed of artists, photographers and designers. They work closely with social movements like H.I.J.O.S (an organization created by the children of the victims of the military dictatorship). With their series of maps *Aqui Viven Genocidas* (2001-2006) the *Grupo de Arte Callejero* actively participated in the *escraches*, which translates into acts of public shaming to condemn the injustice, violence and genocides committed during the military dictatorship (see [grupodeartecallejero.wordpress.com](http://grupodeartecallejero.wordpress.com)).
7. Some examples for relevant indigenous mapping projects and groups from different regions are *The Nunavut Atlas* (Riewe, 1992), *The Maya Atlas* (Toledo Maya Cultural Council, 1997), *Aboriginal Mapping Network* ([nativemaps.org](http://nativemaps.org)) and *Nova Cartografia Social da Amazonia* (see article page 46). It seems that China is the only region around the world with an indigenous population but without an indigenous counter-mapping culture (Rundstrom, 2009: 316).
8. In the meantime a lot of different concepts that have been interlinked with other counter-cartography besides counter-mapping, such as alternative cartography, bioregional mapping, collective mapping, community mapping, counter-hegemonic mapping, ethno cartography, ethno mapping, green mapping, mapping back, participatory rural appraisal, public participation geographic information system, (public) participatory mapping, radical cartography, subversive mapping and remapping.
9. In 1769 the legendary Polynesian sailor Tupaia, son of a preacher family from Raiatea, accompanied James Cook on the *Endeavour* and drew the cartographic representation of the region Pacific islands (Eckstein & Schwarz 2015). Tupaia's chart of 74 islands can be seen as a fusion of Oceanic geographical imaginations like star compasses with European cartography. Di Piazza and Pearthree (2007) propose such a reading for Tupaia's drawing: "Tupaia's chart, while having the appearance of a map, is in fact a mosaic of sailing directions or plotting diagrams drawn on paper, similar to those made by master navigators tracing lines in the sand or arranging pebbles on a mat to instruct their pupils" (Di Piazza & Pearthree, 2007: 321). This means that Tupaia was applying a cartographic technique with the center point or island of departure as a "subjective coordinate". This geographical imagination contrasts with the coordinates in Cartesian space where islands are defined absolutely and not in relation to the navigator (Di Piazza & Pearthree, 2007: 326).
10. The term alphabetization is used by Paulo Freire in his *Pedagogy of the Oppressed* (1968) to describe an emancipatory learning process. As *kollektiv orangotango*, we see our own collective mapping practice as a continuation of the popular education of Freire and Bunge and as a collective process of geographical alphabetization in spaces of everyday action (Halder, 2018: 308).
11. *Kollektiv orangotango* was founded in 2008. Since then it has been constantly developing through a network of critical geographers, friends and activists who deal with questions regarding space, power and resistance. With our geographical activism, we seek to support processes and oppositional actors who instigate social change by prefiguring social alternatives. We conduct emancipatory educational work as well as concrete political and artistic interventions. These are supposed to enforce reflections on and changes of social conditions. Since 2010 we have been engaged in processes of collective and critical mapping within the fields of right to the city, (urban) agriculture, critical pedagogy, alternative housing and solidarity economy, mostly in Europe and also in Latin America. But *kollektiv orangotango* also functions as a platform for different actions. In the case of *Not-an-Atlas*, its publication was realized by *kollektiv orangotango* in cooperation with other activists and academics. That is the reason why it was named *kollektiv orangotango+*.

## References

- Bunge, W. 1988. *The Nuclear War Atlas*. New York: Blackwell.
- Caroll, L. 1876. *The Hunting of the Snark*. London: Macmillan.
- Counter Cartographies Collective, Dalton, C. & Mason-Deese, L. 2012. Counter (Mapping) Actions: Mapping As Militant Research. *ACME: An International Journal for Critical Geographies*, 11 (3): 439-66.
- Crampton, J. & Krygier, J. 2005. An Introduction to Critical Cartography. *ACME: An International E-Journal for Critical Geographies*, 4 (1): 11-33.
- Di Piazza, A. & Pearthree, E. 2007. A new reading of Tupaia's chart. *Journal of the Polynesian Society*. 116 (3): 321-340.
- Dodge, M. & Perkins, C. 2008. Reclaiming the Map. *Environment and Planning*, 40: 1271-1276
- Eckstein, L. & Schwarz, A. 2015. Tupaia's Karte – Die polynesische Kunst der Navigation. *Le Monde Diplomatique*, monde-diplomatique.de/artikel/!5227784, 3 July 2018.
- Freire, P. 1968. *Pedagogia do Oprimido*. Rio de Janeiro: Paz e Terra.
- Halder, S. 2018. *Gemeinsam die Hände dreckig machen – Aktionsforschungen im aktivistischen Kontext urbaner Gärten und kollektiver Kartierungen*. Bielefeld: transcript.
- Harley, J. B. 1989. Deconstructing the Map. *Cartographica*, 26 (2): 1-20.
- Jensen, D. & Roy, M. eds. 2012. *Food: An Atlas*. Oakland: Guerrilla Cartography.
- Le Monde Diplomatique 2003-2015. *Atlas der Globalisierung*.
- Mercator, G. 1651. *Atlas minor, das ist eine kurze jedoch grundliche Beschreibung der gantzen Weltdt*. Amsterdam: Joannes Janssonius
- Mogel, L. & Bhagat, A. eds. 2007. *An atlas of radical cartography*. Los Angeles: Journal of Aesthetics & Protest Press.
- Neurath, O. 1933. *Bildstatistik nach Wiener Methode in der Schule*. Wien: Deutscher Verlag für Jugend und Volk.
- Nietschmann, B. 1995. Defending the Miskito Reefs with Maps and GIS. Mapping With Sail, Scuba, and Satellite. *Cultural Survival Quarterly*, 18 (4): 34-37.
- Paglen T. 2007. Mapping Ghosts. Visible collective talks to Trevor Paglen. In: Mogel, L. & Bhagat, A. eds., *An Atlas of Radical Cartography*: 39-50. Los Angeles: Journal of Aesthetics & Protest Press.
- Peluso, N. L. 1995. Whose woods are these? Counter-Mapping Forest Territories in Kalimantan, Indonesia. *Antipode*, 27 (4): 383-406.
- Pickles, J. 2004. *A History of Space. Cartographic Reason, Mapping and the Geo-coded World*. London: Routledge.
- Rekacewicz, P. 2006. Der Kartograph und seine Welten. *Le Monde Diplomatique*, monde-diplomatique.de/artikel/!377853#anker1, 3 July 2018.
- Riewe, R. 1992. *Nunavut Atlas*. Edmonton: Canadian Circumpolar Institute.
- Rundstrom, R. 2009. Counter-Mapping. *International Encyclopaedia of Human Geography*: 314-318. Amsterdam: Elsevier.
- Toledo Maya Cultural Council 1997. *Maya Atlas - The Struggle to Preserve Maya Land in Southern Belize*. Berkley: North Atlantic Books.
- Wood, D. 2010. *Everything Sings: Maps for a Narrative Atlas*. Los Angeles: Siglio Press.
- Wood, D. 2003. Cartography is Dead (Thank God!). *Cartographic Perspectives*, 45: 4-7.
- Wood, D. 1992. *The Power of Maps*. New York: Guilford.

## Illustrations

- page 12 top: Joaquín Torres, America Invertida, 1943, Museo Juan Manuel Blanes, Montevideo, Public Domain (according the Uruguayan Law)
- page 12 bottom: Gerhard Mercator & Jodocus Hondius, Cover of the Mercator-Hondius Atlas Minor, 1607, Statens kartverk Sjø, Public Domain
- page 14: Otto Neurath & Gerd Arntz, Kaffee-, Kakao- Teewirtschaft der Erde, Gesellschaft und Wirtschaft - Bildstatistisches Elementarwerk, page 42, 1930, all rights reserved © Österreichisches Gesellschafts- und Wirtschaftsmuseum
- page 15: Lewis Carroll, Ocean-Chart, The Hunting of the Snark, 1876/1931, Macmillan, Public Domain
- page 16 left: Otto Neurath & Gerd Arntz, Religionen der Erde, Gesellschaft und Wirtschaft - Bildstatistisches Elementarwerk, page 98, 1930, all rights reserved © Österreichisches Gesellschafts- und Wirtschaftsmuseum
- page 16 right: Tupaia, Detail of Raiatea from Tupaia's Chart, Indigenous intermediaries: New perspectives on exploration archives, page 151, circa 1769, all rights reserved British Library, BL Add Ms 21519 © British Library Board
- page 17 top: Rick Riewe, Nunavut Atlas, page 43 (wildlife overlay), 1992, The University of Alberta Press & Tungavik Federation of Nunavut, all rights reserved © Canadian Circumpolar Institute
- page 17 bottom: unknown author, Codex Borgia / Codex Yoalli Ehēcatl, page 44 & 36, pre-Columbian era/1898, FAMSI, Public Domain
- "Pages 29 through 46 of the codex constitute the longest section of the codex, and the most enigmatic. The pages refer to different veintena festivals. Together these images represent a 20-day period for the veintena cycle. The glyphs refer to dry and rainy seasons. They apparently show a journey but the complex iconography and the lack of any comparable document have led to a variety of interpretations ranging from an account of actual astronomical and historical events, to the passage of Quetzalcoatl – as a personification of Venus —through the underworld, to a "cosmic narrative of creation". (en.wikipedia.org/wiki/Codex\_Borgia)
- page 18: William Bunge, Children's Automobile "Accidents" in Detroit, Nuclear War Atlas, 1988, Basil Blackwell, licensed under the Creative Commons Attribution-NonCommercial-ShareAlike 3.0 (CC BY-NC-SA 3.0) Unported License, Cornell University – PJ Mode Collection of Persuasive Cartography. "This map suggests that the high rate of injury of inner-city Detroit school children by automobiles shouldn't really be attributed to 'accident', but to the callousness of officials who allow dangerous conditions to persist in 'the geography of the streets' where the poor go to school, as opposed to suburban 'cul-de-sacs'. [...] A 1971 version of this map was more bluntly entitled 'Where Commuters Run Over Black Children on the Pointes-Down-town Track.'" (digital.library.cornell.edu/catalog/ss:19343514)
- "A young black woman, Gwendolyn Warren, from Fitzgerald in Detroit ... was filled with hatred towards me because I did not notice the children being murdered by automobiles in front of their homes or children starving in front of abundant food." (Bunge, W. cited from Barnes, T.; Heynen, N. 2011: William W. Bunge (1971) Fitzgerald: Geography of a Revolution. Cambridge, MA. Schenkman Publishing Co. *Progress in Human Geography*, 35 (5): 712-715)
- page 22-23: Beehive Design Collective, The Colonizer's View from Mesoamérica Resiste
- "With the shutters closed, the outside of the poster resembles an old Spanish conquistador's map of Mesoamerica. The map is a top-down look at the region and draws parallels between colonial history and modern-day capitalism. Outsiders who have no connection with the land have drawn this map, with motives of extraction and profit." (beehivecollective.org/graphics-projects/mesoamerica-resiste/)
- "The Beehive Design Collective is a wildly motivated, all-volunteer, activist arts collective dedicated to "cross-pollinating the grassroots" by creating collaborative, anti-copyright images for use as educational and organizing tools". (beehivecollective.org/about-the-hive/who-we-are/)
- page 24-25: Iconoclastas, ¿A quién pertenece la tierra? / Who owns the land? - Mapa Mundi / World Map, 2017, licensed under the Creative Commons Attribution-NonCommercial-ShareAlike 4.0 (CC BY-NC-SA 4.0) International Public License.





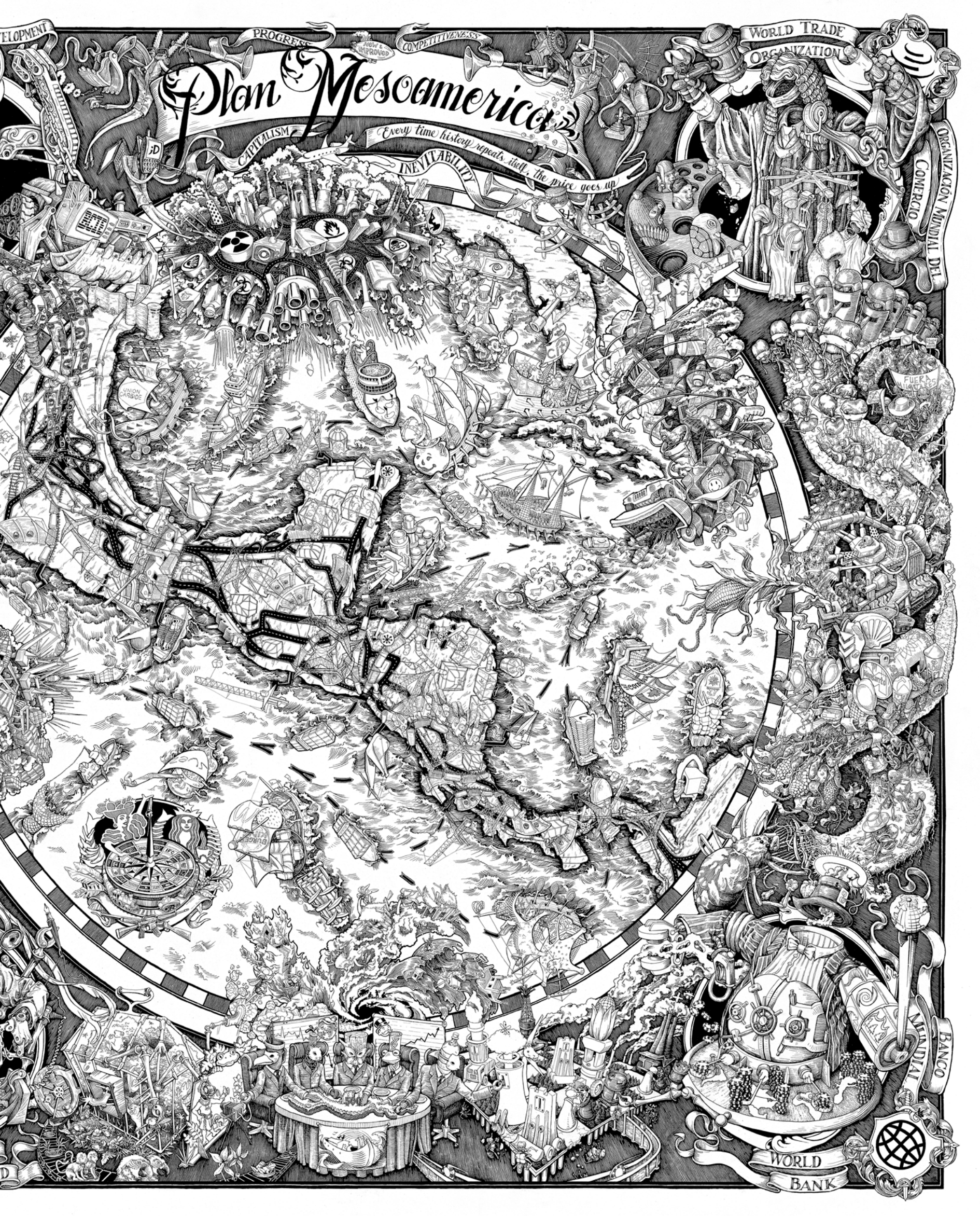

# Plan Mesoamerica

DEVELOPMENT

PROGRESS

POST & APPROVED

COMPETITIVENESS

WORLD TRADE ORGANIZATION

ORGANIZACION MUNDIAL DEL COMERCIO

Every time history repeats itself, the price goes up

INEVITABILITY

UNION ARBIDE

WORLD BANK

BANCO MUNDIAL

FUERZAS ARMADAS

WORLD BANK



**Leyendas / Legend**

Zona que abarca la mayor diversidad biocultural de la tierra: más del 65% de las lenguas, de la flora y de la fauna. Region with the largest biocultural diversity on the planet: over 65% of languages and wildlife.

Países cuya población rural supera el 50% del total. Countries with more than 50% of rural population.

Países con una población rural de más de 10 millones de mujeres. Countries with a rural population of over 10 million women.

Países donde está presente la "Via Campesina", organización internacional de 200 millones de personas de áreas rurales que trabajan para defender sus territorios y la soberanía alimentaria. Countries with the presence of "Via Campesina", an international organization of 200 million people across rural areas working to defend their territories and food sovereignty.

Principales causas de la explotación que causa el éxodo de población. Main disposessions causing mass exiles.

- Violencia armada / Armed violence
- Megaminería / Mega mining
- Hidrocarburos / Hydrocarbons
- Monocultivos OGM / GMO monocultures



**Megaciudades y crisis ambiental**

En 2007, por primera vez en la historia, la población residente en ciudades es mayor a la población campesina. Aún así, en las zonas rurales viven unas 3.400 millones de personas que se dedican a producir alimentos y más de la mitad son mujeres. Ellas sostienen prácticas de reciprocidad, preservan las memorias y saberes ancestrales, trabajan y cultivan la tierra en equilibrio con los ciclos de la naturaleza; y aportan una solución a la crisis ecológica y a los desastres climáticos, cada vez más frecuentes en el mundo.

**Megacities and environmental crisis**

In 2007, for the first time ever, the population living in cities surpassed the one living in the countryside. However, some 3.4 billion people still live in rural areas and work in food production—more than half of them are women. They support reciprocity practices, preserve ancestral memories and know-how, work and cultivate the land in harmony with the cycles of nature, and provide a solution to the environmental crisis and the increasing climate-related disasters worldwide.

**Trabajo rural y doméstico**

Estas 1.700 millones de mujeres representan un 25 % de la población mundial, y alimentan a un 70% de los habitantes del planeta. Las mujeres rurales, además del cuidado de sembradíos, la obtención de agua y leña y la cría de animales; realizan un trabajo invisible y no remunerado: el doméstico, el cual incluye el cuidado de los hijos y de personas enfermas, la limpieza del hogar y la elaboración de alimentos, todas labores consideradas como una extensión (obligada) de sus tareas de reproducción biológica.

**Rural and domestic work**

These 1.7 billion women represent 25% of the world population and feed 70% of the world population. Aside from tending crops, gathering water and firewood, and raising animals, they perform invisible work. They are not paid for their domestic work, which includes caring for children and the sick, cleaning the home, and preparing food—all activities that are considered an (obligatory) extension of their biological reproductive functions.

Países donde se encuentran las casas centrales de las principales empresas armamentistas, petroleras, mineras, alimenticias, semillas transgénicas y agroquímicas.  
Countries with headquarters of leading companies in the oil, mining, food, GMO seed, and agrochemical sectors.

20  
15  
10  
5  
Ciudades de más de 10 millones de habitantes.  
Cities with more than 10 million inhabitants.



**Sudamérica:** Las mujeres de movimientos rurales de recuperación territorial, frenan la acción expropiadora y privatizadora de las corporaciones de agrobiznes y sus monocultivos de soja y maíz.

**South America:** Women of the rural movements for territorial reappropriation resist the expropriation and privatisation attempts of large agribusiness corporations and to soy and maize monocultures.

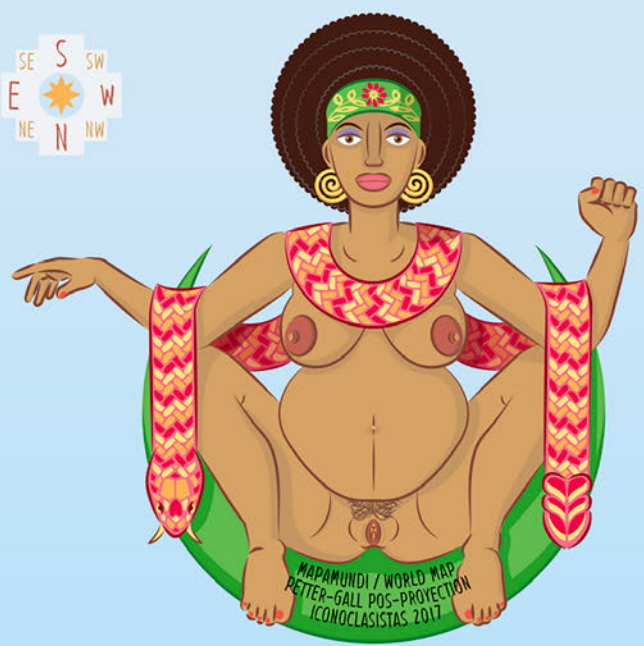

## ¿A QUIÉN PERTENECE LA TIERRA? WHO OWNS THE LAND?

En un mundo donde los cuerpos y territorios creadores de vida, son considerados objetos de conquista, expropiados en actos neocoloniales y capitalistas, y amenazados por una violencia machista y patriarcal que se manifiesta en múltiples dimensiones; las mujeres resisten y organizan sus comunidades a través de economías del cuidado, protegiendo los bienes comunes y la soberanía alimentaria.

In a world where bodies that give life and territories are considered objects of conquest, plundered by neocolonial capitalist acts and threatened by multiple forms of sexist male patriarchal violence, women resist and organise their communities through care economies, protecting common goods and food sovereignty.

38. Equatorial Guinea  
39. Benin  
40. Togo  
41. Central African Republic  
42. Gambia  
43. Senegal

48. Nigeria  
49. Guinea  
40. Burkina Faso  
42. Guinea-Bissau

43. Mali  
43. Mauritania

44. Sierra Leone  
44. Liberia  
44. Ivory Coast  
44. Ghana

44. Nigeria  
44. Mali  
44. Mauritania

44. Algeria  
44. Morocco  
44. Western Sahara

44. Spain  
44. Portugal  
44. France  
44. United Kingdom  
44. Ireland  
44. Germany  
44. Norway  
44. Iceland

44. Congo



**Mundo árabe:** Las mujeres sostienen una economía de cuidados en medio de enormes conflictos armados, y supervisan en sus comunidades la asistencia en salud, alimentos, cobijo y educación.

**Arab World:** Women maintain a care economy in the middle of massive armed conflicts and supervise health, nutrition, shelter, and educational assistance in their communities.



- 44. Ecuador
- 45. Panama
- 46. Costa Rica
- 47. El Salvador
- 48. Guatemala
- 49. Honduras
- 50. Belize



**Mesoamérica:** Las mujeres se enfrentan a los tratados de libre comercio, a la expansión de conflictos armados y al maíz transgénico, y protegen la diversidad de especies existentes.

**Central America:** Women stand against free trade agreements, the spread of armed conflicts, and genetically modified maize, and protect the diversity of the living species.

### Éxodo rural y represión

El sistema alimentario agroindustrial, basado en monocultivos y dominado por trasnacionales, alimenta a un 30% de la población mundial, y emplea en condiciones miserables a una infima parte de los trabajadores rurales. Destruye el medio ambiente, empobrece y expulsa a los pobladores originarios, mientras se expande a través de la militarización y la represión, generando la pérdida de los derechos colectivos sobre los bienes naturales, y transformando lo común en propiedad privada.

### Rural exodus and repression

The agro-industrial food system, based on monoculture and dominated by multinational firms, feeds 30% of the world population and employs—in appalling conditions—a minuscule portion of rural workers. It destroys the environment, impoverishes and drives out native populations, and thrives through militarisation and repression—thus causing the loss of collective rights over natural assets and turning public goods into private property.

### Soberanía alimentaria y cultural

Las mujeres rurales, mediante prácticas de defensa de los bienes comunes, de protección de la cultura popular y solidaria, y de respeto hacia la naturaleza; aseguran la agrobiodiversidad frente al avance del despojo neocolonial. Custodian, además, las más de 6 mil lenguas vivas en todo el mundo, cada una desarrollada durante siglos de costumbres y portadoras de tradiciones y prácticas riquísimas, mayormente desconocidas, lo que las convierte en guardianas de las memorias de la tierra.

### Food and cultural sovereignty

Through practices that defend public goods, protect shared traditional culture, and respect nature, rural women ensure agricultural diversity in the face of neocolonial dispossession. They are also guardians of the over 6000 languages spoken across the world, which developed over the centuries, bear rich traditions, and are mostly unknown. As a result, these women are the keepers of the memories of the Earth.

# Counter-Cartographies

## Politics, Art and the Insurrection of Maps

André Mesquita

[andremesquita.redezero.org](http://andremesquita.redezero.org)

Tracing out complex systems. Comprehending conflicts, networks, territories, borders and situations which were previously invisible. Sharing techniques and new technologies. Producing autonomous knowledge. These are some of the strategies that characterize the practices of critical cartography. Up to which point do these maps succeed in going beyond conventional maps, opposing impartial representations and objectives followed by corporative, military and governmental interests? In which way can arts and activism employed by cartographers and insurgent artists contest these dominant powers? What are the possibilities for participating in these movements?

We might be used to thinking that maps are exact representations of reality. But neither does neutrality exist in the production of maps nor does it exist in their use. In the hands of capitalism and its institutions, mappings have been instrumentalized in many ways: for installing order and executing domination of colonizers over the colonized, for consolidating economic blocks, for justifying private control over public spaces, for legitimizing borders, for exploiting natural resources and common goods. Yet the proposition I want to discuss here is the following: parting from their history as instruments of domination, maps can also be transformed and thus used by the hands of those who resist state control and capitalist domination. This transformation becomes possible due to the fact that cartography – as the discipline of the creation of maps as well as the study and reflection of their political and social role – suffered from a substantial change in the twentieth century, in that it was and still continues to be widely subverted by artists and activists. This contribution elaborates on some examples of artists and collectives that promoted this change. I will explore their struggles to position themselves in the capitalist art world and point out the renewed relevance of counter-cartographies.

The resistance against capital's cooptation of culture calls for the production of new radical imaginaries, spaces of political autonomy and shared invention. This is also the case for the regulation of the forces of cooperation which tend to be captured, absorbed, and neutralized by corporative, military and commercial mechanisms. It also calls for the elaboration of conceptual and analytical tools that enable the visualization of the ever more sophisticated structures of capitalism which provoke new situations of opposition and political engagement. Mappings realized by collectives of art activism – such as the Bureau d'Études (France)<sup>1</sup>, the Counter-Cartographies Collective (United States)<sup>2</sup> (see article page 212), Iconoclastas (Argentina)<sup>3</sup> (see articles pages 86 & 183) and many others presented in *Not-an-Atlas* – are examples of open and process-oriented tools proposing to map regional and global

flows of power systems, monopolies and administrative networks. The maps of these collectives give us an idea about which forms of counter-power we need to create and what social struggles are, as they are much more than mere representations. In order to create counter-cartographies, their practices invert sovereignty of a cartography of control. And, in fact, these maps can also be seen as starting points for subversive actions.

### Making Domination Visible

In this contribution counter-cartographies are understood as maps that break with the scientific tradition and specialization of cartography as well as with its mere technical or essentially positivist view of the world. This type of transgression goes against official geopolitical maps while exposing relations of domination over and exploitation of a territory as well as revealing concealed networks of power. With an anti-capitalist orientation, one of the aims of counter-maps is to make obscure and established powers more perceptible in order to confront them. Counter-cartographies can be used in a tactical manner over the duration of an action and in a strategical manner for analyzing networks and spaces in order to generate social change from below. Another task is to deconstruct the political and economic logics of mechanisms, organizations and social hierarchies so as to reveal its contradictions. This type of experiment also makes arts political, not only due to the approach of a "political issue", but because its sensitive and intuitive expression is capable of enunciating the violence going on behind the scenes.

Articulations between artistic practices, pedagogic alternatives and militant investigations make it possible to formulate questions concerning the experiences of counter-cartographies in relation to protocols and dilemmas of collaborative work. While mapping with communities and social movements, the artists/collectives mediate a continuous process in which the act of listening, the systematization of data as well as decisions regarding the means to make the maps are constructed, negotiated and decided upon collectively. Through collective mapping, the language, tools and techniques of cartography formerly restricted to "specialists", are socialized and reinvented. They are shared freely and thus expanded to non-conventional uses.

The transformation of cartography by practices of art activism over the past decades has made it possible to explore alternative models outside of the academic context and beyond purely scientific activities. This includes historical references going back to artistic vanguards at the beginning of the twentieth century (such as

Dadaism and Surrealism) as well as maps created by Situationists<sup>4</sup>, feminist artists and groups such as Fluxus.<sup>5</sup> One of these artists to anticipate some of the nuances of the political practices of counter-cartographies was the Swedish-Brazilian Öyvind Fahlström (1928-1976). He brought forward the critical necessity and revolutionary urgency for prefiguring another world as possible. This was done by challenging the rigidity of maps which portrayed a planet dominated by the instability of imperial power disputed between the United States and the Soviet Union.

With his World Map (1972), Fahlström confronted established limits and dominant powers individually in order to construct a counter-cartography as a tool for political sensitization and public indignation. The synoptic view of the World Map in a collection of events and in the narration of short chronicles shows the progression of political and economic power of North American imperialism during the Cold War, from the end of World War II to the beginning of the 1970's. Fahlström collected and organized data referring to different scales of analysis on the global economic situation, on exploitation, repression and struggles in the so-called "Third World". Statistics, thoughts, extracted texts and periodicals of the left as well as historical facts were compiled, registered on color-coded sheets and inserted into the continents of the World Map.

The world that pulsates, expands and contracts itself in the World Map does not register an exact mapping of the physical geography of the planet. Rather it is the quantity of information that shapes the forms of the continents in accordance with the

intensity of their crises. Its topographic malleability suppresses, transforms and recreates institutionalized borders in order to make space for fragments of stories. Oceans were practically abolished and are more narrow now. Like cracks they are swallowed by the collision of territories. The de-naturalized forms of the continents portrayed in the World Map try to support the weight of the facts describing a planet taken by greed and violence.

Another example of how counter-cartographies of artists can illuminate common territories between past and present which are generally hidden by official cartography, are the "narrative structures" built by Mark Lombardi (1951-2000) (see map this page).<sup>6</sup> In 1994, Lombardi decided to give a new direction to his art work by systematizing the practice of an archivist obsessed with documenting a continuous flow of information on political, economic and corporative powers.

Lombardi shows us data and connections in a network of trajectories, designed in the form of circles and arcs that take up great spaces on paper. We find appointed identities in the names of institutions, presidents, bankers, mafia bosses, terrorists and soldiers cited within small circles

that make us remember their polemical stories once shown in the media. We are taken by a disconcerting reality seeing individuals connected to wars, drug trafficking and crimes. An interlaced swarming of the financial and corporative world emerges with multiple causalities. Exorbitant numbers link individuals and companies through dashed lines.

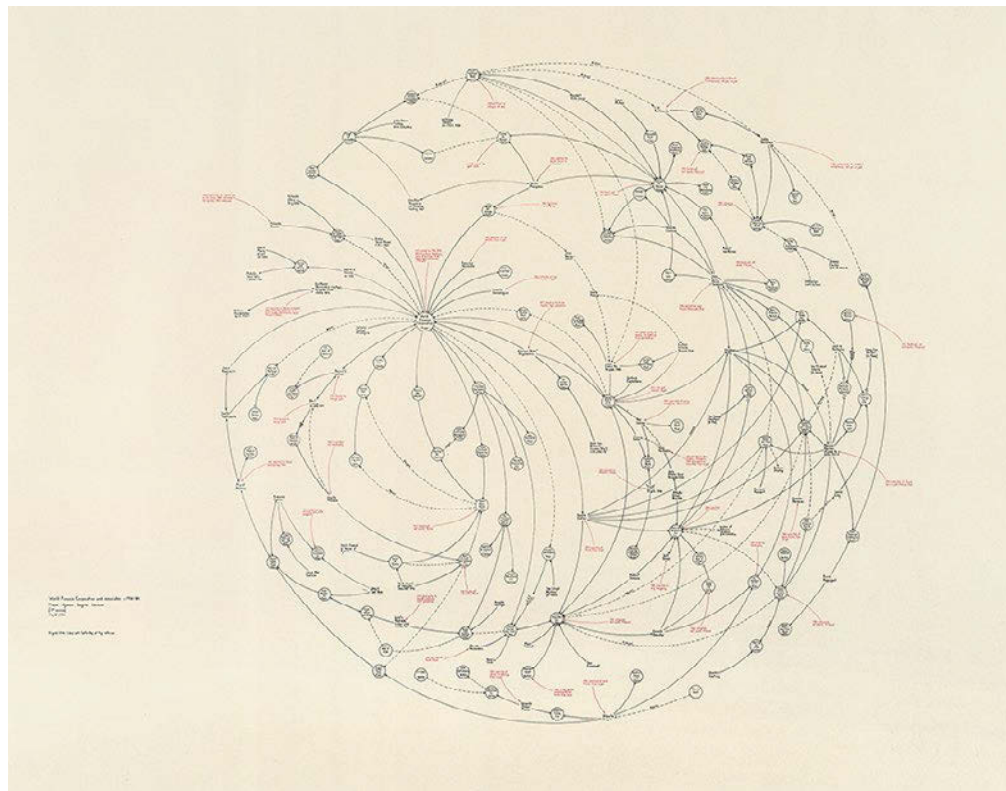

Fahlström's maps were elaborated in the troubled moments of the 1970s, while Lombardi configured narrative structures during the exponential development of global and financial networks two decades later. Both are important historical and conceptual precedents for a posterior generation of artist-activists. Fahlström and Lombardi worked with particular methods to manually compile and archive precise and verifiable data on political, social and economic processes, organizing it in maps or diagrams to analyze situations of the present. Evidently, the work of these two artists has gradually been incorporated into the permanent archives of museums, banks, galleries and collectors. As museums, collectors and companies have turned into the contemporary guardians of these artistic cartographies that reveal the access to power, the access to these works is even more restricted.

### Use Value and Artistic Autonomy

It is necessary to point out some escape strategies that mark the history of artistic cartography. In the essay "Resymbolizing Machines: art after Öyvind Fahlström" the Bureau d'Études (2004) examines how Fahlström tried to gradually leave art institutions and gained relative autonomy through a system of alternative distributions of his maps and games. A version of the World Map [Sketch for World Map Part I (Americas, Pacific)] was printed, and distributed through a new left journal of the seventies [Liberated Guardian] to disseminate the political content of this work and reach a wider public (Bureau d'Études, 2004).

The Bureau d'Études uses Fahlström as a reference to examine failures and advances of artists when their projects depend on the authority and the discourses of the art world. For example, this may include the endorsement of curators, critics, collectors, etc. to be legitimized or even suppressed when trying to leave this system. Investigations by the Counter-Cartographies Collective also show that, at present, when companies, institutions and clusters of so-called "creative industries" capture the power of inventions of students and cultural workers, a trend to exclude these groups from the networks of production must be observed. At the same time there is an enormous distrust concerning the forms of expression that circulate via official channels – may those channels be museums, governments, universities, marketing agencies or media conglomerates.

By conducting interviews and workshops with students, the Counter-Cartographies Collective produced a DisOrientation Guide (2006, 2009) (see map on opposite page) on the campus of its University of North Carolina, localized in the "Research Triangle" formed by the cities of Durham, Raleigh and Chapel Hill. The guide shows diverse maps and diagrams connecting student struggles in their institutions with demonstrations that have occurred in other countries. The Counter-Cartographies Collective considers that universities are not a "privileged bubble", an "isolated space" or an "ivory tower" separated from the world but rather a fabric that concentrates flexible work markets, knowledge economies, corporative research, financial capitalism and gentrification. In these initiatives of counter-mapping lies a necessity to seek not a romanticized redemption of an autonomy from society or a repetition of gestures or formulas, that, in the best case, will be considered as acts of institutional critique. Rather they call for

the reformulation of this criticism to other disciplines regulated by neoliberalism in the face of the production of spaces of artistic autonomy.

In its most basic sense, autonomy signifies "self-legislation". It is the capacity of a group, of an occupation or community to establish its proper institutions and to self-organize according to its agreements. The term artistic autonomy, fundamental for the Bureau d'Études, indicates the decision of aesthetic producers to restructure themselves in order to seek new ways of acting, prioritizing alternative experiences of publication, reception and distribution. In this sense, the maps of the Bureau d'Études (see map at the end of the article) problematize in detail and exhaustively the almost inaccessible links between institutions as well as known and unknown individuals. In order to do so, they start with mapping the power concentration of corporate media, the system of food production, global vigilance, military technologies, prisons, financial networks and economic crises among other topics. For this collective autonomy is a fundamental point of their existence. They thus seek to visualize the lines of production and the resulting meanings of official systems through their maps. It is necessary to decode the capitalist machinery in order to intervene in it, and to thereby situate insurgent strategies and actions.

In the beginning of the 2000s, the maps of the Bureau d'Études began to serve the group as a means to orient themselves in reference to networks of control which needed to be surpassed as well as political autonomy which needed to be created. The protests of the Global Days of Action and the use of technological networks by artists and social movements delineated a new topology of the planet that needed to be understood and situated. Even more so, since after September 11, 2001, the disproportional increase of intelligence services and private companies exploring programs of vigilance and monitoring channels of communication needed to be verified. The internet opened up countless possibilities to conduct critical mapping investigations of contemporary capitalism. For these investigations the map productions and the new cognitive tools have become essential to close a gap regarding the means of analysis. This approximates them to demonstrations and other forms of direct action.

Artistic autonomy crosses habitual dichotomies of inside/outside of art institutions. The question to be answered by collectives of art activism continues to be the following: how can the subordination under official institutional models be escaped and a way of non-mediated autonomy be found? In other words, how do counter-cartographies find a political space in which to formulate their compositions of this "outside"?

While a diagram such as Lombardi's is a unique work of art, the works of collectives of counter-cartographies are produced and shared like common goods in order to deepen knowledge, to inform, to inspire and to be engaged with. An example of these dynamics can be found in the works of the Iconoclasistas. Formed in Buenos Aires in 2006, the Iconoclasistas have since then combined theoretical research and graphic arts in mapping workshops with students and social movements (see second map at the end of the previous article).

For Maribel Casas-Cortés and Sebastian Cobarrubias, members of the Counter-Cartographies Collective, maps become more heterogeneous when they are produced in a collective way.

# FORECAST: NEW WAVES OF AUTONOMY



**AMERICA LATINA:** Autonomous universities, independent from the state and corporate powers, include Universidad de la Tierra in Oaxaca and Chiapas, Mexico (two separate institutions), Universidad Experimental in Rosario, Argentina, and Universidad Libre in Chile. Recent struggles include protests against tuition at the national university in Mexico City, the occupation of university land to construct a new student center at the UBA in Buenos Aires, and (pictured) a 30-day student and faculty strike in solidarity with striking workers at Brazil's largest university, the Universidade de Sao Paulo.

As 3Cs we participate in a growing network of students, faculty, and staff fighting for autonomy on university campuses around the world. Other members of this network helped create this work in progress by submitting current struggles (⚡) and autonomous universities (☀️), as well as participants in the series of 'Edu-Factory' discussions (☁️). This map is not complete. Visit [countercartographies.org](http://countercartographies.org) to help add to the map and find out more details!



**AFRICA:** Students in Liberia (pictured), Sierra Leone, Egypt and Morocco, along with South Africa, participated in the 2008-2009 Global Weeks of Action against commercialization of education through teach-ins, seminars, and rallies. Students also protest for better facilities and more autonomy from repressive and/or neoliberal governments. South African scholars in Durban and Johannesburg participate in the Edu-Factory discussions.



**AUSTRALIA:** The Australian higher education system is in crisis due to the recent sharp upswing in the number of international students. Indian students and graduates are driven to service work, often taxi driving, and face growing discrimination and violence. Indian cab drivers go on strike multiple times in large cities, including Sydney and Melbourne, to protest their situation. Students and faculty at other universities protest against the commercialization of education and participated in the Global Week of Action and the Edu-Factory project.



**NORTH AMERICA:** Increasingly precarious TA and adjunct faculty work is a major site of struggle, with contingent faculty unionization efforts and strikes in Toronto, Minnesota, Michigan, Oregon, and elsewhere. As the economic crisis is used to justify increasing corporatization of the university, students answer by occupying buildings at the New School (pictured) and NYU. After a for-profit governing board shuts down Antioch College, students and teachers open their own autonomous Nonstop Institute for the Liberal Arts, building their infrastructure from the ground up. International conferences on Rethinking and Reworking the University 2008 and 2009 galvanize critical thought on the university.



**EUROPE:** School occupations in Spain and the UK, massive student strikes in Italy, university riots in Greece. New university policies, known throughout the EU as the Bologna process, are met with the Anomalous Wave – a massive response on the part of students, professors and staff. This Wave is more than street confrontations with police; it strengthens 'autonomous universities', where student and faculty-run higher education and research includes their own decision making processes and curricula. The regular university system collaborates with autonomous universities across the EU and as far east as the Street University in St. Petersburg.



**ASIA:** University students across Asia link their struggles for better and more affordable education to campaigns for more democratic governments. Students in Singapore protest university censorship. Students in Taiwan protest the Parade and Assembly law. In the Philippines, students strip down and protest naked against tuition hikes. Autonomous universities and edu-factory participants in the region include: the Vidya Ashram in India, and student groups in Shanghai, Taiwan, and Delhi.



Through collective processes they create instances for popular participation, its information and icons can be added more easily, and other people can suggest different relevant data for the map. This data may include information about a specific corporation or a set of work relations, and it often enables the development of new aesthetics of cognitive mapping as well as the discussion of new issues to be mapped (see Casas-Cortés and Cobarrubias, 2007, p. 120). Collaboration and cooperation increase the complexity of the power and critical grasp of a map based upon different perceptions. Counter-cartographies are an essential element of the repertory of the forms of artistic activism. They are one tool within a variety of tactical actions and artistic interventions carried out in public space, each corresponding to specific situations. Regarding the circulation and multiplication of their maps, the Iconoclastas, the Bureau d'Études and the Counter-Cartographies Collective count on electronic distribution of their projects

on web pages, blogs and digital communities. Printed versions can be paid for with the budget of an exhibition or with money from one's own pocket. This enables the map's circulation in autonomous spaces, schools, workshops, open classes and activist meetings while being distributed for free and from hand to hand. All this permits immediate, open and unlimited public access to these works, ascribing them a use value that cannot be achieved through a circulation which is restricted to the spaces of galleries and museums.

Through these maps a new sense is conferred to cartography. Cartography is not only a particularized activity or a restricted knowledge but can also be seen as a possible project that disseminates as much as possible – a type of information which was usually related to a specific public and specific sources. These maps result from an effort of collective intelligence offering free knowledge to any person interested in researching them in order

to initiate their own investigations. They represent practices that point to the fact that the moment has come to rethink the means of production and the emergence of a political counter-history of arts and culture (Sholette, 2011, p. 3). The work with counter-cartographies does not only reveal systems of power as it gives a new sense to the notion of "maps producing territory". Moreover, this territory produced by the map is multiple, not only spatial, but also temporal and social: it extends from the place where the maps are produced – with its stories, reports and vestiges – to the countless situations in which they are distributed, accessed and used.

### Mapping or Being Mapped

The politicized appropriation of the mapping practices by artist-activists in the last decades has helped to transform cartography into a tool of criticism and counter-power. Nevertheless, we live in a totally mapped era in which our expectations, gestures and itineraries are registered all the time, be it while circulating in the streets, exchanging messages and documents via the internet, or crossing physical or symbolic borders. Why then produce more maps in a mapped world? My response is that we need to make and remake maps not only in order to confront the forms of control but also so we can expose the underlying mechanisms. Most of all we need to produce counter-maps in order to create actions that might affect our perceptions of social space and its different vectors, to change our modes of looking at the world and create new dialogues and discoveries. Counter-cartography is less a visual object that accumulates information than the opportunity to go beyond the "proper" representation of traditional maps. Mapping in a different way means redefining maps critically. This redefinition of cartography is an expression of dissent against the power executed by privileged groups who seek to dominate others. At the same time, it is an opportunity to democratize the techniques and the practices of the creation of maps beyond the figure of the artist, activist or specialist. A statement cited from an interview I did with the members of the Counter-Cartography Collective seems to summarize the spirit of this proposal in other words: "To map systems of oppression, not oppressed people!"

*Special thanks to Julia Ruiz Di Giovanni for her help with the editing of this text.*

*Translation by Timo Bartholl*

### Endnotes

1. [bureaudetudes.org](http://bureaudetudes.org)
2. [countercartographies.org](http://countercartographies.org)
3. [iconoclastistas.net](http://iconoclastistas.net)
4. The Situationist International (1957-1972) was an organization of artists and theorists searching for ways to criticize and transform the conditions in capitalist cities while superating the concept of art through subversive everyday practices and artistic interventions.
5. Fluxus was an international, multidisciplinary group of artists, poets and composers initiated in the early 1960s. The group realized works, performances and artistic projects with an emphasis on processes and actions that encouraged the active participation of its spectators.
6. Mark Lombardi describes his "narrative structures" as follows: "In 1994 I began a series of drawings I refer to as 'narrative structures.' Most were executed in graphite or pen and ink on paper. Some are quite large, measuring up to 5x12 feet. I call them 'narrative structures' because each consists of a network of lines and notations that are meant to convey a story, typically a recent event of interest to me, like the collapse of a large international bank, trading company, or investment house. One of my goals is to explore the interaction of political, social, and economic forces in contemporary affairs." (Lombardi, 2001).

### References

- Bureau d'Études 2004. *Resymbolising Machines: Art after Öyvind Fahlström. Third Text*, 18: 609-616.
- Casas-Cortés, M. & Cobarrubias, S. 2007. Drifting Through the Knowledge Machine. In Shukaitis, S. & Graeber, D., eds. *Constituent Imagination: Militant Investigations // Collective Theorization*. Oakland: AK Press: 112-126. [countercartographies.org/download/driftng\\_through\\_the\\_knowledge\\_machine.pdf](http://countercartographies.org/download/driftng_through_the_knowledge_machine.pdf), 14 January 2018.
- Lombardi, M. 2001. The Recent Drawings: An Overview. *Cabinet Mag.* [cabinetmagazine.org/issues/2/lombardi.php](http://cabinetmagazine.org/issues/2/lombardi.php), 29 June 2018.
- Sholette, G. 2011. *Dark matter: art and politics in the age of enterprise culture, Marxism and culture*. New York: PlutoPress.

### Illustrations

- page 27 Mark Lombardi, World Finance Corporation and Associates, c. 1970-84, Miami, Ajman, Bogota-Caracas (Brigada 2506 : Cuban Anti-Castro Bay of Pigs Veteran) (7th version), 1999, Colored pencil and graphite on paper, 69 1/8 x 84 inches, Private collection, Courtesy Donald Lombardi and Pierogi Gallery
- page 29 Counter Cartographies Collective, disOrientation Guide 2.0, 2009
- page 35-39 Bureau d'Études, World Government, 2013, Courtesy Bureau d'Études



# Pictographic Grammar



## Organizations

### Public organizations and services

**UNITED STATES** State  
**CITY (LONDON)** Tax haven  
**European Commission** Regional Union  
**G30** Council  
**EPO** Regional organisation  
**NATO** International governmental organisation  
**SEC** Authority or regulation body  
**OFS** Commission or office  
**NNWC** Commandment body  
**MIT** Secret service  
**PSC** Committee  
**Euroclear** International Central securities depository (CSD)  
**JASDEC** central Clearing house  
**LCH** Sources of market data  
**ISDA** International Public bank  
**ADB** Central bank  
**BCE**  
**Berkman Kleinman** Laboratory  
**IAOS** international Research Center  
**DLR** national  
**Yale** High school for business & administration

### Social organizations

**IIF** pressure group (lobby)  
**IHEU** International religious or philosophical interest group  
**IUBMB** International research interest organization  
**WET** International Religious Organisation  
**Greenpeace** International Voluntary Organisation  
**W3C** International non governmental & non for-profit Organisation (NGO)  
**NETS** Forum, network  
**WSF** International Forum  
**Fair Trade** Movement  
**uk ISS** Think tank  
**Order of Malta** Order  
**PCF** national Political party  
**Davos** Clubs  
**Secret society**  
**Global Greens** international

## Companies

**jap** Headquarter in Japan  
**uk** Headquarter in an imperialist state of the XIXth century  
**2** World rank  
**swf** sovereign wealth funds  
**Collaboration with oppressive regimes**  
**Slave or forced labour**  
**Human experiments**  
**2008** Fraud  
**2008** Confirmed Price Manipulation  
**Sinar Mas Group** Conglomerate  
**Pension Fund of Norway** Pension fund  
**Goldman Sachs** Financial company  
**Lex Mundi** Firm network  
**FannieMae** Public Company  
**Nova Scotia** Company  
**Production and distribution companies**  
 Nuclear power, Computer & semi-conductors, Telecom, Distribution, Agro-industry & agro-food, Information services & internet, Chemical Pharma, Energy, Shipbuilding, Mining & commodities, Space development, Engineering, Meat production, Weapons  
**Producing desire and consentment companies**  
 Music, Mercenaries, Law firms, Game and toy, Media, Manipulation of the public sphere, Entertainment, Lobbying firm, Private intelligence  
**Bank, trade and market companies**  
 Inspection & certification services, Broker-dealer, Buyers of debt, Electronic trading system, Land dealer, Trading companies, Banks, Clearing company, Rating agencies

## Technical & symbolic systems and devices

**Finance**  
**payment systems**  
**TARGET2** Real-time payment processing system or funds transfer system  
**SIPS** Payment systems which have the characteristic that a failure of these systems could potentially endanger the operation of the whole economy.  
**Electronic platform**  
 An Electronic trading platform is a computer system that can be used to place orders for financial products over a network. Robots account for 60% to 70% of the volume on the major U.S. stock exchanges (www.kiplinger.com, 2011)  
**Dark pools**  
 Alternative electronic stock exchanges where trading takes place anonymously, with most orders hidden or "iceberged."  
**CDX** Index  
**Paydex** Score and ratio  
**Euribor** Rate  
**Shanghai Stock Exchange** Stock, bond exchanges  
**Juridical or normative devices**  
**EFTA** Free trade area  
**Schengen** Common visa policy area  
**Legal area**  
**Basel II** international  
**EFSM** european  
**TARP** american  
**Program, project, plan or mechanism**  
**Contract, accord, treaty, law, decree, pact, license...**  
**Other technoscientific devices**  
**Information network**  
**Megaproject**  
**Satellite and networks of satellites**  
**Synchrotron or particle collider**  
**Space explorer**  
**Super computer**  
**Reactor**  
**Alert system**  
**research area**  
**Army**  
**Early Warning System**  
**Nuclear missiles defense shields**  
**Satellite detection**  
**Military bases**  
**US Air Base with Nuclear Vaults**  
**Mass surveillance system**  
**Other data base**  
**Secret prison**  
**Deaths and wastes**  
**Food contamination**  
**Irak** killing fields  
**Capture/kill database**  
**radioactivity**  
**deforestation**  
**air pollution**  
**Massive destruction or pollution of nature**  
**genetic pollution**  
**water pollution**

# World government

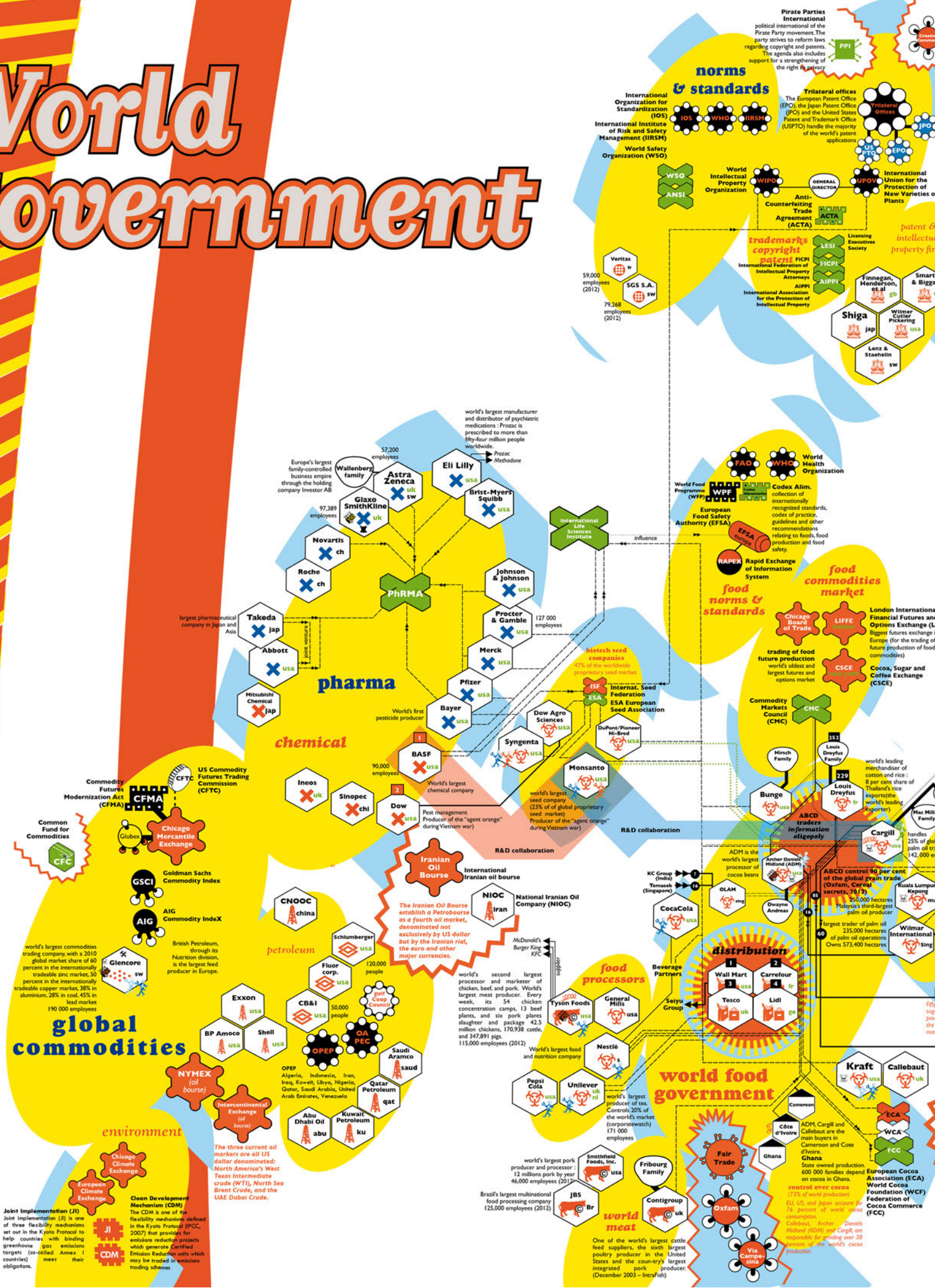

# World government

## norms & standards

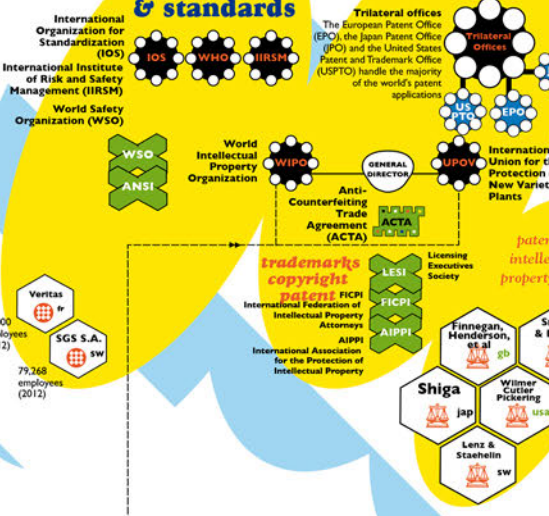

## pharma

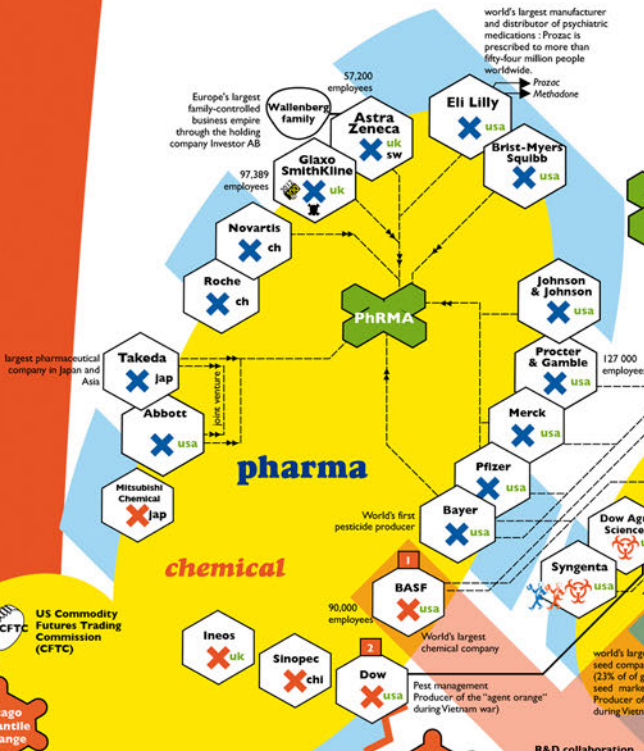

## chemical

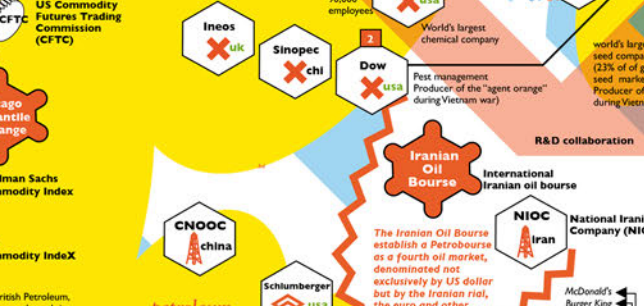

## global commodities



## food norms & standards

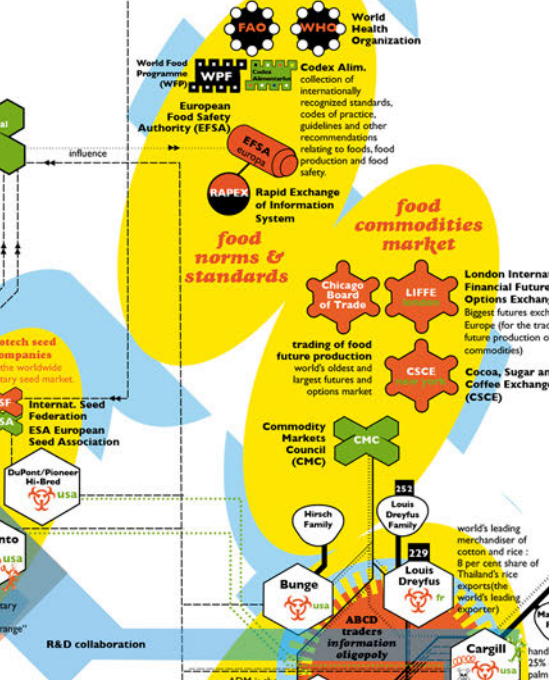

## food commodities market

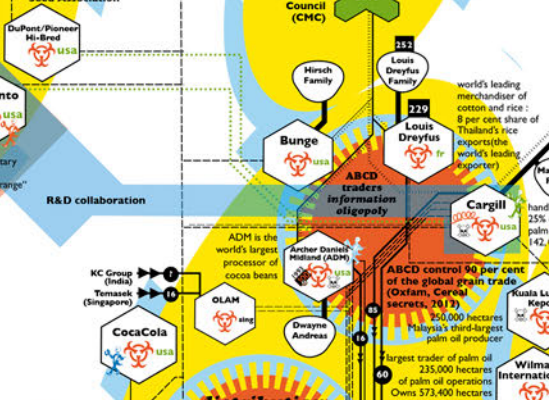

## distribution

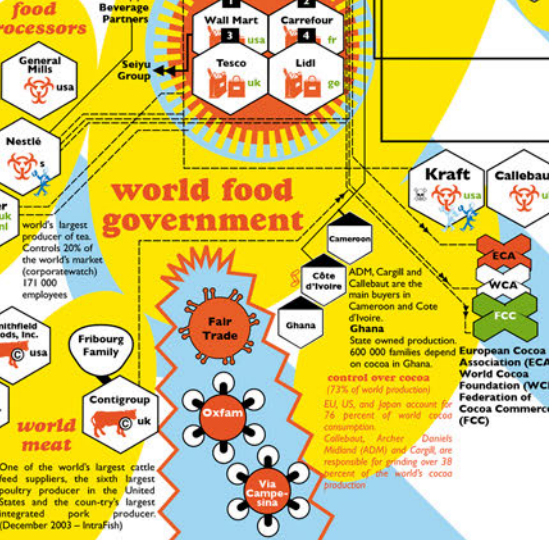

## world food government



## environment

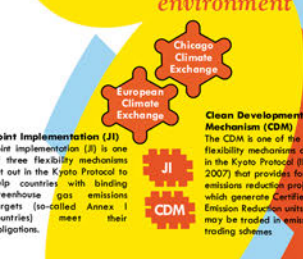

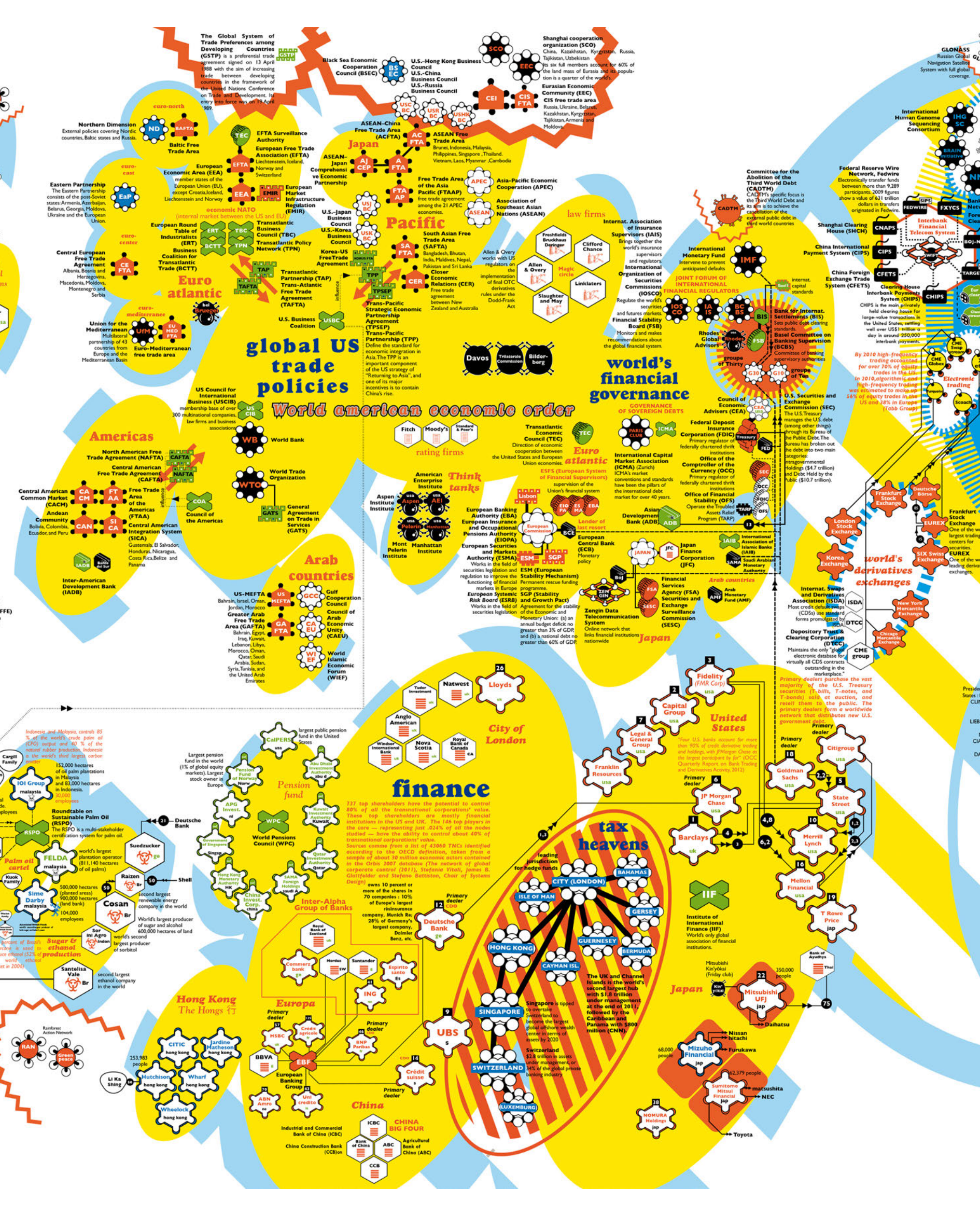

**The Global System of Trade Preferences among Developing Countries (GSTP)** is a preferential trade agreement signed on 13 April 1988 with the aim of increasing trade between developing countries in the framework of the United Nations Conference on Trade and Development. Its entry into force was on 19 April 1993.

**Shanghai cooperation organization (SCO)** China, Kazakhstan, Kyrgyzstan, Russia, Tajikistan, Uzbekistan. Its six full members account for 60% of the land mass of Eurasia and its population is a quarter of the world's.

**Eastern Partnership** The Eastern Partnership consists of the post-Soviet states: Armenia, Azerbaijan, Belarus, Georgia, Moldova, Ukraine and the European Union.

**ASEAN Free Trade Area (AFTA)** Brunei, Indonesia, Malaysia, Philippines, Singapore, Thailand, Vietnam, Laos, Myanmar, Cambodia.

**Asia-Pacific Economic Cooperation (APEC)** Define the standard for economic integration in Asia. The TPP is an important component of the US strategy of "Returning to Asia", and one of its major incentives is to contain China's rise.

**International Monetary Fund (IMF)** Sets public debt clearing standards. The bureau has broken out the debt into two main categories: intragovernmental holding (\$4.7 trillion) and Debt Held by the Public (\$10.7 trillion).

**China Foreign Exchange Trade System (CFETS)** CHIPS is the main privately held clearing house for large-value transactions in the United States, settling well over US\$1 trillion a day in around 200,000 interbank payments.

# global US trade policies

# World american economic order

# world's financial governance

**Americas**  
 North American Free Trade Agreement (NAFTA)  
 Central American Free Trade Agreement (CAFTA)  
 Central American Common Market (CACM)  
 Community Andean  
 Inter-American Development Bank (IADB)

**Arab countries**  
 US-MEFTA  
 GCC  
 Gulf Cooperation Council  
 Council of Arab Economic Unity (CAEU)  
 World Islamic Economic Forum (WIEF)

**Europe**  
 European Union (EU)  
 European Free Trade Association (EFTA)  
 Transatlantic Partnership (TAP)  
 Transatlantic Free Trade Agreement (TAFTA)

**World's derivatives exchanges**  
 London Stock Exchange  
 Frankfurt Stock Exchange  
 New York Mercantile Exchange  
 Chicago Stock Exchange  
 CME Group

**World Bank**  
 World Trade Organization  
 US Council for International Business (USCIB)  
 World Bank

**Think tanks**  
 American Enterprise Institute  
 Aspen Institute  
 Mont Manhattan Institute  
 Heritage Foundation

**Japan**  
 Japanese Financial Services Agency (FSA)  
 Japan Finance Securities Corporation (JFSC)  
 Financial Services Agency (FSA)  
 Securities and Exchange Surveillance Commission (SESC)

**United States**  
 Fidelity (FMR Corp)  
 Capital Group  
 Franklin Resources  
 JP Morgan Chase  
 Barclays

**City of London**  
 Natwest  
 Lloyds  
 Anglo American  
 Nova Scotia  
 Royal Bank of Canada

**Finance**  
 Largest pension fund in the United States  
 Largest pension fund in the world (1% of global equity markets)  
 Largest stock owner in Europe

**United States**  
 Fidelity (FMR Corp)  
 Capital Group  
 Franklin Resources  
 JP Morgan Chase  
 Barclays

**United States**  
 Fidelity (FMR Corp)  
 Capital Group  
 Franklin Resources  
 JP Morgan Chase  
 Barclays

**Europe**  
 Deutsche Bank  
 World Pensions Council (WPC)

**tax heavens**  
 City of London  
 Isle of Man  
 Jersey  
 Guernsey  
 Bermuda  
 Cayman Is.  
 Singapore  
 Switzerland

**United States**  
 Fidelity (FMR Corp)  
 Capital Group  
 Franklin Resources  
 JP Morgan Chase  
 Barclays

**United States**  
 Fidelity (FMR Corp)  
 Capital Group  
 Franklin Resources  
 JP Morgan Chase  
 Barclays

**China**  
 Industrial and Commercial Bank of China (ICBC)  
 China Construction Bank (CCB)  
 Bank of China (ABC)  
 Agricultural Bank of China (ABC)

**Europe**  
 Deutsche Bank  
 HSBC  
 BNP Paribas  
 Credit Suisse

**Japan**  
 Mitsubishi UFJ  
 Daihatsu  
 Furuwaka  
 Matsushita  
 Toyota

**United States**  
 Fidelity (FMR Corp)  
 Capital Group  
 Franklin Resources  
 JP Morgan Chase  
 Barclays

**Hong Kong**  
 The Hongkong & Shanghai Banking Corporation (HSBC)  
 Citic Hong Kong  
 Jardine Matheson  
 Hutchison  
 Wharfedale  
 Wheelock

**tax heavens**  
 City of London  
 Isle of Man  
 Jersey  
 Guernsey  
 Bermuda  
 Cayman Is.  
 Singapore  
 Switzerland

**United States**  
 Fidelity (FMR Corp)  
 Capital Group  
 Franklin Resources  
 JP Morgan Chase  
 Barclays

**United States**  
 Fidelity (FMR Corp)  
 Capital Group  
 Franklin Resources  
 JP Morgan Chase  
 Barclays

**China**  
 Industrial and Commercial Bank of China (ICBC)  
 China Construction Bank (CCB)  
 Bank of China (ABC)  
 Agricultural Bank of China (ABC)

**Europe**  
 Deutsche Bank  
 HSBC  
 BNP Paribas  
 Credit Suisse

**Japan**  
 Mitsubishi UFJ  
 Daihatsu  
 Furuwaka  
 Matsushita  
 Toyota

**United States**  
 Fidelity (FMR Corp)  
 Capital Group  
 Franklin Resources  
 JP Morgan Chase  
 Barclays

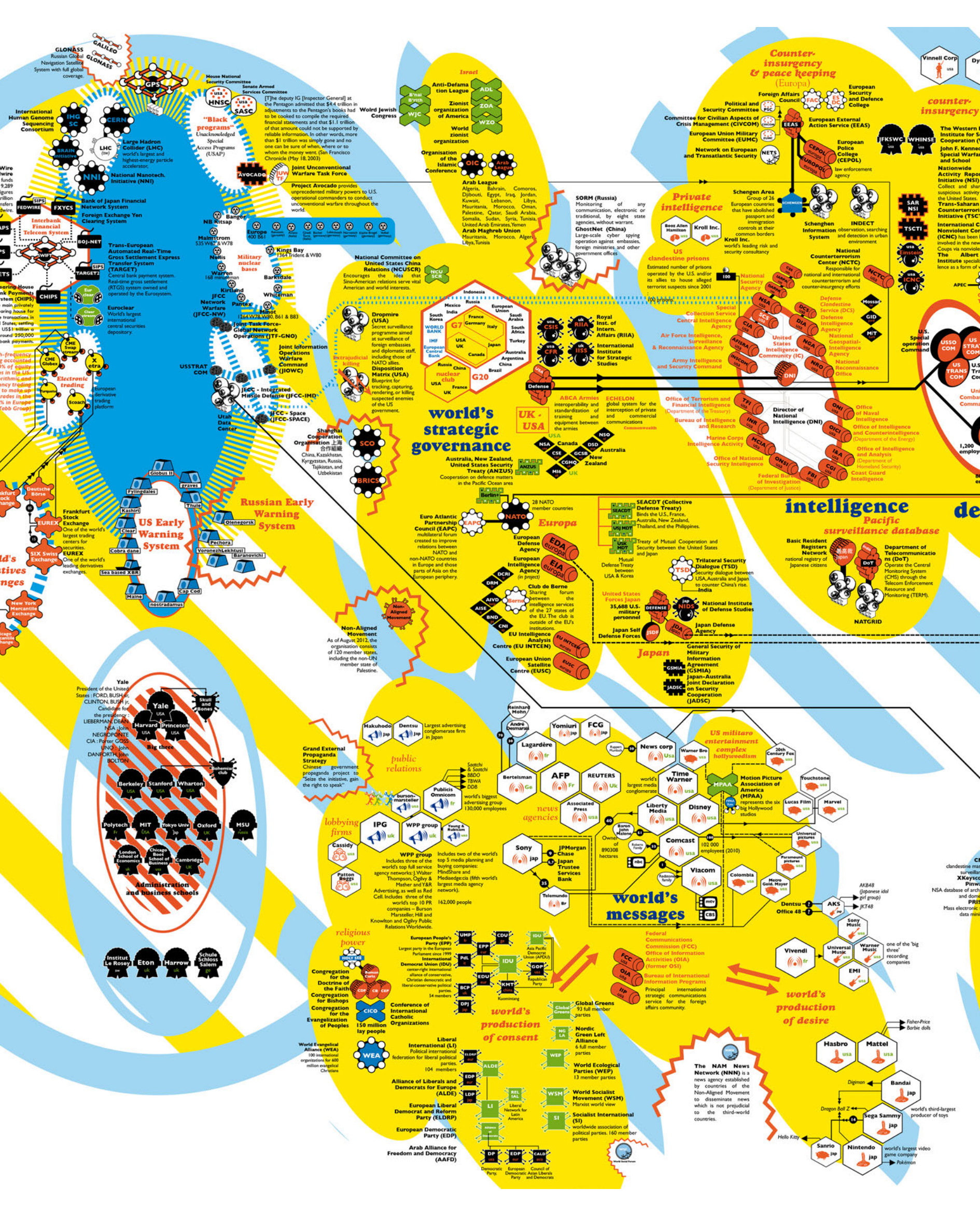

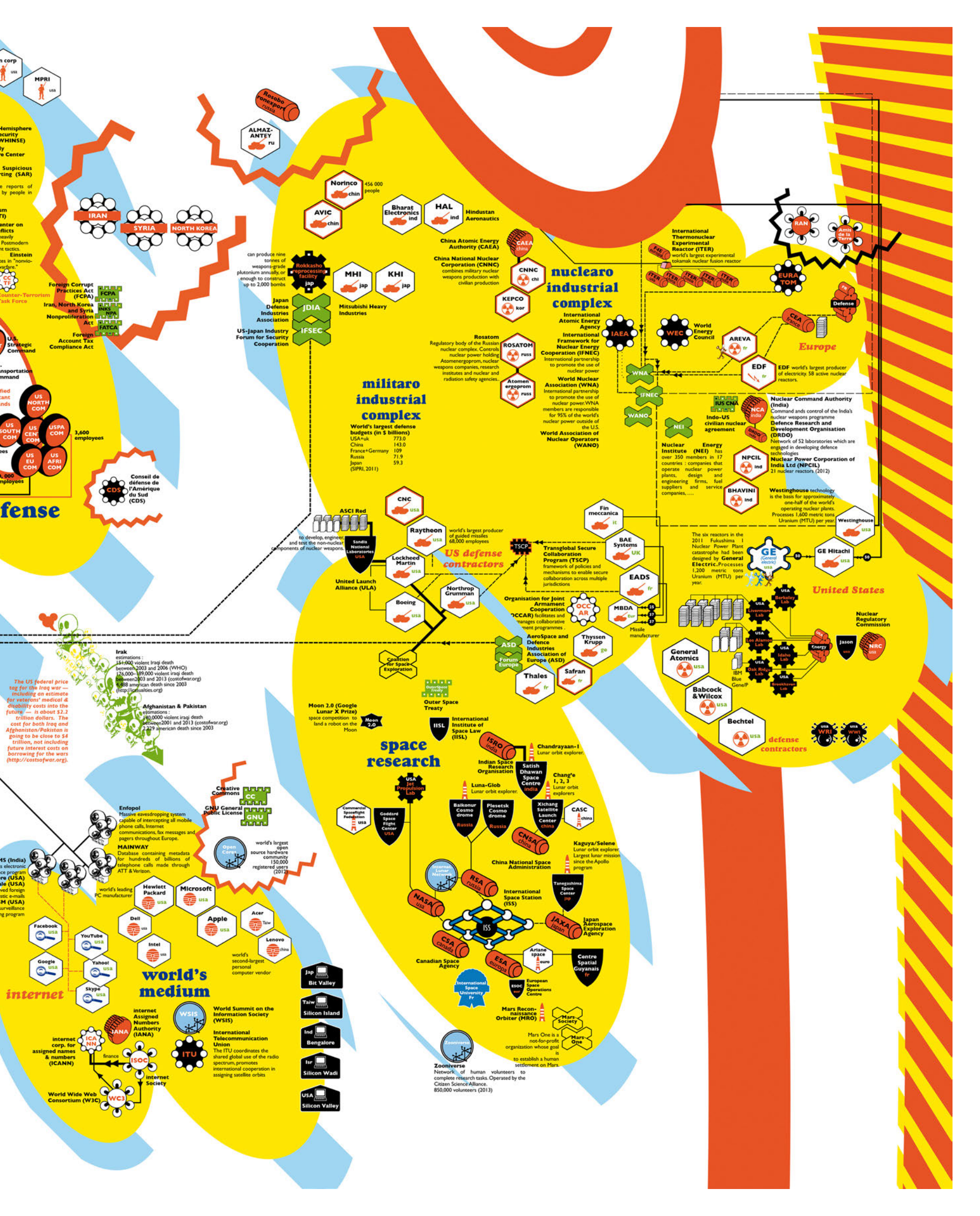

**defense**

- MPRI USA
- Hemisphere security (WHINSE)
- Suspicious (SAR)
- Foreign Corrupt Practices Act (FCPA)
- Foreign Account Tax Compliance Act
- US Strategic Command
- US NORTH COM
- US SOUTH COM
- US CENT COM
- US AFRI COM
- US EU COM
- 3,400 employees
- Conseil de défense de l'Amérique du Sud (CDS)

**militaro industrial complex**

World's largest defense budgets (in \$ billions)

USA	773.0
China	143.0
France + Germany	109
Russia	71.9
Japan	59.3

(SIPRI, 2011)

- ALMAZ-ANTEY RU
- Norinco CHN
- AVIC CHN
- Bharat Electronics IND
- HAL IND
- Hindustan Aeronautics
- China Atomic Energy Authority (CAEA)
- China National Nuclear Corporation (CNNC)
- Rosatom
- ROSATOM
- Atomenergoprom
- MHI JAP
- KHI JAP
- Mitsubishi Heavy Industries
- JDIA
- IFSEC
- Japan Defense Industries Association
- US-Japan Industry Forum for Security Cooperation

**nuclear industrial complex**

International Atomic Energy Agency (IAEA)

International Framework for Nuclear Energy Cooperation (IFNEC)

World Nuclear Association (WNA)

World Association of Nuclear Operators (WANO)

WEC World Energy Council

AREVA

EDF

CEA France

Defense

International Thermonuclear Experimental Reactor (ITER)

WNA

IFNEC

WANO

NEI

Indo-US civilian nuclear agreement

Nuclear Command Authority (India)

Defence Research and Development Organisation (DRDO)

Nuclear Power Corporation of India Ltd (NPCIL)

BHAVINI

Westinghouse

General Atomics

Babcock & Wilcox

Bechtel

**United States**

Nuclear Regulatory Commission

GE Hitachi

General Atomics

Babcock & Wilcox

Bechtel

defense contractors

ASCI Red

Sandia National Laboratories

United Launch Alliance (ULA)

Boeing

Northrop Grumman

Lockheed Martin

Raytheon

CNC

ASD

Forum Europe

Thales

Safran

Thyssen Krupp

MBDA

Finmeccanica

BAE Systems

EADS

TSCAP

Organisation for Joint Armament Cooperation (OCCAR)

AeroSpace and Defense Industries Association of Europe (ASD)

ASD

Forum Europe

Thales

Safran

Thyssen Krupp

MBDA

Finmeccanica

BAE Systems

EADS

**internet**

World Summit on the Information Society (WSIS)

International Telecommunication Union (ITU)

World Wide Web Consortium (W3C)

IANA

ISOC

Internet Assigned Numbers Authority (IANA)

World's largest open source hardware community (150,000 registered users 2012)

Open Core

GNU General Public License

Creative Commons

Enfopoi

Mainway

Hewlett Packard

Microsoft

Apple

Acer

Intel

Lenovo

Facebook

YouTube

Google

Yahoo!

skype

Jap Bit Valley

Taipei Silicon Island

Ind Bangalore

Isr Silicon Wadi

USA Silicon Valley

**space research**

Outer Space Treaty

Moon 2.0 (Google Lunar X Prize)

International Institute of Space Law (IISL)

USA Jet Propulsion Lab

Commercial Space Federation

Goddard Space Flight Center

Baltic Cosmo drone

Plesetsk Cosmo drone

Luna-Glob

Chandrayaan-1

Indian Space Research Organisation

Satish Dhawan Space Centre

Chang'e 1, 2, 3

Kichang Satellite Launch Center

CASC

China National Space Administration

International Space Station (ISS)

NASA

ESA

ESA Europe

Canadian Space Agency

International Space University

European Space Operations Centre

Mars Reconnaissance Orbiter (MRO)

Mars Society

Mars One

Japan Aerospace Exploration Agency

Tanegashima Space Center

JAXA

Centre Spatial Guyanais

Zooniverse

Network of human volunteers to complete research tasks. Operated by the Citizen Science Alliance. 850,000 volunteers (2013)

**world's medium**

World's largest personal computer vendor

World's second-largest personal computer vendor

World's largest open source hardware community (150,000 registered users 2012)

Open Core

GNU General Public License

Creative Commons

Enfopoi

Mainway

Hewlett Packard

Microsoft

Apple

Acer

Intel

Lenovo

Facebook

YouTube

Google

Yahoo!

skype

Jap Bit Valley

Taipei Silicon Island

Ind Bangalore

Isr Silicon Wadi

USA Silicon Valley

The US federal price tag for the Iraq war — including an estimate for veterans' medical & disability costs into the future — is about \$2.2 trillion dollars. The cost for both Iraq and Afghanistan/Pakistan is going to be close to \$4 trillion, not including future interest costs on borrowing for the wars (http://costsofwar.org).

Iraq estimations: 151,000 violent Iraqi death between 2003 and 2006 (VHCO) 174,000–189,000 violent Iraqi death between 2003 and 2013 (costsofwar.org) 4,388 American death since 2003 (http://casualties.org)

Afghanistan & Pakistan estimations: 100,000 violent Iraqi death between 2001 and 2013 (costsofwar.org) 2,229 American death since 2003

The six reactors in the 2011 Fukushima I Nuclear Power Plant catastrophe had been designed by General Electric. Processes 1,200 metric tons Uranium (MTU) per year.

Westinghouse technology is the basis for approximately one-half of the world's operating nuclear plants. Processes 1,600 metric tons Uranium (MTU) per year.

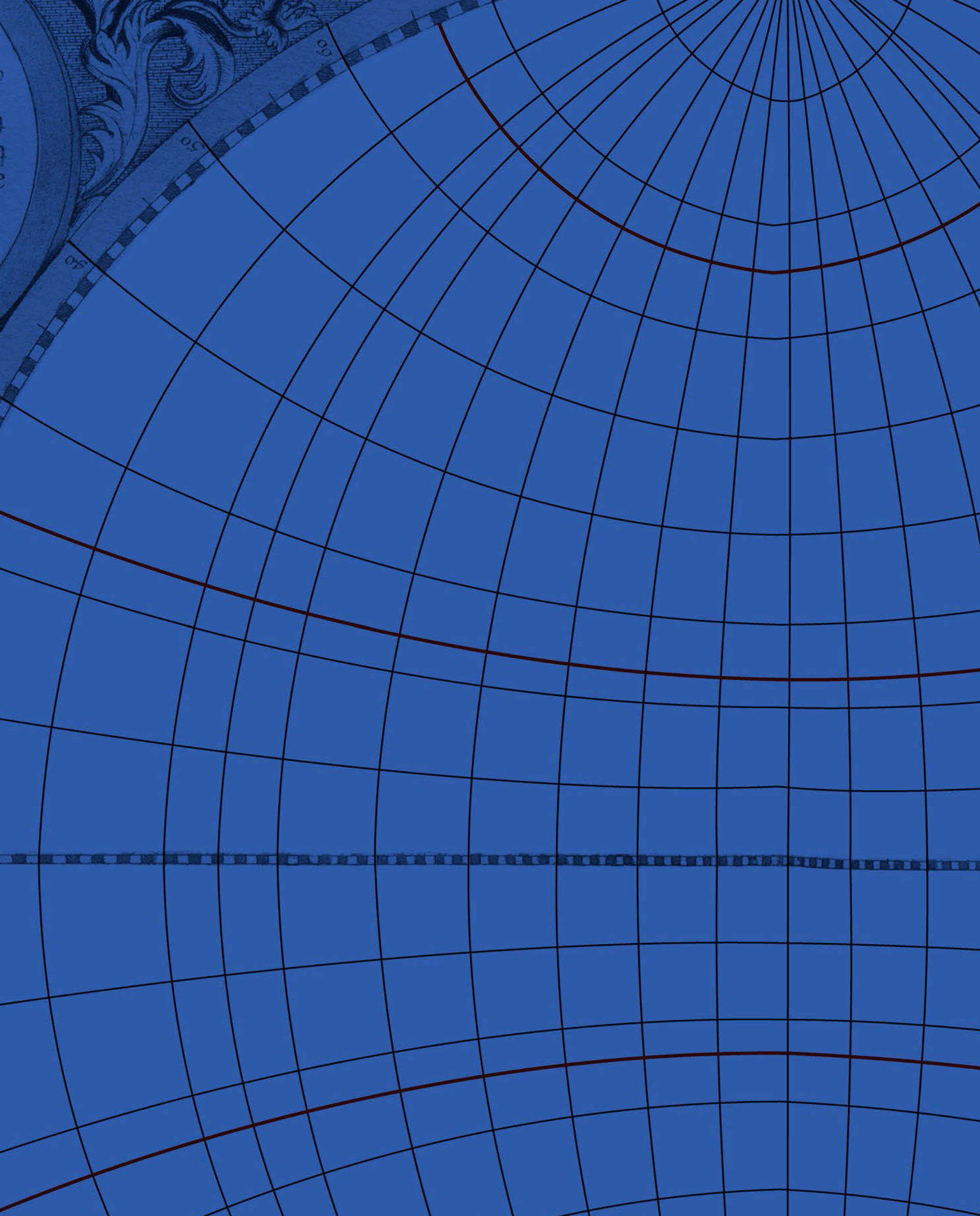

# Counter-Cartographies as a Tool for Action



# Mapping the Anti-Eviction Struggle in the San Francisco Bay Area

Anti-Eviction Map – Erin McElroy

[antievictionmap.com](http://antievictionmap.com)

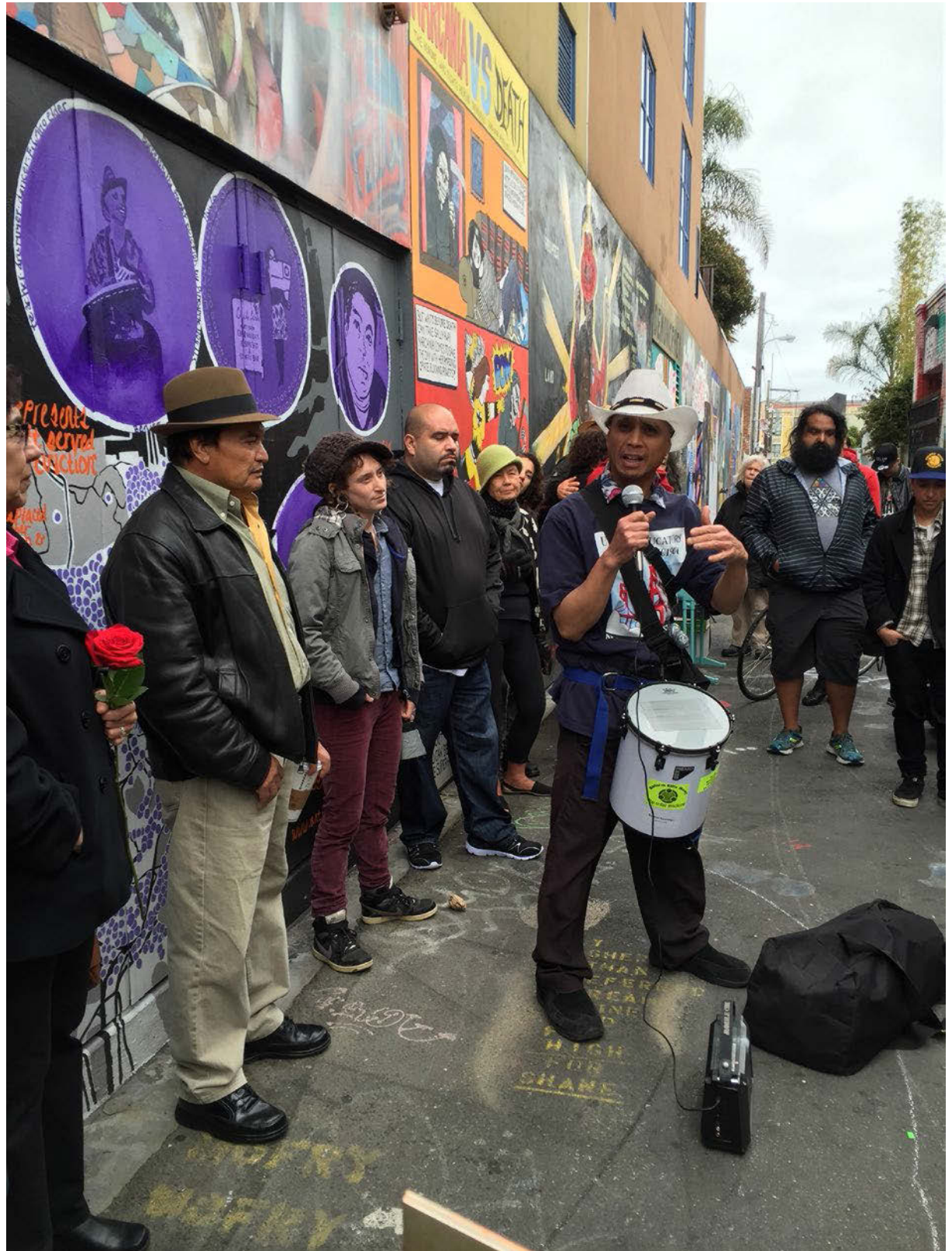



The Anti-Eviction Mapping Project (AEMP) is a data visualization, data analysis and storytelling collective documenting the contours of gentrification in and beyond the San Francisco Bay Area. The project emerged in 2013, focusing on connections between San Francisco real estate speculation and forced displacement, but has since grown in both its geographic scope and methodology. Working regionally, the project now studies the intersectional causes and effects of displacement, while also engaging in narrative mapping work. At times we analyze correlations between rental prices, evictions, and demographic mutation, making use of city and county official data sources; in others, we crowdsource data in the forms of survey, oral history and video work. We firmly believe that no one data set can ever do justice in describing the intricacies and entanglements of what is often discoursed as gentrification in the spaces in which we work, and not even the combined data sets

pacted communities – but with those experiencing the violence of contemporary gentrification.

The AEMP recognizes the representational power of maps and strives to create ones that reveal a counter-history to those employed by the speculators of real estate and Silicon Valley techno-utopics. As we have found, disproportionately, those being evicted from their homes throughout San Francisco, Alameda, and San Mateo counties are Black, Latinx and working-class communities, along with female-headed households, elders and youth, yet inversely, those moving to the region to work in high-paid technology jobs are young white men. Thus, we endeavor to highlight the racial and gendered logics of Bay Area real estate and Silicon Valley incited gentrification while also remaining attentive to the histories that have led to the current moment in which, for instance, evictions are at an all-time high in San Francisco, and in which rents are growing faster in Oak-

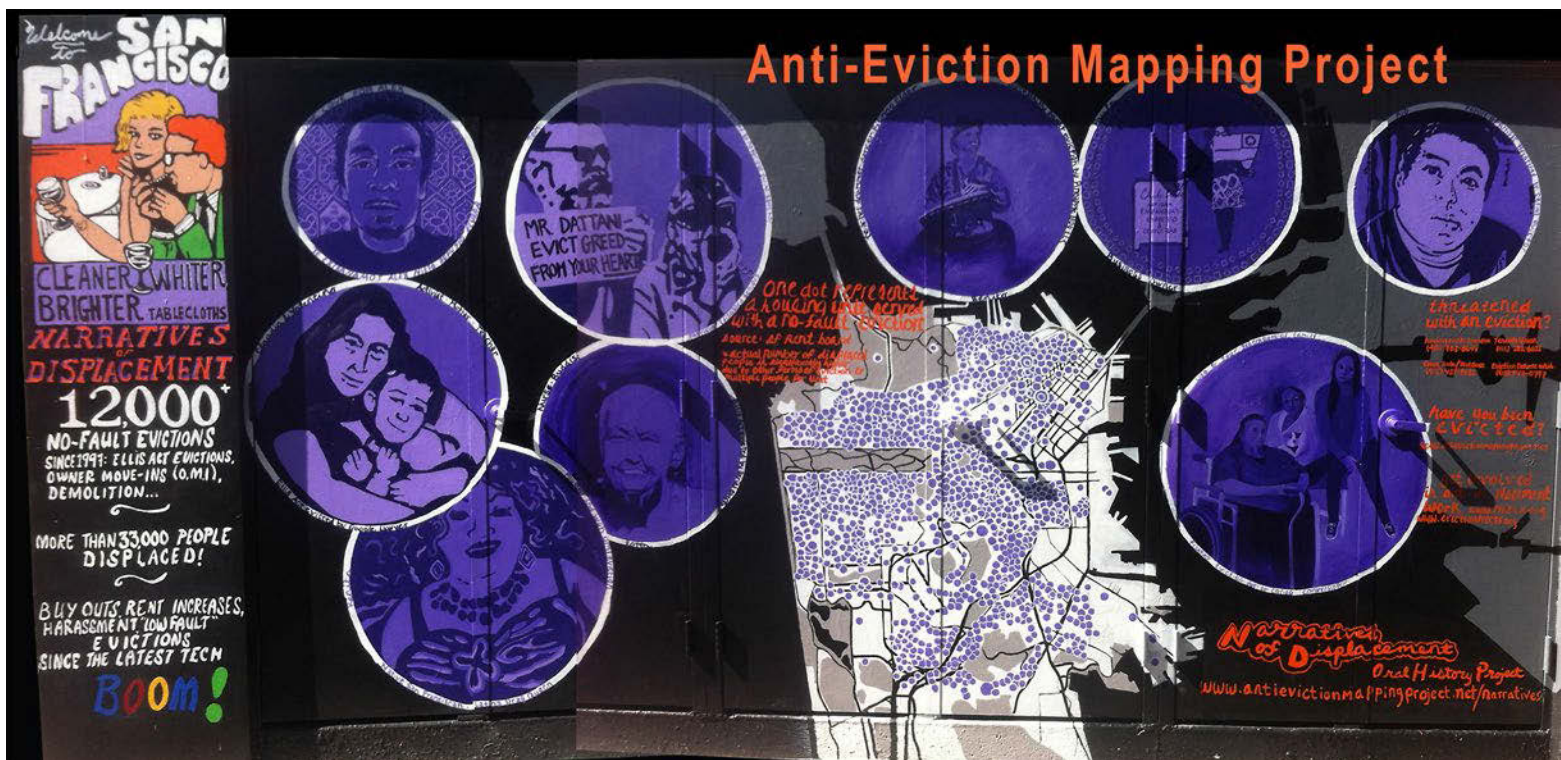

that we work with can fully narrate a history of the present. Nevertheless, we hope that by releasing an array of geospatial visualizations, regional stories of urban dispossession become more lucid.

Over the last four years we have produced over 100 digital counter-cartographic pieces, over 100 oral histories and video works, several reports, murals, projection projects, protests and community events. The conclusions and questions that we invoke in our cartographic projects are conceived of collectively, amongst AEMP members and in collaboration with our community partners. Inevitably, we bring our own situated knowledges to our analytic approach, and as such invoke feminist, antiracist, and decolonial spatial analysis, embracing what we articulate as an abolitionist perspective on private property. In doing so, we practice what Kim Tallbear (2014) describes as "objectivity in action" or inquiring not at a distance but as situated within the spaces we study. As such, we find it important not to produce data "for" im-

land than in any other US city. These histories range from settler colonial ones beginning in the late 18<sup>th</sup> century to those of 1930s redlining federal projects that constituted conditions of racial segregation and racialized disinvestment, to Cold War histories that fomented Silicon Valley regional dominance.

Although our work is largely Bay Area focused, we are increasingly contextualizing our data and maps within broader ones. As the US is being reconstituted by a president and administration built upon white supremacist relationship to private property, our current work seeks to undo the racial logics that have, from the earliest colonial moment, fomented racialized dispossession. At the same time, we seek to produce new maps and data that respond to the current moment, studying past and likely future loss of Section 8 and public housing, the demographics of displacement, the entwining of real estate and Silicon Valley grammars, and the power of community resistance.

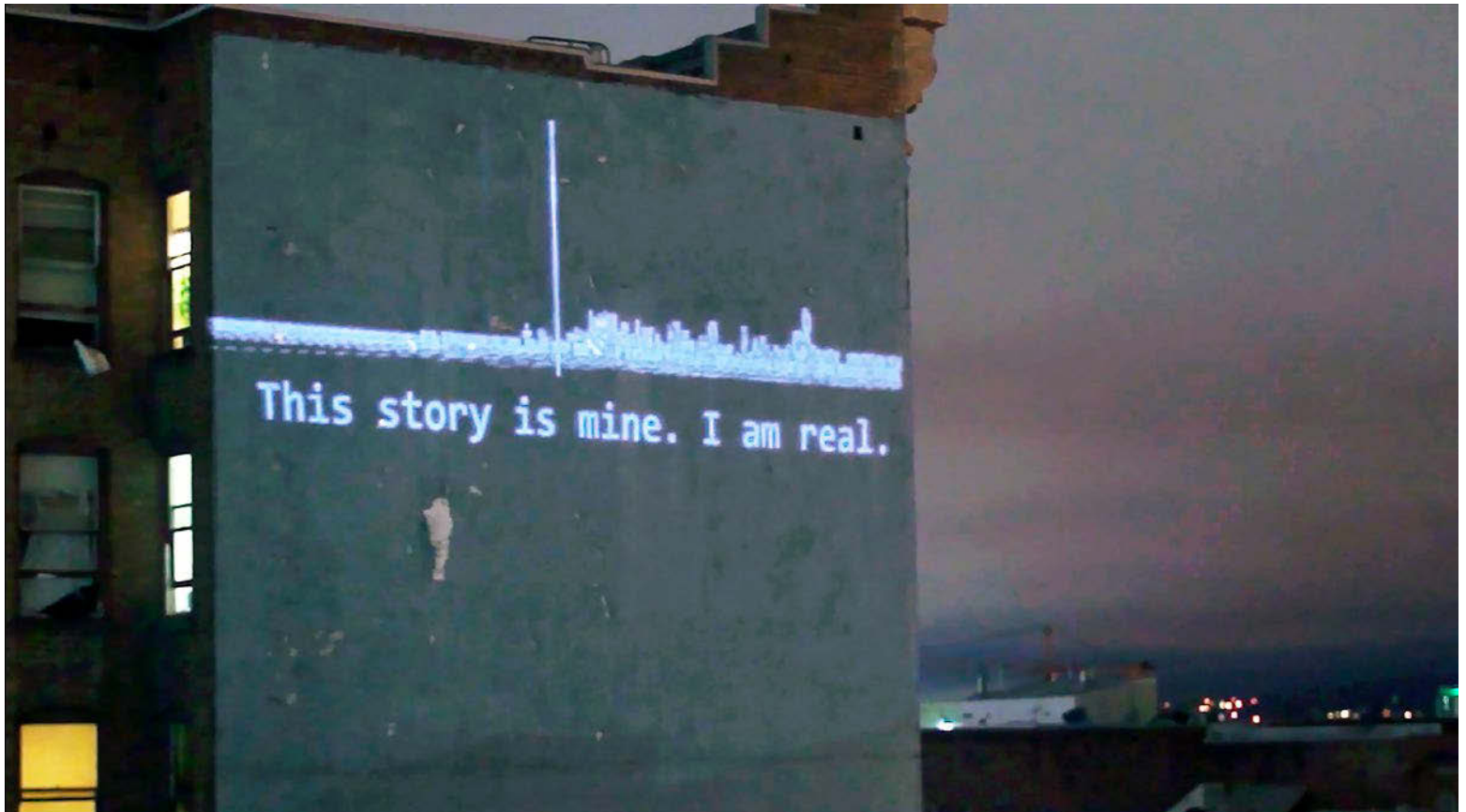

### Narratives of Displacement and Resistance

In 2014, the AEMP launched an oral history project, Narratives of Displacement and Resistance. While we had been producing maps of speculation, eviction, and racialized violence for over a year, we had felt that our maps were not adequately detailing deep neighborhood history and personal stories of loss, change and, not least importantly, protest. Therefore we initiated our oral history project to highlight stories otherwise elided in qualitatively-based counter-mapping. More than anything, we wanted to texture our existing maps with narrative data, offering insight and analytics that only oral histories could produce. We also wanted to publish this content offline, as well as online, and so we began painting a version of the online version in San Francisco's Clarion Alley, in collaboration with the Clarion Alley Mural Project<sup>1</sup>. We launched our online oral history map alongside the release of our mural in 2015. At the time, the oral history map only contained 30 interviews, geolocated upon an interactive interface. At this point, we have recorded over 100 life stories detailing gentrification spatial struggles in San Francisco and Alameda counties. Our mural highlights nine of the San Francisco stories with a call-the-wall feature so that viewers can call a number (+1-415-319-6865) and hear the featured stories. At the time of the release of the mural, many of the tenants featured were still in their homes as a result of direct action, and so their stories serve as direct action tools, with methods, inspiration and analytics useful in fighting displacement. We also included the story of Alex Nieto, who was killed by the police in 2014 as a result of gentrification when newcomers to Bernal Heights racially profiled Alex and called the San Francisco Police Department. We included his story, narrat-

ed by his parents, to mark the intersections of racialized policing and gentrification. The mural also sits directly across from the police station, so its own geolocation is apropos. When we released our mural and oral history map, we also released a zine project that we had been working on for over a year, which included poetry, photographic, drawing and story submissions as well as transcripts of oral histories and know-your-rights resource guides.

### Listen to the Silence Dance Project

Listen to the Silence Dance Project (LTS) was organized by the Stanford community to tell stories that matter to them through their favorite medium – dance. Inspired by the Anti-Eviction Mapping Project in San Francisco, in 2017, the LTS members brought three of their favorite narratives conducted by the AEMP to life through dance.<sup>2</sup>

The danced narratives, as well as all other of the AEMP's oral history narratives, are geolocated online.<sup>3</sup>

*"Growing up in Chinatown, there were always tourists around – we were always on display. This blogger wrote, 'Come to Chinatown. It's cheap, trendy, and ethnic.' ... He doesn't know that the reason why Chinatown is so cheap is because people aren't being paid their wages."*

*"I'm trying to hold on to this place. It's become more of like, I'm losing myself into the fight. To the point where I'm asking myself, do I really want to do this? To myself – or do I really have a choice?"*

# Airbnb Listings and Evictions, 2016

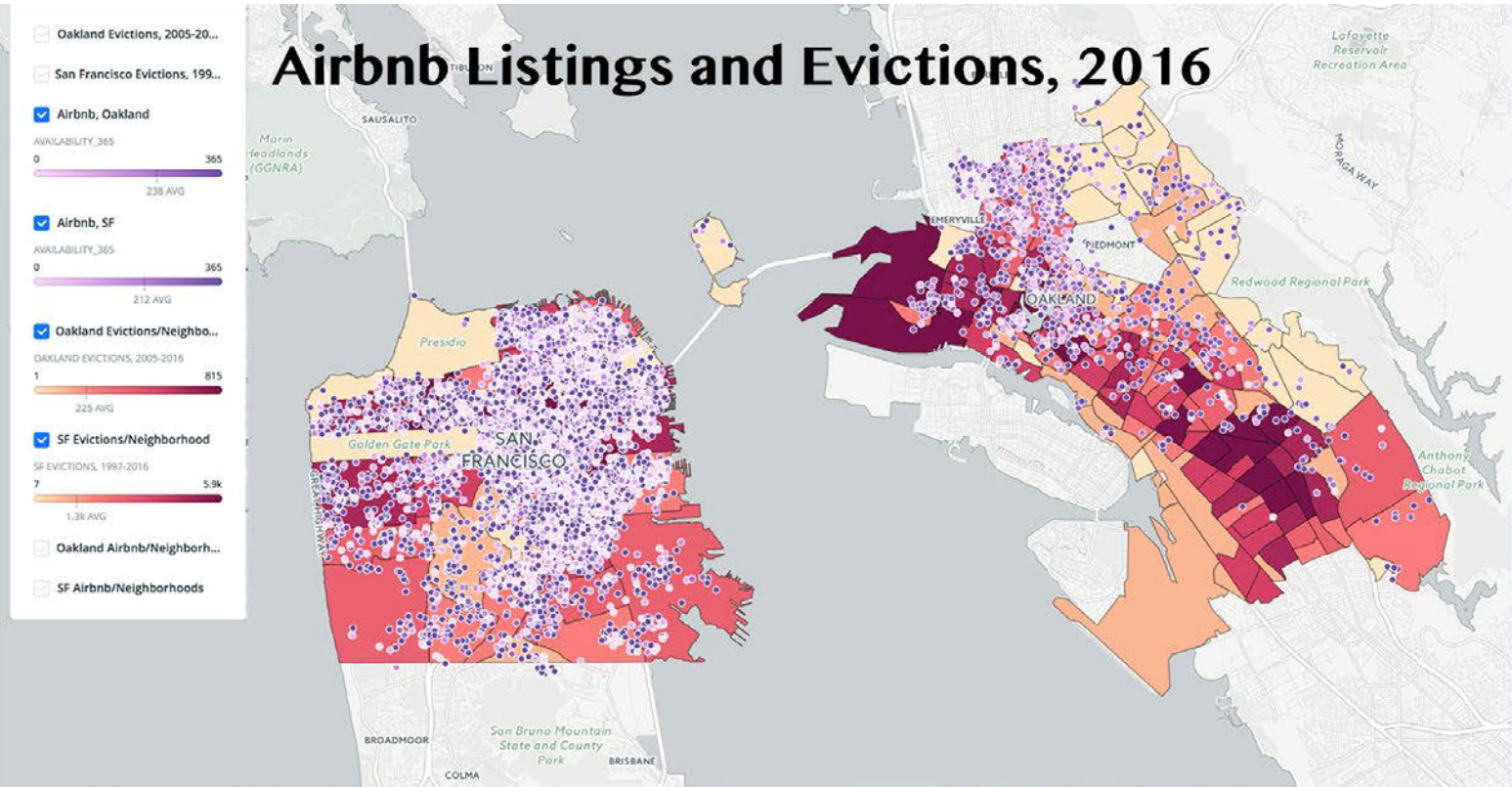

As a “unicorn” startup founded in San Francisco in 2008, Airbnb has since grown its tentacles across the globe, imparting gentrifying effects far and wide. In San Francisco, where there are now over 7,000 listings and in which 57 percent of listings are full-time vacation rentals, there has been a loss of long-term housing as apartments are converted to lucrative short-term rentals. The average room in San Francisco costs over \$200/night, and numerous tenants have been displaced to have their homes transformed to accommodate tourists. As the AEMP has found, there

are serial evictors in San Francisco, such as Fergus O’Sullivan, who have evicted tenants through numerous means and who then have listed emptied rooms on Airbnb. There are even former SRO buildings, such as the Negev, once housing some of San Francisco’s most precarious residents, that are now “digerati dorms,” serving as tech incubation residencies. As the AEMP has found, not only in San Francisco but also in Oakland, Los Angeles and Santa Monica, the neighborhoods with the most Airbnb units are also the neighborhoods with the highest eviction rates.

**DEAR TOURIST, WELCOME TO NOLA!!!!**  
 WE KNOW YOU GONNA HAVE A **JAZZY and FONKY time!!!!**  
*IT'S MAGICAL HERE! THE MUSIC BUBBLES UP FROM THE STREETS!!!*  
*This beautiful neighborhood on high ground and its residents survived Hurricane Katrina nearly intact!!!*  
**Are you staying in an illegal short term rental listed on AIRBNB or VRBO?**  
 If so, then **YOU** are directly responsible for displacing the **last remaining long-time neighborhood residents** that are survivors of the largest disaster that's ever happened in America by creating a market for illegal short-term rentals in this residential area. and THAT, dear tourist, is a **GODDAMN SHAME**  
*Enjoy your stay in our former homes, y'all!!!!*

**DEAR AIRBNB TOURIST,**  
 Your vacation/short term rental has led to the eviction of Chinese immigrant families.  
 We have survived the 1882 Chinese Exclusion Act, 2 World Wars, the 1906 Great Quake and Fires, and the 1989 Earthquake.  
 But now, our lives, our schools, our grandparents' homes, and social fabric are being destroyed.  
**AIRBNB IS DESTROYING OUR HOME**  
 Have A Nice Visit In Chinatown.

**DEAR TOURIST, WELCOME TO VENICE**  
 We hope you are going to have a blast here amongst all this *beauty* and **monuments**.  
 You are also lucky to be part of the last generation that will enjoy this culture that has thrived for more than 1,000 years surviving wars, famine, pestilence and natural disasters.  
 Why we say "the last generation that will enjoy this" ?  
**Well ... are you staying in a short term rental listed on AIRBNB or similar websites ?**  
 if so, then **YOU** are directly responsible for helping displacing the last remaining long-time residents that were the heart and soul of this city before Airbnb and websites that allow tourist rental of whole houses all year long in city centers came along.  
 Your smiling landlord of these days has chosen to join the crowd of venetians that are helping the cultural desertification of this city.  
 More houses every day are bought by heartless speculators to use them as the touristic market and doing this the prices of the houses and rents has become unsustainable for residents forcing them to move away from their town.  
 Until there is a law that will force landlords of Venice to rent whole city to tourists only for a maximum of few weeks every year the tourists will drive residents away from this city leaving only an empty shell for the next generations to visit.  
 And that, dear Tourist, is a **GODDAMN SHAME**  
 Enjoy your stay in our former homes.

*"My mentor owned a warehouse in the mission that he rented out to artists who were trying to stop using drugs and alcohol. We had spoken word, music events, art shows and 12-step meetings – it was a wonderful space. But we lost our home when our landlord evicted us. The city protects the wealthy. These people don't get what makes SF special, and that's why they're going to lose it."*

## Oakland Community Power Map

As part of our partnership with the Oakland Creative Neighborhood Coalition, in 2016 we created a Community Power Map in Oakland's Betti Ono Gallery. This collaborative map was an endeavor in reframing conversations about the Bay Area, so we didn't only talk about loss and destruction but also about community assets worth celebrating and fighting for. The base layer for the map in the Betti Ono gallery was collectively drawn by AEMP and Betti Ono members on two walls, representing Oakland's geography. Following this, members of the public entered the gallery, adding respective assets and markers of community power to the wall.

Before taking the map down, we digitized its contents so that it now lives online<sup>4</sup>. Additionally, since dismantling it, we've created other Community Power Maps throughout the Bay Area, working with youth groups, anti-eviction coalitions and more. But for us, the idea of creating these power maps stemmed from an Oakland-based collaboration in which it was asked of us to think beyond normative pessimistic framings of contemporary Oakland. The digital map is now also part of a report we produced with the statewide tenant advocate group Tenants Together in 2016, titled *Counterpoints: Stories and Data for Resisting Displacement*.

### Endnotes

1. [antievictionmap.com/mural-in-clarion-alley](http://antievictionmap.com/mural-in-clarion-alley)
2. [youtube.com/watch?v=BTzq4qAeXrQ&feature=youtu.be&list=PLiZ-PJjzS3z5tr5S-8PFbI0JB-vcCzlwal](https://www.youtube.com/watch?v=BTzq4qAeXrQ&feature=youtu.be&list=PLiZ-PJjzS3z5tr5S-8PFbI0JB-vcCzlwal)
3. [antievictionmappingproject.net/narratives.html](http://antievictionmappingproject.net/narratives.html)
4. [arcg.is/2bC5f1Y](https://arcg.is/2bC5f1Y)

### References

TallBear, K. 2014. Standing With and Speaking as Faith: A Feminist-Indigenous Approach to Inquiry. *Journal of Research Practice*, 10(2). [jrp.icaap.org/index.php/jrp/article/view/405](http://jrp.icaap.org/index.php/jrp/article/view/405), 14 January 2018.

### Illustrations

Maps by Anti-Eviction Mapping Project

Photograph previous spread left by The Saito Group and Anti-Eviction Mapping Project: Light projection "This story is mine. I am real." This Light Atlas projection is part of a collaborative project conducted between the AEMP and the Saito Group, which involved crowdsourcing eviction narratives and oral histories, and then transcribing them and weaving them together in political-poetic texts. These were then projected upon San Francisco buildings, along with information on fighting evictions.

Photographs previous spread right: signs by Anti-Eviction Mapping Project. These posters were generated by an array of housing justice collectives and activists from San Francisco's Chinatown to New Orleans and Venice. They have been used in protest against the gentrifying effects that Airbnb poses upon specific neighborhoods, in which long-term housing is lost and converted into short-term vacation rentals.



# City of Oakland

## Unlawful Detainers and Foreclosures 2005 -15

**32,402** Unlawful Detainers

**20,340** Foreclosures

**\$2912**

As of July 2016, average apartment rent within the city of Oakland

**\$2488**

Average one bedroom apartment rent

**\$3284**

Average two bedroom apartment rent

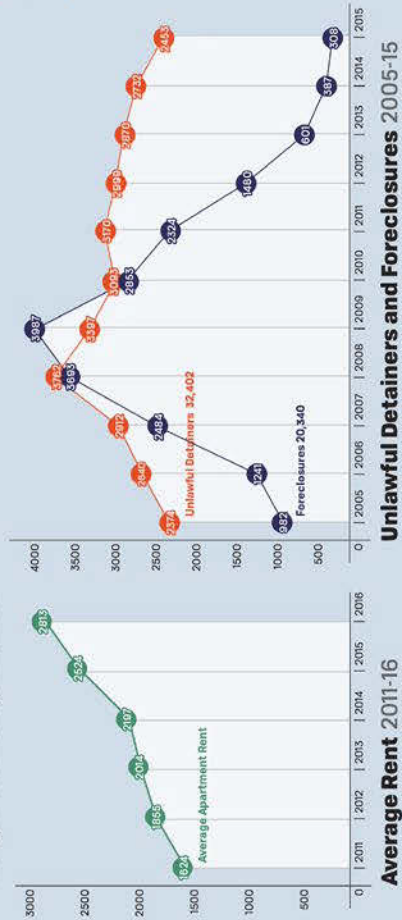

Average Rent 2011-16 | Unlawful Detainers and Foreclosures 2005-15

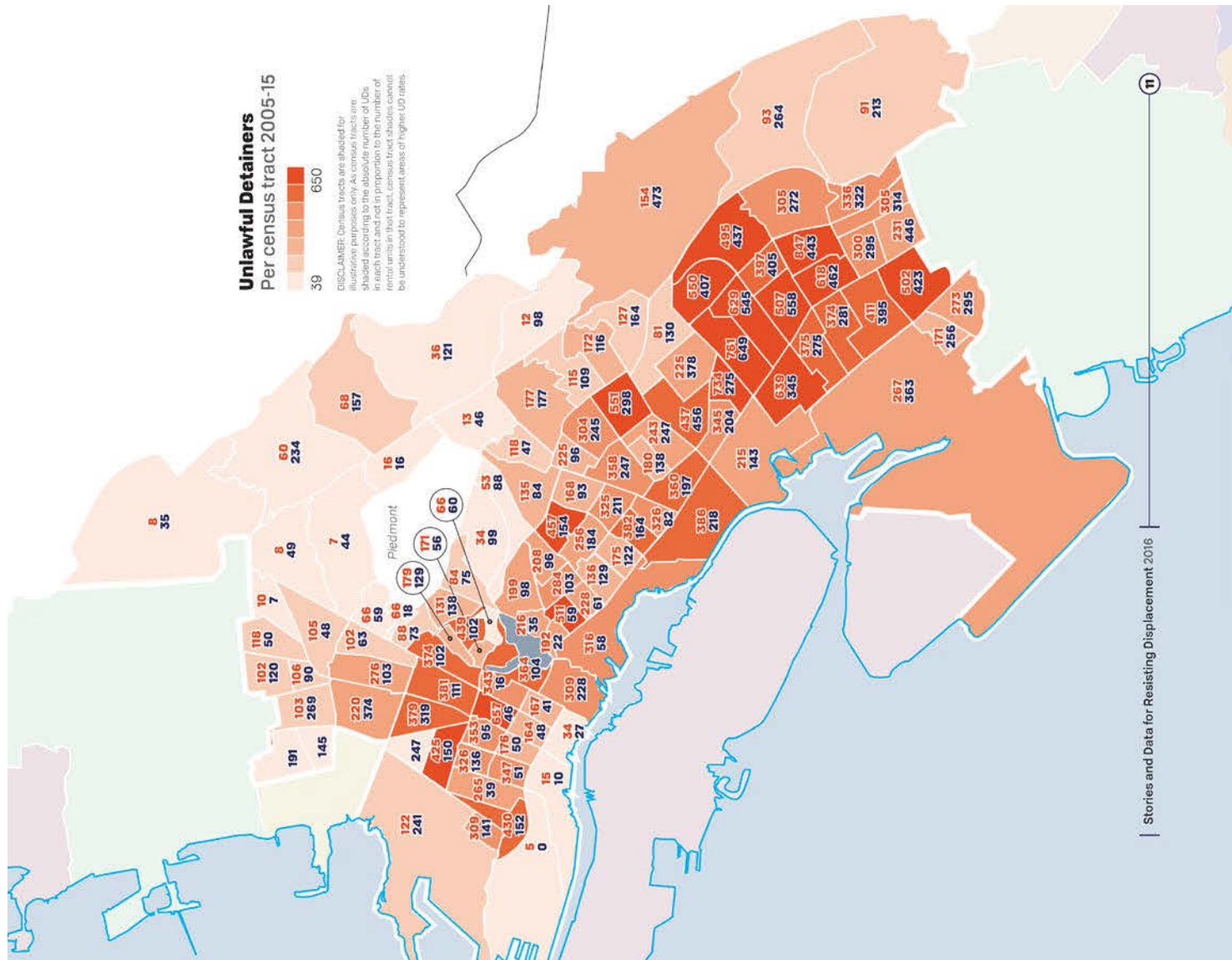

# Anti-Eviction Mapping Project

# OAKLAND COMMUNITY

## #MARCH4OAKTOWNARTS - CULTURE



# UNITY POWER MAP

## LOCAL EQUITY NOT DISPLACEMENT



# A New Social Cartography<sup>1</sup>

## Defending Traditional Territories by Mapping in the Amazon

Projeto Nova Cartografia Social da Amazônia – Alfredo Wagner Berno de Almeida, Sheilla Borges Dourado, Carolina Bertolini

[novacartografiasocial.com](http://novacartografiasocial.com)





Through the use of social mapping techniques, the research work of the New Social Cartography of the Amazon Project (PNCSA)<sup>2</sup> seeks to analyze the differentiated processes of territorialization which are currently underway in the Amazon region. In doing so, the work focuses on the relationship between these processes and the emergence of collective identities embedded in social movements. These identities are multiple and make up an often overlooked Amazonian socio-cultural diversity. The different collective identities are held together through local denominations such as: riverside dwellers (ribeirinhos), rubber tappers (seringueiros), maroons (quilombolas), indigenous peoples, piassaba palm extractors (piaçabeiros), small-scale fishers (pescadores artesanais), nut collectors (castanheiros), artisans (artesãos and artesãs)<sup>3</sup>, urban indigenous communities, babassu coconut collectors (quebradeiras de coco babaçu) and collectors of açai fruit (peconheiros).

Each of these categories of identity defines itself according to its organizational form. Through successive mobilizations they construct their own specific territories. Through a growing cultural self-awareness they have mobilized forces in order to defend their territories from predatory commercial interests. Companies that seek commercial interests are mostly responsible for environmental devastation in the Amazon, especially deforestation and contamination of water resources. For this reason, social movements have carried out campaigns against loggers, large farming and cattle ranching projects, iron-ore plants and mining companies.

The central issue is that indigenous and maroon lands, like those effectively controlled by traditional peoples and communities, are currently threatened by this expansion. The threat derives from the fact that these traditional peoples and communities live and occupy areas of great environmental preservation and significant vegetation cover. Social mapping produced by communities about their own territories translates this strong environmental consciousness and its effects into cartographic representations.

The objective of PNCSA is to map these popular mobilization forces while describing and geo-referencing them based on what is considered to be relevant by the studied communities themselves. At the same time the mapping work presupposes training and capacity building of members of these communities. Teaching the community members about constitutional provisions, pertinent environmental legislation and the use of elementary GPS techniques makes up an initial stage of the PNCSA work. Such capacity building is consolidated through the mapping workshops carried out in the communities themselves. In accordance with a composition defined by their own members, these workshops result in activities that delimit perimeters and solidify information obtained through direct observation and from different kinds of stories. This contributes to a sufficiently precise ethnographic description. Throughout the fieldwork we verified the recurrent use of the expression "traditionally-occupied lands"<sup>4</sup> in the lists of the social movements' demands. This was a constant reference, and it may indicate a growing perception of these social agents in regards to violations of their territorial rights.

Social movements that demand the recognition and protection of human rights regarding special identities in urban areas are partners in social cartography as well. Representatives of other

minority groups, such as lesbians, gays and transgender activists in Manaus, also produced their maps, through which they intended to become visible to the State and other social agents.

In order to facilitate wide dissemination, the results of the work are published in the form of booklets (fascículos) containing maps, excerpts from narratives created by members of researched communities as well as the group's demands. The members of the mapped communities mainly distribute these booklets themselves.

PNCSA has also been establishing itself through an articulation from researchers belonging to higher education institutions on the one hand and participants of social movements in the Pan-Amazon on the other hand. As of today, their main goal is to strengthen territorial rights of traditional peoples and communities.

So far the maps have become supportive instruments managed by traditional peoples and communities for demands addressed to the State as well as for demands against the State. The maps are produced by members of the communities themselves through the mapping workshops that take place within the community. They have become technical resources that ensure accuracy and precision regarding the boundaries of the territories proposed by community associations and social movements.

Since the publication of the book *Carajás: The War of Maps* (Almeida, 1994) we have been consolidating the basis of the New Social Cartography. The critical aspect is the evidence that there is an internal conflict in the lexicon inside the field of knowledge on social cartography. In this sense, the term "New" in the expression New Social Cartography corresponds to a critical analysis of the conventional use of other similar expressions like "participatory mapping", "collaborative mapping" or "cultural mapping", used by the World Bank or by big enterprises like Google, megaprojects and NGOs. These mappings correspond to practices in which the "participation" of traditional people and communities is commonly restricted to limits, and sometimes these limits turn "participation" into mere "ratification" of decisions taken by someone else.

## Producing Situational Maps

As mentioned earlier, the research experiences of the PNCSA focus on diverse situations in which social agents use their ethnic identities in order to categorize themselves and others with the goal of interacting and forming political collectives in an organizational sense. Ethnicity thereby serves as a collective mode of action and representation. We have focused the fieldwork and analyses on the ethnic boundaries that define groups and not on the cultural content that they express. They reflect a new reality and more precisely the tendency of groups to invest deeply in a collective identity in order to demand rights that are essential to their physical and cultural reproduction. This new reality appears to be associated with the self-definition of social agents and their condition as legal subjects.

In accordance with PNCSA techniques, one could say that the situational maps refer to concrete occurrences of conflict in regions which are already delimited with relative precision. The goal is to delimit specific territorialities, providing conditions for a more detailed description of the elements considered relevant by the members of the studied communities in order to make up a cartographic base. In this sense they are different from thematic



maps since they consider sketch-maps as being part of the choices made by social agents in order to compose the maps that should be included in the booklet<sup>5</sup>.

The situational map explains the dynamic character of the mapped realities. It reflects the communities' points of view at a given moment and may also present changes depending on the processes taking place in the territories and the perceptions of the members of the mapping communities.

The work of social mapping thus includes two aspects: an ethnographic one, which requires academic work, direct observation techniques, detailed descriptions and criteria to select information, and another one carried out by the social agents themselves, defining the use of instruments, their choice, the selection of what is included in the map. PNCSA not only contributes to the training of social agents, but also respects their autonomy of practice. Therefore, the decisions are left to the local communities after they have learned techniques to tie together GPS points and other basic technical resources. They can decide whether to include or exclude information which is not regarded intrinsic or which is confidential. This is not a purely quantitative mapping of certain vegetation types, biomes or ecosystems. It is rather a social mapping that produces material, termed situational maps. They are distinguished from participatory maps. Because participatory maps, such as planning instruments, are defined by planners in order to incorporate communities in decisions which are made for them or will affect them. Unlike these maps, our social mappings work in favor of social movements and collective identities as well as intrinsic organizational forms (of mobilization and solidarity) adopted by the groups themselves (Almeida, 2013: 157-173).

Manual work is usually seen separately from intellectual work. We, on the contrary, believe that both forms of work are considered intellectual work. Besides, other traditional people, communities, indigenous and maroons have also become capable of using a GPS or software like ArcGIS. The use of these technological tools combines the technical competence with the community's interests. In this context, the technical expertise provided by universities in producing maps together with communities is associated with the

"militant capital"<sup>6</sup> belonging to associations and representations of peoples and communities. This combination considerably broadens the spectrum of map production and profoundly redefines the current use of "participation" in social mapping.

This way, traditional communities become a source of information production. In continuation, traditional communities may also be able to monitor their own territories in the near future. They will be able to manage it in real time, despite of difficulties, such as the need to learn how to interpret satellite images or challenges, such as finding clear images of the Amazon region due to constant cloud cover. In response to this impediment, the use of drones has been pointed out as a solution for obtaining better imagery.

### Social Conflicts and Maps

In many situations the maps and booklets functioned as a pressure device, demonstrating the weakness of official decisions and showing evidence of the gaps in which municipal leaders could intervene. In this sense, the recourse to ethnography provides scientific authenticity to indigenous demands. In Jambuaçu (Pará), where maroons suffered serious damages from the explosion of a mineral pipeline inside their villages, the booklet was used in the judicial process requesting compensation for environmental damages. Within their urban perimeter, the indigenous people of the Beija-Flor Community, Rio Preto da Eva (Amazonas), pressured the municipal government to expropriate the area and grant it to them – after decades of conflict. In the municipal councils of Rio Preto da Eva and Novo Airão (Amazonas) indigenous members, maroons and riverside dwellers held up their hands showing the booklets they produced themselves. The booklets are seen as documents that show the evidence of their territories. In the case of Novo Airão, the areas set aside for the Jaú National Park overlap the remnant areas of maroons in Tambor. The maroons appreciated the experience of producing that map, which became a required reference document for anyone interested in understanding the dynamic of the conflict. They released the booklet in the Municipal Council of Novo Airão in order to make their territorial demands public.

Following this and through their use for political mobilization, the maps were transformed into instruments of struggle once they focused on territorial and ethnic rights. In the conflict between the maroons from Alcântara (MA) and the Brazilian Space Agency (AEB), the intrusion on maroon territory was ethnographically documented by a historian and by agricultural technicians who were also members of maroon families having been displaced in 1986. These professionals attended technical training courses provided by PNCSA and carried out all the mapping work. We have witnessed an undeniable political dimension, which organizes demands through the construction of the maps themselves, making this work support mobilization and reinforcement of ethnic identity.

The work of PNCSA has been carried out since 2005 through processes of politicization and criticism of geographisms (approaches that restrict the territory's mapping exclusively to a physical dimension) as well as the old vision of biologized agents (representing the acting subject from an exclusively biological or genetic point of view). The mediator's position assumes a new form, and academic participation takes place through criteria of

competence, expertise and scientific wisdom. There is an intellectual division of labor that requires acuity in the elaboration of maps and booklets. Research relations have been patiently constructed, especially given that this is a period of attempts to institute new rules of tutelage (legal subordination to a tutor) through the redefinition of strategies by many NGOs (Almeida 2008a: 105). Renewals among social movement leaders on a large scale have also played an important role.

In all of the situations studied, a recurring point of critique refers to the "personification of collectives" (Micelli, 2007), which is evident in phrases such as: "Indigenous people think that..." or "Peasants don't accept that...". We avoided to reproduce these commonplaces and decided to publish a list of those presented in map workshops, showing the authorship of the correspondent talks. The booklets therefore have multiple authors. Another difficulty concerns the attempts to usurp political representation by traditional peoples and communities, which leaves the action of mediators open to constant questioning.

In this respect, social mapping represents an instrument that strengthens the emergence of collective identities and at the same time balances out the emphasis on biodiversity. This focus on natural elements usually appears in environmentalist speeches regarding the Amazon region.

Therefore, social mapping creates ties to cultural diversity and to the mobilization of traditional peoples and communities regarding territorial and cultural rights.

#### Endnotes

1. This article and all its illustrations are licensed under a Creative Commons Attribution-NonCommercial-NoDerivatives 4.0 License (CC BY-NC-ND 4.0).
2. The New Social Cartography of the Amazon Project (PNCSA) began in 2005, linked to the Federal University of Amazonas (UFAM) and financed by the Ford Foundation. Currently there are approximately 270 organizational forms and 240 researchers participating in PNCSA activities. Since 2005 PNCSA has produced 163 booklets, 70 books, 17 map syntheses, 21 bulletins, 12 videos, 3 catalogues, 6 reports, 5 exhibitions, 10 brochures (cadernos) and 10 situational maps, mobilizing different organizational forms. Around 230,000 copies of booklets with maps have been produced and serve as established instruments for demanding the recognition of traditional peoples' and communities' land rights. In 2016, the access to the PNCSA website exceeded 93,000 hits involving 109 countries.
3. These groups use various fibres, such as arumã, tucum, cipó ambé, as well as leaves and seeds.
4. "Traditional occupied lands" is the same expression found in the article 231 of the 1988 Brazilian Constitution and the articles of the ILO Convention 169, ratified by the Brazilian State in 2003 (Almeida 2008b: 138).
5. One of the most complete examples of this instrument's application, called a situational map, can be found in: *Guerra Ecológica nos Babaçuais*, by Alfredo Wagner, Joaquim Shiraishi and Cynthia Carvalho Martins, published by PNCSA in 2005.
6. "To speak of militant capital is to insist on a dimension of commitment, of which political capital renders insufficient account" (My own translation; Matonti & Poupeau, 2004: 7).



#### References

- Almeida, A.W.B. de, Shiraishi, J. & Martins, C.C. 2005. *Guerra Ecológica nos Babaçuais: O Processo de Devastação dos Palmeirais, a Elevação do Preço de Commodities e o Aquecimento do Mercado de Terras na Amazônia*. São Luís: MIQCB.
- Almeida, A.W.B. de 1994. *A guerra dos mapas*. Belém: Falangola.
- Almeida, A.W.B. de 2008a. *Antropologia dos 'Archivos' da Amazônia*. Rio de Janeiro: Casa 8.
- Almeida, A.W.B. de 2008b. Terras de Quilombo, Terras Indígenas, 'Babaçuais Livres', 'Castanhais do Povo', Faxinais e Fundos de Pasto: Terras Tradicionalmente Ocupadas. *Manaus: PPGSCA/UFAM*.
- Almeida, A.W.B. de 2013. Nova Cartografia Social: territorialidades Específicas e Politização da Consciência das Fronteiras. In Almeida, A.W.B. de & Almeida Farias Júnior, E. de, eds. *Povos e Comunidades Tradicionais. Nova Cartografia Social*. Manaus: UEA Edições: 157-173.
- Bourdieu, P. 1998. *Contrafogos: Táticas para Enfrentar a Invasão Neoliberal*. Rio de Janeiro: Jorge Zahar Editor.
- Hobsbawm, E.J. 1998. *A Era Dos Extremos: Breve História do Século XX, 1914-1991*. São Paulo: Cia das Letras.
- Matonti, F. & Poupeau, F. 2004. Le Capital Militant. *Actes de la Recherche en Sciences Sociales*, 155(5): 4-11.
- Miceli, S. 1992. Introdução: A Força do Sentido. In Miceli, S. ed., *Bourdieu, Pierre. A Economia das Trocas Simbólicas*. São Paulo: Perspectiva.

#### Illustrations

Photograph previous spread by PNCSA: Indigenous Kaxinawa from Rui Humaitá producing sketches during mapping workshop.

Photograph opposite page by PNCSA: Marrons from the river Andirá, community Barreirinha, producing a sketch during mapping workshop together.

Photograph above by PNCSA: Indigenous women from the river Cuieiras, community Manaus, learning how to register coordinates with GPS equipment.

# Beija-Flor I Indigenous Community - Preto da Eva River - Amazonas



- Use of seeds and Forest residue for handicraft manufacture
- Açaí
  - Arumã
  - Bacaba
  - Caruru
  - Chumburana
  - Inajá
  - Lágrima de Nossa Senhora
  - Morotobi
  - Pataú
  - Pachuba
  - Puká
  - Pupunha
  - Taboca
  - Tento
  - Tucumã
  - Tucumãí
  - Turi
  - Pau-Brasil trunk

From this limit inwards to the community, it is called Igarapé de Sakio, outwards, to the city dwellers, it's called Igarapé do Selvagem

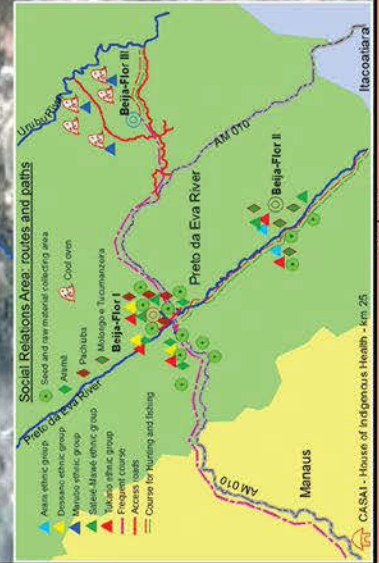

- Legend**
- Community Area
  - Trajectory dome with GPS
  - Community's Entrance
  - Tijual and Ceremonial Hut
  - Art and Indigenous health Hut
  - Tukano Ethnic group's Hut
  - Mayuna Ethnic group's Hut
  - Baniwa Ethnic group's Hut
  - Dessano Ethnic group's Hut
  - Baré Ethnic group's Hut
  - Mura Ethnic group's Hut
  - Sateré-Mawé Ethnic group's Hut
  - Sateré-Mawé / Arara Ethnic group's Hut
  - Mr. Charles' Hut
- Social Cohesion Forms**
- Bath
  - Jabutí's Ritual Place
  - Adventist Church
  - Pathways
  - Bridge
- Agricultural activities**
- Children's city - Sports court
  - Forest
  - Manioc plantation
  - Old plantation
  - Medicinal plants plat
  - Flour House
  - Vegetables and greeneries plat
  - Old site for wild pig raising
- Conflicts**
- Polluted river
  - Northwest part of the limit
  - Community's limit sign, gun shot
  - Area invaded by neighbors
  - Invaded area, road opened by private groups
- Conventions**
- Road
  - Rivers and small rivers
  - Flooded Areas

**New Social Cartography of the Amazon Project**

October, 2007

Source: Map sketches of Beija-Flor I, II and III Indigenous Communities Workshops done on October 19th and 20th, 2007 - Rio Preto da Eva GPS spots survey Google Earth image digitalized, accessed on October, 2007.

Production team: Emanuel de Almeida Farias Junior, Willas Dias da Costa, Gládemir Sales dos Santos, Nadja Christine de Castro Souza, Ana Kátia Santana Cruz, Joaquim Sampaio, Sérgio Campos Sampaio, Pedro Caetano Willot, Germano José Borges Campos, Fausto de Andrade Costa Filho.

Cartography: Luis Augusto Pereira Lima 1:5.000

Geographical Coordinates System - Datum Geodésico Horizontal - SAD 69

59°42'10"W 59°41'50"W 59°41'30"W

0 25 50 100 150 200 250 300

2°41'20"S 2°41'20"S 2°41'20"S

59°41'40"W 59°41'20"W 59°41'00"W

AM 010



# MAPA DA ALDEIA BOA VISTA

ILUSTRAÇÃO: - Professor João Nilson.  
 - A.C.T.S. Maria Angélica de Oliveira  
 - Alunos do 1º ano do Ensino Fundamental I  
 - Alunos do 2º ano do Ensino Fundamental I coordenadora



# Territory of Remaining Quilombo (maroon) Communities

## Alcântara - MA



540000 550000 560000 570000

976000 975000

976000 975000

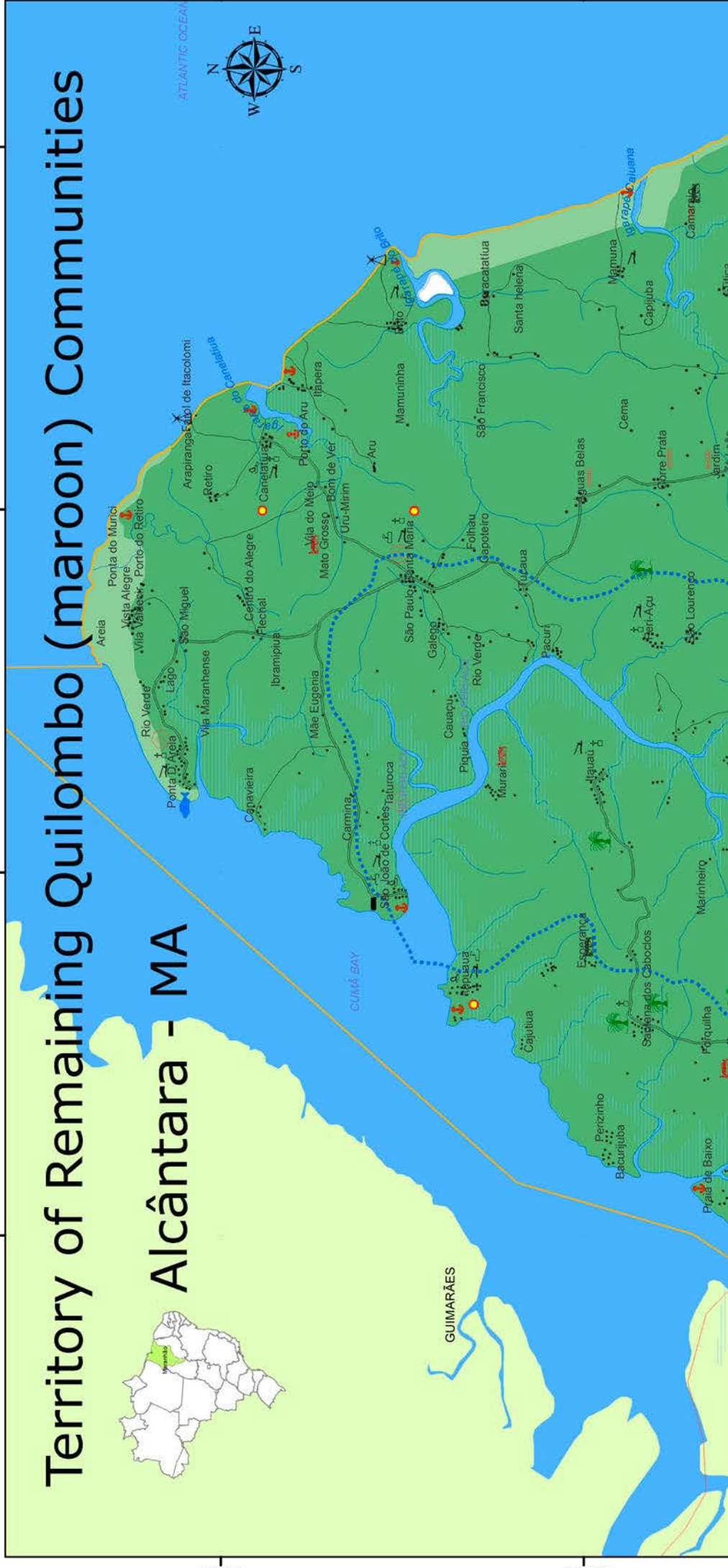

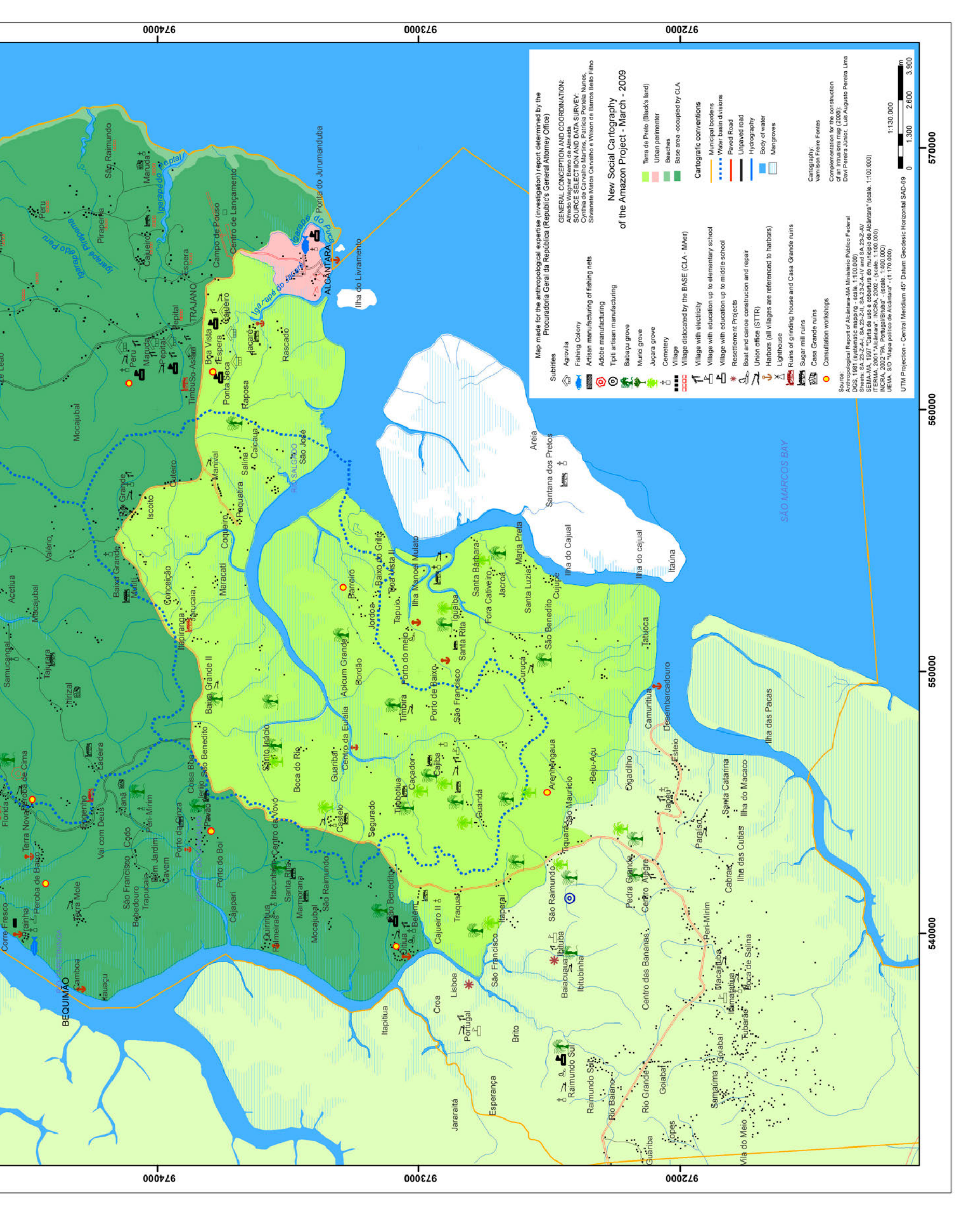

**Map made for the anthropological expertise (investigation) report determined by the Procuradoria Geral da República (Republic's General Attorney Office)**

**GENERAL CONCEPTION AND COORDINATION:**  
Alfredo Wagner Bemo de Almeida

**SOURCE SELECTION AND DATA SURVEY:**  
Cynthia de Carvalho Martins, Patrícia Portela Nunes, Silvanete Matos Carvalho e Wilson de Barros Belo Filho

**New Social Cartography of the Amazon Project - March - 2009**

**Subsites**

- Agrovia
- Fishing Colony
- Artisan manufacturing of fishing nets
- Adobe manufacturing
- Tipiti artisan manufacturing
- Babau grove
- Murici grove
- Jucara grove
- Cemetery
- Village
- Village dislocated by the BASE (CLA - MAr)
- Village with electricity
- Village with education up to elementary school
- Village with education up to middle school
- Resettlement Projects
- Boat and canoe construction and repair
- Union office (STTR)
- Harbors (all villages are referenced to harbors)
- Lighthouse
- Ruins of grinding house and Casa Grande ruins
- Sugar mill ruins
- Casa Grande ruins
- Consultation workshops

**Cartographic conventions**

- Municipal borders
- Water basin divisions
- Paved Road
- Unpaved road
- Hydrography
- Body of water
- Mangroves

**Cartography:**  
Vanilson Freire Fontes

**Complementation for the construction of an intrusions map (2008):**  
Davi Pereira Junior, Luis Augusto Pereira Lima

**Source:**  
Anthropological Report of Alcantara-MA, Ministério Público Federal  
DGS, 1981 (systematic mapping - scale, 1:100,000)  
SEMA-MA, 1997 "Carta de uso e cobertura do município de Alcantara" (scale, 1:100,000)  
ITERMA, 2007 "Alcantara" - INCRA, 2002 - (scale, 1:100,000)  
INCRA, 2007 "PA Potugalar - (scale, 1:100,000)  
UEMA, 2007 "Mapa político de Alcantara" - (1:170,000)

**UTM Projection - Central Meridian 45° Datum Geodesic Horizontal SAD-69**

Scale: 1:130,000

0 1,300 2,600 3,900 m

974000

973000

972000

974000

973000

972000

570000

560000

550000

540000

# A View from Above

## Balloon Mapping Bourj Al Shamali

Claudia Martinez Mansell, Mustapha Dakhoul, Firas Ismail

[bourjalshamali.org](http://bourjalshamali.org)





Lebanon currently houses 53 percent of a total of approximately 450,000 registered Palestinian refugees (UNRWA, 2016). Bourj Al Shamali is located three kilometers east of Tyre in the south of Lebanon; approximately 22,000 registered refugees live here. From the original 7,000 refugees who fled or were expelled from their homes in 1948, the majority of the population in the camp is currently formed by second and third-generation refugees. Like the other official refugee camps in Lebanon, Bourj Al Shamali suffers from serious problems: no proper infrastructure, overcrowding, unemployment and poverty. To add a further level of complexity, large numbers of Palestinian refugees from Syria have now moved into the camp. The arrival of these twice-over refugees has resulted in a deterioration of the already overcrowded living conditions.

The ancestors of Bourj Al Shamali's population lived in Tiberias and Safad in historic Palestine, now Israel, where they led an agricultural existence that has now been completely lost by camp residents, who have increasingly grown detached from the land (Martinez Mansell, 2016). With this in mind, Al Houla Association, one of the local NGOs working in the camp and the base for the local camp committee that is working to improve conditions in the camp, started exploring the possibility of launching an urban agriculture pilot project and the creation of a green space in the camp. Having worked at various times in the camp over the past decade and a half, I (Claudia Martinez Mansell) became involved in this project.

For this initiative, a map of the camp was needed to discuss potential locations and to visualize potential water sources. But it turns out that it is difficult to find a map of Bourj Al Shamali, even though it has been in existence for over 60 years (UNRWA, 2017). With the complex politics of the region, the maps that do exist are withheld by international organizations that justify their discretion in the name of security and do not share them with the camp inhabitants or with the local camp committee. On online maps only the main street is marked, and on Google Earth the very low-resolution images of the area do not allow you to see the space clearly and to identify the narrow streets and buildings. On one Lebanese paper map of Beirut, for example, the refugee camps appear as grey blobs, providing no details about the interior of these spaces (Ghubril, 2010). This lack of cartographic information stands in stark juxtaposition to the ever-present outlines of historical Palestine that are memorialized on walls and surfaces of Bourj Al Shamali and many other Palestinian refugee camps in Lebanon.<sup>1</sup>

Therefore, in 2015 we decided to launch an initiative in cooperation with the local camp committee's leader, Mr. Mahmoud Al Joumma, in order to map the refugee settlement ourselves. The budget was small, and we wanted and needed to have the whole community on board since this would be the first map produced by and for the camp's refugee community. This turned out to be no simple task. Mapping refugee camps is politically sensitive, and refugee populations are understandably wary concerning the security implications and possible uses of such maps.<sup>2</sup> Aerial photography and mapping processes are permanently associated with military surveillance, having been used for everything from geographic exploration to secret spy missions. Looking for options,

we learned about balloon mapping and decided to use this Do-It-Yourself (DIY) aerial photography tool that could allow us to take aerial images from the camp and use them to produce a map.

To dispel local concerns at Bourj Al Shamali, it was therefore crucial for us to work under the supervision of the local committee. Key local committee members informed the community, the various factions within the camp, and the Lebanese army about the planned balloon flights. Our choice of tool would also prove to be crucial.

Balloon mapping was developed by Public Lab, an open network of community organizers, educators, technologists and researchers that was founded in 2010 as an open-source, grassroots data-gathering and research initiative. Their aim is to democratize inexpensive and accessible DIY techniques in order to address environmental issues that affect people. At the same time, they try to promote a DIY citizenship as a means of transformative political action (Ratto & Boler, 2014). Their tools are an example of the increasing use of new and creative ways to share data on environmental decisions (The Economist, 2008). Balloon mapping was first developed and tested by citizen activists on the Gulf Coast of the USA after the Deepwater Horizon oil spill of 2010. It was a reaction to concerns that the government and BP were not adequately informing citizens about the actual extent of environmental damage. Compared to other mapping platforms that have a more humanitarian focus, such as Humanitarian OpenStreetMap or Ground Truth and Map Kibera (see article page 228), Public Lab's tools take a lower technology, community-oriented approach.<sup>3</sup>

In Bourj Al Shamali, this low-tech approach proved key to solving the problem. At first, there was disappointment from the local committee and key team members at just how low-tech the equipment was: a 1.5-meter wide reusable latex/chloroprene balloon, a 300-meter long line, swivel clips for attaching the balloon and the camera, rubber bands for making a camera cradle, reusable Velcro for closing the balloon, some carabineers to attach things together, and a camera. However, this soon contributed to making our work with the community non-threatening and approachable, when compared to using drones. The simplicity of the process also allowed many people to participate. The digital camera needs to be one that can be set on an automated mode taking images every few seconds. It can be a smartphone or a basic point-and-shoot device set to continuous mode. It is placed in a plastic bottle for protection and secured to the balloon string. The process of launching the balloon is also simple. You tie it all up, you let the helium-filled balloon rise up in the air, and after a flight of 10-20 minutes you bring the balloon down again. For best quality images it is advisable to choose a bright day. It is also important to be on the lookout for obstacles, such as houses, power lines and trees. The altitude of the balloons has an effect on the scale of the map as well as the resolutions of the images. In Bourj Al Shamali we took images at various altitudes in order to ensure high-quality images of rooftops but also good overviews of the camp.

When problems arose, many were able to chip in and help, as for example when a camp carpenter built us a box to protect the camera or when the high school physics teacher offered us ideas about

how to stabilize our camera in the high winds which the balloon regularly encountered. Once our balloon was shot with a pellet gun by some idle youths and the local tire shop tried to patch the holes. We were also continually invited onto rooftops and into people's homes to help us accomplish our work.

After waiting in the tire shop for a balloon replacement, someone suggested that we contact a photographer in the camp who was planning to start using drones to photograph weddings. Like anywhere else, drones have now become accessible and affordable in Lebanon and can more easily accomplish the same tasks as balloons. But as any military operator of drones can tell you, drones offer power while rendering the operator invulnerable; whereas it was precisely the vulnerability of the balloon that necessarily generated conversations around the camp and, with time, won us supporters. The history of drones is that of an eye turned into a weapon (Chamayou, 2015); our red balloon high above the camp was different. It was less threatening and more poetic, with the string tying us to it, acting as some kind of umbilical cord that required us to be present in the spaces we were mapping (if you closely look at the images we produced, you can see us in many of them). Our red balloon was visible from everywhere in the camp, and people often mentioned to us from where they had seen it. This visibility was a way of winning trust.

But mapping with the balloon was not an easy task. There were many false starts, and at times we wondered if we were going to succeed. Mahmoud Al Jomma's wise reflections on our doubts were reassuring: For him, irrespective of what final result we obtained, the balloon had gotten people thinking and talking about mapping and spatial awareness, and this process was already a result. For the youth from Bourj Al Shamali who worked on the project, there was great appeal in knowing that they were bypassing governmental and corporate control over geo-spatial information. In a society where young people encounter so many obstacles in their efforts to contribute to their community, they were happy to be helping with producing something useful for the community and to be given space to solve problems by themselves through experimenting. They were also very excited to be changing the community's as well as their own perceptions of being helpless and ineffectual and to see themselves not as beneficiaries of an innovation but as partners and co-creators of the solutions to their problems.

#### Endnotes

1. For more information on the use of the map of Israel / Palestine as a celebrated symbol by both Israelis and Palestinians see Wallach (2011).
2. The report by UNOCHA, Humanitarianism in the Network Age, includes thought-provoking questions on the possible security implications of satellite imagery produced in Sudan.
3. For a discussion of these approaches see the World Bank report, "Interactive Community Mapping: Between Empowerment and Effectiveness" from 2014.

#### References

- Chamayou, G. 2015. *Drone Theory*. First edition. London: Penguin Books.
- Ghubril, B. 2010. *Zawarib Beirut & Beyond: Road Atlas of Greater Beirut Plus 75 Municipalities from Tabarja to Choueifat*. Beirut: Zawarib SARL.
- Martinez Mansell, C. 2016. Camp Code: How to Navigate a Refugee Settlement. [placesjournal.org/article/camp-code](http://placesjournal.org/article/camp-code), 19 June 2016.
- Ratto, M. & Boler, M. eds. 2014. *DIY Citizenship: Critical Making and Social Media*. Cambridge, Mass.: MIT Press.
- The Economist 2008. Revolutions Coloured Green. [economist.com/node/12641740](http://economist.com/node/12641740), 13 January 2018.
- UNRWA. Burj Shemali Camp. [unrwa.org/where-we-work/lebanon/burj-shemali-camp](http://unrwa.org/where-we-work/lebanon/burj-shemali-camp), 13 January 2018.
- UNRWA. Where We Work. [unrwa.org/where-we-work/Lebanon](http://unrwa.org/where-we-work/Lebanon), 14 January 2018.
- Waldheim, C. 1999. Aerial Representation and the Recovery of Landscape. In Corner, J. ed. *Recovering Landscape: Essays in Contemporary Landscape Architecture*: 120-139.
- Wallach, Y. 2011. Trapped in Mirror-Images: The Rhetoric of Maps in Israel/Palestine. *Political Geography*, 30(7): 358-369.

#### Illustrations

Guide by Grassroots Mapping with Balloons and Kites ([publiclab.org](http://publiclab.org)), licensed under a Creative Commons Attribution ShareAlike 3.0 License (CC BY-SA 3.0).



# An Illustrated Guide to Grassroots Mapping with Balloons and Kites

To learn more, visit <http://grassrootsmapping.org>

Do you want to make maps? Do you need satellite images but can't afford them? Do you want to see your home from above?

Follow these instructions and you can, for as little as \$100!



This work is licensed under a [Creative Commons Attribution-ShareAlike 3.0 License](https://creativecommons.org/licenses/by-sa/3.0/).

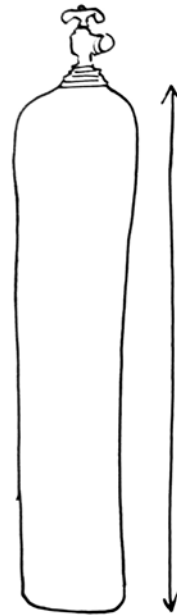

80 cubic feet or 1.5 cu. meters of helium

1m  
80

One 2 meter-wide weather balloon



or 2 mylar sleeping bags



digital camera with continuous mode + 4 gb or larger memory

~200g



scissors

1000m 5kg nylon string for balloons

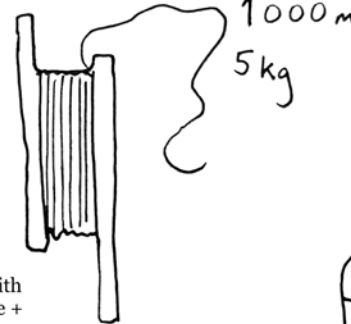

1000m  
5kg

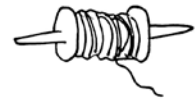

30kg+ strength nylon string for kites



heavy work gloves



2L plastic soda bottle

duct tape, gaffe tape is best

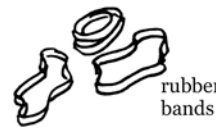

rubber bands

## Choose and prepare your camera

Any digital camera around 2-300 grams that has a 'continuous mode' can work. You can also use a Canon camera with the CHDK to trigger a photo every 5 seconds.

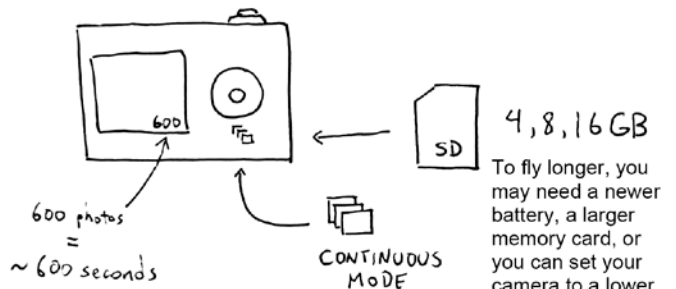

In 'Continuous Mode' a camera takes a picture every 1 second if the trigger is held down. Your display will show how many pictures you can take on your card.

To fly longer, you may need a newer battery, a larger memory card, or you can set your camera to a lower resolution. A 4 GB card fills up in about 35 minutes.

## Build a camera capsule

This simple protective cover stops your lens from hitting the ground, and protects your camera from hitting walls and trees.

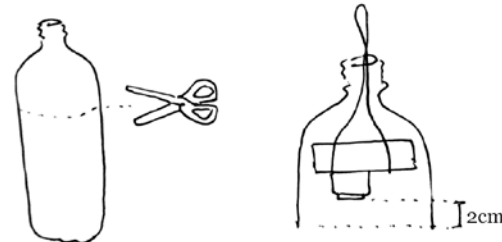

Cut a soda bottle in half and put the camera inside the top with the loop through the bottle neck.

Be sure the camera lens is protected even when it's extended!

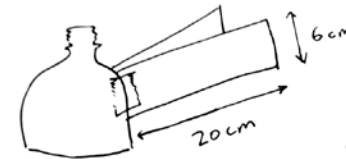

Use the rest of the bottle to make 'wings' to stabilize it in the wind. Cut strips and create them to keep them straight.

## Balloons or kites?

Decide whether to use a balloon or kite based on local wind conditions. While kites are cheaper, they're harder to fly, and you may have to prepare for both:

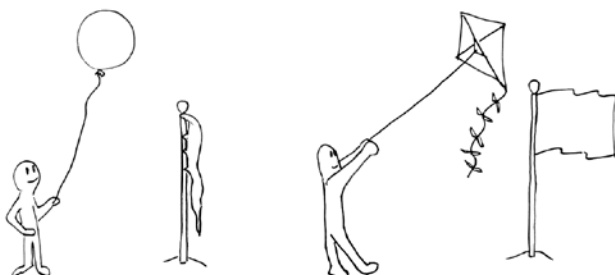

Balloons in <10kph wind; kites in more than that. Look at flags to decide.

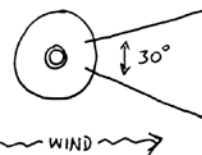

Fold a 1 meter loop of string and tape it firmly onto your camera. Be sure the tape doesn't stop the lens from extending.

Press the tape down hard - its the only thing keeping your camera from slipping out of the string at 500 meters high!

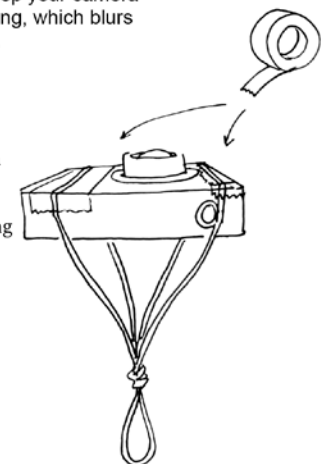

## Set up your camera to auto-trigger

Set your camera on continuous mode. Wad up a bit of card paper or use a pencil eraser to hold down the camera trigger. Use a rubber band to hold it in place and apply pressure. Be sure the button is being pressed - you may have to double the band up.

Move the rubber band to one side until you're ready to start.

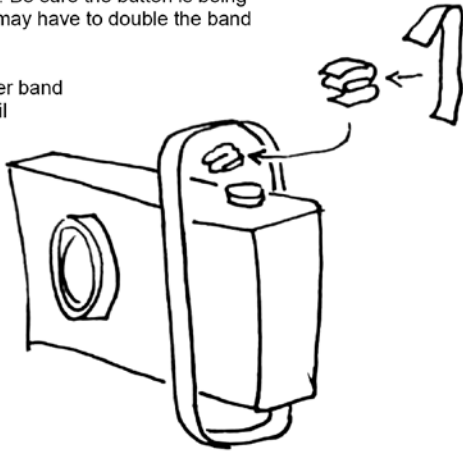

You can add a second loop or a rubber band and hook it on the bottom of the bottle to hold the camera firmly against the top.

Even better, put the cap on over the string when the camera is snugly in place, trapping the string.

Bounce the camera on a mattress and be sure it doesn't scrape the ground or fall out.

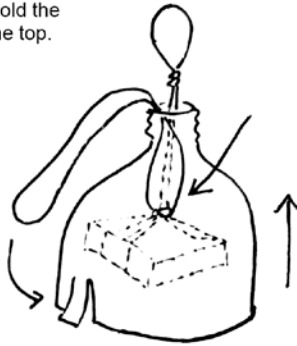

## Prepare and fill your balloon

1.5 meter wide weather balloons work best, but if you can't get one, you can make one from plastic. You can use several giant trash bags, but they won't stay inflated for more than an hour -- mylar or PET plastic is far more airtight.

Where available, *mylar sleeping bags* can be taped shut and will stay filled for several days, unlike weather balloons. Two of these are enough to lift a typical camera.

Test your valve first by letting some helium out with nothing attached. Then put your balloon on and slowly inflate it.

Someone should be in charge of not letting the balloon touch trees, bushes, or the ground.

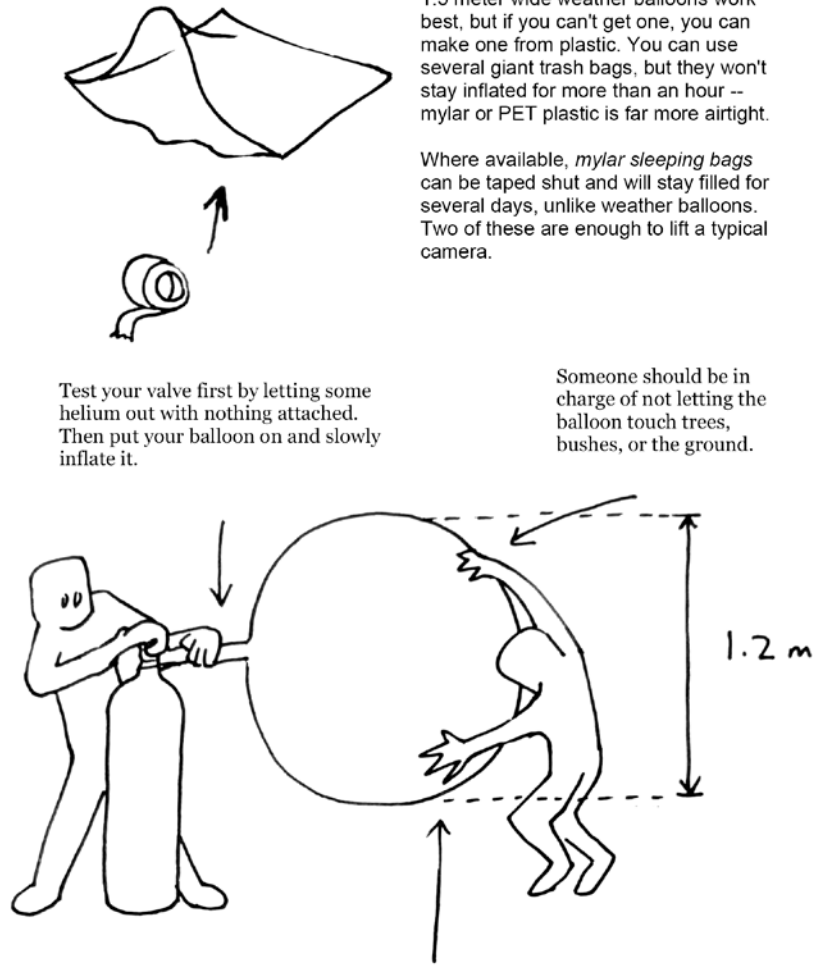

## Flying your balloon or kite

The highest wind is usually around 2pm, and the lowest is at dawn. Bring water and sunscreen if it's hot out, and charge your camera batteries the night before

When using kites, be sure there is at least 5kg of pull, and let out 20 meters of string before making a loop and attaching the camera.

When selecting a place to fly from, you'll have to be upwind of the site you want to map.

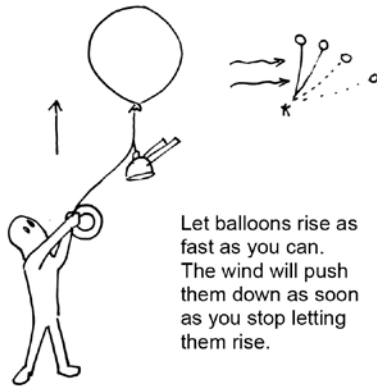

Let balloons rise as fast as you can. The wind will push them down as soon as you stop letting them rise.



Wind the string carefully - don't let it tangle! If it's bad enough you'll have to throw it out.

A second person just to wind the string can be very helpful.

Always wear heavy gloves to prevent string burns!

Don't fly near power lines or in thunderstorms.

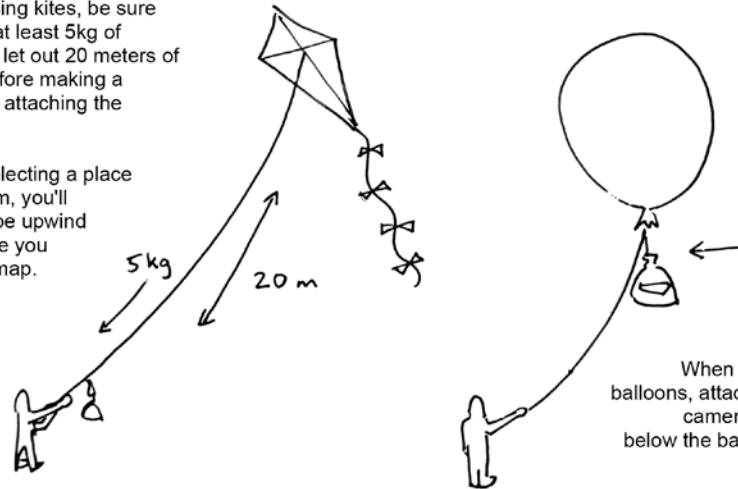
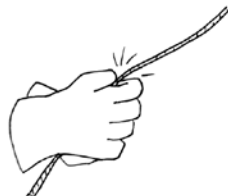

Generally, if you fly 1000 meters high, your pictures will show around 1000 meters on the ground.

Once the balloon is 500-1500 meters high, try walking around to take pictures of a greater area.

A small map usually takes around 2 hours to make.

Bring a GPS if you have one, and write down the latitude and longitude, or record a track.

Even a drawing of your site, or a photo of an existing map is helpful.

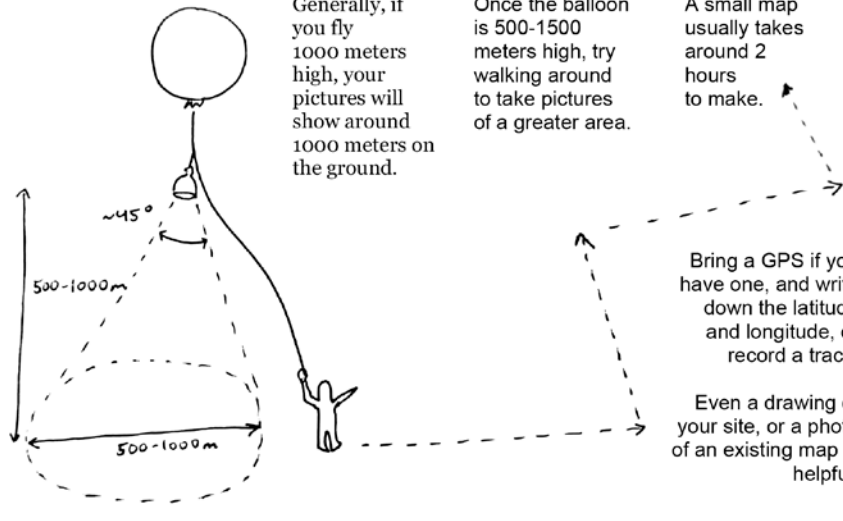

# Mapping Safe Passages

## Real-Time Interventions at the Maritime Borders of Europe

Stephan Liebscher, Ina Fisher<sup>1</sup>  
[alarmphone.org](http://alarmphone.org) / [watchthemed.net](http://watchthemed.net)



During the long summer of migration in 2015, the importance of digital tools for transnational movements of people has been widely acknowledged. While states have been using geographical information and maps to control movements of people across space for a long time, transnational migrants and support network have found creative ways of using online mapping platforms to organise their journey and to evade state practices of control and immobilisation.

Stephan Liebscher (SL) spoke with Ina Fischer (IF), member of the Alarmphone, about the use of the online mapping crowdmap [watchthemed.net](http://watchthemed.net) to ensure safe trips for people crossing the Mediterranean Sea and enable their participation in decision-making.

*SL: Why did the Alarmphone start its work and what are the aims behind it?*

IF: The idea for the project emerged in 2013, after two boats in emergency situations in the Central Mediterranean Sea were not assisted: On 3 October 2013, 366 people drowned close to the island of Lampedusa, yet another catastrophe that could have easily been prevented by means of providing adequate rescue at sea. Only a few days later, again more than 250 people drowned after they had tried to call for help for hours – in vain: Based on accounts of survivors, assistance was knowingly withheld despite numerous SOS calls. The situation of distress and non-assistance was reconstructed in detail on the online monitoring platform [watchthemed.net](http://watchthemed.net). These two cases were a key moment in raising various questions: What would have happened if these people in distress, being systematically ignored by coast guards, had had the option to call an independent phone hotline? Wouldn't it be possible to amplify distress calls through immediate appeals to the public? In October 2014, the Alarmphone started its work: a telephone hotline – working 24 hours – for people in distress at sea, informing coast guards and pressuring rescue authorities in real time via public media and politicians, if necessary. Furthermore, with this work we emphasise migrants' perspectives and build a counter-narrative: We bear witness to the movement of migration from below.

*SL: Can you describe one typical case?*

IF: The conditions differ a lot across the different regions of the Mediterranean. The distance from Turkey to Greece, for example, is just a few kilometres. Travellers in the zodiacs crossing the Aegean are usually well equipped with smartphones. First, we find out about their problem: Sometimes the engine is not working and we can give advice. If people are stranded on an uninhabited island or are in immediate distress, we ask them to send us their current GPS-position via WhatsApp.

The distance to Europe in the Central Mediterranean Sea, however, is very far. For the trip from Libya or Tunisia, people need satellite phones to call us and to figure out their GPS position. Usually there is one phone per boat carrying an average of 150 or more people. The people who try to reach Europe via Morocco to Spain – mostly from sub-Saharan Africa – need to pool money to buy small zodiacs – often even without engine. Crossing the Strait of Gibraltar in a boat with 10 people is a perilous venture!

The people mostly call us on cheap mobiles. Without their GPS position, their lives depend on their exact information about the time and place of their departure. When we are alerted by friends or family members, we ask for a direct contact to the boat. We immediately call the passengers to ask them about their current situation: How many people, women or children are on the boat? Are there any sick people?

*SL: How do you use maps to handle these emergency situations?*

IF: We insert the GPS position of a boat into the map-application on [watchthemed.net](http://watchthemed.net) – a sister project – to figure out in real time which national coast guard is in charge of the rescue, as it shows the so-called official Search and Rescue Zones and other additional layers. The Alarmphone team then forwards all relevant information to the responsible European coast guard. By using the mapping platform, we can also identify if a boat is threatened by an illegal push-back or pull-back by the coastguards. Live tracking maps like [vesselfinder.com](http://vesselfinder.com) or [marinetraffic.com](http://marinetraffic.com) indicate if civilian rescue vessels or cargo vessels are nearby. Other important actors – the military vessels of NATO, Frontex or missions such as EUNAFVOR MED – are not displayed as they can turn off their transmitter. We additionally use wind maps and weather forecasts to learn about potential current risks at sea. In the aftermath, we publish relevant cases on the platform [watchthemed.net](http://watchthemed.net).

*SL: You mentioned the crowdmapping platform [watchthemed.net](http://watchthemed.net). Can you tell us the story behind it?*

IF: [watchthemed.net](http://watchthemed.net) originates from a research project called Forensic Oceanography.<sup>2</sup> It was launched in 2011 to support a coalition of NGOs demanding accountability for the deaths of migrants in the Central Mediterranean Sea while that region was being tightly monitored by the NATO-led coalition intervening in Libya. The efforts were focused on what is now known as the first "left-to-die-boat" case, in which 63 migrants lost their lives while drifting for 14 days within the NATO maritime surveillance area (see illustration below). For the first time, surveillance technologies were used to reconstruct a detailed documentation:

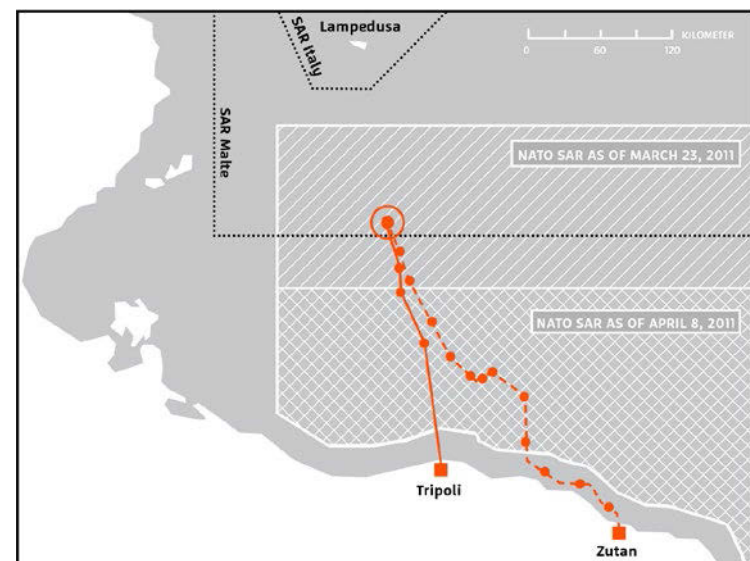

It could be demonstrated with precision how different actors operating in the Central Mediterranean Sea were using the complex and overlapping jurisdictions at sea to evade their responsibility of rescuing people in distress. The report formed the basis for a number of ongoing legal petitions filed against NATO member states. The Forensic Oceanography project was further developed into the monitoring platform Watch The Med. This public platform was launched in 2012 and lets anyone contribute to the map by submitting their own reports of violations of migrants' rights at sea. In the Alarmphone, we build on their experience and use the mapping platform for our real-time interventions.

*SL: The Alarmphone describes itself as an “alternative alarm-phone” for people in distress in the Mediterranean Sea. What is the political dimension of your work?*

IF: All our work is based on the conviction that migration is not a crime, and that state borders serve to prevent people from their right to move around freely. The European Union's alleged fight against smugglers and deaths at sea first of all serves their interest to fight migration to Europe. We do not just answer emergency calls and forward them to the coast guards but also give advice to

improve the situation of the boat people in emergency situations. We inform about safety at sea in different languages via social media, we provide introductions in the use of the GPS function of phones or how to act in cases of hypothermia. As soon as we know the position of a boat, we inform the travellers in which SAR zone they are located and which coast guard will probably rescue them. While in the Western Mediterranean the coast guards of Spain and Morocco cooperate closely, competences of the SAR actors in the Aegean Sea are divided quite clearly. We inform the boats about the consequences of an interception by coast guards from Turkey or Morocco: People will be brought back to their countries of departure. As we know that people will face the hell of deportation camps in Libya, we would never alert Libyan authorities - unless the boat people ask us to do so. If they wish to continue their journey, we wait before calling the responsible authorities.

*SL: Boat people send you their GPS locations, and you forward them to state authorities to raise alarm. Where does the Alarmphone come in?*

IF: The Alarmphone acts as a partial intermediary between boat people and state authorities, i.e. the coast guards in the different regions. As we sometimes experience that authorities listen more carefully to us than to boat people, this means giving the latter a voice or amplifying it. We are the only actor who not only calls the boat people back to ask for their current situation on board but also to calm them down in case of panic. We try to stay in touch with the boats during the rescue operation and even after it has ended. To be in direct communication enables us to learn about sudden changes on the boat: On 15 April 2017, for example, we were informed about a boat in distress in the Central Mediterranean. We spoke to the boat people over a period of more than 12 hours, before we lost contact. The engine did not work and water was entering the boat. We passed on their demands for rescue and updated their GPS positions to the responsible authorities and supported them throughout this difficult time. As weather conditions were fine, the simultaneous departure of dozens of boats from the Libyan coasts were quite frequent those days, while only one Frontex vessel was on duty. That Easter weekend, 8,360 people were rescued mainly by civil society rescue organisations. We scandalised the EU's responsibility in the construction of this deadly void at sea via social media – Facebook and Twitter –, press releases and in cooperation with the involved NGO-vessels. We always inform institutions like UNHCR by default about all of our cases, and we contact journalists and organisations in the relevant regions. We are careful in our decision whether to raise public alarm, though. Beforehand, we try our best to urge the responsible authorities to act by calling them repeatedly and by publishing current emergency cases via social media.

*SL: How do you maintain a critical perspective towards state practices in the Mediterranean in the long run?*

IF: Our overall aim is to abolish (national) borders and migration control. We do not consider ourselves an additional service provider to the coast guards but rather supporters of people who claim their right to freedom of movement. We publish critical statements about the current situation in the Mediterranean and

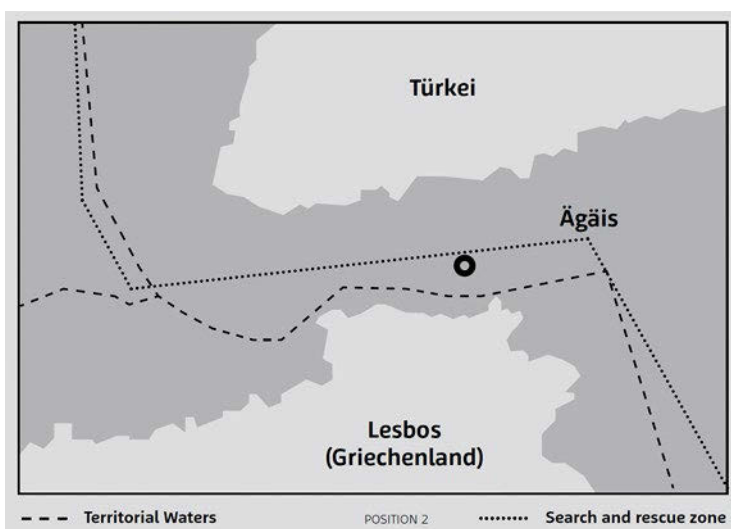
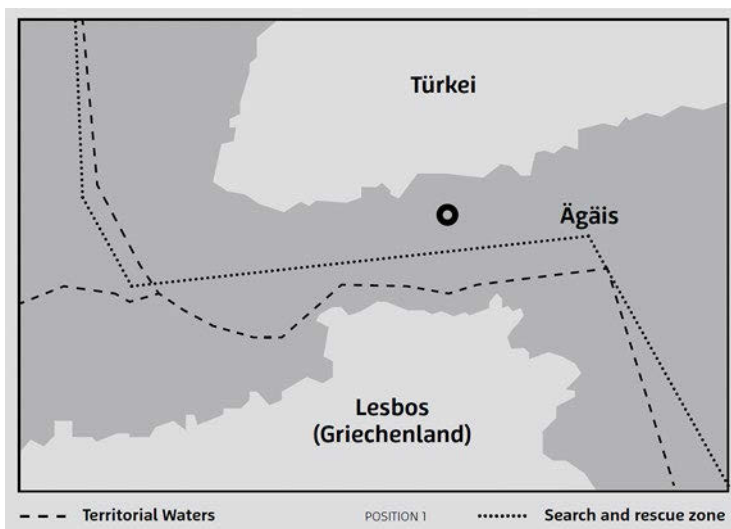



new developments on a regular basis. We scandalise the measures of the European Union and Frontex to build and extend the fortress of Europe while claiming to fight smugglers and human trafficking. We are convinced that only open borders will put an end to the smuggling business and all the calculated deaths at sea, as they depend on borders and illegal migration. In our work, we experience every day how closely the worsening of the conditions of flight is related to each time the migration regime gets tighter. However, we are happy about every boat that reaches its intended destination, although we are aware that crossing the Mediterranean Sea is only one small step towards a safe life in dignity.

*SL: Maps are often criticised as always transmitting some political perspective. Why is it important for you to appropriate official maps and conventions, and how do they serve your goals?*

IF: Official conventions define national borders and responsibilities. They frame the work of the actors, like coast guards and SAR vessels, as well as our own work. We fight for open borders and freedom of movement for all. In order to support people in distress, knowledge about a boat's current position in relation to borderlines and rescue zones is crucial. This way, we can assess whether human rights were violated by illegal state activities. The map of watchthemed.net is special: It not only displays borders defined by states, but also places of catastrophes and fatalities. If you look at the map, you see many large red spots. The numbers inside indicate the amount of reports in a specific region, so you can immediately detect the deadliest areas and migration routes of the Mediterranean.

*SL: There are many discussions centering around participation and democratic decision-making in crowd-maps. How do boat people participate in the Alarmphone?*

IF: The Alarmphone network consists of about 150 activists around the Mediterranean Sea who regularly do telephone shifts and/or contribute to the project otherwise. Some of our members have made the experience of crossing the Sea by boat themselves. Now they are doing shifts to support other people's crossings or contribute otherwise. Some of us live in Morocco or Tunisia, which enables these members to do follow-ups of cases – another important part of our work. For example, if people are sent back illegally and arrested, they establish contact with the arrested or their friends and families in order to find out what happened. Some migrants finally decide to come to Europe, where we can welcome them. The Alarmphone also offers advice regarding safety at sea via different kinds of social media in many languages. All our work is based strongly on the experiences of people who were boat people at a particular moment of their lives.

*SL: Thank you for the conversation.*

IF: Thank you.

## Closing Remarks: Rethinking Cartographic Critique

The Alarmphone is a particularly interesting example, as its everyday work revolves around the appropriation of diverse maps, digital tools and cartographic conventions. When receiving an emergency call, this socio-material infrastructure allows the Alarmphone teams to predict the outcome of actions they may take. To jointly make decisions, the Alarmphone and the boat people may establish and maintain communication in a way that is "imperceptible" (Papadopoulos et al., 2008: 214) to coast guards and border patrols. Communicating and mapping in real time thus become acts of subversion when they make it possible to identify human rights abuses and small holes in the European border regime apparatus and turn them into an immediate improvement of the boat peoples' situation.

The example of the Alarmphone offers new possibilities of describing cartographic critique. Moments of subversion are not to be found in reinterpretations of cartographic conventions; rather, they can be identified in the appropriation of maps and conventions and their combination with other digital tools. Within these complex assemblages, maps become a kind of organising tool for the flow of data, bodies and boats and they help to identify the necessary means and moments of subversive interventions (Cobarrubias & Pickles, 2009). Instead of a negative critique, these everyday cartographies positively enable alternative geographical imaginations. Instead of rejecting cartographic norms, the Alarmphone activists use digital mapping platforms and their underlying essentialisms to gain temporary authorship over the territorial borders of Europe.

### Endnotes

1. The name has been changed so that Ina can speak more openly about her experiences with the Alarmphone, and to prevent possible criminalisation.
2. [forensic-architecture.org/forensic-oceanography-addendum-report-left-die-boat/](http://forensic-architecture.org/forensic-oceanography-addendum-report-left-die-boat/)

### References

- Alarmphone 2014. For a 'Watch the Med – Alarmphone' for Boatpeople. [alarmphone.org/en/call](http://alarmphone.org/en/call), 12 January 2017.
- Alarmphone 2016. Moving On. One Year Alarmphone. [alarmphone.org/pt/intros/moving-on-6](http://alarmphone.org/pt/intros/moving-on-6), 13 January 2018.
- Heller, C. & Pezzani, L. 2014. Case: 'Left-to-Die Boat'. In *Forensic Architecture, ed. Forensis. The Architecture of Public Truth*. Berlin: Sternberg Press: 637-656.
- Kasperek, B. & Speer, M. 2017. Of Hope. Ungarn und der Lange Sommer der Migration. [bordermonitoring.eu/ungarn/2015/09/of-hope](http://bordermonitoring.eu/ungarn/2015/09/of-hope), 12 January 2017.
- Map Mos Maiorum 2014. Closing Statement: Documenting Racist Controls with Mapping Software. [map.nadir.org/ushahidi/page/index/8](http://map.nadir.org/ushahidi/page/index/8) 12, January 2017.
- Monroy, M. 2017. Staatsanwaltschaft Ermittelt gegen Refugee-Konvoi und Fluchthilfe-Webseite. [cilip.de/2015/11/06/staatsanwaltschaft-ermittelt-gegen-refugee-konvoi-und-fluchthilfe-webseite](http://cilip.de/2015/11/06/staatsanwaltschaft-ermittelt-gegen-refugee-konvoi-und-fluchthilfe-webseite), 12 January 2017.

### Illustrations

Map: Screenshot of watchthemed.net with red dots showing the number of cases in each region and with red-lined search and rescue zones.

Photograph on previous spread by Leona Goldstein: Two Alarmphone members during shift work.

Graphic on previous spread by Watch the Med: Model of the drifting "left-to-die-boat".

Graphics on opposite page by Alarmphone: A boat that has been localised and contextualised via the mapping platform watchthemed.net within international territorial demarcations.



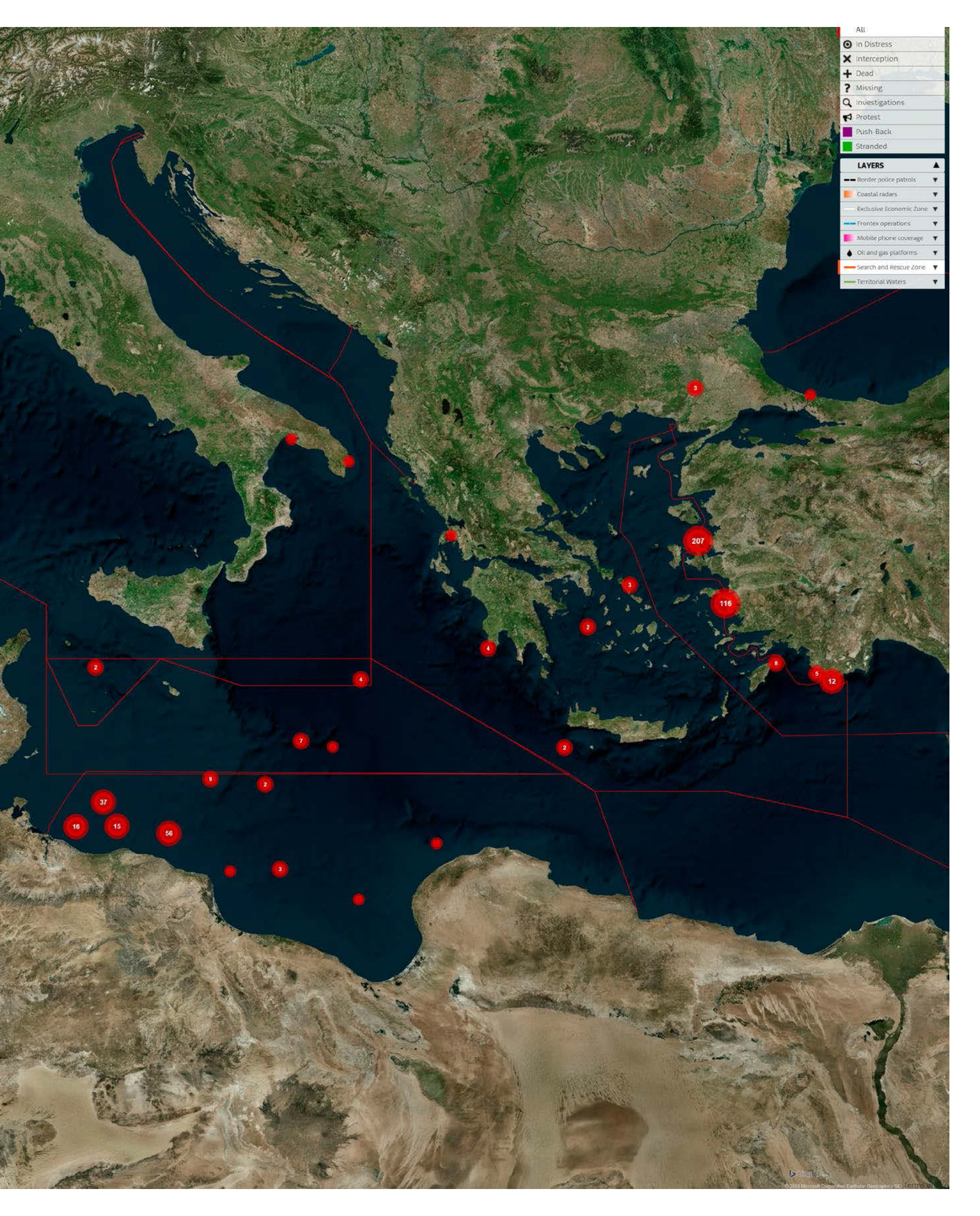

All

- In Distress
- Interception
- Dead
- Missing
- Investigations
- Protest
- Push-Back
- Stranded

**LAYERS**

- Border police patrols
- Coastal radars
- Exclusive Economic Zone
- Frontex operations
- Mobile phone coverage
- Oil and gas platforms
- Search and Rescue Zone
- Territorial Waters

37  
16  
15  
56

207  
116

12

# Militarization of Rio de Janeiro's Favelas

Measuring Impacts on the Lives of Young Black Men and Women through Social Cartography

Fórum de Juventudes do Rio de Janeiro<sup>1</sup>

facebook: Fórum de Juventudes do Rio de Janeiro

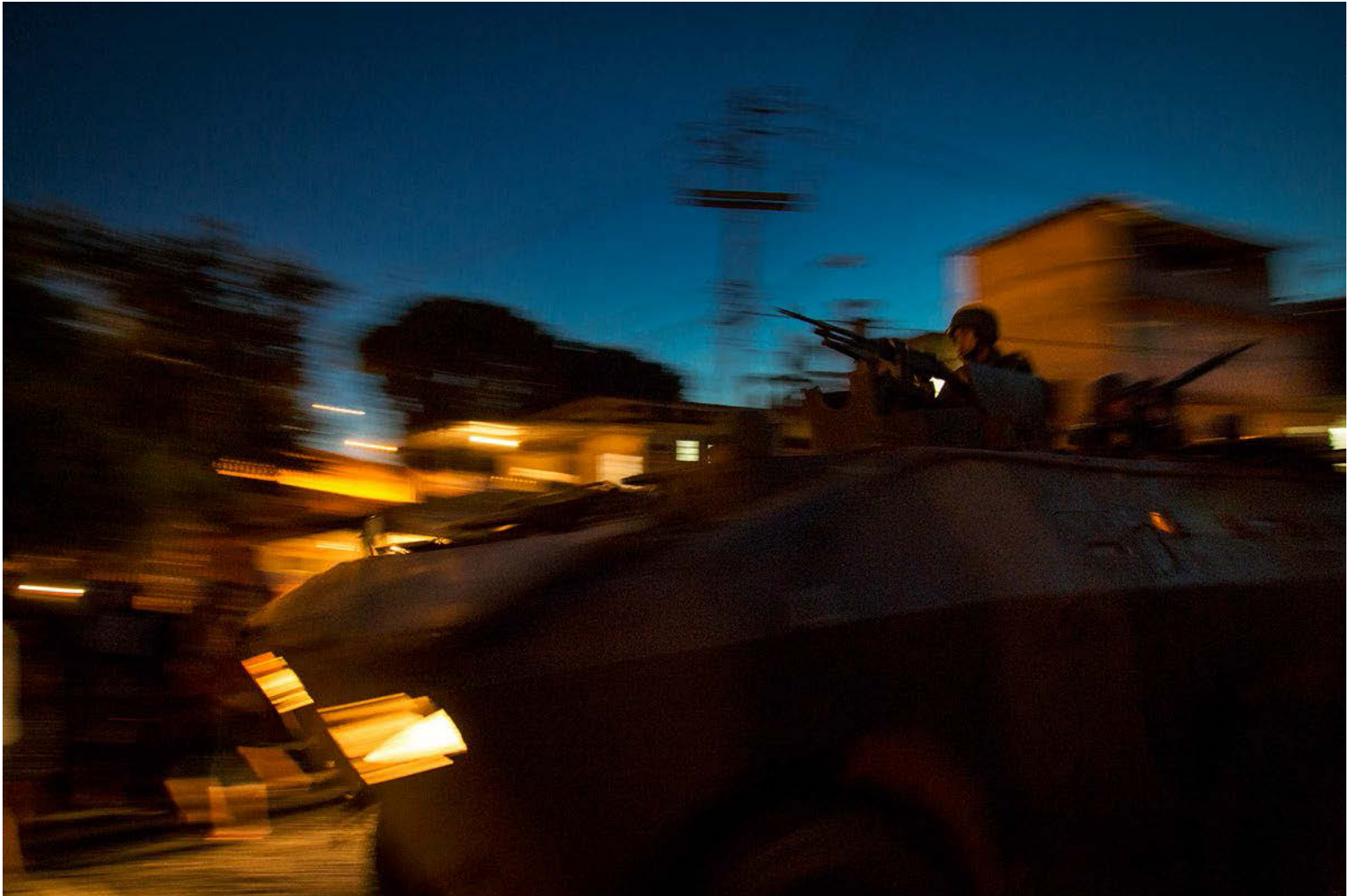

A young woman, identified only as Carolina, was going to school when the police raided her house. Grassroots communicators were violently prevented from doing their work and recording police operations in the favelas occupied by the Pacifying Police Unit (UPP) in Rio de Janeiro, which is a sign of the criminalization of social movements and dictatorial control of territories. Children play in fear of the noise coming from the helicopter of BOPE, Rio de Janeiro's military police special operation unit. This is a special battalion of the police force known for its brutal methods and interventions in the favelas. Its symbol and main instrument are, respectively, a skull and an armoured black vehicle called *caveirão* (which literally means "big skull"). Claudia Ferreira was shot in Morro da Congonha, and her body was dragged by the police in a case that shocked the city in 2014. Since then, dozens of other young residents from the favelas and peripheries have been killed by police officers, making fear a common feeling in places where the State presence through militarization has become yet another form of institutional violence. All these cases were mapped out as part of the project "Militarization of the Favelas: The Impacts on the Lives of Young Black Men and Women of the Youth Forum of Rio de Janeiro", held in 15 favelas of the state of Rio de Janeiro: Maré, Complexo do Alemão, Manguinhos, Jacarezinho, Rocinha, Vidigal, Santa Marta, Vila Kennedy, Providência, São Jorge/Campo Grande and Acari, all in the city of Rio de Janeiro, as well as Santo Cristo in Niteroi, São Bernardo in Belford Roxo, Jardim Primavera in Duque de Caxias and Engenho in Itaguaí.

The project was based on the social cartography methodology so that participants were able to develop ways of identifying, mapping and georeferencing rights violations committed mainly by the State against residents of the favelas and peripheries in Rio, in which black people make up the majority of the population. In total, 153 young people participated throughout the course of the entire project. Through speeches, illustrations and debates, the project was able to emphasize the institutionalized racism and war logic that constitute the State presence in these territories.

In this context, social cartography was chosen as an instrument of struggle by the Youth Forum of Rio de Janeiro. The Youth Forum represents a space in which young people, predominantly black residents of the favelas and peripheral neighbourhoods, can speak up in order to confront the genocide of black youth, institutionalized racism, violence against women, homophobia, lesbophobia, and transphobia.

Therefore, the objective of this project was to map out violations that go far beyond the geographical aspects traditionally being made visible. The use of social cartography aimed at breaking an imposed silence on local narratives about the impact of militarization in the lives of the favela residents. The project's participants were young black men and women between the ages of 14 and 29 years, which represents the age group most affected by violence. In Brazil, young black people are 2.5 times more likely to be murdered than young white people. This data is from 2015 and was published by the Brazilian Forum on Public Security, in cooperation with UNESCO and the National Secretariat for Youth. Unlike in a Democratic State of Law, violence in the favelas is not an exception to the rule. According to the Institute of Public Security, which reports to the Secretariat of Security of

Rio 497 (or 77%) of the 644 people killed as a result of police actions in the state of Rio de Janeiro in 2015 were black or dark-skinned. However, it is important to note that, although high, this number still does not correspond to reality since one major problem is the underreporting of cases.



## Method

The first step of the project was to hold workshops in the many participating favelas. The people responsible for the workshops were local partners and members of the Youth Forum who were trained on the New Social Cartography of the Amazon methodology and acted as facilitators. These are residents of favelas and peripheries that, for years, have been immersed in and actively contributing to urban debates on the genocide of black youth and other rights violations. On the basis of this engagement, the Youth Forum proposed the following themes for discussion in the social cartography: institutional racism, the right to the city and the very mapping constructions.

The project's supporters promoted the workshops. Each workshop was conducted in order to foster an open dialogue on the issues mentioned above. The goal was to stimulate the debate and interventions as part of the cartography construction process, which would be carried out by the young people involved. Each theme was explored in an open debate in discussion groups. The first step was to facilitate the free expression of participants, who were able to use various forms of communication to present their views, experiences, and ideas to change this reality.

Each workshop had its specific goals and themes, but all of them were conducted in accordance with the proposal to deconstruct the word "map". At each meeting the articulators first worked on the concept of "map" that young people had had in their mind until then. After that the notion of map was presented as something that is also built from a particular perspective and from the daily experiences of those who will use it to express themselves. The methodology followed was the New Social Cartography of the Amazon, one of the main subject references in the Latin American Region, especially in Brazil.

After the first moments of debate and open dialogue, the participants were invited to illustrate their own favelas through drawings, comics, speeches and other forms of expression. The experience showed that different kinds of expressions complemented each other. What might have been overlooked in certain kinds of speech was manifested through drawings, debates, music and so on. Some of the participants identified mostly with drawings, cartoons and collages. At the same time there were those who preferred to express themselves through musical styles, photographs, videos, etc. The project opened itself up to all of these communication tools which, throughout the process, were used as recording methods.

Gradually the favelas revealed themselves on paper, with elements that are usually overlooked and hidden within traditional maps. These included such things as the local youth gathering venues, the courts where parties, soirees and debates are held, football fields, day care centres and schools. Those are all elements that are often invisible in the favela representations created by outsiders. The maps also showed NGOs working in the favelas and places where people meet commonly. At the same time, the participants also pointed out drug trading spots; the favela access points where the police often carry out degrading searches, making people feel violated on a daily basis, places where women suffered violence, homes raided by UPP officers and so on.

The objective was to collectively build another geographical perspective that would also work as the basis for the affirmation and claim of rights. After that the material was assembled in a final project report.

### Next Steps

After the initial gathering of information, the project is at the stage of building a virtual geo-referenced database of the themes and situations exposed during the process described. The first result is a mobile phone app for denouncing the different forms of police violence which people in the favelas and peripheries of Rio de Janeiro suffer from. Created by the Youth Forum of Rio de Janeiro, and based on the social cartographic project, the app #NósporNós (meaning "by Us for Us") can be downloaded by anyone using a smartphone (via Playstore).

The app went live in March of 2016 and has already registered over 138 complaints. The most common complaints are the abuse of power, invasions of homes, torture and racism. The app has a support network composed of the Centre for Human Rights of the Public Defender's Office of Rio de Janeiro State, the Public Ministry and NGOs such as Global Justice, Amnesty International and IBASE. Complaints are forwarded to the relevant bodies. The purpose of the app is simple: Anyone can submit a violation of rights occurring in the city. The purpose is to map out the amount of rights violations carried out by the State and to also understand the nature of these actions. Thus, people are free to detail the violations as much as they want. In addition, some cases are beginning to be sent directly to the Public Ministry of Rio de Janeiro, which will have the responsibility of defining a possible investigation. It is worth mentioning that the Brazilian Human Rights Fund supported the creation of the application, which facilitated the initial communication and dissemination. As a result, during the first 6 months an average of one to three complaints arrived per day via the app. While all of these were reported to the Public Ministry, the immense workload of the Youth Forum prevented the representation of all of them in the map of the application. After this initial phase and with the expiration of the support of the Human Rights Fund, it became difficult to continue promoting the app, which resulted in a decrease of denunciations.

The general feeling is that from now on the social cartography method has entered the routine of the Youth Forum of Rio de Janeiro as a new fighting tool for the favela residents of the city.

*Translation by Rodrigo Calvet and Ana Luiza Lopes*

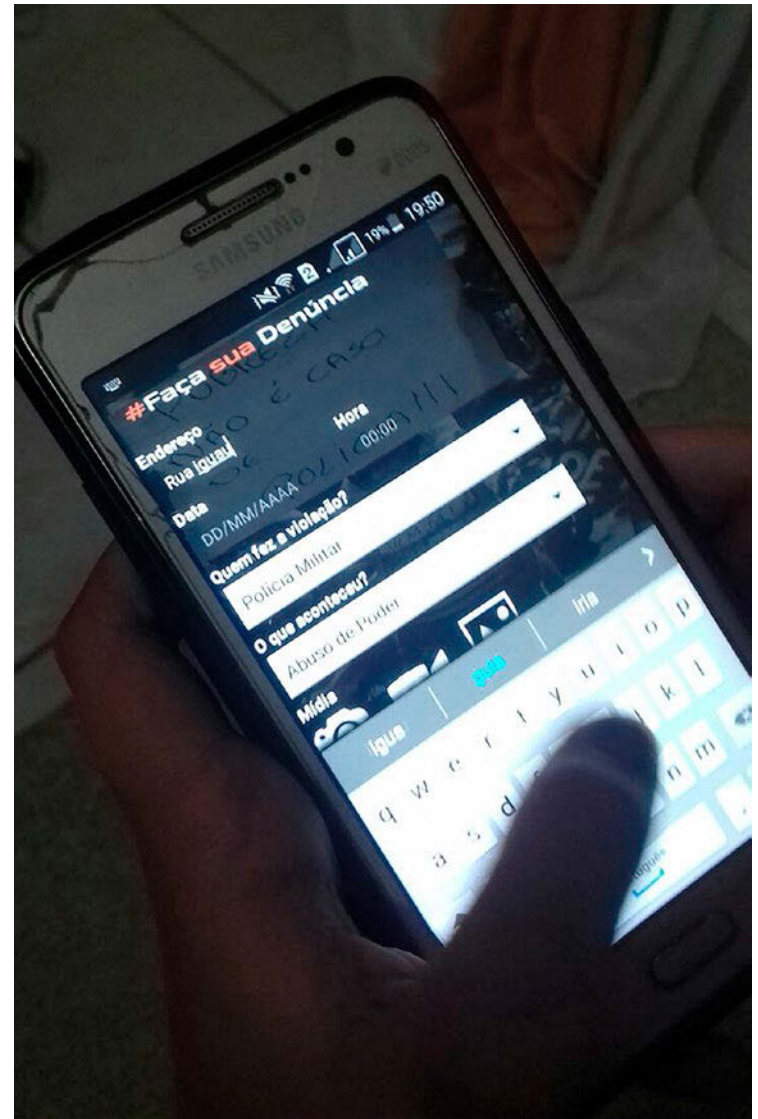

### Endnotes

1. Text by Fransérgio Goulart, Marina Ribeiro, Leticia Maione and Camila Nobrega.

### Illustrations

Photograph previous spread by Luiz Baltar

Illustration previous spread by Youth Forum of Rio de Janeiro: logo of the mobile phone app "NósporNós"

Photograph this page by Youth Forum of Rio de Janeiro: using NósporNós

Photograph opposite page by Luiz Baltar

Map by Youth Forum of Rio de Janeiro



Camada sem título

- ABUSO DE PODER, TORTURA E RACISMO
- ABUSO DE PODER, MACHISMO, RACIS...
- ABUSO DE PODER, TORTURA, RACISMO....
- ABUSO DE PODER, AMEAÇA DE AGRES...
- Machismo, abuso de poder e violência c...
- Abuso de Poder
- Invasão de domicílio
- Abuso de poder
- Abuso de poder
- Abuso de Poder
- Invasão de Domicílio e abuso de poder
- Abuso de poder
- Abuso de Poder e ameaça
- Tortura
- Abuso de poder
- Homicídio
- Homicídio
- Invasão de Domicílio
- Invasão Domicílio
- Abuso de Poder

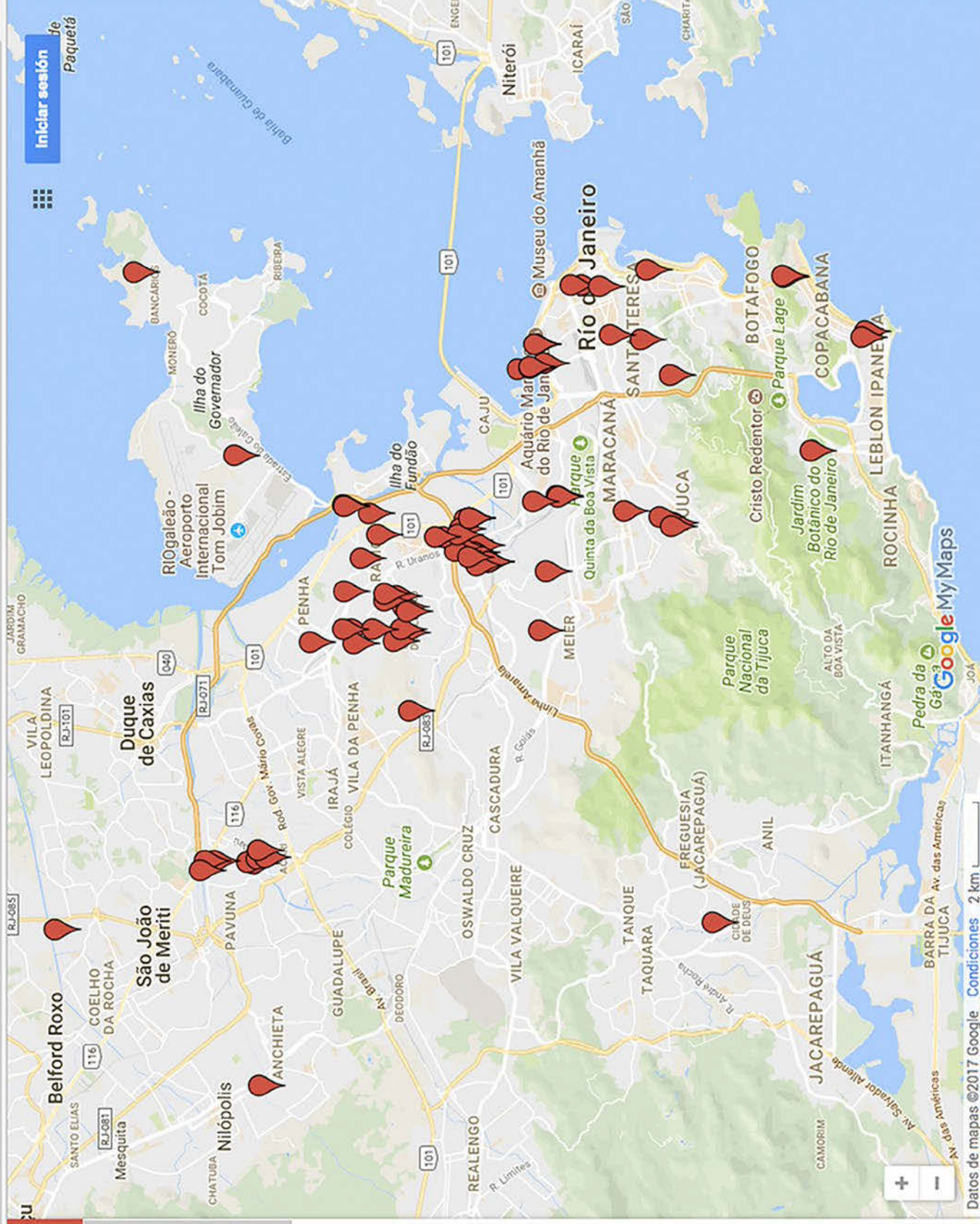



## Invasão de Domicílio e abu...

nome

Invasão de Domicílio e abuso de poder

descrição

dia 26 de março  
Edgar Severiano, Engenho da Rainha  
"com a morte da criança por bala perdida no cajueiro e as manifestações dos moradores,os policiais do 9 batalhão estão entrando nas casas dos moradores sem mandato com objetivo de oprimir a população."  
morador(Anônimo)

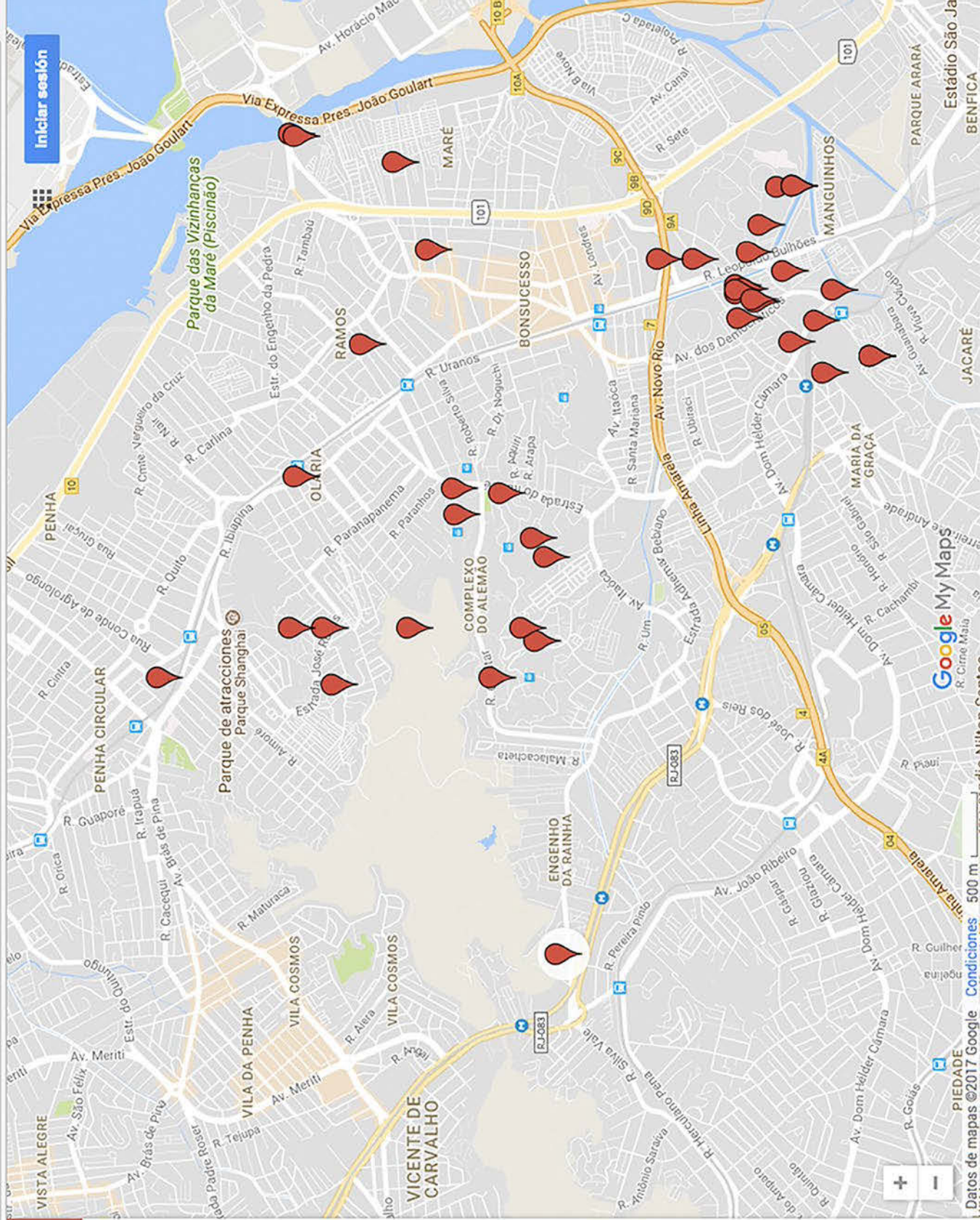

Iniciar sessão



Google My Maps

Datos de mapas ©2017 Google Condiciones 500 m

# Political Action Maps

Finding your Way in Demonstrations and Protests

Kartographische Aktion  
[aktionskarten.noblogs.org](http://aktionskarten.noblogs.org)



Social movements often take place in public space: during demonstrations and other political actions people move along streets, paths and sometimes cross-country. Often, when we want to reach places, we are denied entrance. And only rarely do we have the opportunity to protest on familiar terrain close to our homes. Thus, the need for maps focusing on protest becomes obvious.

Especially during protests which aim to achieve more than just walking along a police-approved demo-route, independent and spontaneous orientation is essential. In Germany, for example, there are regularly recurring protests for the purpose of stopping Nazi demonstrations, demonstrating against ecologically destructive surface mining or to disturbing the transport of atomic waste. Often the concept of the protest is to decentralize and to carry out different actions in different places at the same time. Participating groups and individuals can either rely on others and follow along – or they can organize themselves independently and hereby create a more powerful protest.

In order to achieve this kind of autonomy, you will need a political action map. Such a map shows important contact points, landmarks, demo-routes and protests in their surrounding area. If, during a protest, up-to-date information is broadcast via live ticker, cellphone, smartphone or radio, this information can be referenced on the map. This way, ideally everybody knows where they have to go. Additionally, useful infrastructure can be included on the map: Is there a store somewhere close by? Where is the closest public toilet? In case of serious confrontations, the locations of pharmacies and hospitals are useful. If available, other information like live ticker websites or phone numbers of information hotlines, street medics and legal aid services, etc., could also be provided in a corner of the map.

### Political Action Maps in Practice Distribution and Creation

Political action maps are often used in demonstrations and protests in Germany – we don't know about the situation elsewhere (please tell us if you do). Some of these maps are made by Kartographische Aktion. Organizers of protests contact us, explaining that they could use a map, and we provide one for them, as a kind of demonstration service, so to speak, just like there are collectives for loudspeaker vans or protest medics. The organizers print the maps themselves and distribute them on-site. Most of the maps are also made available online for self-printing. We regularly provide maps for the groups we are in close contact with. Others have seen our maps during a protest and have contacted us for their next event. During the last six years we have created about 90 maps, mainly for anti-fascist protests, but also for anti-capitalist as well as ecological and feminist event days. Thus, creating maps has become a part of our political work. We support others with whatever we can contribute. This also works over a distance, which is especially useful for groups in remote and rural areas that would normally receive less outside support than urban



movements. So far we have had to decline only few requests and only because it was impossible to make a map on time.

But how do you go about creating such a map? Most of our maps are made on the basis of OpenStreetMap (OSM), a free online map or rather a map database. At least in central Europe, the map data has such a high quality that it outperforms even the official maps. There are dedicated programs that enable you to make "normal" maps from OSM-Data which are in turn enriched with additional information through image editing programs. Over the last years we have standardized and optimized our sequence and written scripts to automate certain steps. This has reduced our workload immensely: While having needed up to two days working on a (bad) map previously, today some maps require only two to three hours of work. And they have become much better along the way.

This steady and "functional" approach probably also explains why the maps appear so simple and look so much alike. They all have the same set of rather neutral-looking icons, symbols and markings. The style is a compromise between the technical feasibility of presenting as much graphical information as possible on a small, reasonably priced and handy piece of paper without covering important information, such as street names or markings. Who knows what might become relevant on the streets later on? Some people only need the layout of big streets while others want to know the quickest way to get through an array of garden plots or which shortcuts and beaten tracks are available. All in all, the map follows the model of traditional city maps.

### The Maps of the Future Decentralized and in Real Time?

Meanwhile, we have begun efforts to enable others to create their own political action maps. Decentralization, distribution of skills and self-determination always lead to improvement. The means and tools of map-making are increasingly available for free. Technological hurdles are being lowered and becoming less and less of a problem for more and more people over time. That is why we have published some instructions for making political action maps on our blog.

At this point, the emancipatory potential of free software and geodata developed in the last years is becoming apparent. Only a few years ago, creating your own maps was simply not feasible in Germany, especially for rural regions. The coverage of OSM-Data was initially so patchy that for a functional map it was simply unusable. Instead, proprietary and inflexible topographic maps had to be utilized. In other regions of the planet, OSM provides the first possibility whatsoever to get access to useful map material. With growing coverage, more and more possibilities arise to make use of the data for one's own purposes.

With a growing proliferation of online applications, smartphones and mobile internet, the question arises: What could political action maps look like in the future? There are already



**E**  
**F**  
**G**  
**H**  
**I**  
**K**  
**L**  
**M**  
**N**  
**O**  
**P**

5 6 7 8 9 10 11 12 13

**Nazi Rally Starting Point**  
(Main Station, 5 p.m.)

**Vigils and Info Points**

**Events and Counter Actions**

**More Infos at:**  
[www.stralsundnazifrei.rockgegenrechts.com](http://www.stralsundnazifrei.rockgegenrechts.com)

**Stralsund**

**KNIEPER**

**HAFENINSEL**

**ALTSTADT**

"Festival of Colors"  
(5 p.m., Bürgergarten)

"Nazifrei und Spaß  
dabei" Family Festival  
(from 5 p.m., Food & Drinks)

Historical City Walk  
(3:30 p.m., Alter Markt 7)

Nazi Route

Intended

5 6 7 8 9 10 11 12 13

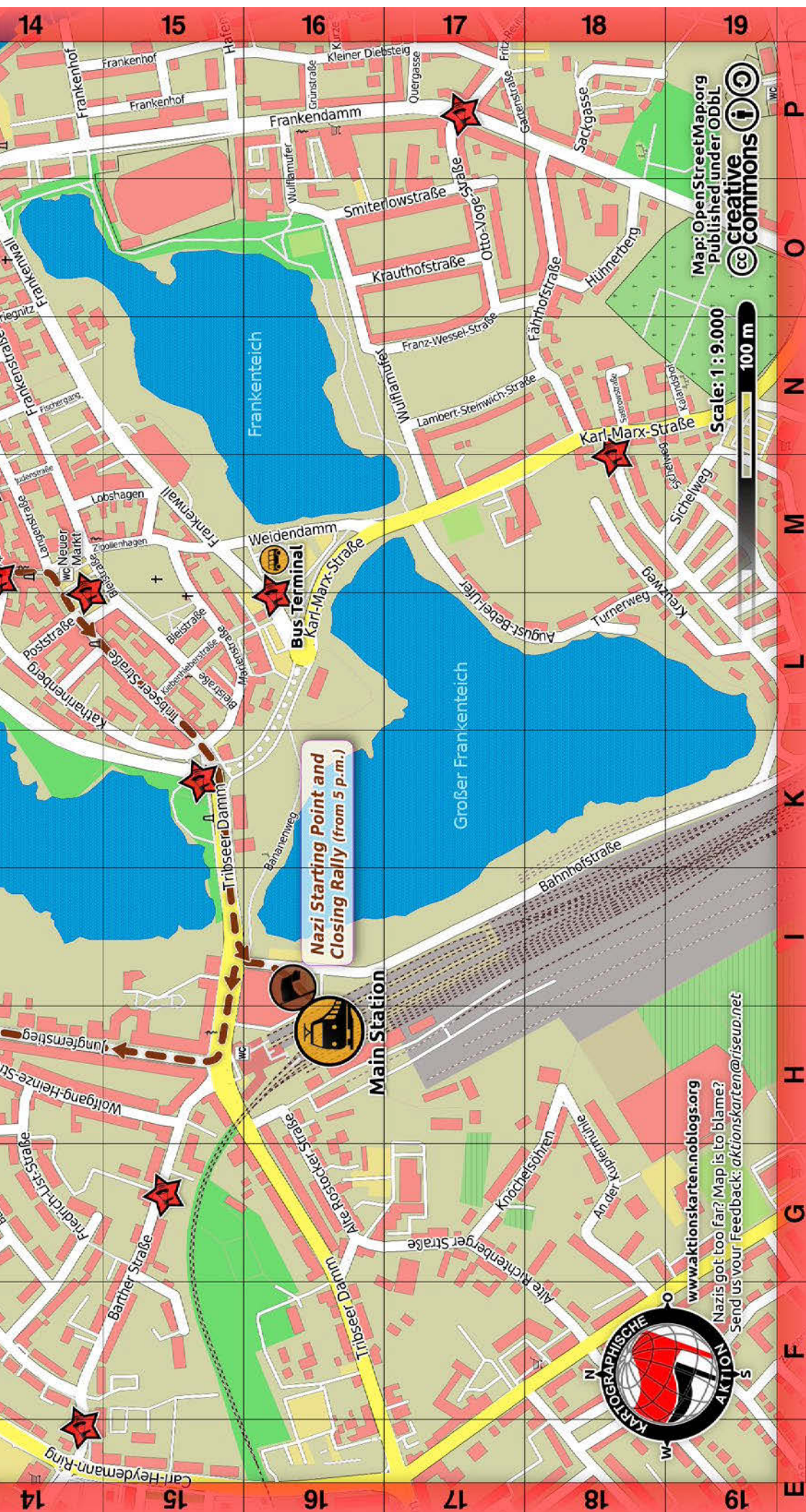

approaches and attempts to work with digital live maps that cover the ongoing situation during protests on the smartphone. In some actions, for example, the map crowdsourcing tool Ushahidi is used, by means of which many people can independently add information to a map. In Berlin, the app Gegen Nazis was developed, which illustrates the routes of Neo-Nazis and counter-protests for a few demonstrations. There is still great potential in this field, but a general development is on the horizon: The dynamic of such situations could be portrayed much better in live maps. These could help making the current situation more distinguishable and allow for a more spontaneous reaction.

Upgraded police units also utilize such systems to control or suppress protest events. This and a number of other new problems have to be considered. The authorities can, for example, try to use internal protest communication for their own purposes. The widespread use of cell phones and smartphones is already being utilized by law enforcement agencies to gather information about the protests and their participants. In Germany, cases have been made known in which the police have investigated identities of people in proximity to protest marches, have gathered detailed call records as well as created movement profiles and gathered the contents of cell phone communication. If protests are made to depend on mobile devices, this also facilitates the possibilities of surveillance for the authorities. Moreover, participative, dynamic maps could be manipulated (e.g. by the police or other participating groups) or used to predict the movements of protesters.

Nonetheless, political action maps remain an emancipatory means to support protests – on paper or on screen. The future will show us yet more and easier ways to enable everybody to orientate themselves in public spaces during protests.

**Create maps and use them to make change!**

*Translation by koriander*

**Illustrations**

Map by Kartographische Aktion. Special thanks to the OSM contributors.

This map was originally published in German and has been translated for its publication here.

# This Land Is Your Land

Strategies for Making the Potential Commons Visible and Actionable

596 Acres – Paula Z. Segal, Mara Kravitz

596acres.org

**YOU'VE FOUND THE LOT IN YOUR LIFE**

**NOW WHAT?**

**WORK WITH YOUR LOCAL GOVERNMENT**

*Research the lot.*  
GO TO THE MAP AT 596ACRES.ORG AND TALK TO YOUR NEIGHBORS

CALL OR EMAIL THE OWNER.  
GO TO 596ACRES.ORG FOR A SCRIPT TO HELP WITH YOUR CONVERSATION FIRST. ASK IF THERE'S A PLAN, & IF SO, ASK WHY IT HASN'T HAPPENED.

*CONTACT 596 ACRES & TELL US HOW YOUR CONVERSATION WENT*  
WE'LL HELP YOU FIGURE OUT WHAT THE ANSWERS YOU GOT ACTUALLY MEAN.

**BUILD A RECORD OF SUPPORT**  
GET LETTERS FROM LOCAL & CITY ORGANIZATIONS LIKE THE COMMUNITY BOARD & THE BOROUGH PRESIDENT'S OFFICE

*Share your vision*  
PRESENT YOUR PLAN TO ALL THE STAKEHOLDERS. THIS INCLUDES THE COMMUNITY BOARD, YOUR CITY COUNCIL REP, THE DISTRICT LEADER, & THE PEOPLE IN THE NEIGHBORHOOD, OF COURSE.

**THIS MIGHT TAKE A LONG TIME AND YOU MIGHT HAVE TO TALK TO A LOT OF DIFFERENT PEOPLE IN N.Y.C. GOVERNMENT.**

**WORK WITHIN YOUR COMMUNITY**

*Learn from other groups*  
596 acres meeting

**FIND OUT WHO OWNS THE LOT**  
IT COULD BE PRIVATELY-OWNED OR OWNED BY ONE OF 16 GOVERNMENT AGENCIES.

*Draw pictures share them in a meeting*

**GET SOME PRESS**  
WORK WITH A JOURNALIST YOU TRUST

**GET IT OUT THERE**  
DISTRIBUTE FLYERS...

*Meet regularly*

**RAISE MONEY**  
USE 108Y.ORG. THEY ARE FRIENDS OF 596 ACRES AND A NON-PROFIT. THEY ARE SET UP TO BE YOUR FISCAL SPONSOR - AND HAVE A NICE WEBSITE FOR RAISING MONEY ONLINE. IT'S EASY.

**GET INSURANCE**  
596 ACRES CAN HELP YOU GET INSURANCE FOR FREE.

**CONNECT WITH EXISTING GROUPS IN YOUR NEIGHBORHOOD**  
THIS INCLUDES BLOCK ASSOCIATIONS, CHURCHES, & COMMUNITY BOARDS.  
KEEP THIS DIALOGUE GOING.

*Put it on the map*  
GO TO 596ACRES.ORG & LET EVERYBODY KNOW YOU WANT TO DO SOMETHING.

**GIVE YOURSELVES A NAME**  
YOU HAVE TO START TO BUILD A RECORD OF YOUR ORGANIZATIONS

*Identify a shared vision*  
WRITE A MISSION STATEMENT

**MEET MORE PEOPLE IN YOUR HOOD. GET THEIR NAMES, ADDRESSES, AND CONTACT INFO.**

**PREPARE TO USE THE SPACE**  
FIGURE OUT WHAT YOUR GROUP IS GOING TO DO IN THE SPACE FIRST & MAKE SPECIFIC PLANS. A WORK PARTY PERHAPS...

**start a petition**

**IT'S NOT ALWAYS A STRAIGHT LINE. IF YOU NEED HELP CONTACT 596 ACRES AT ANY TIME.**

**596 ACRES.ORG**

**GET THE KEY grow something!**

DESIGN BY HANNAH LEARNER - HLEARNER2@GMAIL.COM

## Identifying Objects to Be Considered<sup>1</sup>

To shape the dreams and demands of people living in cities yearning for collaborative creative spaces in which to fulfill the needs of their communities, we start by mapping government-owned land and buildings. Our maps show the abundant potential of our shared spaces hiding in plain sight, aching for collaborative management and care. We then connect those maps with tools and strategies understandable to residents of the places we have drawn. We put up signs, we answer the phone, we provide scripts, examples and a community of collaboration. The maps are the starting place for the emergence of true commons to replace warehoused public real estate assets.

There are approximately 660 acres of vacant public land in New York City, distributed across 1,800 vacant lots (596 Acres, 2016). These lots could be gardens, play spaces and sites of community gathering and cultural activity. Located primarily in low-income communities of color, these potential public spaces sit vacant, locked and forgotten, abscesses in the very neighborhoods that most need healthy resources. These gaps only compound a history of redlining, urban renewal clearance and municipal neglect.

As New York City's community land access program, 596 Acres helps neighbors organize around and gain access to the city's vacant land. We combine sophisticated online tools and grassroots outreach to turn municipal data into information useful to the public, help neighbors navigate city politics and connect neighborhood organizers to one another through social networking and in-person collaboration. The 596 Acres model is driven by a belief in data-driven, inclusive and democratic local power that is scalable to citywide and statewide issues around environmental justice and public space. In the last four years, through the information we have provided and our direct support, residents have replaced 36 vacant lots with vibrant community spaces.

## Mapping What Is Already Ours

The 596 Acres team started in 2011 by hunting down the available information about vacant city-owned land in New York City. We first had to rely on access to City data that was behind a paywall blocking it off from general public access via an academic center at a local college. Realizing that crucial information was being kept from the communities that needed it most, in 2012 we collaborated with other advocates to successfully pressure the City to release the data for free. We also comb the NYC Open Data portal and other city agency and non-profit organizations' records for information relevant to government-owned property in New York City.

We translate the data into information describing the world as New Yorkers actually experience it, beginning with the very definition of a "vacant" property. The NYC Department of City Planning lumps community gardens, slivers of lots between buildings, and actual publically-accessible vacant lots together under the same VACANT code. After using an automated script, a staff person looking at online records of each property and a survey of community gardens done by gardeners to untangle this, we are certain that our online map shows public land that is actually vacant lots a regular person would understand as being vacant: fenced, full of garbage and weeds and stray cats and discarded weapons (596 Acres, 2016).

The map goes a step further to connect these neglected spaces with the decisions that led to their present state and the decision-makers that have some power to change their future. Some of the decisions were made through a process of "urban renewal"<sup>2</sup> in the last century. Understanding that the urban renewal plans weigh heavily on what we see in our neighborhoods today but not being able to find data describing the plans in machine-readable form, we used New York State's Freedom of Information Law to request decades of planning documents that we read and then translated into data tables we can map and connect with particular properties.

## Open Data Becomes Open Space

The key to our success in transforming open data into community-managed open space is that we put information on the fences that surround vacant lots. The online map allows us to figure out what information to put on signs. Our signs announce clearly that the land is public and that neighbors, together, can work towards permission to transform the lot into a garden, park or farm. Both the online map and in-place signs list the city's parcel identifier, which agency has control over that property and information about the individual property manager handling the parcel for the agency.

Each group of residents must navigate a unique bureaucratic maze: applying for approval from the local Community Board, winning endorsement from local elected officials, and negotiating with whichever agency holds title to the land. The signs and the online map both connect organizers to the staff of 596 Acres, who steer and support residents through organizing support, legal advice and technical assistance.

We work with each unique situation to figure out what is possible and then help people achieve it: Often campaigns end in a permanent transfer to the NYC Parks Department, but sometimes a temporary space for a few years, until other planned development moves forward, is the only achievable outcome.

596 Acres acts in a supporting and advocacy role during each campaign but ultimately each space is managed autonomously, transformed and maintained by volunteer neighbors and local community partners as spaces to gather, grow food and play. Each one gives people an opportunity to shape the city, practice civic participation and self-government, and become co-creators with their fellow New Yorkers.

596 Acres facilitates neighbors building political power by connecting with one another. We do not remain abstracted on the internet or limited by only having face-to-face meetings. By bridging modalities, we have the ability to connect New Yorkers with different strengths and who represent different groups. Online, people can sign up to organize a particular local lot, and then receive updates when others sign up or post. The online tool helps neighbors connect even before getting access to an actual place to build together. However, not everybody we work with ever sees the online tool; many interact in person or over the phone with our staff and simply give us permission to add their information so others can find them.

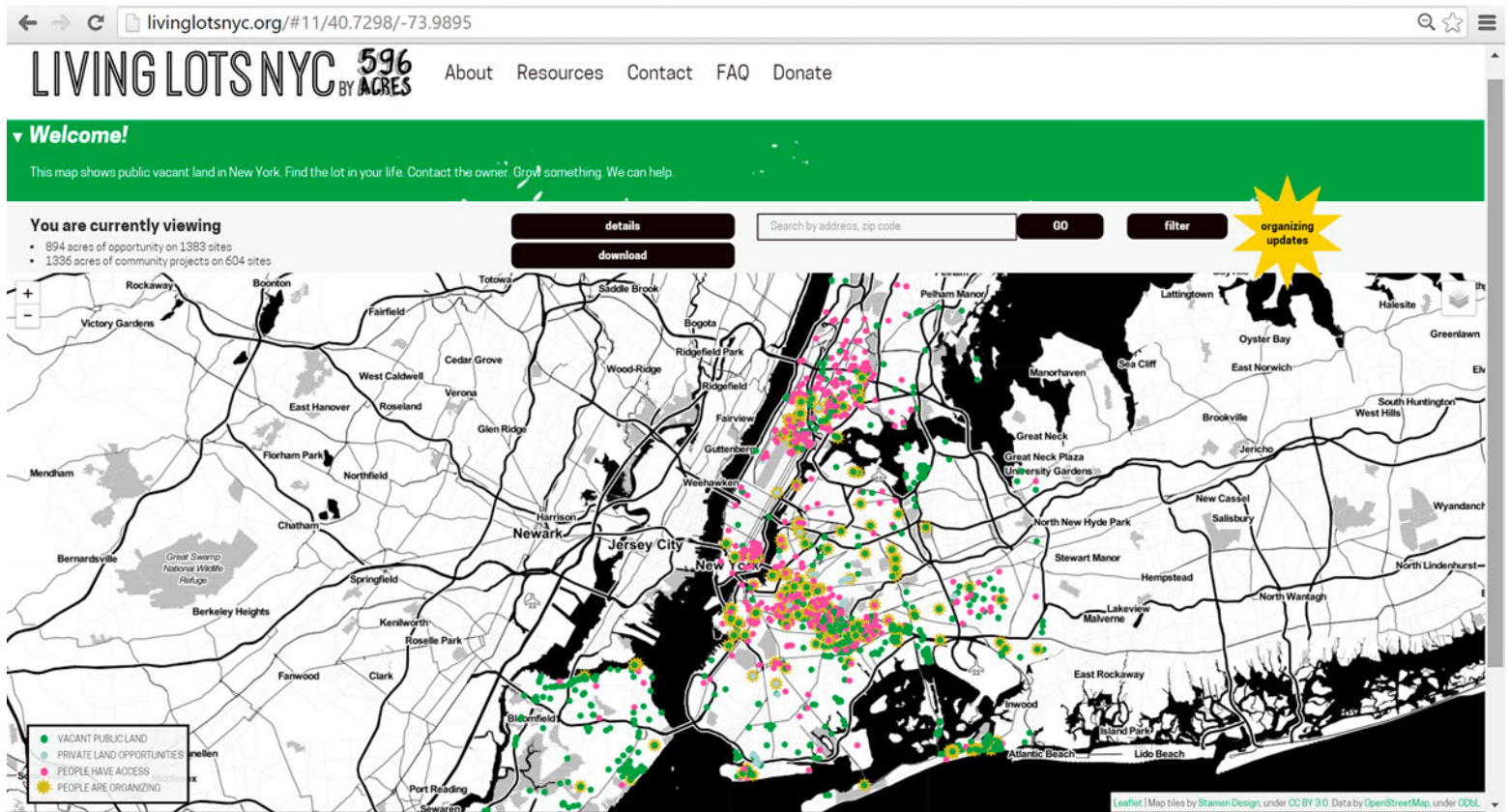

### Data in Action

While New York City politicians rhetorically prioritize urban agriculture and public space, 596 Acres actually fills the gap between place and the people in our neighborhoods. 596 Acres sees – and teaches others to see – empty spaces as sites of opportunity, both for potential green spaces in neighborhoods that lack them, and as focal points for community organizing and civic engagement.

In January 2015, when the City published a list of 181 "hard-to-develop" properties they were willing to sell for \$1 to housing developers to build pretty expensive housing, we analyzed the list and found out that it included 18 community gardens, six of which had formed through our support. We published a map and called the impacted gardeners, tapping into and expanding our network, while arming the impacted residents with the tools to advocate for the preservation of the existing community spaces (see map at the end of the article).

Within three weeks, over 150 New Yorkers, including four City Council members, rallied on the steps of City Hall (Tortorello, 2015). A year-long campaign followed. It included Community Planning Boards, City Council and advocates in every level of the administration. On 30 December 2015 the NYC Departments of Parks and Housing Preservation and Development agreed to permanently preserve fifteen of the gardens on the for-sale list; community pressure was so great that the announcement extended to community spaces that were not even on-offer to developers in January: In total, 36 community spaces were permanently preserved as a result of information-driven advocacy – the fourth wave of major garden preservation successes in NYC history.

### Beyond NYC's Vacant Lots

Bridging disposition strategies for public resources and the cooperative projects that emerge when these strategies result in community access to land interrupts the narrative of scarcity that permeates all conceptions of real estate and allows neighbors to collectively shape their cities. Strategies derived from the success of 596 Acres have emerged in nearly a dozen cities worldwide, including Los Angeles, Montreal and Melbourne (596 Acres, 2016). In Philadelphia the local incarnation, groundedinphilly.org, was a necessary precondition for the recognition of land stewards and urban agriculture practitioners as an existing constituency whose needs must be considered as that city creates a new protocol for the disposition of public land. Making the potential of abundant vacant public land visible, beginning with mapping, gets the most impacted people into the center of decision-making about our shared resources, inspiring tangible grassroots change well beyond the boundaries of neighborhood vacant lots.

The "Right to the City", as first articulated by Henri Lefebvre in 1968, recognizes the urban environment as a work of art constantly being made anew by its inhabitants, a space of encounter that allows differences to flourish and generates the contemporary conditions for creative human communities. The right to the city is the right to influence the urban environment that will, inevitably, shape those that spend their days in it. It is really a right to personal autonomy and community self-determination. Our maps are the gateway to the collective, creative acts that shape urban places. They make expressing the right to the city possible for everyday people.



BOROUGH BOROUGH

BLOCK BLOQUE

LOT(S) LOTE(S)

# THIS LAND IS YOUR LAND

ESTA TIERRA ES SU TIERRA

Want to learn more? You have options:  
¿Quieres saber más? Estas son tus opciones:

You can call the city agency that owns this lot to see if they have any plans for it:  
Usted puede llamar a la agencia de la ciudad que posee este lote para ver si tienen algún plan para él:

( ) -

You can call GreenThumb to ask them to talk to the city agency for you:  
Puede llamar a GreenThumb para pedirles que hablen con la agencia de la ciudad por usted:

(212) 788-8070

596 ACRES

Confused? Want more information on how this all works?  
¿Confundido? ¿Quieres más información sobre cómo funciona todo esto?

Call us at (Llámenos al):  
(718) 316-6092

or email (o escribanos al correo):  
organizers@596acres.org



## Endnotes

1. "Maps don't merely represent space, they shape arguments; they set discursive boundaries and identify objects to be considered." (Institute for Applied Autonomy, 2008)
2. In 1949 the United States Congress started a federal urban redevelopment program, or "urban renewal," which provided resources to municipal "blight clearance." Federal money was made available to local redevelopment authorities to buy and clear so-called "blighted" areas and then sell that land to private developers. The program followed federal redlining – which distributed access to loans for homeowners along explicitly racial lines – by a decade and was deployed in nearly the same neighborhoods as the ones that had been declared too integrated for safe investment in the housing stock. Urban renewal facilitated the clearance of neighborhoods in which people of different races lived side by side in American Cities between the World Wars.

## References

- 596 Acres. Living Lots NYC.  
livinglotsnyc.org, 4 February 2016.
- 596 Acres. Other Cities Copy.  
596acres.org/about/other-cities-copy, 14 January 2018.
- Institute for Applied Autonomy 2008. Tactical Cartographies. In Mogel, L. & Bhagat, A., eds. *An Atlas of Radical Cartography*. Journal of Aesthetics & Protest Press: 29-37. [cril.mitotedigital.org/node/352](http://cril.mitotedigital.org/node/352), 14 January 2018.
- Lefebvre, H. 1996. *Writings on Cities*. Oxford: Wiley-Blackwell.
- Tortorello, M. 2015. In Community Gardens, a New Weed? [nytimes.com/2015/02/12/garden/in-community-gardens-a-new-weed.html](http://nytimes.com/2015/02/12/garden/in-community-gardens-a-new-weed.html), 14 January 2018.

## Illustrations

Photograph this page top by Murray Cox: The Electric Ladybug Garden  
Photograph this page bottom by Murray Cox: The Free Black Women's Library

# QUEENS COMMUNITY DIST

## WATERFRONT ACCESS?

Block 16007 Lot 55

The North Shore Waterfront Conservancy of Staten Island worked with the NYC DOT Street Plaza Program to turn City-owned properties on their borough's waterfront turned over to Parks to be the first street plaza project to access tidal wetlands! This bayside DCAS lot on Beach 63rd could follow a similar path!

## A FUTURE JUICE BAR?

Block 15897 Lot 1

Alexis, who is working to create the garden on Beach 43rd and Rockaway Beach Boulevard, is interested in using this lot between the road and the elevated subway tracks to host a juice bar housed in a shipping container. Want to help her get started? Contact her at alexissmallwood83@gmail.com or 347-962-9537.

MAP DESIGN: JOSEPH LAGRAND



JUNE 2015

## CITY OWNED VACANT LAND

- NYC Dept. of Housing Preservation & Dev. (HPD)
- NYC Dept. of Citywide Admin. Services (DCAS)
- NYC Parks & Recreation
- NYC Dept. of Education
- NYC Dept. of Transportation
- NYC Dept. of Small Bus. Serv.

•••••	Cit
•••••	
■	Cor

DATA SOURCE: <http://livinglotsnyc.org/about/living-lots-nyc-data/>

# DISTRICT 14

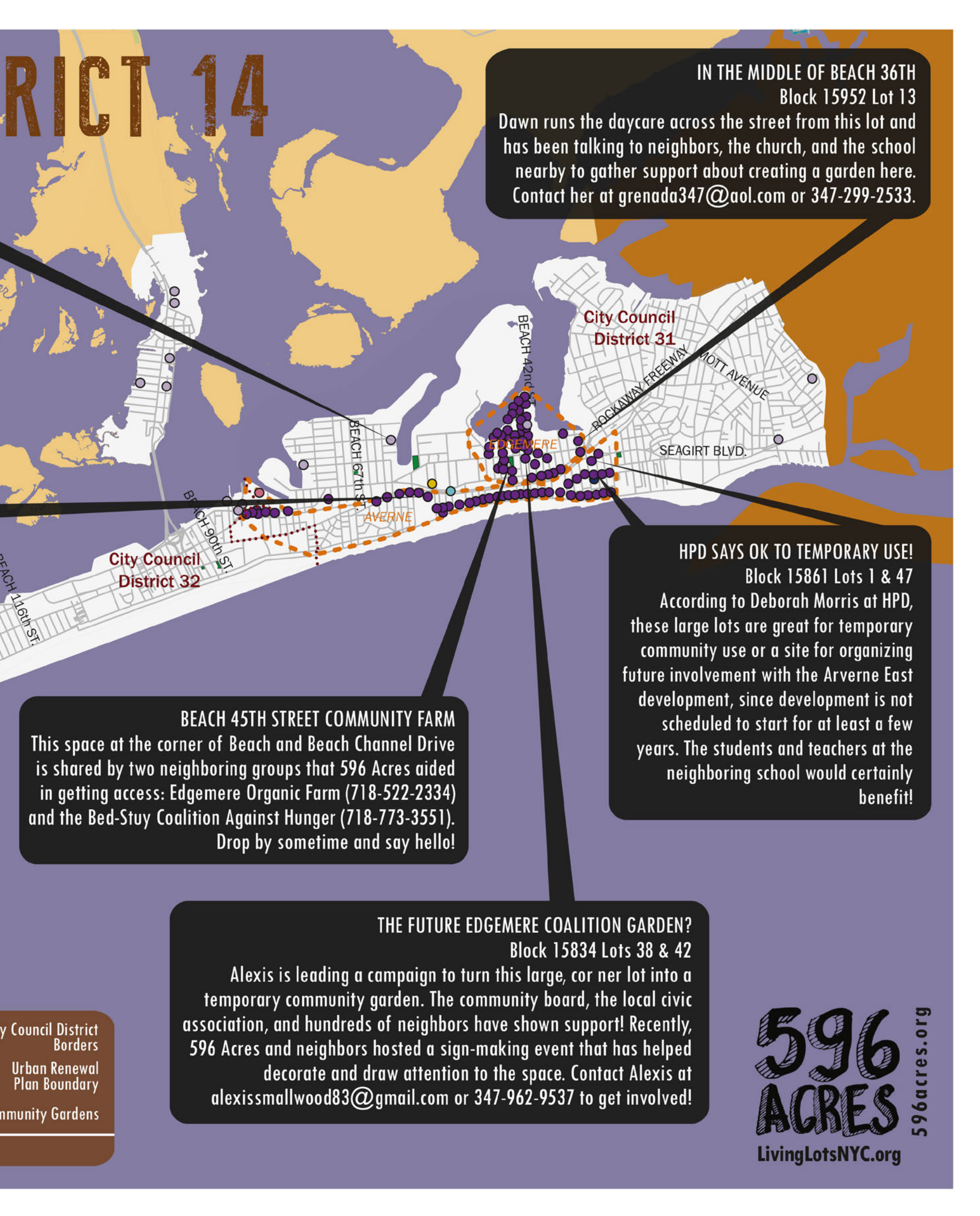

**IN THE MIDDLE OF BEACH 36TH**  
 Block 15952 Lot 13  
 Dawn runs the daycare across the street from this lot and has been talking to neighbors, the church, and the school nearby to gather support about creating a garden here. Contact her at [grenada347@aol.com](mailto:grenada347@aol.com) or 347-299-2533.

**HPD SAYS OK TO TEMPORARY USE!**  
 Block 15861 Lots 1 & 47  
 According to Deborah Morris at HPD, these large lots are great for temporary community use or a site for organizing future involvement with the Arverne East development, since development is not scheduled to start for at least a few years. The students and teachers at the neighboring school would certainly benefit!

**BEACH 45TH STREET COMMUNITY FARM**  
 This space at the corner of Beach and Beach Channel Drive is shared by two neighboring groups that 596 Acres aided in getting access: Edgemere Organic Farm (718-522-2334) and the Bed-Stuy Coalition Against Hunger (718-773-3551). Drop by sometime and say hello!

**THE FUTURE EDGEMERE COALITION GARDEN?**  
 Block 15834 Lots 38 & 42  
 Alexis is leading a campaign to turn this large, corner lot into a temporary community garden. The community board, the local civic association, and hundreds of neighbors have shown support! Recently, 596 Acres and neighbors hosted a sign-making event that has helped decorate and draw attention to the space. Contact Alexis at [alexissmallwood83@gmail.com](mailto:alexissmallwood83@gmail.com) or 347-962-9537 to get involved!

City Council District Borders  
 Urban Renewal Plan Boundary  
 Community Gardens

**596 ACRES**  
[596acres.org](http://596acres.org)  
[LivingLotsNYC.org](http://LivingLotsNYC.org)

# HPD SELECTS 18 GARDENS FOR POTENTIAL HOUSING DEVELOPMENT

Housing Preservation and Development (HPD) has requested proposals for housing from developers for 181 sites - 18 with active gardens on them

-  Vacant lots and gardens in HPD jurisdiction (Total: 964)
-  Vacant lots and gardens that HPD identified as potential development sites, New Infill Homeownership Opportunities Program and Neighborhood Construction Program Request For Qualifications (RFQ), Addendum 1, Jan. 14, 2015, <http://www.nyc.gov/html/hpd/html/developers/NIHOP-NCP-RFQ.shtml> (Total: 181)
-  Vacant lots not included in RFQ (Total: 783)
-  Gardens that HPD identified as potential development sites (Total: 18)





**596  
ACRES**

Map designed by Joseph LaGrand for 596 Acres. Copyright by Joseph LaGrand & 596 Acres, Inc. 2015. This work is licensed under the Creative Commons Attribution-NonCommercial-ShareAlike 4.0 International License. To view a copy of this license, visit <http://creativecommons.org/licenses/by-nc-sa/4.0/>



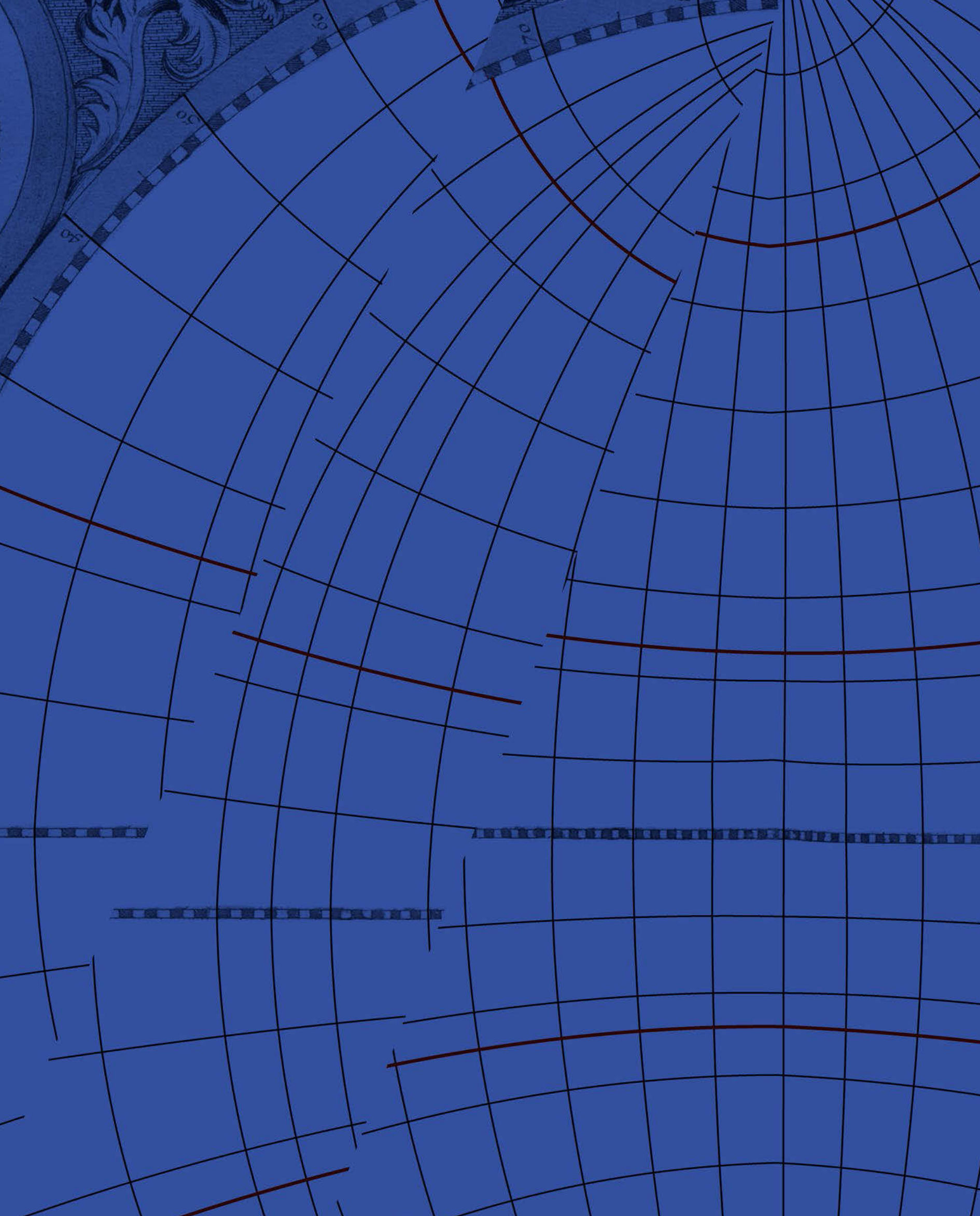

# Counter-Cartographies Tie Networks



# X-Ray of Soy Agribusiness in the Pampa and Mega-Mining in the Andes<sup>1</sup>

Iconoclastas – Julia Risler, Pablo Ares  
iconoclastas.net

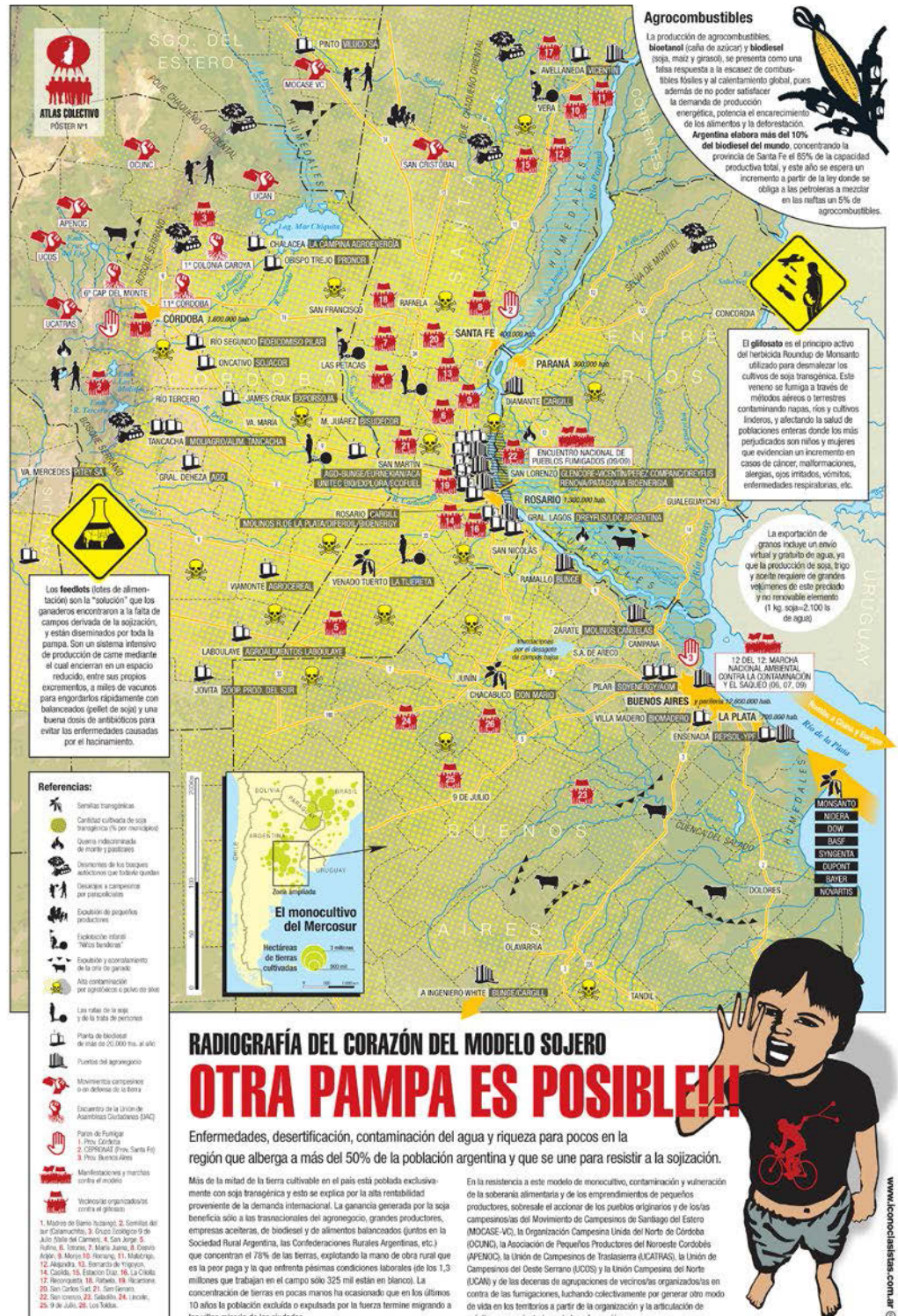



We are a duo formed in 2006. We combine graphic art, creative workshops and collective research to produce activist resources that can be circulated, used and appropriated freely. Through designing and carrying out workshops, we seek to strengthen the communication between activists, to set up networks of solidarity and affinity, and to promote collaborative practices of resistance and transformation. Through this dynamic web of affinity and solidarity, built by sharing and promoting open projects and collective workshops in Argentina, Latin America and Europe, our practice keeps on spreading.

We share our resources and practical experience on our website in order to not only set them free from barriers of private property but also from economic, physical and geographic restrictions. The website works as a multimedia support in order to spread and share the material we produce and to foster its appropriation through creative commons licenses. Resources uploaded to the web for reappropriation, reproduction and redefinition turn this virtual means into a collective tool through which hierarchies are dismantled and exchange is stimulated. In consequence, users become producers recurring to liberated production.

Creating resources for their free circulation as well as their particular drifts and reappropriations has transformed and broadened our practice. Constant exchange with and relations to other collectives, organizations and social movements has promoted a reciprocal influence encouraging us to incorporate new approaches, resources and topics. These have led us to rethink the way in which materials circulate, how strategies spread and how we engage in collective constructions. This political, affective and creative network gave way to itinerant exhibitions, collaborative creation workshops, new ludic resources and the participation in meetings with cultural organizations and social movements.

### **About the Maps**

Between 2008 and 2010 we travelled across Argentina, setting up workshops in various cities of different provinces by contacting university students as well as cultural and communicational groups. In these spaces topics for collective reflection emerged. They were thoroughly analyzed and expanded when we participated in the 10<sup>th</sup> and 11<sup>th</sup> session of the Citizen Assemblies Union (UAC) in Jujuy and Córdoba, as well as in four meetings organized by the popular education collective Pañuelos en Rebelión in Bariloche, Tucumán, El Dorado (Misiones) and in Ciudad del Este (Paraguay). During these sessions and meetings a heterogeneous group of social movements, social and environmental assemblies, organizations of peasants and native peoples, neighbors and citizens for the defense of common goods participated in creating accounts, marking situations and rendering visible the various types of organization and resistance of communities. During the first two days of the sessions in Jujuy we assembled a booth displaying maps and cards so that participants could approach the desk to share their knowledge about conflicts and resistances taking place within the different regions in Argentina. During the third and last day a map was presented. This map was systematized and depicted the following question: Keeping in mind that we were designing a map to be circulated in public, should we also depict the resistances and achievements of organizations? This dilemma was

positively resolved in a second session in Córdoba when dozens of representatives of assemblies and communities, after having corrected and verified data, voted on the importance of rendering visible resistances in the maps of the public domain by a show of hands. After the systematization of these meetings two major issues were identified:

### **The Model of Agribusiness and the Consequences to Transgenic Monoculture**

A complex issue, which emerged in the workshops organized in the city of Córdoba, Rosario (Santa Fe) and the districts of Morón, La Plata, San Andrés de Giles, Olavarría, Tandil and Bahía Blanca, among others. These mappings revealed a type of agricultural production concentrated within a few hands and produced with a technological package consisting of machines, transgenic seeds, herbicides and highly toxic and polluting pesticides (see map on opposite page).

### **Open Pit Mega-Mining**

This topic in particular emerged during the workshops organized in districts close to the Andes. In this case mappings evidenced the business of multinational corporations (primarily Chinese and Canadian companies) and the ways in which they penetrate districts, are poorly regulated by the State and are tolerated by the political branch. The mappings furthermore revealed the types of exploitation in mountain areas and the separation of minerals through a toxic process using big amounts of water, polluting air and water, damaging landscapes and ecosystems and harming the rights and the health of inhabitants and communities (see map at the end of the article).

### **"The Map Is Not the Territory"<sup>2</sup>**

When we talk about local territories, we don't just mean the physical space in which we find ourselves, but also the social body and rebel subjectivities. Mapmaking is one of the principal tools employed by the dominant powers to appropriate territories for utilitarian purposes. This happens not just as a form of spatial planning but also to set borders that define new occupations and plan strategies of invasion, plunder and appropriation of communal property. As such, the maps commonly circulating in our societies are based on a vision that is imposed onto territories by the dominant powers in order to create hegemonic representations of space. These are functional to the development of the capitalist model, rationally decoding the land, classifying natural resources, demographic characteristics and the type of production that can most effectively transform labor power and resources into capital.

But the map is not the territory. A connection with a particular territory is established through processes of interpretation, feelings and personal experiences. Maps are not the territory because they are unable to account for the subjectivity of the territorial processes, symbolic representations and imaginations inherent to them and the constant mutability and changes they are subject to.



### In that Case, Why Work with Maps?

To harness a tool that enables us to collectively create critical narratives and in order to share inputs for the creation of emancipatory practices. In the workshops we use tools that allow us to collectively create complex scenarios, deepen critical approaches and encourage alert and active subjectivities. These are essential if we are to protect common property, fight against processes of colonization and privatization of the public sphere, and establish new worlds.

### Maps as Part of an Ever-Moving Collective Process

We shouldn't forget that maps are tools that capture a snapshot of a particular moment, but they cannot completely describe the complex, problematic territorial reality that they are based on. Rather, a map transmits a particular collective idea of a dynamic and ever-changing territory in which the real and symbolic borders are constantly affected by the perceptions and actions of bodies and subjectivities. Maps have to be part of a bigger process, one of many strategies, a means to foster thinking, to socialize knowledge and practices, to boost collective participation, to work with strangers, to swap experiences, to challenge hegemonic spaces, to promote creation and imagination, to probe specific issues, to visualize resistances and to point out power relationships...

### Endnotes

1. Parts of this text appeared as "Iconoclastas. Critical mapping, collaborative practices and open source graphic resources" online ([de.scribd.com/document/202343141/Iconoclastas-Critical-mapping-collaborative-practices-and-open-source-graphic-resources](https://de.scribd.com/document/202343141/Iconoclastas-Critical-mapping-collaborative-practices-and-open-source-graphic-resources)) This article and all its illustrations are licensed under a Creative Commons Attribution-NonCommercial-ShareAlike 4.0 License (CC BY-NC-SA 4.0).
2. This phrase is attributed to Alfred Korzybski (a Polish aristocrat and founder of general semantics), who apparently coined it after his experience as an officer in World War I, when he led a disastrous attack in which his soldiers ended up falling into a pit that was not marked on the map. Gregory Bateson (a North American anthropologist and linguist) completed the phrase by adding "and the name is not the thing named." What they both sought to express was the impossibility of objectifying the significant, emotional dimensions of spaces and linguistic representations.

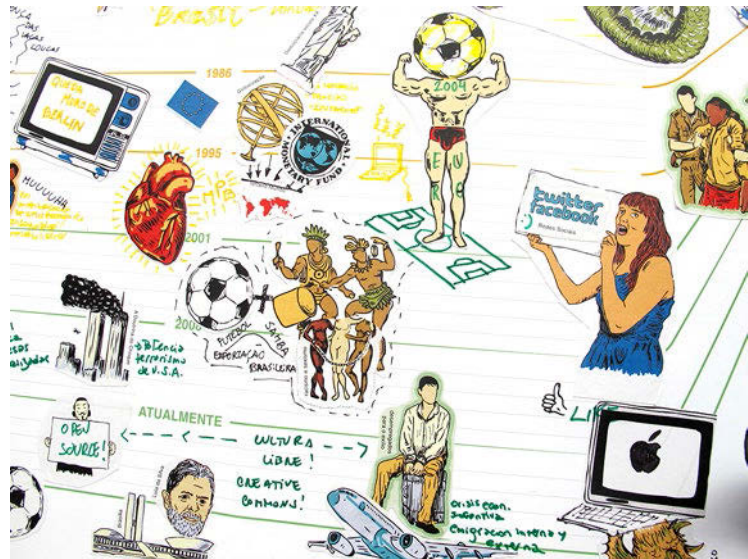
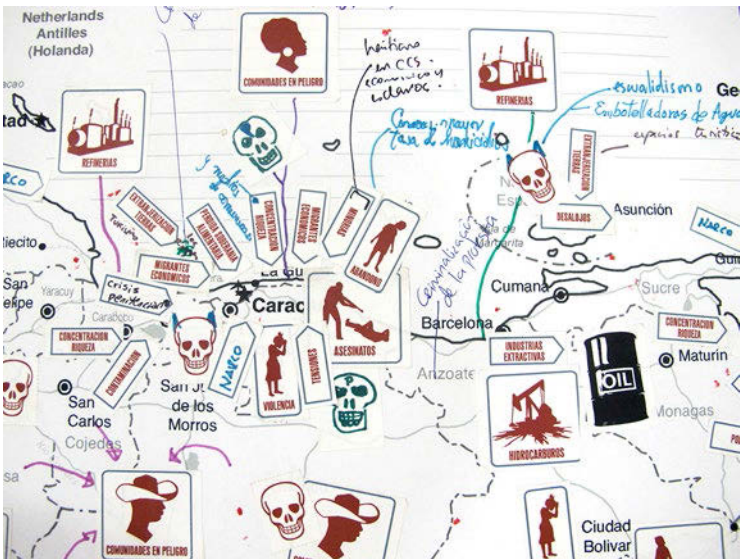

### Alarm Bells

The realization of a large-scale mining project happens in various stages. Be on the alert!

#### 1. Project

The mining company begins to negotiate with local governments.

1 TO 3 YEARS

#### 2. Exploration and installation

They do major drilling and begin to construct the infrastructure.

DECADES UNTIL THE SEAM IS EXHAUSTED

#### 3. Exploitation and processing

Commercial phase: They break apart mountains and separate minerals from the rock using toxic chemicals.

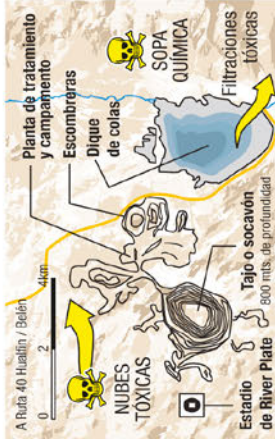

### The Alumbrella Mine

Among the world's "top ten" polluters

**Belén, Catamarca.** It uses 100 million liters of water daily from the Campo de Arenal aquifer, as well as highly polluting flocculents, detergents, frothers & xanthates. All of the waste materials end up in a tailings dam, which has leaks. Explosions used to clear rock send tons of particulates into the atmosphere, creating artificial clouds and causing major alterations in the biosphere.

## MEGA-MINING IN THE DRY ANDES

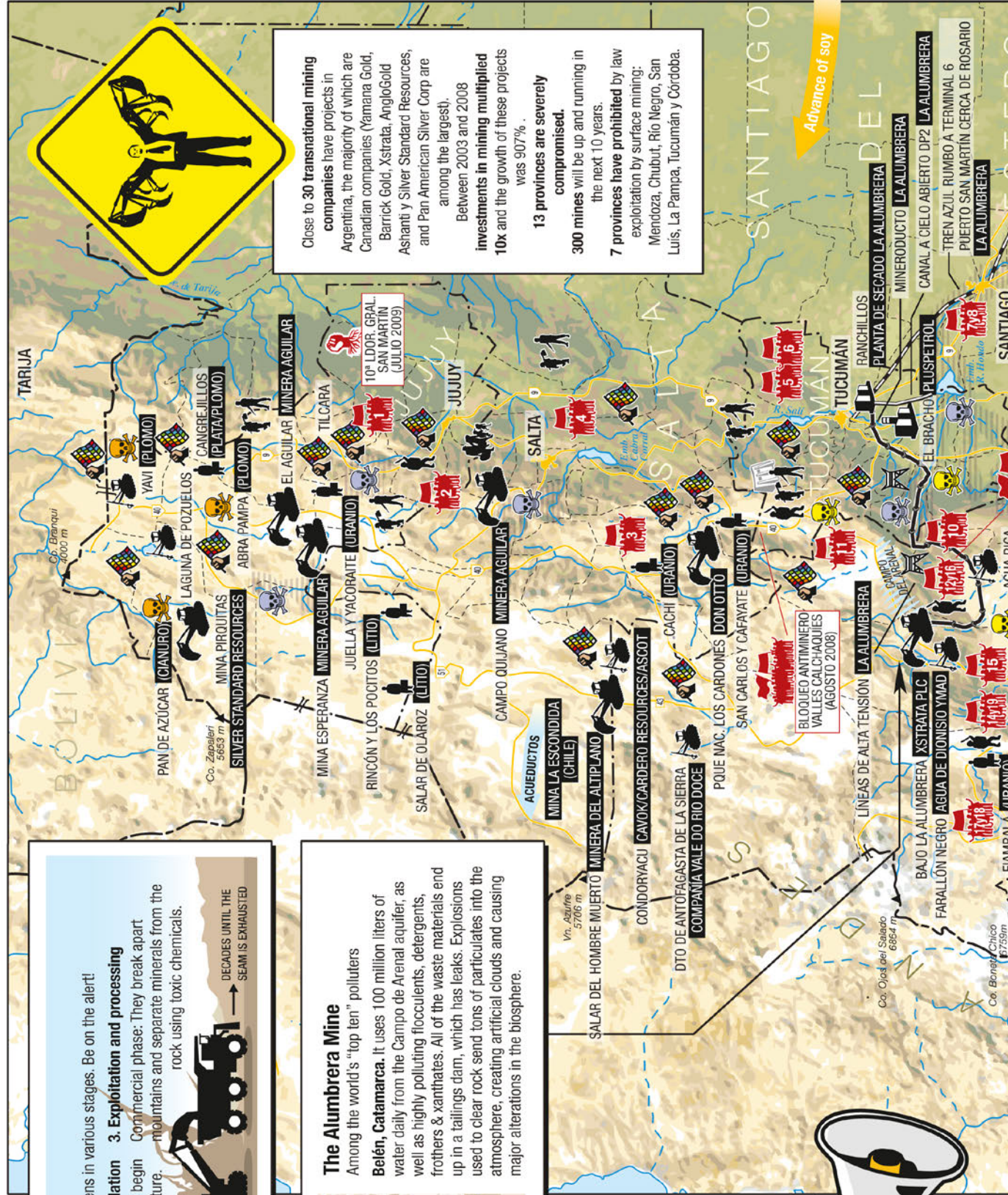

Close to 30 transnational mining companies have projects in Argentina, the majority of which are Canadian companies (Yamana Gold, Barrick Gold, Xstrata, AngloGold Ashanti y Silver Standard Resources, and Pan American Silver Corp are among the largest).  
Between 2003 and 2008 investments in mining multiplied 10x and the growth of these projects was 907%.

13 provinces are severely compromised.  
300 mines will be up and running in the next 10 years.  
7 provinces have prohibited by law exploitation by surface mining: Mendoza, Chubut, Río Negro, San Luis, La Pampa, Tucumán y Córdoba.

Advance of soy

# NOT FOR ALL THE GOLD IN THE WORLD!

Surface mining uses excessive amounts of water and energy, destroys territories, and directly affects the health and ways of life of their inhabitants.

Transnational mining companies have enjoyed government subsidies and legal stability for over 30 years; state and local fiscal incentives mean these companies pay minimal withholdings to move valuable metals out of the country, doing so with only a simple vow and without state oversight. They are also allowed to leave 100% of their profits from these transactions outside Argentina. The implementation of this model of looting -- extraction and export -- has been resisted by residents, campesino communities, social organizations, indigenous Kolla and Diaguita peoples, and concerned neighbors organized in social-environmental assemblies for the defense of life and land. These groups use various strategies of struggle and denunciation when faced with the damages wrought by these mega-mining projects.

Local governments argue that mining will bring "development and work" when the facts demonstrate that they only generate sickness, destruction and death. These governments assist the onslaught of transnational mining companies with repressive politics that criminalize and penalize protest and by supporting the action of quasi-official "special groups" charged with intervening violently against anti-mining marches or blockades with the aim of silencing resistance.

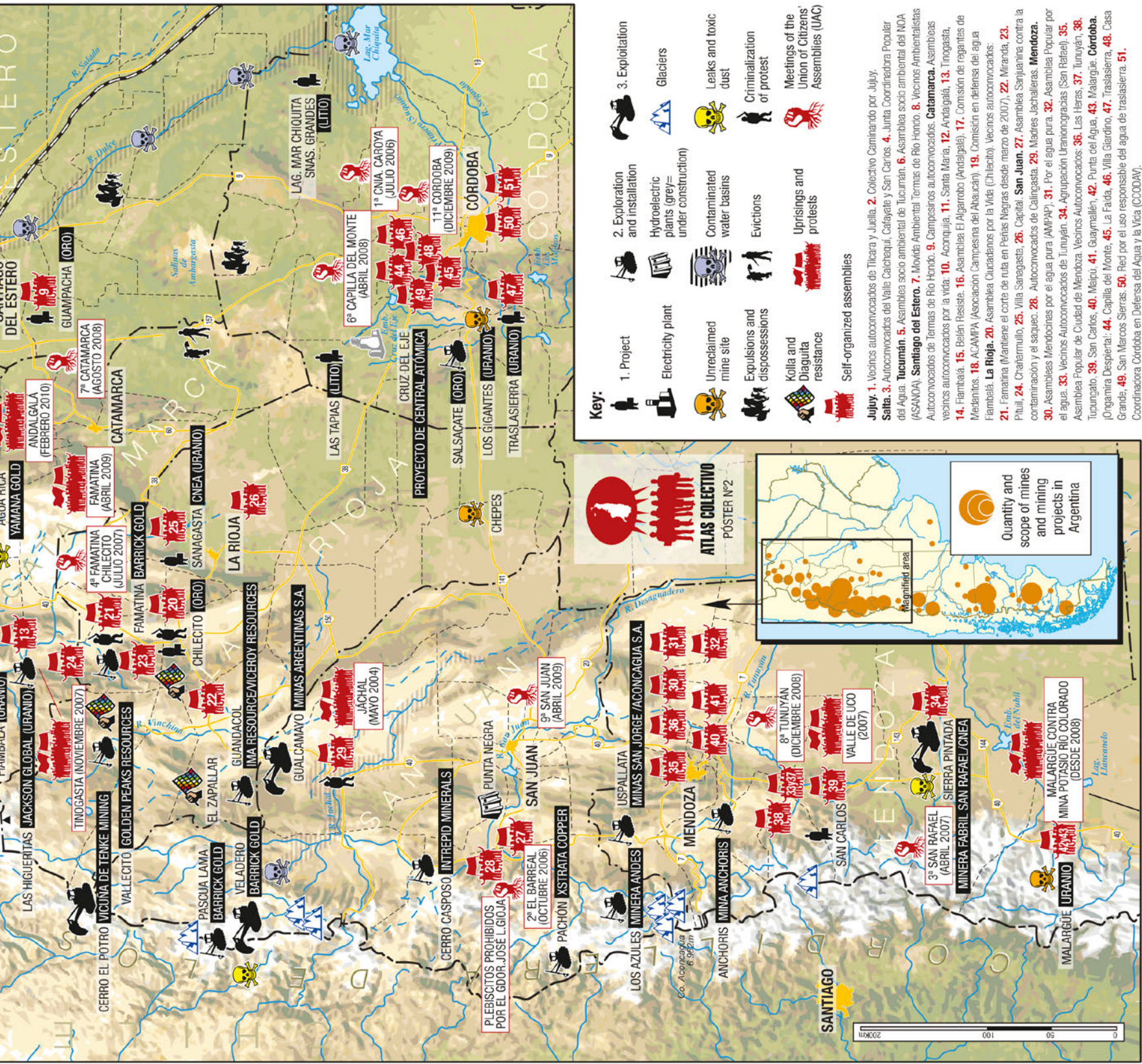

**Key:**

- 1. Project
- 2. Exploration and installation
- 3. Exploitation
- Electricity plant
- Hydroelectric plants (grey= under construction)
- Glaciers
- Unreclaimed mine site
- Contaminated water basins
- Leaks and toxic dust
- Expulsions and dispossessions
- Evictions
- Criminalization of protest
- Kolla and Diaguita resistance
- Uprisings and protests
- Meetings of the Union of Citizens' Assemblies (UAC)
- Self-organized assemblies

**July 1.** Vecinos autoconvocados de Tilcara y Juella. **2.** Colectivo Caminando por July. **3.** Autoconvocados del Valle Caichequi, Catayate y San Carlos. **4.** Junta Coordinadora Popular del Agua. **5.** Asamblea socio ambiental de Tucumán. **6.** Asamblea socio ambiental del NOA (ASANO). **7.** Movida Ambiental Termas de Río Hondo. **8.** Vecinos Ambientalistas Autoconvocados de Termas de Río Hondo. **9.** Campesinos autoconvocados. **10.** Aconquija. **11.** Santa María. **12.** Andalgala. **13.** Tinogasta. **14.** Flametal. **15.** Belén Basista. **16.** Asamblea El Algarrobo (Andalgala). **17.** Comisión de ragantes de Mendocinos. **18.** ACAMPA (Asociación Campesina del Abtaucán). **19.** Comisión en defensa del agua. **20.** Asamblea Ciudadanos por la Vida (Chilcito). Vecinos autoconvocados. **21.** Famatina (Mantiene el corte de ruta en Peñas Negras desde marzo de 2007). **22.** Miranda. **23.** Pihú. **24.** Chaharrullo. **25.** Villa Sanagasta. **26.** Capital. **27.** Asamblea Sanjuanina contra la contaminación y el saqueo. **28.** Autoconvocados de Calingasta. **29.** Madres Jachaleras. **30.** Asamblea Popular de Ciudad de Mendoza. Vecinos Autoconvocados. **31.** Por el agua pura (AMPAP). **32.** Asamblea Popular por el agua. **33.** Vecinos Autoconvocados de Tunuyán. **34.** Agrupación Uranonogracias (San Rafael). **35.** Tupungato. **36.** San Carlos. **37.** Las Heras. **38.** Tunuyán. **39.** Asamblea Popular de Ciudad de Mendoza. Vecinos Autoconvocados. **40.** Guaymallén. **41.** Guaymallén. **42.** Punta del Agua. **43.** Malargüe. **44.** Casa Ñangrma Despierta. **45.** La Falda. **46.** Villa Giardino. **47.** Traslasierra. **48.** Casa Grande. **49.** San Marcos Sierras. **50.** Red por el uso responsable del agua de traslasierra. **51.** Coordinadora Córdoba en Defensa del Agua y la Vida (CCODAV).

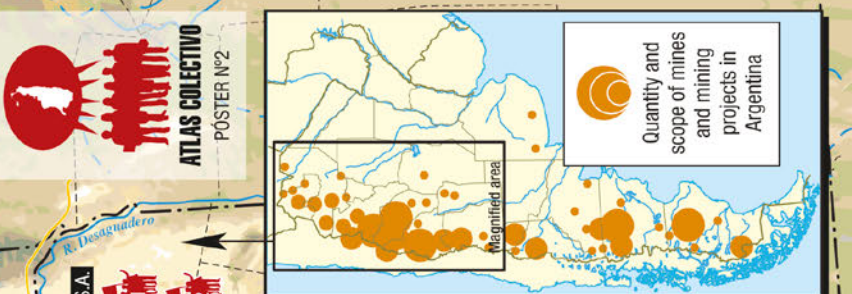

# Mapping Global Environmental Conflicts and Spaces of Resistance

Environmental Justice Atlas – Leah Temper  
ejatlas.org

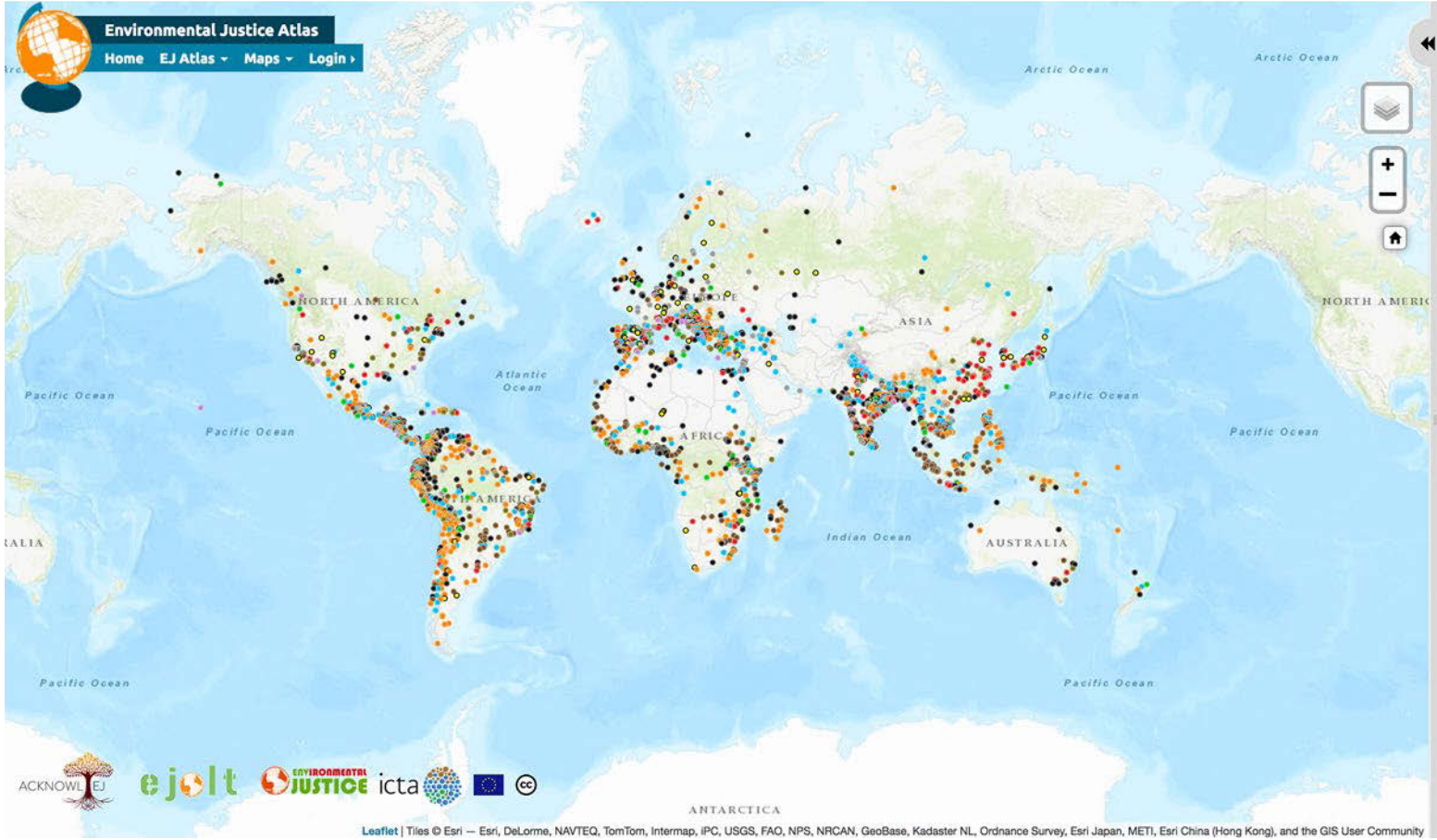

The environmental movement has been described as "the most comprehensive and influential movement of our time" (Castells, 1997: 67), representing for the "post-industrial" age what the workers' movement was for the industrial period. While strike statistics have been collected for many countries since the late nineteenth century and are currently tracked by the World Labour Organization, until the beginning of this research project there has been no attempt to track the occurrence and frequency of mobilizations related to environmental issues. The Global Atlas of Environmental Justice (EJ Atlas) was conceived to address this gap. The EJ Atlas traces the outline of an emerging global movement for Environmental Justice through its localized manifestations (Martinez-Alier et al., 2016). It currently documents over 2100 cases of ecological conflicts around the world (as of May 2017). Each point in the atlas represents one conflict, defined as local mobilization or protest against an environmentally destructive activity or policy. Each case or data-sheet, is documented by an organization or an activist scholar involved in the resistance. Each case outlines the history, actors, impacts, claims and outcomes of the conflict and also provides photos, references, and links (for a description of the project see Temper et al., 2015).

### **Aims of the EJ Atlas**

The atlas aims to make visible protests against environmental pollution and degradation through participatory counter-hegemonic cartography involving scholar-activists, civil society and academics. By telling the stories of those fighting on the ground to preserve the environment, we aim to show that these grassroots activists on the front lines are putting forward a vision for a truly sustainable economy. Unfortunately, for this work they are often also putting their lives on the line. As Global Witness (2016) reports, environmental activists were murdered at a rate of 3 per week last year. This makes bringing attention to these struggles all the more urgent.

The atlas is also a contribution to understanding the drivers and interconnections between conflicts on a global scale. Most research on such conflicts is undertaken at either the case study level or sometimes at a national or regional level and focuses on specific areas or activities. The EJ Atlas offers a tool for meta-analysis that can transcend individual cases in order to identify patterns, relationships among cases and actors and how such conflicts are shaped by the larger political economy.

In addition to the global scale, the methodology for data gathering is also a unique aspect of the EJ Atlas. Environmental Justice was a community-led science from the beginning. By drawing on the concept of activist knowledge, the harvest of data in the mapping process was carried out by the communities themselves, as a form of citizen science and popular epidemiology (Escobar, 2008). In fact, as many researchers in EJ studies engage with communities through processes of Participatory Action and Collaborative Research (Bacon et al., 2013), such forms of engagement attempt to more actively include communities in the process of knowledge production. The researchers hereby recognize the communities as producers of knowledge in their own right rather than merely

objects of study (Casas-Cortés et al., 2008). There is a need for developing "science with the people" rather than for the people, especially in those fields characterized by "irreducible uncertainties and ethical complexities" (Funtowicz & Ravetz, 1994: 198). As such, this research is not focused on studying a movement or a specific group of people, but to study together with them and based on an "ecology of knowledges", as Boaventura de Souza Santos (2007) suggests. While needs of collaboration are often acknowledged both by scholars and activists, so far there was not a space of interaction enabling collaborative research on EJ conflicts on a global scale. This is precisely what the EJ Atlas collaborative Research Initiative advocates.

The EJ Atlas mapping process has further sought to integrate the knowledge of several already existing platforms in order to draw on previous work from both activists and scholars. These initiatives include the Map of Environmental Injustice in Brazil, supported by the Fundacio Oswaldo Cruz (FIOCRUZ), the Centro di Documentazione sui Conflitti Ambientali (CDCA), the Latin American Observatory of Mining Conflicts (OCMAL), Genetic Resources Action International (GRAIN), World Rainforest Movement (WRM) and Oilwatch. These initiatives continue to support and document community struggles globally against extractivism, mining, tree plantations, deforestation and, fossil fuel extraction and towards food and energy sovereignty as well as climate and Environmental Justice.

### **The EJ Atlas: A Living Document and a Tool for Extending the Practice and Theory of Environmental Justice**

The unit of analysis is a well-documented project-based campaign or place-based struggle, which sometimes results in influential national protest events or broader campaigns. These contestations are made visible through press reports and court cases, campaigning, petitions, meetings, demonstrations, boycotts, strikes, threats, civil disobedience, collective violence and other action forms. For each conflict, two or three pages of detailed information are available, as reported by over 100 collaborators at present, from Environmental Justice Organizations (EJOs) or academics and graduate students working on the ground or from secondary sources about that issue. A laborious moderation process, facilitated by the Institute of Environmental Science and Technology (ICTA) and Universitat Autònoma de Barcelona (UAB), assures quality and consistency of each entry before being published online (for more details see Temper et al., 2015).

The form, conceived after several decades of research on extractive industries and related conflictivity and collaboration with activist groups, is framed around the type of activity, commodity extracted and actors involved (companies, international or finance institutions, etc.). It focuses on the project itself, on the features of the mobilization, resistance or campaign, on the impacts and on the outcomes. The initial form has been slightly adjusted and improved during the lifespan of the mapping project, following advice and feedback from activists through an iterative process. This highlights how the EJ Atlas is a living document and a tool

that can be adapted to new needs during its implementation and use. At the end of the project it can be said to be one of the most exhaustive databases with more than 100 fields, including both multi-choice and free text boxes.

The EJ Atlas has been used widely by teachers as a pedagogical tool for teaching environmental issues from high school to the post-graduate level, by activists for organizing and campaigning, by journalists and researchers and by policy-makers and governments, among many others. Furthermore, the EJ Atlas provides empirical material for a research agenda that contributes to understanding how inequalities are shaped through socio-metabolic transformations in the economy, how they are contested and to what outcomes. The EJ Atlas holds significant promise for extending both the practice and theory of Environmental Justice and geographical scholarship through certain aspects:

- By integrating further activist knowledge into analysis to contribute to the theoretical development of EJ and through new forms of knowledge co-production.
- Through a multi-scale framework that allows a wider geographical analysis of relationships and interconnections between actors, struggles as well as financial and energetic flows. Such a framework can help discern the coalitions of power that produce and benefit from prevailing patterns of production and consumption. It can also highlight the groups that suffer the most and in doing so provide a useful point of departure for constructing coalitions or policy-based interventions in order to protect the rights of vulnerable groups.
- A geographical perspective that through geo-location and cartographic data allows an interface between the natural and social sciences, by integrating features of the territory and social, institutional and cultural processes into social analysis.

### Outcomes: Collaborative Featured Maps

After collecting so much information about conflicts and resistances across scattered locations, there is a need to make sense to those dots and their interconnections and to understand them in their historical and geographical context. Featured maps aim to be visual tools to tell stories and explain such interconnections across space and time. Hosted on our online platform, they include a curated selection of conflicts around a specific thematic issue or regional focus, along with additional relevant data and vector layers on the map to visualize the situation better. In the following we want to give an insight into our featured map projects.

**The map of Environmental Injustices in Turkey** was the first featured map to be developed. It was still under construction when the mobilization at Gezi Park happened and was exhibited on a tree during the demonstrations in June 2013. It was later on further developed and published online in Turkish. It contributed to a critical discussion in the Turkish media and civil society about contested large infrastructure projects in the country.

**The Fracking Frenzy map** draws from the report *Fracking Frenzy* by Friends of the Earth and presents 30 conflicts and mobilization by "Fracktivist" movements around hydraulic fracturing activities across the world. Along with geo-spatial data on the reserves, extraction concessions and companies operating in the country, it shows any additional data on impacts on the groundwater.

**The Climate Debt map** shows all fossil fuels and Climate-Justice-related conflicts and highlights the spatial mal-distribution of climate change sources. It displays CO<sub>2</sub> emissions per capita and a climate change vulnerability index as well as the total carbon debt/claim of 154 countries in 2011 in million tons of CO<sub>2</sub> as calculated by Rikard Warlenius, Human Ecology, Lund University.

**The Mining Conflicts in Latin America map** is related to the mining boom Latin America has experienced in the last four decades. This map displays how the expansion of the metal mining frontier overlaps with environmental (biodiversity hotspots, forests) and socially sensitive areas (water resources, peasant and indigenous lands) and the related conflicts. Forty percent of these conflicts have seen violent repression or criminalization of activists. The map integrates data from the Global Witness report "Deadly Environment", highlighting how environmentalists are being targeted for their defense of the environment.

**The Chevron map** shows more than 30 cases of conflict worldwide due to Chevron activities, an emblematic example of corporate violation of human rights against people as well as of corporate impunity. Moreover, according to a study published in *Climatic Change*, Chevron is the company which contaminated the planet most with its carbon dioxide emissions during a period of 150 years (Ekwurzel et al., 2017). The aim of this map is therefore to show major conflicts concerning extractive activities led by the Chevron Corporation as well as people's resistance and struggles against it. This map is the result of a collaborative project between the EJ Atlas research team at ICTA - UAB, the Unión de Afectados por Texaco - UDAPT, and A SUD - Ecologia e Cooperazione ONLUS and CDCA - Centro di Documentazione sui Conflitti Ambientali, Italy, and was created as a campaign tool for the Global Anti-Chevron Day held each year on May 21st. It was used during the 2016 shareholders' assembly by one of the UDAPT lawyers to show the systemic nature of the environmental and human rights violations perpetrated by the company.

**An Italian sub-platform** ([atlanteitaliano.cdca.it](http://atlanteitaliano.cdca.it)) was developed with the active involvement of local committees involved in environmental conflicts in the country through the implementation of a participatory tool for citizens. The Italian Atlas was also presented on the 14 April 2015 at the European Parliament where meetings were held with Parliamentarians in order to discuss how to address the issues raised. In addition, meetings with local committees were held in order to network, discuss and improve the participatory process and the atlas as a political tool.





## Conclusion

Through the cooperation with EJOs and their networks in a "hybrid research collective" we hope to further develop and to contribute to the concept of a global EJ movement. As this movement is already growing, we hope that it will continue to cohere globally, to formulate more strategic positions and be more inclusive at the same time as it takes on local nuances. We hope to be able to describe these processes and to analyze new concepts coming from the grassroots movements and to roughly map the patterns in the participation of women, of indigenous peoples, of labour unions and religious groups, and their different ways of intervening in conflicts of Environmental Injustice. As conflicts intensify, especially along the commodity extraction frontiers and through the creation of new commodities, we aim to research, exchange and disseminate more information.

Our hope is that the EJ Atlas can serve as a tool which can benefit from case studies but also go beyond them, for fruitful comparisons across time and space. Beyond research in political ecology, the map aims to be socially and politically relevant by "naming and shaming" the actors behind injustices. It is furthermore supposed to serve as a tool for activists by illustrating critical environmental issues and encouraging public debate over the distribution of risks, burdens and benefits as well as the claims of local communities and their visions for what Environmental Justice looks like.

## References

- Bacon, C., de Vuono-Powell, S., Frampton, M.L., LoPresti, T. & Pannu, C. 2013. Introduction to Empowered Partnerships: Community-Based Participatory Action Research for Environmental Justice. *Environmental Justice*, 6(1): 1-8.
- Casas-Cortés, M.I., Osterweil, M. & Powell, D.E. 2008. Blurring Boundaries: Recognizing Knowledge-Practices in the Study of Social Movements. *Anthropological Quarterly*, 81(1): 17-58.
- Castells, M. 1997. *The Information Age*. Oxford: Blackwell Publishers.
- De Sousa Santos, B. de S. ed. 2007. *Cognitive Justice in a Global World: Prudent Knowledges for a Decent Life*. Lanham: Lexington Books.
- Ekwurzel, B., Boneham, J., Dalton, M.W., Heede, R., Mera, R.J., Allen, M.R. & Frumhoff, P.C. 2017. The Rise in Global Atmospheric CO<sub>2</sub>, Surface Temperature, and Sea Level from Emissions Traced to Major Carbon Producers. *Climatic Change*, 144(4): 579-590.

Escobar, A. 2008. *Territories of Difference: Place, Movements, Life, Redes*. Durham: Duke University Press.

Funtowicz, S.O. & Ravetz, J.R. 1994. The Worth of a Songbird: Ecological Economics as a Post-Normal Science. *Ecological Economics*, 10(3): 197-207.

Global Witness ed. 2016. *On Dangerous Ground*. [globalwitness.org/en/reports/dangerous-ground](http://globalwitness.org/en/reports/dangerous-ground), 13 January 2018.

Martinez-Alier, J., Temper, L., Del Bene, D. & Scheidel, A. 2016. Is There a Global Environmental Justice Movement? *The Journal of Peasant Studies*, 43(3): 731-755.

Temper, L., Bene, D. del & Martinez-Alier, J. 2015. Mapping the Frontiers and Front Lines of Global Environmental Justice: the EJAtlas. *Journal of Political Ecology*, 22(1): 255-278.

## Illustrations

Map on previous spread left by EJOLT, ACKnowl-EJ and ENVjustice Projects – Collaborative Research Projects led at ICTA, Universitat Autònoma de Barcelona.

Photograph above left by Leah Temper: An oil spill in Bodo, the Niger Delta. Shell's operations in the Delta have seen over fifty years of pollution, community protests and state violence. The Niger Delta is one of the most biodiverse and polluted places on the planet.

Photograph above right by Daniela Del Bene: Thousands of people from across India gathered at Delhi on 2 December 2014 as part of a convergence to protest the unjust and undemocratic decisions of the Modi government on issues of land acquisition, forest rights, health, agriculture, education and land.

Map on following spread: Poster of the Turkish map of Environmental Justice, printed to be displayed in Gezi Park.

# MAP OF ENVIRONMENTAL INJUSTICES IN TURKEY

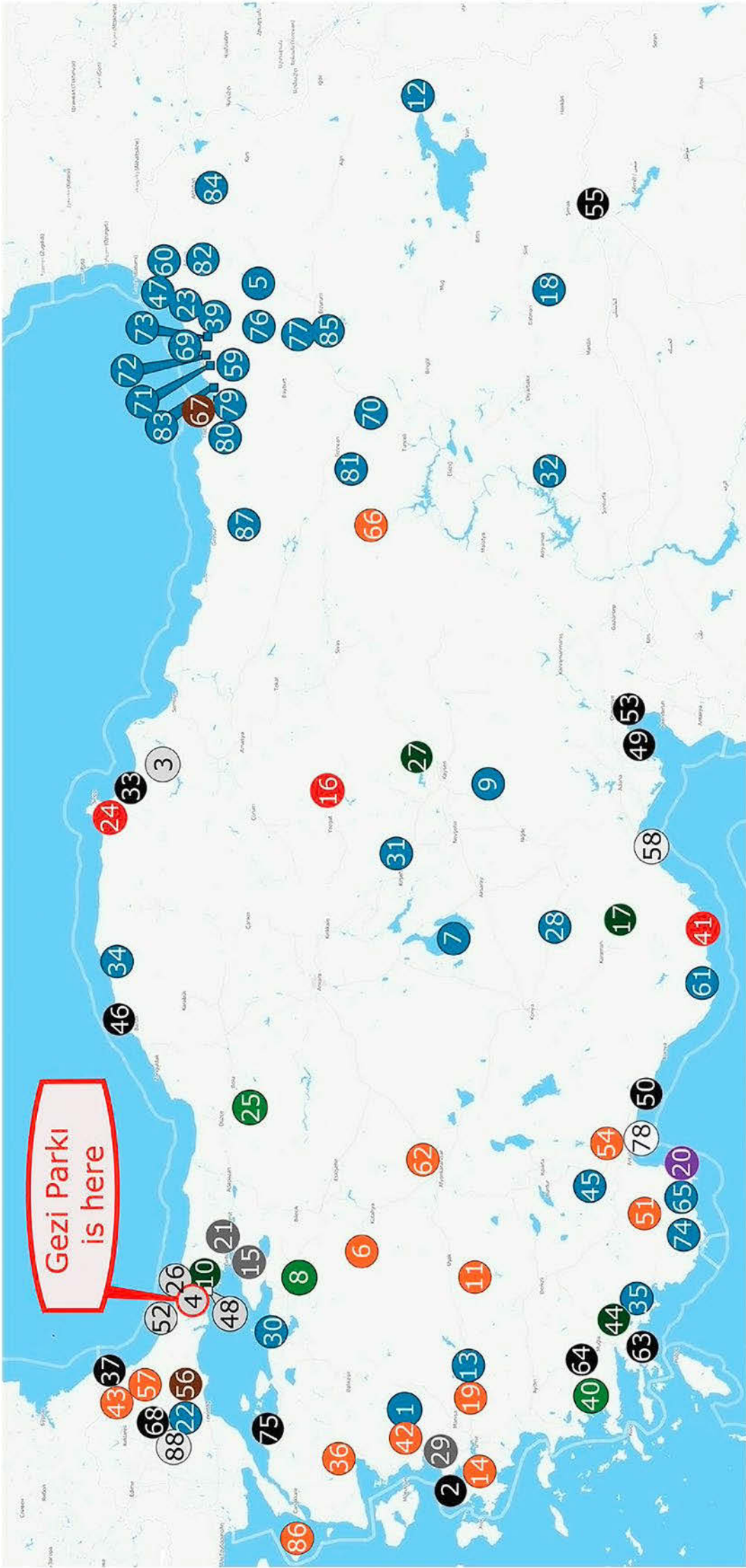

This map is a collective effort in progress which aims to bring together the environmental conflicts in Turkey by benefiting from the knowledge and experiences of the local movements and activists.



Environmental Justice Organisations, Liberties and Trade  
Mapping Environmental Justice  
www.ejolt.org  
Politik Ekoloji Çalışma Grubu  
For more information (in Turkish)  
www.cevrehtilafilari.org

- Mineral Ores and Building Materials Extraction
- Water
- Industrial and Utilities Conflicts
- Fossil Fuels and Climate Justice/Energy
- Biodiversity conservation

- Nuclear
- Tourism Recreation
- Infrastructure and Built Environment
- Biomass and Land (Forests, Agriculture, and Livestock)
- Waste Management

#	Name of the Conflict
1	Allianoi Ancient City and Yortanlı Dam
2	Unlawful removal of olive trees and wind energy project in Karaburun
3	Black Sea Coastal Highway Project
4	Taksim Square construction works
5	Tortum Bağbaşı Hydroelectric Power Plant Project
6	Eti Silver Mine Cyanide Dam
7	Drying up of Tuz Lake Closed Water Basin
8	Uluabat Lake
9	Sultan Marshes Wetland
10	Kuzguncuk Vegetable Gardens
11	Kışladağ Gold Mine
12	Sharing the water of Mahi Stream at Muradiye Reservoir
13	Marmara Lake
14	Özbek Village Stone Quarry Construction
15	Yalova VOPAK Chemical Storage Terminal
16	Yozgat Uranium Mine
17	Struggle for the Preservation of the Way of Life of Sarıkeçili Nomads
18	Ilisu Dam and Hydroelectric Power Plant
19	Çaldağ Nickel Mine
20	Leasing of the Çıralı Coast
21	Cancer-related deaths due to air pollution in Dilovası Industrial Zone
22	The Pollution of Ergene River and Basin
23	Findıklı Paşalar Regulator and Hydroelectric Power Plant Project
24	Sinop Nuclear Power Plant
25	Abant Lake Nature Park
26	Movement Against the Third Bridge in Istanbul
27	Genetically Modified Organisms
28	Hotamış Marshes
29	Aliağa Industrial Conflicts

#	Name of the Conflict
30	Kocaçay Delta
31	Seyfe Lake Drought Problem
32	Southeastern Anatolia Project (GAP)
33	Gerze Coal Burned Thermal Power Plant
34	Loç Valley, Cide Hydroelectric Power Plant.
35	Yuvarlakçay Water Movement
36	İda Mountain Prospecting for Gold
37	Beğendik Thermic Power Plant
38	Aliağa Thermic Power Plants
39	Artvin Kabaca Valley Hydroelectric Power Plant
40	Bafa Lake Nature Park
41	Akkuyu Nuclear Power Plant
42	Bergama Gold Mine
43	Istranca/Yıldız Mountains Mines and Quarries
44	Destruction of the Sigla Forests
45	Drying out of Burdur Lake
46	Amasra Thermic Power Plant
47	Şelale Stream Hydroelectric Power Plant
48	Construction Works in Haydarpaşa Train Station
49	Sugözü Thermic Power Plant
50	Transformation of the Sorgun Forest into a Golf Course
51	Elmalı Quarry
52	Third Airport in Istanbul
53	Erzin Thermic Power Plant
54	Kurşunlu Quarry
55	Silopi Thermic Power Plant
56	Çorlu Solid Waste Burning Facility
57	Çakıllı Cement Plant
58	Urban Transformation in the Neighborhoods of Mersin

#	Name of the Conflict
59	Ikizdere Hydroelectric Power Plant
60	Düzenli Hydroelectric Power Plant
61	Otluca Hydroelectric Power Plant
62	Afyonkarahisar Beyyazı Quarry
63	Gökova Thermic Power Plant
64	Yatağan Thermic Power Plant
65	Alakır Valley Hydroelectric Power Plant
66	Erzincan Gold Mine
67	Trabzon Solid Waste Facility
68	Hamidabat Thermic Power Plant
69	Şenoz Valley Hydroelectric Power Plant
70	Pülümür Dam and Hydroelectric Power Plant
71	Salarha Valley Hydroelectric Power Plant
72	Güneysu Valley Hydroelectric Power Plant
73	Hemşin Hydroelectric Power Plant
74	Kasaba Regulator and Hydroelectric Power Plant
75	Karabiga Thermic Power Plant and Ash Storage Facility
76	Aksu Valley Hydroelectric Power Plant
77	Gelinkaya Hydroelectric Power Plant
78	Küçük Aksu Dam and Hydroelectric Power Plant, Irrigation Project, Borrow Pit, Concrete Plant
79	Kayacık Hydroelectric Power Plant
80	Foç Stream Hydroelectric Power Plants
81	Gökçeköy Hydroelectric Power Plant
82	Coruh Energy Plan and Hydroelectric Power Plants
83	Solaklı Valley Hydroelectric Power Plants
84	Kura River Hydroelectric Power Plant
85	Karasu Hydroelectric Power Plant
86	Struggle against the gold mine in Gökçeada
87	Inundation of the Gelivera Village under the water of the hydroelectric power plant
88	Logistic Storages constructed in forest land in Thrace

# Collaborative Cartography in Defense of the Commons

GeoComunes  
geocomunes.org



GeoComunes is a collective that carries out research and collaborative mapping for the defense of common goods. We understand common goods as all elements that are integrated within the process of social reproduction and which by that form the very fabric of freedom and any possible life in the community.

Our cartographic perspective includes two axes of development. The first one is based on the idea that the Commons' defense requires the investigation and mapping of the territoriality and capital which seek to appropriate the common goods. We are interested in visualizing the connections between the expansion of mega-infrastructure projects and the transformation of Commons into commodified goods. We are also interested in making visible the territorial logic of capital in Mexico: the connections between the expansion of transport infrastructure projects (such as highways, ports and airports) and those of energy infrastructure (gas pipelines, oil pipelines, hydroelectric dams and others), the mega-mining and industry, all over the territory. The second axis is based on the conviction that collectively mapping the common goods (forests, water wells, rivers and so on) strengthens their defense and communal management. In other words: It is necessary to investigate, systematize and share information about the territory that we defend.

We believe in the strength of collaborative work. This is why our methodology includes research, tours, workshops and mapping exercises with urban and rural communities that face some kind of socio-environmental conflict. In defense of their territory they consider collective mapping as a tool in the battle they wage. After being invited, we design, together with the organized community, a cooperation route for the realization of cartographic tools, constructing a collective analysis around the affected regions.

The methodology of GeoComunes is carried out in several stages. The first one is to systematize the information available from official sources, the local press as well as the materials collected by the communities in conflict. This is followed by translating the technical information into cartographic knowledge which makes it possible to easily visualize the spatial dimensions of mega-infrastructure projects. The maps selected in the first stage are proposals that serve as a basis for initiating the cartographic dialogue with the communities affected by such projects.

The second stage is developed during workshops and tours, involving the collective construction of maps and intending to localize the Commons graphically. This exercise serves as a medium for the discussion, evaluation and projection of the common territory and the strategies for its defense. During its elaboration we share the knowledge of the territory that the members of the community have.

The third stage of GeoComunes' methodology consists of systematizing the knowledge which was built during the workshops and tours for the digital elaboration of maps, charts, graphs and infographics after they are complemented and enriched by complementary research. The results are digitized for the cartographers, who then meet in the collective mapping workshops we described in the second stage. Once the information is validated by both parties, GeoComunes and the organized community, the maps are printed and distributed to interested individuals, who then become part of the wider collaborative mapping community.

The fourth stage of our methodology involves the use and conversion of collective maps into territorial defense tools. The first users of the collective maps are always members of collective mapping communities. Only after these maps are delivered to communities, the GeoComunes team freely and openly shares the layers and maps and analyzes them on the virtual platform [geocomunes.org](http://geocomunes.org). This website is central to our work because it contributes to the open access of strategic spatial information and its collaborative construction. Constructed with open source and free access, this GeoPortal, as we call our website, allows anybody to view and download all the elements of our cartography (maps, layers, analyses) and almost all the work that we created for editing and reproduction. These cartographic productions have been used to illustrate news stories, elaborated in direct collaborations with free and independent media. In some cases, collaborative cartography has even contributed to legal cases.

The collaborative mapping work began during socio-environmental conflicts in the metropolitan Zone of Mexico City in 2014, and on the other hand during a national synthesis of various infrastructure projects that helped to contextualize these conflicts. In two years different stages of collective mapping have been exercised in the Bajío region, in the center of Veracruz, south Chiapas, in the Northeast of the country, and throughout Central America. In addition, the participation has taken place in the form of various forums and meetings.

As an example of the work of these years, we now share a series of maps about a dam and water transfer project in the central west of Mexico: the Zapotillo Dam, which has been built to flood the town of Temacapulín and its surrounding environment. We consider that this case illustrates one of the various ways in which the territories in the country are being modified, unleashing a dispute for common goods between capital and people.

# Who is more thirsty?

The aqueduct between industrial, agroexport, mining and urban interests



### El Zapotillo and other hydraulics projects

- Dams under construction or in project
- Dams in operation
- Aqueduct in operation
- El Zapotillo Aqueduct
- León water macrocircuit project

### Activities with high water consumption

- Automotive assemblers
- Industrial parks
- Industrial brokers
- Mining concessions
- Agro-industrial farms
- Irrigation agriculture areas

### Rivers pollution level

- Low
- Medium
- Strong
- Extrem

### Infrastructure road and settlements

- Highway in operation
- Highway in project
- Secondary
- Urban zone

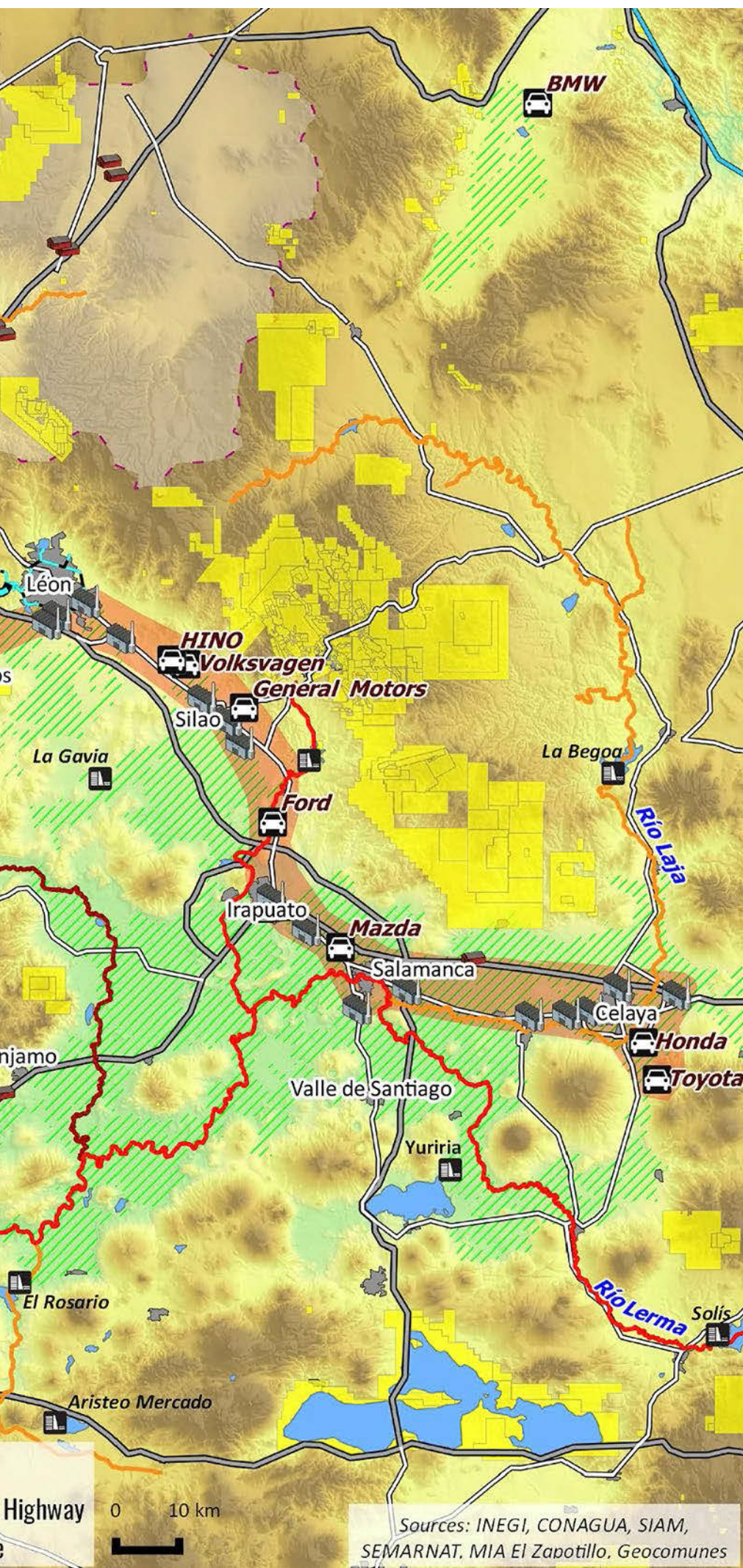

There has been the constant intention to modify large-scale metabolisms and water flows in the Lerma-Santiago River basin in Mexico. In the last 70 years a series of dams have been projected onto its tributaries in order to use its water in the city of Guadalajara and now in León. In the region of Los Altos de Jalisco, located between these two cities, water has become a geostrategic resource that is being hoarded by the big companies of Bajío. Dams are the means through which such control is achieved. One of them is the El Zapotillo Dam, which, together with a large aqueduct, is the project which is intended to bring water to the industrial area around the city of León. In effect this will cause the flooding of the communities of Temacapulín, Acasico and Palmarejo.

With this series of maps we want to show that the intention to modify water flows in this region of the country, with all the consequences it entails, responds to the business interests of the export industry in the state of Guanajuato. These materials were constructed while meeting with Temacapulín's organized companions and with the support of other social organizations that accompany the process. The final products were made with the objective of being used in the assemblies of the towns of the region and in information campaigns. This adds to a series of tools that are continuously being generated for the defense and community construction of the territory. The resulting maps show that this region, in addition to being threatened by water deprivation, is suffering from severe pollution generated by industry. Furthermore they show that this project will only increase environmental damage. The Santiago River is an extreme case and paradigmatic of the implications for health and environmental crimes that occur in Mexico.

What can you do about it? How can we stop the progress of dispossession, violence and abuse? In GeoComunes we think that the communal construction of information and the spatial analyses of the entrepreneurs of this affront and their project of private appropriation of common goods is fundamental to building an effective defense. As a collective, our commitment is for life and for its free and communal reproduction. In this struggle maps are one of our tools of organization.

**Illustrations**

Photograph on previous spread: Mural painting "Freedom – Temaca won't be sold".

The map on the left was originally published in Spanish and has been translated for its publication here.

# Knitted Flood Wall

## Initiating Political Entanglement through a Socially Engaged Participatory Art Project

Martina O'Brien

[martinaobrien.com](http://martinaobrien.com)





The Knitted Flood Wall, 2012, was a socially engaged participatory art project initiated by Irish Visual Artist Martina O'Brien in collaboration with The Ballsbridge Dodder Residents Association, Dublin. It was founded in the aftermath of the flooding of the River Dodder, Dublin, Ireland, 24 October 2011. The project witnessed the creation of a 45 feet long x 8 feet wide (13.7 x 2.4m) knitted replica floodwall which visually mapped the river's velocity flow and took participants six months to complete. This collaboration explored how art within the public realm can give a society a voice, how it can be utilized as an accessible language in which to mediate awareness of an issue, how it can act to gain political engagement and how it can create disaster risk reduction by pre-emption and anticipatory action.

## A History of Floods

The Dodder is one of the three main rivers in Dublin, Ireland, and has a history of flooding. The river originates on the northern slopes of the Kippure in the Dublin Mountains, and its course flows through the city before meeting The Irish Sea. Because of its steep gradient, the Dodder quickly responds to rainstorms and is known as a flashy river. In the past it has broken its banks on many occasions, causing serious damage and occasionally loss of life. The earliest references of these occurrences trace back to 1620 when it was recorded that "Some houses were swept down and many cellars and warehouses laid under water". "It [the flood] made a great havoc, carrying away banks, trees, ditches, hedges and the mill." Again, in 1754 another flood was recorded that "exceeds anything that can be remembered. Many cattle and people died and boats drove into the sea. Dublin resembled a place which had experienced all of the calamities of war. The River Dodder appeared like a sea." (Blacker, 1860)

One of the most recent severe floods prior to 2011 occurred on 25 August 1986 when Ireland was hit by the costliest tropical cyclone of the 1986 Atlantic hurricane season – Hurricane Charley. This historic event destroyed thousands of properties in the city and caused initial concern for the on-going safety of residents. Unfortunately, as often seen in similar instances, these efforts faded as quickly as the water retracted.

O'Brien moved into an area along the River Dodder in 2004 and became familiar with local narratives surrounding past floods. She also became aware that the elderly population in the area had lived with a sense of fear and anxiety for 60, 70 and in some cases 80 years, which resulted in them developing an exceptionally bitter-sweet relationship with the Dodder. Upon living through the 2011 flood herself and witnessing not only her home, contents and belongings destroyed by the deluge but also her neighbours' homes, she felt that something could be done to bring light to the vulnerability of her community's situation.

## Collecting the Threads

In early 2012 O'Brien began working on developing the idea of knitting a collaborative floodwall. The concept of utilizing knitting as a medium to create this artwork came about from conversa-

tions with residents; the act of situating wool – with its soft nature – outside in a concrete space seemed a fitting gesture. In addition to this, the aspect of comfort associated with yarn seemed to add to its suitability.

From the outset, she had a number of aims and objectives for the art project; firstly, it had to articulate the need for an immediate installation of a flood defence wall. Secondly, it was to be a genuinely collaborative and participatory project involving residents who had been directly affected by the flood. Thirdly, it was to enable a dialogue and a stronger bond within the community. She was also interested in the importance of a participatory project from a psychological perspective and felt that working together might help to strengthen the communities' interactions. Finally, it was to involve the making of a replica velocity map, taken from the Catchment Flood Risk Assessment and Management (CFRAMS) study of the River Dodder (see map on the following spread). By doing so, it allowed the artwork to become a vehicle with which to open up a conversation with local authorities and governmental bodies.

The Catchment Flood Risk Assessment and Management (CFRAMS) is the medium to long-term strategy for the reduction and management of flood risk in Ireland and delivers on core components of the National Flood Policy, adopted in 2004, and on the requirements of the EU "Floods" Directive. The Office of Public Works, Dublin, is the lead agency for flood risk management in Ireland and is the national competent authority for the EU Floods Directive. Dublin City Council worked with the Office of Public Works to produce provisional studies of the River Dodder; these included a variety of models and maps. The velocity map was one of these maps and was chosen because it visually conveyed the speed of the river and highlighted the most vulnerable areas along the periphery (see following spread at the bottom right).

O'Brien and the affected community were aware that there were plans to eventually install a flood defence wall in the area through the CFRAMS programme. However, this had to run the course of planning permission being applied for and granted, ring fencing of budgets and economic pressures, all of which could have delayed the installation of a defence floodwall by years. These possible delays were a real concern to the community since, as we all know, the concept of a "one in one hundred year flood" is now becoming a very regular occurrence globally.

## Knitting a Community

Early 2012, a new residence association was set up in the area by local householders to help residents deal with local authorities, insurance companies, politicians, and government bodies. This was called the Ballsbridge Residence Association. In April 2012, O'Brien proposed the concept of The Knitted Flood Wall to the association's committee members and received a mixed response; some amused laughs, some interested supporters and some resistance by a few concerned members who felt it might be seen as a vehicle of protest; they worried that, as a group, they may be seen as trouble makers. Regardless of the feedback received, O'Brien proceeded with the concept and presented the idea at a communi-

ty meeting where she asked people to sign up. Some twenty female participants, ranging in year from twenty to seventy, committed to the project and work got under way.

Weekly meetings were held over a six-month period so that the group could knit together, develop the overall pattern and insure that the artwork followed the pattern base of the velocity map as closely as possible. Another important aspect of the meetings was that they created a space for participants to get to know each other better, talk and bond. As people shared their experiences, these collective gatherings created an intimate space to weave together a strong bond and gave participants a sense of proactive empowerment.

Once the larger community began to see the Knitted Flood Wall artwork take shape and grow both in length and momentum, the project was given support by everyone in the area.

### Constructing the Floodwall(s)

On target, the artwork was finished early October in time to mark the first anniversary of the 2011 floods and to coincide with the CFRAMS planning permission timeline. The Knitted Flood Wall was installed along the river on 20 October 2012 for a period of seven days (see photograph on the top right). The process of installing the artwork along the river itself caused its own set of difficulties and required meetings and planning permission being applied for and granted from the Dublin City Council. Both the Ballsbridge Dodder Residents Committee and the artist invited the Office of Public Work's leading engineer, politicians from both Fine Gael and the Green Party, along with the Lord Mayor of Dublin to officially open the artwork once it was installed. By virtue of this process, it made all parties fully aware of the community's situation and the need for the immediate installation of a flood defence wall. In addition to this, the highly visible nature of the artwork drew attention from wider society and received a great deal of coverage through all media formats both locally, nationally and internationally. On 24 October 2012, the day of the anniversary, the Ballsbridge Dodder Residents Committee asked passers-by to sign a petition in support of the cause and as a result received thousands of signatures.

In 2013 the Office of Public Works and the Dublin City Council begun CFRAMS work on a new flood defence wall in the area around Ballsbridge, Dublin, and in 2015 the works were completed. These works received no objections during the planning stage, and it was felt that the Knitted Flood Wall project aided the timely installation of the new flood defence wall on many fronts.

Following on from the Knitted Flood Wall project, O'Brien continued to explore the relationship between communities and the River Dodder in her 2015 project *Casting Territory: A Contemporary River Keepers' Index of Lesser Known Patterns*. It was a collaborative art project with the Dodder Anglers Club, Dublin, which utilized the art of fly-tying to explore the angler's unique knowledge of flora and fauna, physical geography and role as guardians of the River Dodder, Dublin, Ireland.



#### References

Blacker, Rev. B.H. 2010. *Brief Sketches of the Parishes of Booterstown and Donnybrook, in the County of Dublin*. Dublin: George Herbert.

#### Illustrations

Photograph on the top of opposite page and on following spread by Michael Holly.

Illustration on the bottom of opposite page: RPS Consulting Engineers, Dodder Catchment Flood Risk Assessment and Management Study, 2010, all rights reserved © Ordnance Survey Ireland. Licence Number 2010/22/CCMA/Dublin City Council

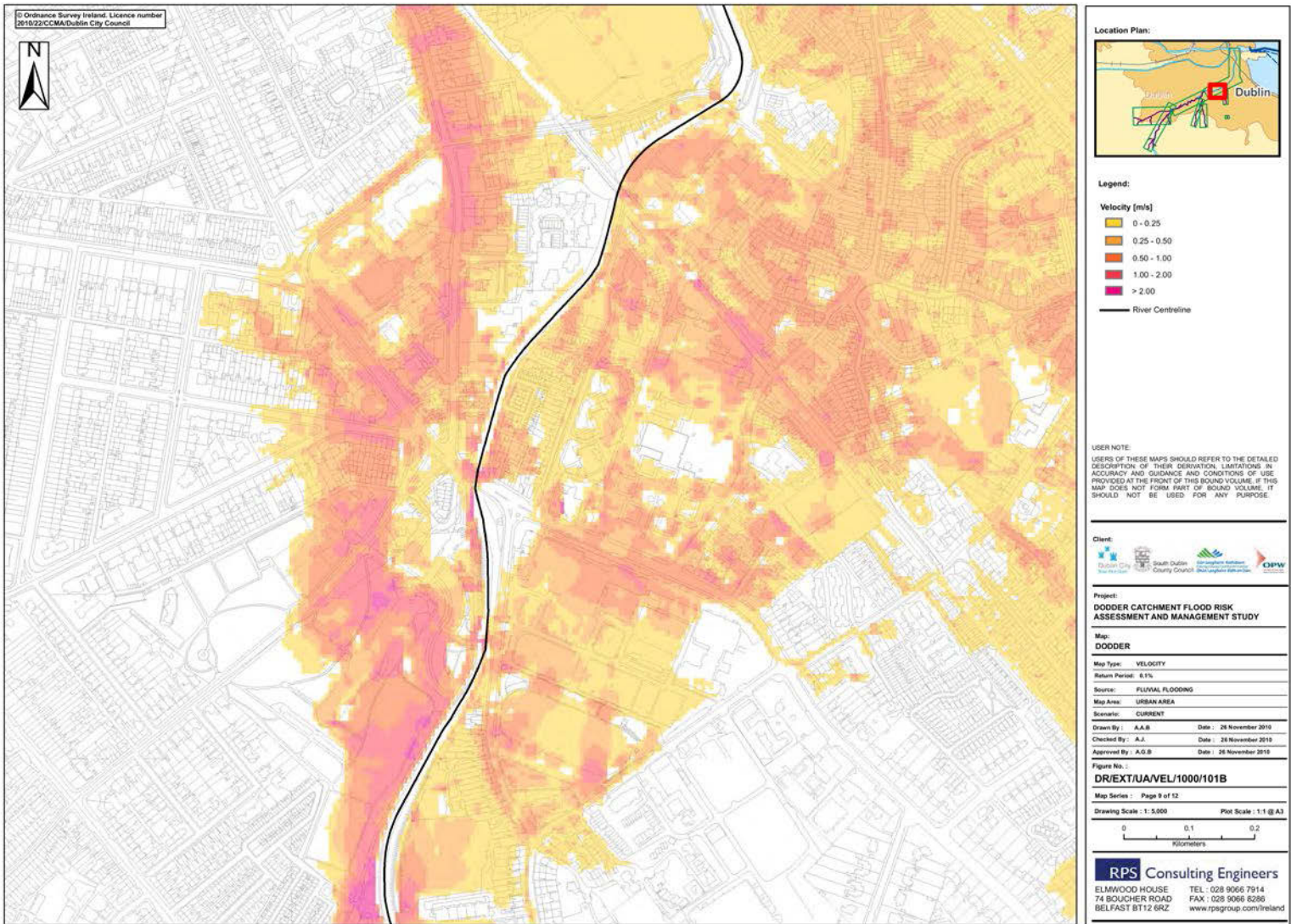





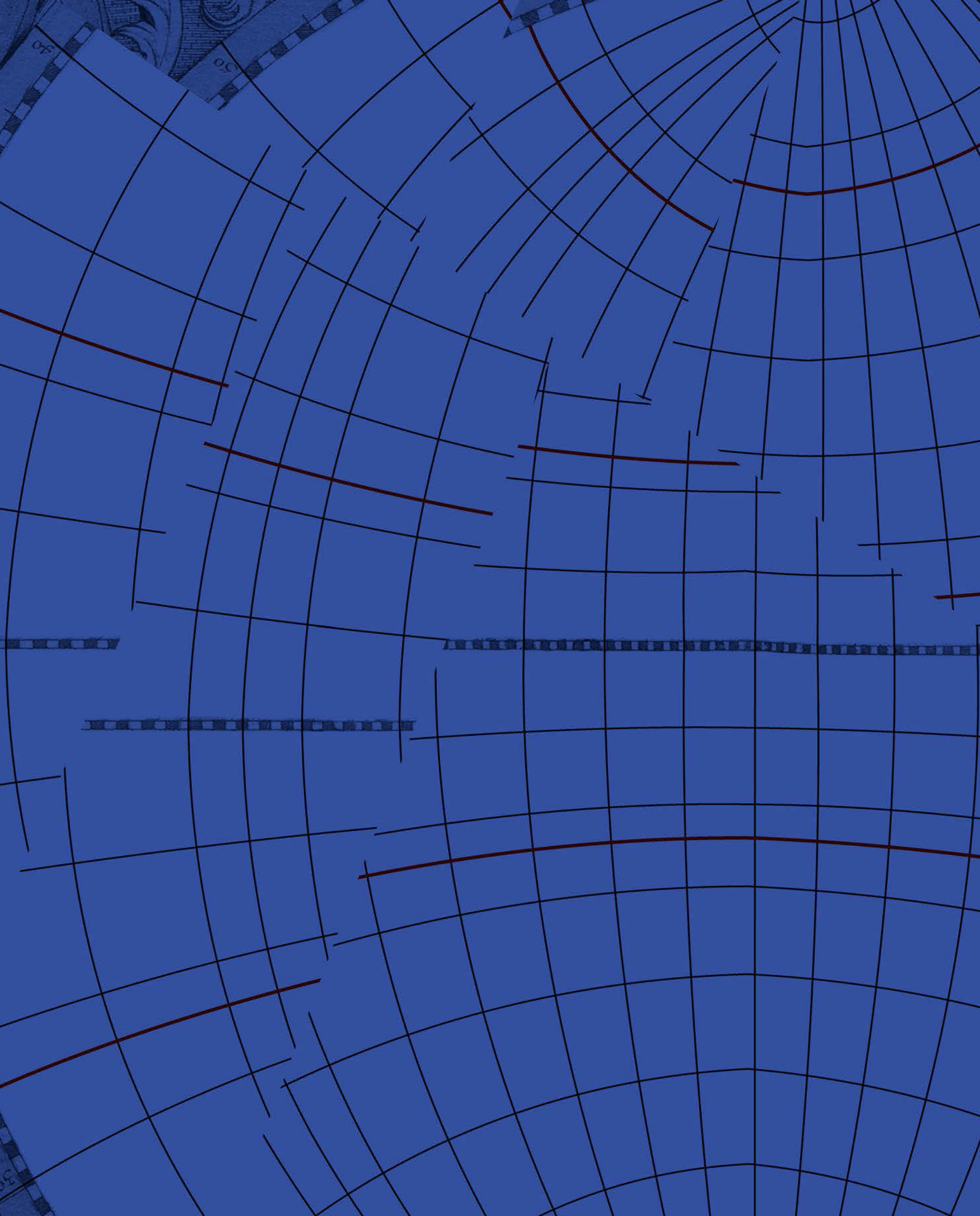



# Counter-Cartographies Build Political Pressure

# Indigenous Cartography in Acre

## Influencing Public Policy in Brazil

Comissão Pró-Índio do Acre – Renato Antonio Gavazzi

[cpiacre.org.br](http://cpiacre.org.br)





*"The map is the mirror of our community, it serves to show what we learn and helps in understanding the territory."  
IAAFs Raimundo Kaxinawá, 2008<sup>1</sup>*

The experience reported here refers to the Pro-Indian Commission of Acre (CPI / AC)<sup>2</sup>, which has been working to produce "Indigenous Cartography" with Indigenous Agroforestry Agents (IAAFs) as a means for managing their territories. In mapping natural resources, morphology, environmental conflicts, cultural historical elements and many other aspects of the landscape and life, with the effective participation of indigenous peoples, it is becoming an important tool for territorial and environmental management of indigenous lands in Acre.

The production of mental and geo-referenced maps, created through education, incorporates deep knowledge that indigenous peoples have about their lands and their environment. The indigenous mapping as a process has contributed to indigenous people using these maps, which were produced by them, as a tool for the planning and the management of their lands. This is especially noteworthy since maps have been tools that were historically used against them. This paper attempts to provide answers to the problem of territorial and environmental management of the Acre Indigenous Lands and the scene of conflicts experienced by some indigenous peoples with illegal logging in the border region between Brazil and Peru.

The ethnomapping workshops, educational activities carried out in indigenous communities, gather a significant number of indigenous representatives to discuss conflicts, problems and advances related to spatial and environmental management. These workshops are useful to map and classify the indigenous design, the different ecosystems that make up their land, areas of agricultural use, management and conservation of natural resources and agroforestry. They also deal with identifying and naming the main rivers, streams and lakes, areas of refuge for wildlife, cultural and spiritual sites, in their original indigenous language as well as identifying the history of occupation, the conflict areas and other significant aspects of indigenous peoples.

The ethnomaps<sup>3</sup> produced by Indians have become an extremely important tool in the planning of territorial and environmental management activities because the mapping practices enable reflections, discussions and community mobilization for more sustainable and organized forms of using the land and natural resources as well as protecting the biodiversity of the territory. Another important aspect of participatory mapping activities is the systematization and implementation of Land Management and Environmental Plans (LMEP).

## **The Indigenous Cartography – Some Achievements and Advancements in Acre**

The Indigenous Cartography in Acre has made significant progress since mapping the activities contributes and assists indigenous peoples in the production of many valuable materials for indigenous schools. This, in turn, supports the development of community projects and informs the surrounding society about the reality of the territory and the views of the people living in it. It further reflects and organizes the management and the protection of their territories. Some of the results of this work are that today many indigenous schools have maps and textbooks and materials of their lands in their languages. The maps were made by the Indians themselves, so consequently this has contributed to an improvement of teaching and targeting policy for minority languages in Brazil. The maps of indigenous lands contribute to the history of content, where indigenous peoples are historical subjects and active in the transformation of reality while valuing their narratives about the past and present. The geography contents assist in the discussions and reflections regarding their wealth and difficulties. It also assists in the students' and teachers' reflections on management processes of their territories.

*"Something I found really beautiful, was the fact that we wrote down the indigenous names for the rivers. We had already identified some of them, but now we found out that actually all of them originally had native names. But these names haven't been used by the younger generations. When the white men arrived, they gave their own names to the rivers. These names became the commonly used ones and only few people still remembered the native names. But now everybody knows the original names again and we want them to be used in the schools as well."*

*Bebito Pianko, 2004*

Another significant result of ethnomapping the Kampa Indigenous Land of Ammonia River in 2004 is that the maps produced by the Indians were important evidence to show the Brazilian government invasions of their land by Peruvian lumberjacks. This triggered a series of public actions of surveillance and enforcement along the borders Brazil-Acre and Peru-Ucayali. Another example of the power of maps and their significance as a political tool were discussions, negotiations, management and resolutions of conflicts between the Brazilian government and Kaxinawá Rio Humaitá. These maps were produced in the ethnomapping workshops of Indigenous Kaxinawá Rio Humaitá. They are important pieces of assistance in discussions and with the issues of negotiating with indigenous groups who voluntarily live isolated in the southern part of the indigenous land. The maps were used in awareness workshops as a tool that helped to develop protective strategies for isolated Indians and to solve inter-ethnic conflicts in that region.



The ethnomapping workshops initiated in 2004 contributed positively to the situation of the indigenous peoples of Acre, reflecting the construction and systematization of management plans for their land. From 2009 on, a very significant fact in relation to the uncovering of ethnomapping processes was the inclusion of "Territorial and Environmental Management Plans" in the public policy of the Acre state for indigenous peoples. Currently the state of Acre has 29 Plans of Territorial and Environmental Management of Indigenous Lands, and within its policy for indigenous peoples the state government has made human and economic resources available to the Indians. Through their associations, they can now implement part of their management plans into their communities. The policy focused on the territorial management of indigenous lands in the state of Acre. It positively influenced this policy on the national level for the Territorial and Environmental Management Plans for Indigenous Lands (PGTAs) and for participatory mapping (ethno-zoning and ethnomapping). It was set up in 2012 as key tools for the National Policy of Territorial and Environmental Management of Indigenous Lands in Brazil. Currently the Ministry of the Environment, along with the National Indian Foundation – FUNAI<sup>4</sup> – are responsible for promoting, supporting, developing and implementing the Plans of Territorial and Environmental Management of Indigenous Lands.

## Conclusion

The ethnomaps made by indigenous communities are important planning tools for the protection, conservation and management of natural resources. They fill the void of information found on official maps. They also expose opinions, ideas and aesthetic preferences. Furthermore, they are a powerful tool that can be used for various political purposes. The maps are also powerful tools to fight for certain claims. The production of ethnomaps creates the possibility for indigenous peoples to build their knowledge and values on the Indian's relationship with "the other", thus contributing to the formulation of a future strategy by enabling non-indigenous people to understand the processes of occupation of geographical space. It also sheds light on social interdependencies within the economic, political and ecological contemporary world. In this case, the cartographic knowledge of and for indigenous peoples can be an important advocacy tool within the territory and the cultural and intellectual heritage it depicts.

# Mapa de uso da terra da Aldeia São Joaquim - TI Kaxinawá do Baixo Rio Jordão

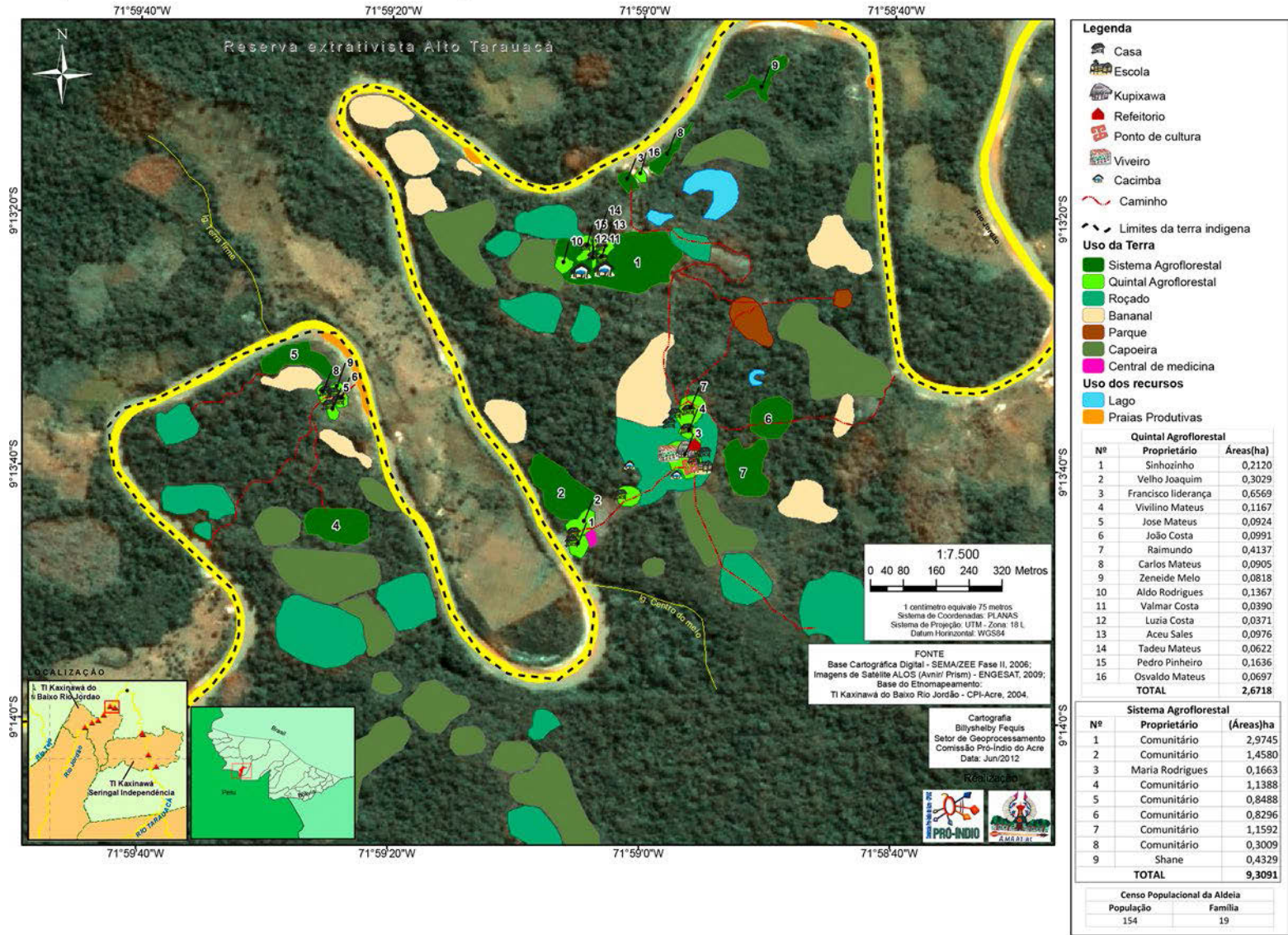

## Endnotes

1. All citations extracted from interviews with the participants of ethno-mapping-workshops conducted by Renato Gavazzi.
2. The Pro-Indian Commission of Acre and a non-profit organization of Brazilian civil society, based in Rio Branco, state capital of Acre, were founded in 1979 during the period of struggle for Brazilian democracy and in times when indigenous peoples were hardly recognized or not noticed at all. Since then it has worked to support the people in claiming and exercising their rights. The organization's mission is to "support the indigenous peoples of Acre in some of their struggles for the conquest and the exercise of their collective rights – territorial, linguistic, social and cultural – through actions that coordinate territorial and environmental management of indigenous lands, the intercultural and bilingual education and public policy". In this regard, the NGO has a solid relationship with the indigenous peoples of Acre.
3. The National Policy on Environmental and Territorial Management Indigenous Lands – PNGATI – defines *etnomapeamento* as a "participatory mapping of the areas of environmental, socio-cultural and productive relevance for indigenous people, based on indigenous knowledge".
4. FUNAI is the Brazilian federal government's protection agency for indigenous interests and culture funai.gov.br.

## References

- Gavazzi, R.A. 2012a. *Agrofloresta e Cartografia Indígena: A Gestão Territorial e Ambiental nas Mãos Dos Agentes Agroflorestais Indígenas do Acre*. São Paulo: Universidade de São Paulo. [www.teses.usp.br/teses/disponiveis/8/8135/tde-25102012-121716](http://www.teses.usp.br/teses/disponiveis/8/8135/tde-25102012-121716), 13 January 2018.
- Gavazzi, R.A. 2012b. *Etnomapeamento da Terra Indígena Kampa do Rio Amônia: o Mundo Visto de Cima*. Brasília: Edição e Organização – Programa de Gestão Territorial e Ambiental – Comissão Pró-Índio do Acre CPI/AC.

## Illustrations

Map by Pro-Indian Commission of Acre

PERIODO de 13/04/2010. TERRA INDIGEN  
RECURSOS DA ALDEIA NOVA ALIANÇA. AAFI ALDE



A KAXINAWÁ do auto rio Jordão. MAPA de TRABALHO e de uso dos  
 MIR PAULINO PINHEIRO KAXINAWÁ, MANA, DUA BAKE, NI IBU.



LEGENDA.

	Floresta
	CAMINHO
	CASA
	RIO
	Sistema Agroflorestal
	quintais
	BANANAIS
	ROÇADO
	PYAIA
	KUPIXAWA
	ESCOLA
	Piqui de caçada



# Making Cartographies of Ourselves<sup>1</sup>

CRAC Valparaíso – Paulina E. Varas, José Llano Loyola  
cracvalparaiso.org



*“Social ecology will have to work towards rebuilding human relations at every level of the socius.”*

*Félix Guattari, The Three Ecologies*

In April 2014 one of the last great urban-rural fires took place in the city of Valparaíso, Chile. This fire consumed neighborhoods in which more than 3,000 people lived. A few days after the fire we organized, in collaboration with Iconoclastas, a “Collective Mapping Workshop”, which focused on a critical reflection of the ways to present the city from the standpoint of its representatives and subjectivities. It also looked at possible ways to collectively build an integral and binding awareness of the city’s most relevant problems.

The mapping workshop originated from an invitation that we extended to the Argentinian duet Iconoclastas. We organized the workshop in the Cultural Space of Santa Ana, a popular, self-organized community space located in the Cordillera Hill, one of the 44 hills in the city. This self-organized place is situated next to the first building designed as workers’ housing in Chile in 1870 – the Workers Population La Unión, which was restored by its inhabitants in early 2000. Attendance to the mapping workshop was wide and heterogeneous. Participants came from several social, political and cultural areas; students were also represented. For three days we worked on four maps of Valparaíso, using diverse graphic supplies. During this time the main problems of the area slowly became visible; they were associated with the processes of gentrification and privatization of the city versus the counter-culture and self-management organizations.

The debate at the workshop centered around alternative concepts of today’s city – conceiving places where the city is becoming inclusive and democratic in regards to its public and common spaces. The participants conceptualized the “fictions” that the government elaborates at the discursive level in order to sell ideas such as “development” and “innovation” to the citizens. These processes were contextualized in the face of the advancement of a neoliberal city that expands without including them and that, by doing so, creates precarious conditions. We also addressed the progressive weakening – almost the complete loss – of the ties of the Valparaíso citizens with the ocean due to the diverse projects of commoditization and privatization of access. Due to the fire, the workshop also provided a place of encounter in a moment of crisis for many; it was a moment of vulnerability in which people were able to generate action and participation to revitalize links, to make sense of a series of activities that were taking place throughout the city and to support those who were affected by the fire.

One of the results of the mapping workshop and its meetings was a poster titled “Did I invite you to live here?”, referring to the cynic response of the Valparaíso mayor to a claim from one of the victims of the fire. The phrase also reflects forty years of public housing policy in Chile. One of the critical reflections developed was that the current city is the result of policies implemented to support private, financing and speculative sectors, the result of land property and the implementation of subsidies administered by the Chilean state. These subsidies ultimately serve real estate compa-

nies that make a business out of social housing projects. The poster also highlights a series of other problems: The current port is almost completely privatized (86%); the life of traditional popular neighborhoods has suffered from gentrification resulting from real estate speculation; the eviction of neighbors and the privatization of public spaces, giving primacy to the profile of a city built for the eventual visitor. In contrast to this outlook, we identified the presence of cultural, social and communal spaces, the presence of students and teachers, workers and militants, who, along with an alerted, solidary community, meet to think about and activate transformative practices through community self-organization and networks.

After the workshop, a group in Valparaíso worked on systemizing the information of the four maps. We shared this information and talked about ways to formulate vital questions in the collective mapping process. Finally, Iconoclastas worked along with CRAC in designing the map-poster. The poster was printed in Valparaíso and distributed formally and informally throughout the city; it was also plastered on the walls of community and social centers, public offices and faculty offices. CRAC has been invited to present the mapping process at different universities and community spaces. A large version of the poster (more than two meters long) was exhibited in the Museum of Contemporary Art (Santiago de Chile) in the exhibit on art and activism, “The Workers of the Moon”, curated by Loreto Garín and Federico Zukerfeld between November 2014 and January 2015. At that exhibit, we also included a display of slogans from the content of the poster and printed other graphic designs in serigraphy to share it with the participants during the opening event.

### **Future Maps or Maps for the Future**

The workshop has made us aware of the need to create maps which enable us to localize problems and visualize some specific points of reflection on our living conditions in the city. For this reason we have started a new cartography process. This process focuses on developing a cartography of water in its environmental, cultural and social dimension. In Valparaíso the water is running out; shrinking water reserves will create problems in a few years. In the light of this we want to ask, “What kind of life do we want to sustain?” We have already organized a discussion session with a geographer and several interested persons. The next step will be a mapping workshop, using the tools we acquired and the methods we learned in our first experience in order to design a poster that collects the information we want to spread throughout the community. The map will cover the topic of care for life and the alternative ways in which we can design this life in Valparaíso.

*Translation by Carla Guerrón-Montero*

#### **Endnotes**

1. This text has been written on the basis of a systematic account developed by Iconoclastas. It can be found on the following page: [iconoclastas.net/valparaiso-chile](http://iconoclastas.net/valparaiso-chile)

## CRITICAL COLLECTIVE CARTOGRAPHY OF VALPARAISO

# “DID I INVITE YOU TO LIVE HERE?”

The major of Valparaiso responded with this phrase to the claims of one of the persons affected by the fire in April, which took away housing from thousands of people living in the hills. This cynical response summarizes the attitude of successive governments, which have transformed the city to the tune of private, financial and speculative benefits, tied in particular with the interest of port holdings and the tourism business. This “Valparaiso for others” is evidenced in the imposition of lifestyles based on consumption with high purchasing power for some, and the precarization of work for the majority. Life in former popular neighborhoods has been affected by processes of gentrification resulting from real estate speculation, the expulsion of neighbors and the privatization of spaces for public use, privileging the profile of a city built for the eventual visitor.

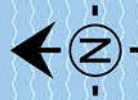

### 1 Behind closed doors

88% of the port sector is privatized since Pinochet's dictatorship. This implies that, from the immense flux of commodities and capital that circulates through it, the city only receives minimal benefits. Artisanal fishery was replaced by precarious and poorly remunerated work. The spaces of popular use were either closed or restricted and were oriented to touristic consumption.



### 3 The mall of many

The Barón pier and its surroundings are threatened by a real estate speculative project with high social and environmental impacts. This includes the construction of a mall in the coastline, in a zone at risk of flooding, its construction will foment the destruction of common heritage, the deterioration of the landscape and the expulsion of informal businesses, which provide basic subsistence to thousand of families.



### 5 A history that repeats itself

The magnitude of the fire that took place last April 12, which caused the tragic death of 15 persons and the loss of more than 12,000 homes could have been avoided. This situation evidenced the discrimination with which the government treats certain sectors, as well as its indolence because—knowing the risk of potential fires—did not adopt preventive measures such as installing fire tanks or cleaning garbage dumps.



### 2 Valpo Hill

The main touristic cultural zone of the city is located at the foot of the Concepción and Alegre Hills. This zone developed as a result of a speculative process that used communal land for private purposes.

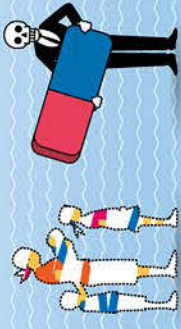

### 4 Level of invisibilization

The road Curicura and Alemania Avenue divide the city in two opposing realities. Beyond the limit, and as the level increases over one hundred meters, the landscape that dominates is one composed of garbage and lack of infrastructure and basic services such as a sewage system, potable water, electricity, and gas. The lack of interest of the government to improve the quality of life of its inhabitants is notable.



### 6 The gun powder of the Changos

This is one of the oldest roads and it is characterized by expulsion and neglect by the state towards its inhabitants. Precarious homes are built over land surrounded by garbage. Families survive on informal work; the lack of public transportation limits or hampers their movement due to work or health reasons.

AMENAZA LATENTE:  
pese al rechazo  
de la UNESCO



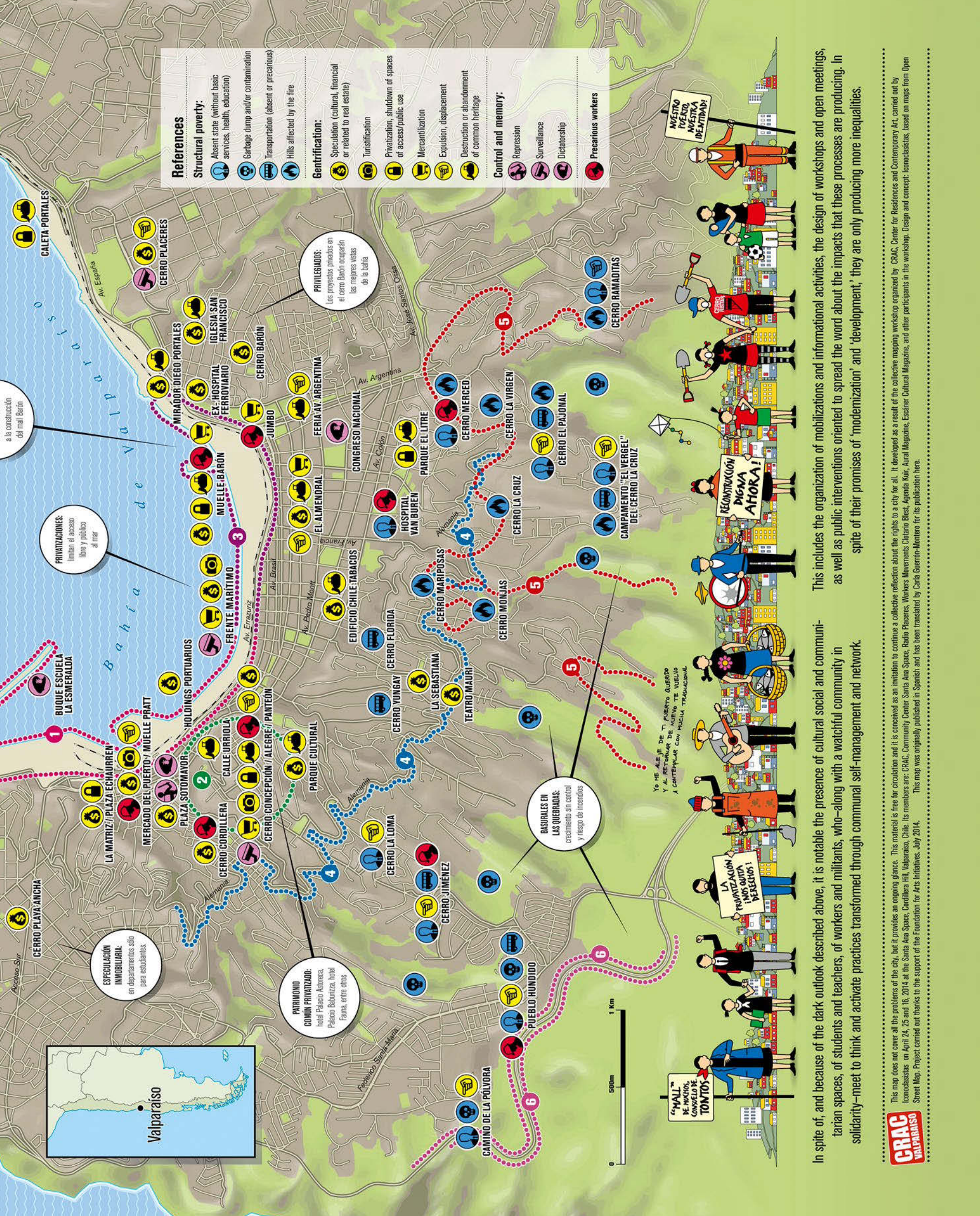

- References**
- Structural poverty:**
    - Absent state (without basic services, health, education)
    - Garbage dump and/or contamination
    - Transportation (absent or precarious)
    - Hills affected by the fire
  - Gentrification:**
    - Speculation (cultural, financial or related to real estate)
    - Touristification
    - Privatization, shutdown of spaces of access/public use
    - Mercantilization
    - Expulsion, displacement
    - Destruction or abandonment of common heritage
  - Control and memory:**
    - Repression
    - Surveillance
    - Dictatorship
    - Precarious workers

PRIVATIZACIONES:  
limitan el acceso  
libre y público  
al mar

ESPECULACIÓN  
INMOBILIARIA:  
en departamentos sólo  
para estudiantes

PATRIMONIO  
COMÚN PRIVATIZADO:  
hotel Palacio Asturica,  
Palacio Baburizza, hotel  
Fauna, entre otros

PRIVILEGIADOS:  
Los proyectos privados en  
el cerro Barón ocuparán  
las mejores vistas  
de la bahía

BASURALES EN  
LAS VUEBRADAS:  
crecimiento sin control  
y riesgo de incendios

YO HE ALEJADO DE TU PUERTO QUERO  
Y AL RETORNAR DE NUEVO TE VUELVO  
A COMENTAR CON MUCHA TRANSCENDENCIA

In spite of, and because of the dark outlook described above, it is notable the presence of cultural social and communitarian spaces, of students and teachers, of workers and militants, who—along with a watchful community in solidarity—meet to think and activate practices transformed through communal self-management and network.

This includes the organization of mobilizations and informational activities, the design of workshops and open meetings, as well as public interventions oriented to spread the word about the impacts that these processes are producing. In spite of their promises of 'modernization' and 'development', they are only producing more inequalities.

# A Civic Mapping Project in an Indian Megacity

## The Uses and Challenges of Spatial Data for Critical Research

Hyderabad Urban Lab – Harsha Devulapalli, Indivar Jonnalagadda

hydlab.in

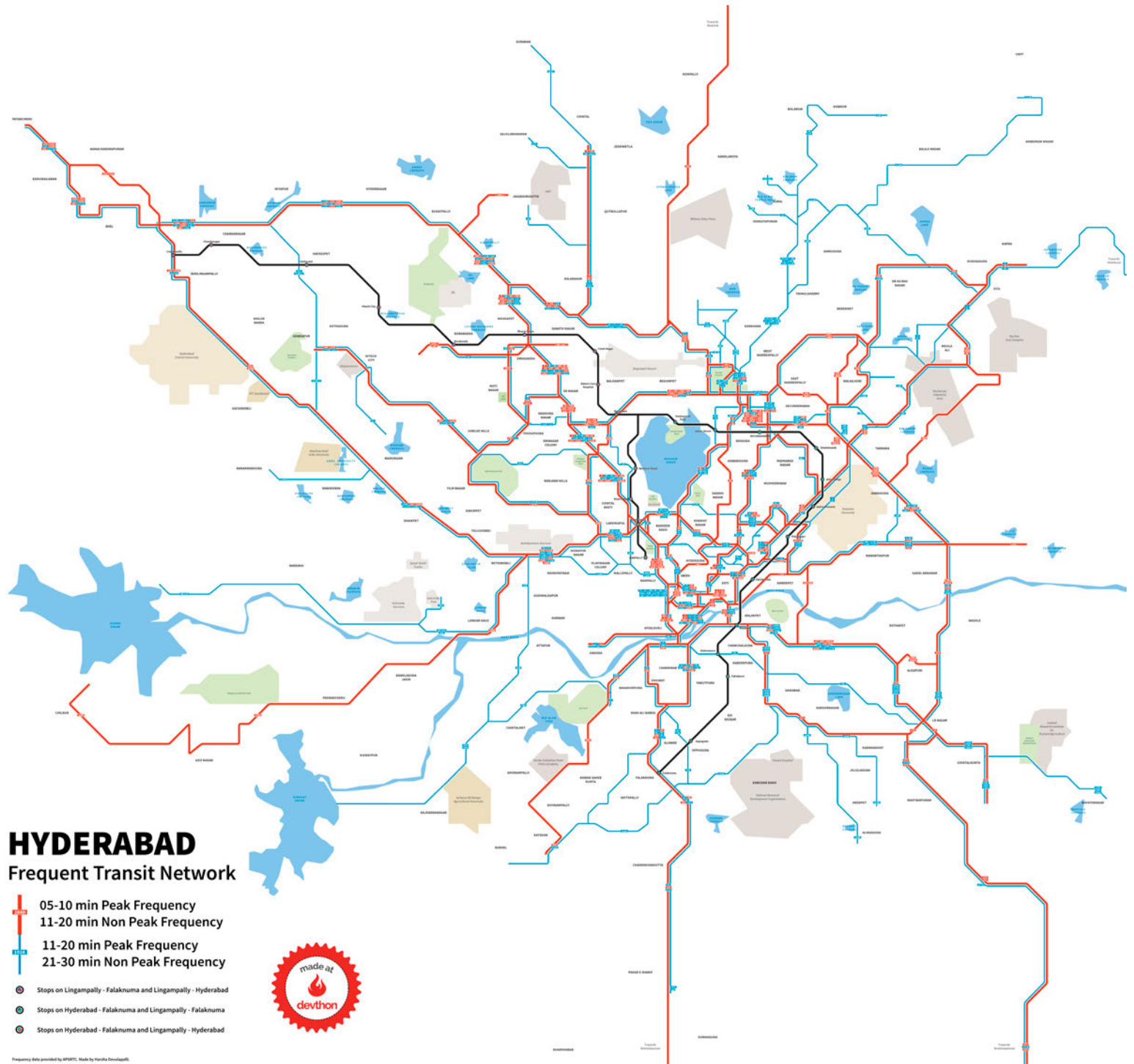

## IMPRESSIONS OF THE MEDIA VS LOCAL PERCEPTIONS OF BHOLAKPUR

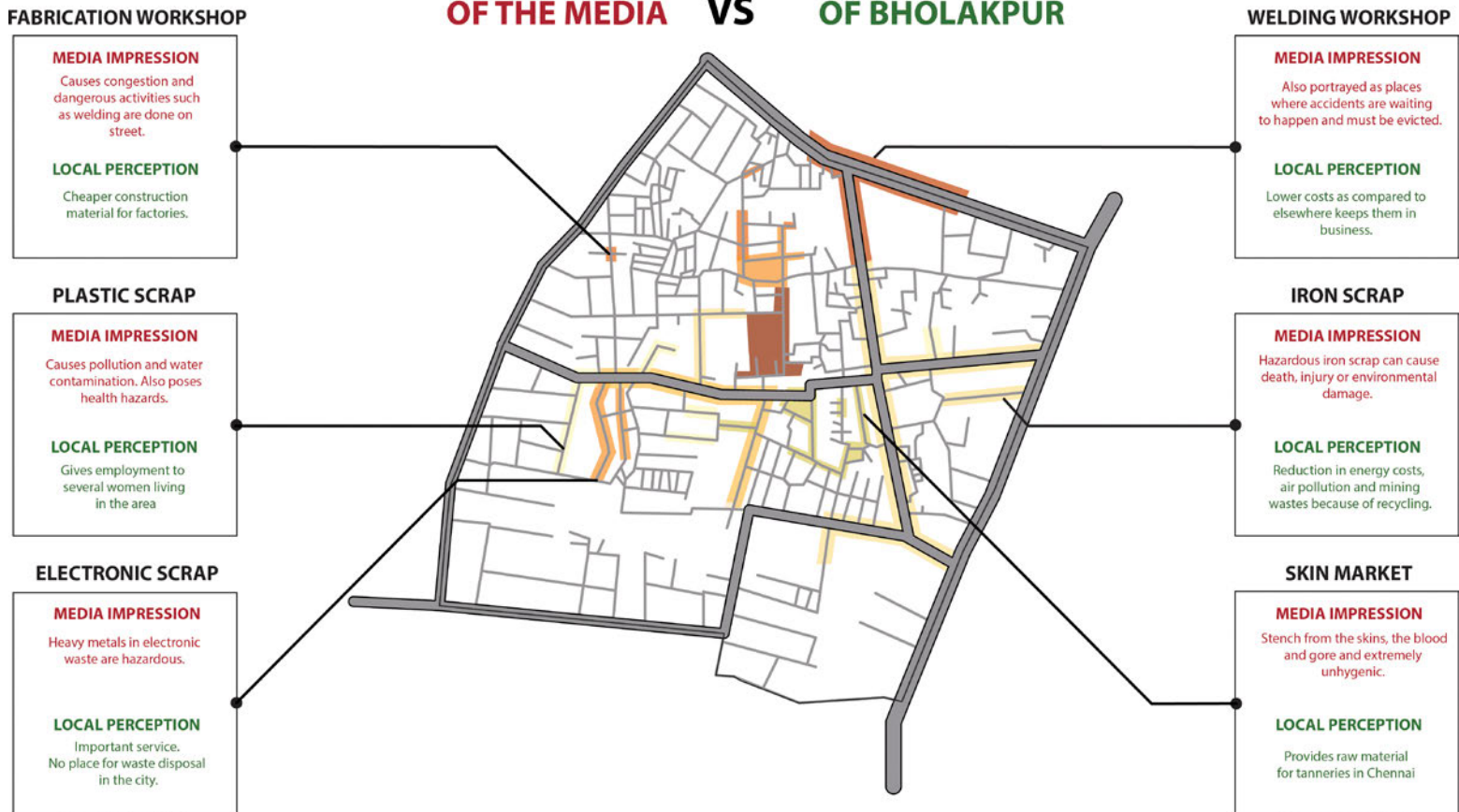

Hyderabad Urban Lab (HUL) looks at cities as a complex set of relationships consisting of relations of production, social relations and relations between citizens and governments. HUL began in mid-2012 with the aim of conducting research on urban issues in a way that would bridge the gap between academic urban research and life at the grassroots. Since the beginning, HUL has experimented with cartography and connected this to both research and pedagogy. HUL makes maps but also advocates to both the government and citizens for a richer cartographic engagement within the city. Over the years HUL has held mapping workshops with a variety of stakeholders and even schoolchildren.

Occurrences in cities are the result of numerous relationships coming together at multiple scales of space and time. As Dennis Wood (2010) says, one can portray these intersections by bringing things together on a common level. It is this level and the propositions that make the map. As Peter Turchi (2004) puts it, maps are no different from literature in the sense that they attempt to explain human realities. It is the cartographer's privilege to select what is included and what isn't. Thus maps in general are assertions of the state of the world which cartographers desire. This is why maps are tools of power. The state, which in many countries holds exclusive rights over mapping, can choose to portray certain versions of reality while omitting others. Corporations with large amounts of spatial data also hold great power over the way the world is increasingly being perceived and

experienced through digital maps. In this context, practices of critical mapping stand outside the norm of using maps to declare sovereign power or to facilitate consumption. They, in fact, talk back to this power and help citizens or communities to represent their own geographies.

Since its inception, HUL has used critical mapping as a core methodology in research, a key tool in engaging with various urban stakeholders and also as an essential component of its pedagogic outreach. Having undertaken a wide variety of mapping projects and teaching workshops, our practice itself has deepened rigorously. Here we present, with examples from our work, four of our key mapping practices, the principles that direct them, the practical difficulties we face and the reasons why we are committed to working with open data and crowd-sourcing.

### Community Mapping Maps of Bholakpur's Scrap Markets

HUL's earliest project was to build a digital tool in order to enable collaborative research with the community in a historic neighbourhood called Bholakpur – a former hub of leather tanneries and today a hub of scrap markets. The motivation was to understand the political economy of the markets and also to revalorize the neighbourhood in terms of its dynamics and economic productivity, something the government has been neglecting.

Members of the community responded eagerly and played a major role in facilitating the process. They helped us to collect GPS tracks and to identify the key objects represented on the map. The community members quickly understood the usefulness of the map and also that they had taken ownership of it. The idea that community mapping might be an empowering process was affirmed by maps drawn to contest the government's view of Bholakpur.

Taking ownership of these maps also enables the community to make claims on their own knowledge of the place. Bholakpur's scrap markets have been facing pressure from the government and are threatened with eviction. This pressure is a result of popular perceptions regarding persistent water contamination in the area and its connection to the presence of the scrap market. With the help of maps, local field workers are able to identify specific locations in the neighbourhood in which contamination is persistent. This data can then be collated with the locations of scrap processing units and their runoff. The spatial data was able to demonstrate that there was little or no correlation between water contamination and the presence of scrap markets. An ability to work with maps and spatial data has given residents of the neighbourhood leverage in negotiating with governments and NGOs that work in the area.

### **Crowd-Sourcing Data – Bus Frequency Map**

The Andhra Pradesh Road Transport Corporation (APSRTC) runs most of the city buses in Hyderabad but does not have a public database of all bus routes and time schedules in the city. After extensive cleaning of a rather faulty list of bus stops and bus routes acquired from the APSRTC, the result was the first geospatial database of bus routes in Hyderabad.

The map generated from this database is useful for citizens but it also helps us to understand areas in the city that are deprived of public transportation. With this base map, we asked: How do people travel in areas with no public transportation available? We presumed that the answer was represented in shared auto rickshaws. As an experiment, we put out a public call for people to contribute shared auto rickshaw routes that they knew of. Within 8 hours, we had details on 85 routes in the city. Adding all of these routes to the existing frequency network map further enhanced the public database on mobility in Hyderabad.

### **Public Audits Using Maps – Map of Public Toilets**

Public audits and fact-finding missions have long been a useful methodology employed by activist groups and other civil society organisations in India for holding the government accountable for the rights of citizens. We believe that the addition of maps as a tool will be invaluable to this methodology.

The current government of India announced that sanitation would be one of its priorities. While the government was targeting the people's attitude towards defecation in public, we published our map in order to put these attitudes in the context of the avail-

able infrastructure. Hyderabad, a city of more than 6 million people, has only 186 public toilets. Our map highlights the unjust and sparse distribution of toilets in the city. Another focus of our dynamic map is to show the inequality between available toilet facilities for men and women. The data was collected through a public audit conducted by the HUL team and some volunteers.

Our map also illustrates the perverse outcome of an incentive for free advertising on the outer walls of toilets provided to private contractors if they built new public toilets. As a result, 50 new toilets were constructed. However, many of them were located in squares which were already served by a public toilet; sometimes they were built just adjacent to old ones while leaving many areas of the city still unserved. Perplexed by this choice of location, we supplemented our mapping exercise with an audit of some of these toilets. We found that the incentive structure meant that private contractors built toilets where their visibility as billboards would be greatest. Although the incentive had been offered with good intentions, poor monitoring of the outcomes resulted in inadequate, sometimes redundant results with respect to the goal of expanding access to public toilets. Many of our mapping exercises are conducted in this audit modality with which we hope to be able to persuade the government to plan public amenities and implement policies with greater care.

### **Cleaning up Public Data Atlas of Slums in Hyderabad**

Most cities in the developing world such as Hyderabad tend to have data in closed and archaic formats which impede interoperability. They also lack inventories to keep stock of multiple data sets across space and time (e.g. it is hard to find any data on pre-1990 municipal wards for Hyderabad). The periodic realignment of administrative boundaries and enumeration blocks makes it especially hard to build cohesive data sets over time. Uncertainty about data rights is another major problem. These issues often represent obstacles for anyone interested in doing research in these cities.

In a bid to transform Hyderabad into a "slum-free city" (real world-class city), the city government was going to conduct a count of all the slums in its jurisdiction, which amounted to 1476. As is common, this task was outsourced to a private company. Unbelievably, the task was conducted within 30 days and with a budget of just 1.8 million rupees (roughly 23,000 Euros). We highly question the validity of this information and the legitimacy of how the data was collected. In any case, some data was produced. Although there are some glaring inconsistencies, the map gives us the only available representation of slums in Hyderabad, and, more importantly, this is a representation of how the government itself sees the "slumscapes" of the city.

An atlas of maps depicting various characteristics of recognised slums in Hyderabad was put together through a painstaking process of cleaning this inconsistent data. By sharing these maps with the government, we wish to inform it about the possibilities for analysis and planning offered by clean spatial data. Through

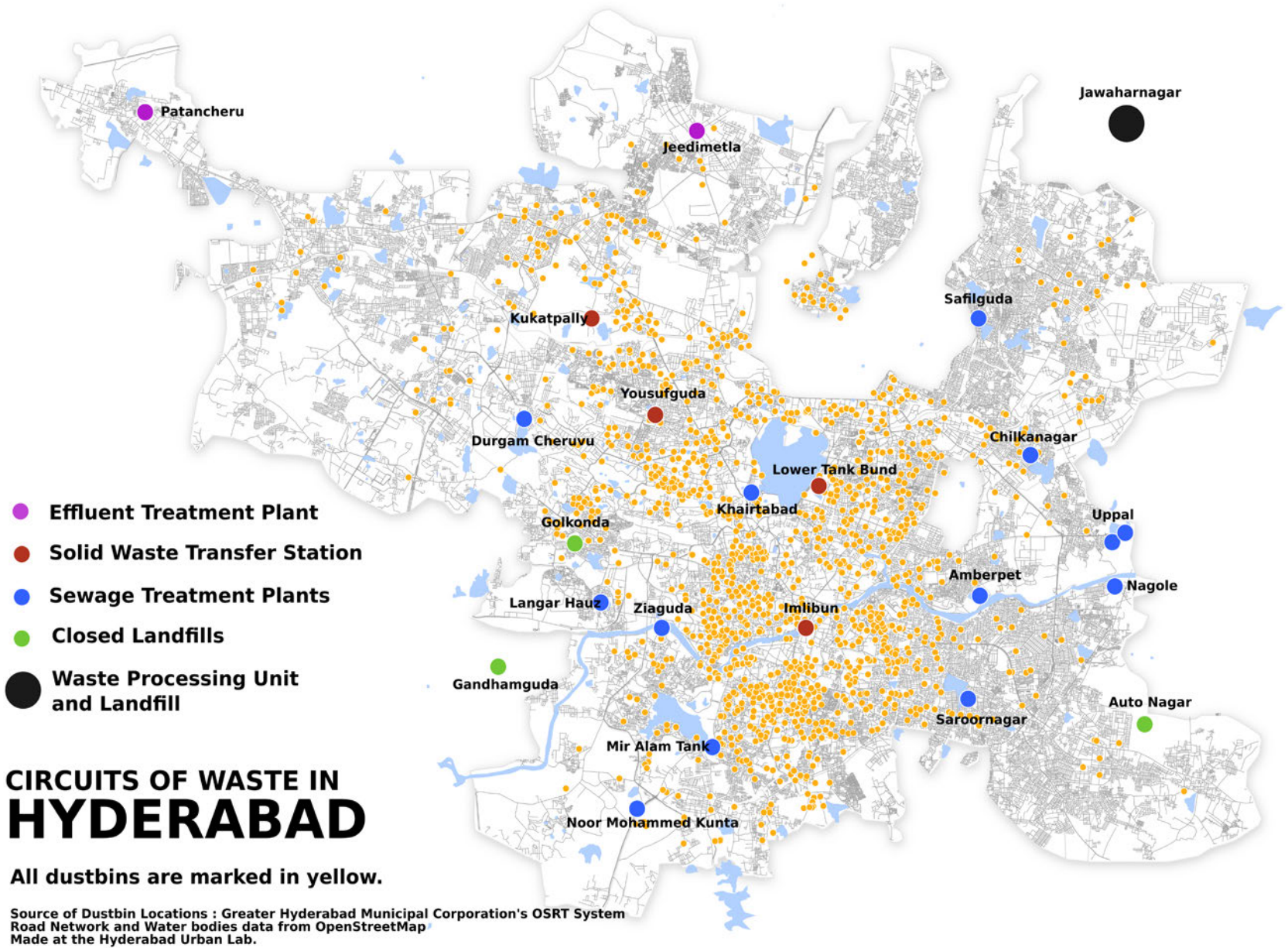

regular articles and interventions at consultation meetings, we are trying to push the government towards improving their data practices. This is a long-term project because we believe that apart from civic mapping projects, public data itself should be publically accessible in general.

### Conclusion

Being in the open domain, our maps have constantly elicited new questions and new proposals from the citizens looking at them. It is evident that the general ethos to support the fruitful use of open data as well as the employment of crowd-sourcing practices is already happening in our city. With each new project, we try to tap into that ethos. With each workshop, we try to further encourage it. With each engagement, we try to extend the conviction that planning cities can be a more democratic exercise.

### References

- Turchi, P. 2004. *Maps of the Imagination: The Writer as Cartographer*. San Antonio, Texas: Trinity University Press.
- Wood, D. 2010. *Rethinking the Power of Maps*. New York: The Guilford Press.

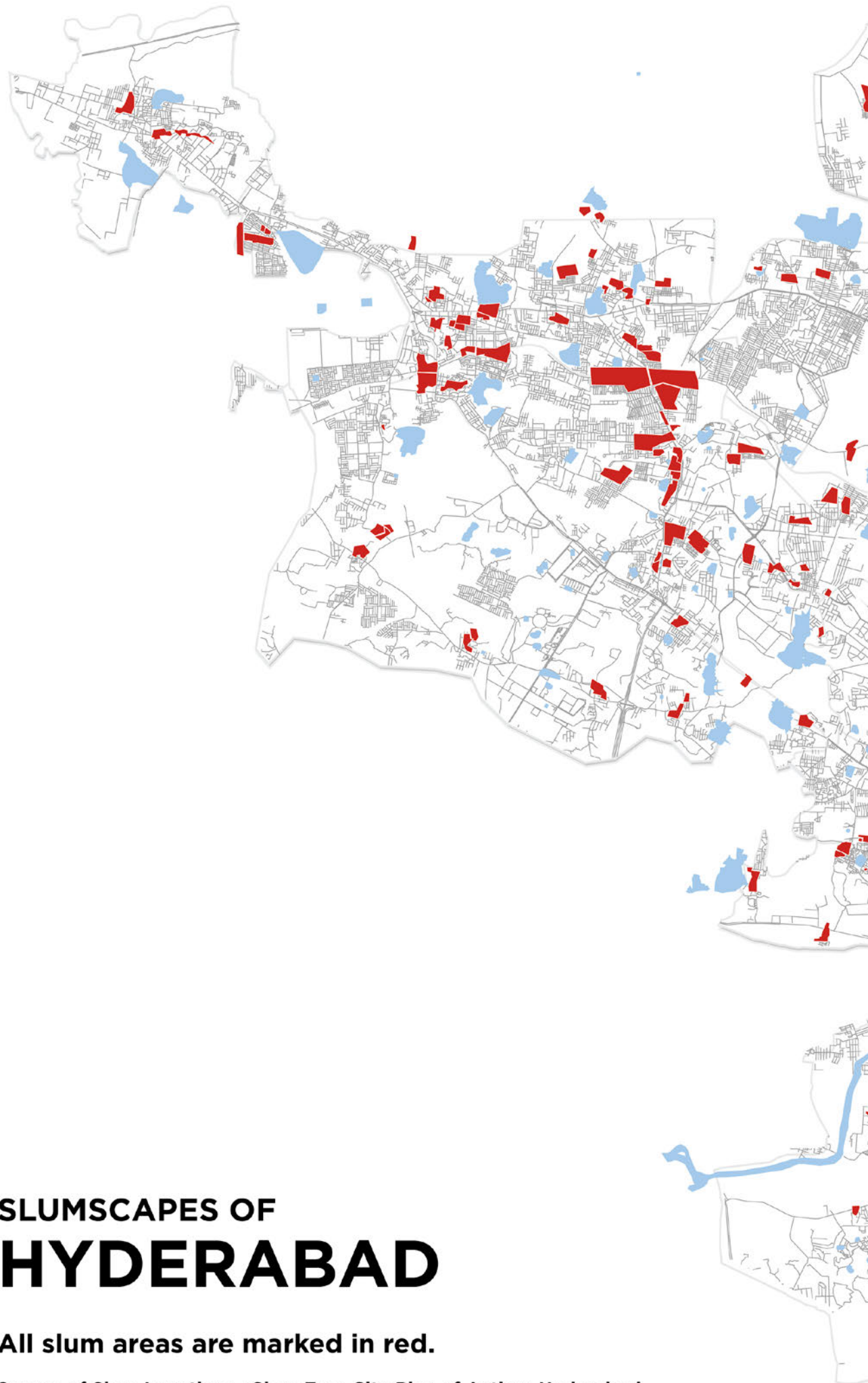

# SLUMSCAPES OF **HYDERABAD**

All slum areas are marked in red.

Source of Slum Locations : Slum Free City Plan of Action, Hyderabad  
Road Network and Water Bodies Data from OpenStreetMap  
Re-made at the Hyderabad Urban Lab.

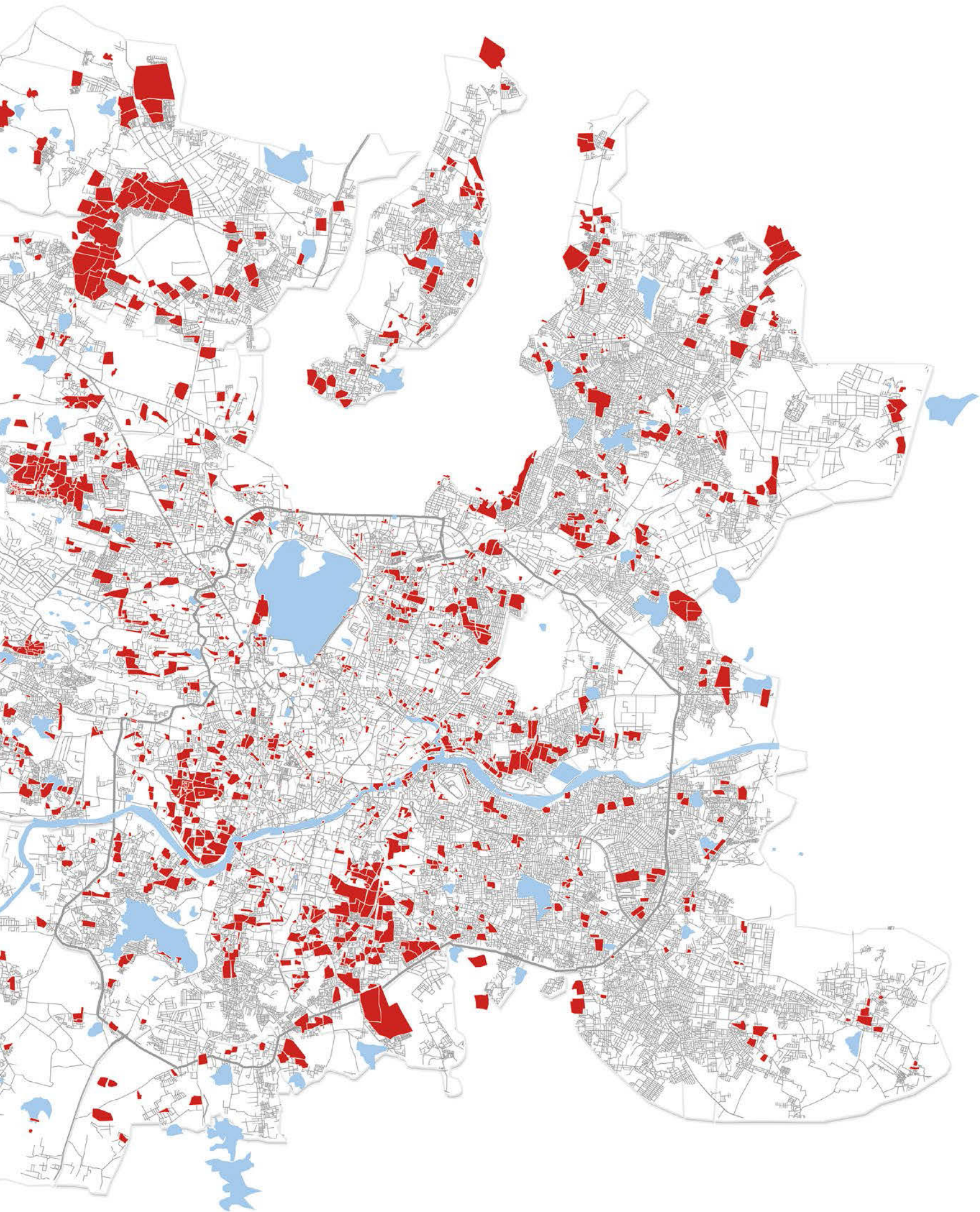

# Mapping Sexual Harassment in Egypt

HarassMap team – edited by Noora Flinkman

harassmap.org/en

The screenshot displays the HarassMap website interface. At the top, there is a teal navigation bar with the text "REPORT LOGIN / REGISTER". Below this is the HarassMap logo and tagline "Stop sexual harassment, together". A secondary navigation bar includes "ABOUT", "OUR WORK", "RESOURCES", and "TAKE ACTION". The main content area features a map of Egypt with various cities labeled in Arabic and English. Red circular markers indicate the number of incidents in different areas, with the highest concentration in the 6th of October City (1174). A legend at the bottom of the map distinguishes between "Incident" (red circle) and "Incident with intervention" (teal circle). Below the map, there are two prominent buttons: "REPORT AN INCIDENT" in red and "REPORT AN INTERVENTION" in teal. Further down, three icons represent "Learn the basics", "Share your story", and "Get active", each with a brief description. At the bottom, there are sections for "WEEKLY TIP" and "YOUR STORY", with a "READ MORE" button.



Women everywhere experience sexual violence in public – from ogling, comments and catcalls, online harassment, touching and stalking, to sexual assault and rape. Sexual harassment in particular is an everyday struggle that Egyptian women have to endure, and in many cases accept, while going about their daily life. It is often seen as a trivial matter with few or no consequences and as the women's own fault. Not acknowledging the responsibility of perpetrators as well as its impact on women's perceptions of themselves and their role in society.

Sexual harassment is misunderstood and underreported all over the world. Stigma and shame prevent many women from talking about it or reporting it, and data on the problem is scarce. New web and mobile technologies have, however, opened up possibilities to overcome some of the barriers to documentation and data collection on the issue. HarassMap's reporting and mapping platform, which has become a key tool for generating data and providing the public with an alternative way to report sexual harassment, has had great success in bringing about debates and discussions about the issue in Egypt and worldwide.

## The Map

HarassMap's map utilizes web and mobile technologies to crowdsource incidents of sexual harassment from all over the country. Individuals who either experience or witness sexual harassment are able to anonymously submit reports directly through the web interface or through Facebook and Twitter, provided that the report includes some basic mapping criteria – including location and date/time of the incident – the reports are automatically mapped using Google Maps and made publically available on the HarassMap website. Each report appears on the map as a red dot that, when clicked, displays the full information of the report in its original language (Arabic or English). Each report includes not only the location and the date/time but also a text description of the incident, the type(s) of sexual harassment (for example comments, stalking or following). Sometimes it also contains additional information on the age or educational level of the reporter and harassed person and whether or not witnesses who intervened are included. Each report receives a response with information on how to access free legal services and psychological counseling.

The data on the map is open for anyone to view and use and serves multiple functions. This includes providing testimony by those who experience or witness sexual harassment as to the seriousness of the problem, serving as data for understanding how sexual harassment is evolving in Egypt, providing HarassMap with information that can be used to tailor communication campaigns and educational programs and serving as a tool to motivate the public to report and stand up against sexual harassment. Immediately after launching the map in 2010, HarassMap received a large number of reports of sexual harassment, and over the years the crowdsourced data has helped to reformulate the discussion on sexual harassment in Egypt. It has also helped to challenge stereotypes and misinformation about the issue.

## Sexual Harassment: How Effective Is Crowdsourced Data?

Crowdsourcing has emerged as an exciting new method for data collection yet its efficacy remains poorly understood. In 2014, HarassMap published a study<sup>1</sup> that investigated the strengths and weaknesses of crowdsourcing tools, such as its own reporting and mapping platform as a data collection method, comparing it to traditional data collection techniques, such as questionnaires, focus groups and interviews. The study suggests that online reporting and mapping can be an effective alternative for data collection on sensitive issues such as sexual harassment.

The findings show that accounts of sexual harassment reported on a map often provide a much more striking picture of the problem than those derived from in-depth interviews, for example. Map reports are bolder, with individuals providing more information about their experience of sexual harassment than they did during interviews. With regard to language, sexualized words and phrases that might cause discomfort in a face-to-face interview setting with an unknown interviewer are much more prominent in the map data.

Reports received via the map are also fuller and more comprehensive than in the interviews, which may suggest that people are more willing to speak about the issue anonymously online than in person. The map narratives exhibit a recurring four-part structure characterized by 1. a set-up of the scene, 2. details of the sexual harassment itself, 3. the response of the harassed individual, and 4. the moral (offering public comments on sexual harassment in Egypt in general). This structure was not seen in the in-depth interviews, in which shorter question and answer exchanges were more common than extended narratives. What's more, while "milder" types of sexual harassment, such as catcalls and ogling, were the most common forms of harassment discussed during in-depth interviews, touching, physical assault and rape were the most commonly reported types in map reports. This may represent a major advantage of the map over traditional methods, as it offers a space in which individuals can speak relatively freely and without judgment – making people more willing to discuss sensitive issues and painful experiences, such as sexual harassment or assault. HarassMap is based on the idea that if more people start taking action when sexual harassment happens in their presence, we can end this epidemic.

## Endnotes

1. HarassMap (2014). Towards a Safer City – Sexual Harassment in Greater Cairo: Effectiveness of Crowdsourced Data. [harassmap.org/en/wp-content/uploads/2013/03/Towards-A-Safer-City\\_full-report\\_EN-.pdf](http://harassmap.org/en/wp-content/uploads/2013/03/Towards-A-Safer-City_full-report_EN-.pdf), 6 May 2017.

## References

- Fahmy, A., Abdekmonem, A., Hamdy, E. & Badr, A. 2014. *Towards a Safer City - Sexual Harassment in Greater Cairo: Effectiveness of Crowdsourced Data*. [harassmap.org/storage/app/media/uploaded-files/Towards-A-Safer-City\\_executive-summary\\_EN.pdf](http://harassmap.org/storage/app/media/uploaded-files/Towards-A-Safer-City_executive-summary_EN.pdf), 5 June 2017.

## Illustrations

authors map

idea: Rebecca Chiao, co-founders and volunteers

design & illustration: Piero Zagami and Noora Flinkman

content: anonymous reporters

Manshiyyat Al Qanatar  
منشبه القناطر

Al Qanatar Al Khayriyyah  
القناطر الخيرية

### Incident with intervention happened on 18/10/2017 at 1:00AM

at LB, Hurghada, Hurghada, Cairo (30.044420 31.235710)

A men touched my butt while i was trying to catch my bag before leaving the club (L B) at Hurghada. I looked at him very angry and starting to shout at him, my friend (a men) came and told the guy that this was very inappropriate and deserve my shouting. His only answer was "i'm with my wife, i swear i never did that ". So basically, the bouncer (another men) obviously, trusted the "victim" men and i was asked to leave the club. I was the one hysteric girl disturbing the "atmosphere" and he was the poor little guy trying to have fun with his wife. I was shocked and he was free...whatever, sick society, sick world..

✓ 10 expressions of support.

EXPRESS SUPPORT

ADD COMMENT

VIEW MORE REPORTS

READ MORE

Categories Touching

Intervention Offered assistance to harassed person proactively Expressed sympathy with the harassed person

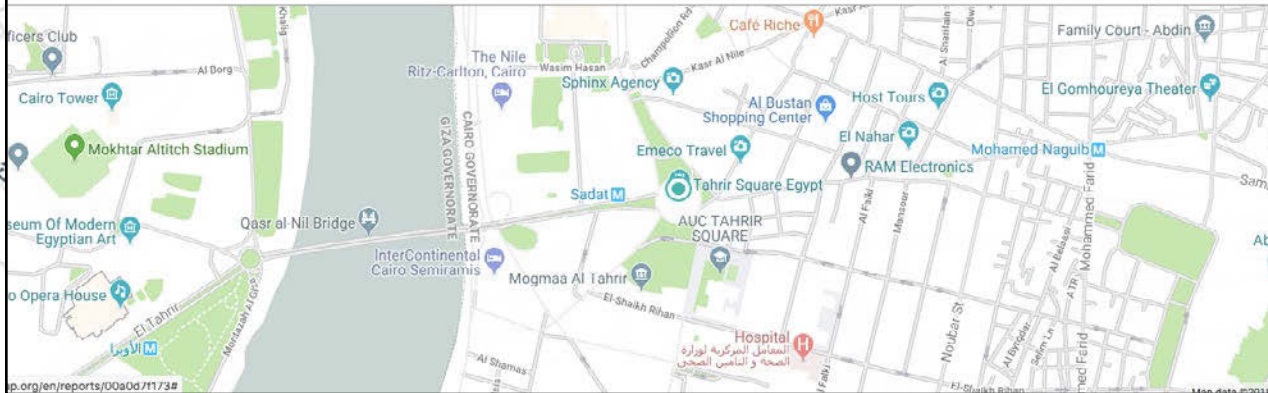

3



ABOUT OUR WORK RESOURCES TAKE ACTION

### REPORTS

DATE	TYPE	DESCRIPTION	LOCATION	CATEGORIES
02 / 04 / 2016	●	...لأول مرة أمسك متحرش كان قاعد جيمى فى الميكروبوس ال	ميكروبوسات النيل , المحطة , شارع الشواربم, أسوان, أسوان	Touching
02 / 03 / 2016	●	...انا من سكان شارع بشنيل بمنطقة المنيرة الغربية الج	عمارة الوباب عند موقف الميكروباوس, منطقة بشنيل, الجيزة, الجيزة	Facial Expressions, Ogling
01 / 03 / 2016	●	something	somewhere, Qalyubia	Ogling, Comments
10 / 02 / 2016	●	I was walking with a friend on Tahrir square, clos...	Tahrir square, next to AUC campus, Downtown,, Cairo, Cairo	Comments
10 / 02 / 2016	●	He said comment on my boobs and said a disgusting ...	Kornish Tahrir st., dokki, Giza, Giza	Sexual Invites
09 / 02 / 2016	●	...كنت خارجة من الشغل ومستقبة تكتسى, وواحد عدى بموتوسي,	الكورنيش, العجوزة, الجيزة, الجيزة	Comments
08 / 02 / 2016	●	...اسمي غاده و عبرى ١٥سنه اثناء وجودى الساعة العاشر	عزيزه النخل, القاهرة, القاهرة	Touching

● Incident

● Incident with intervention

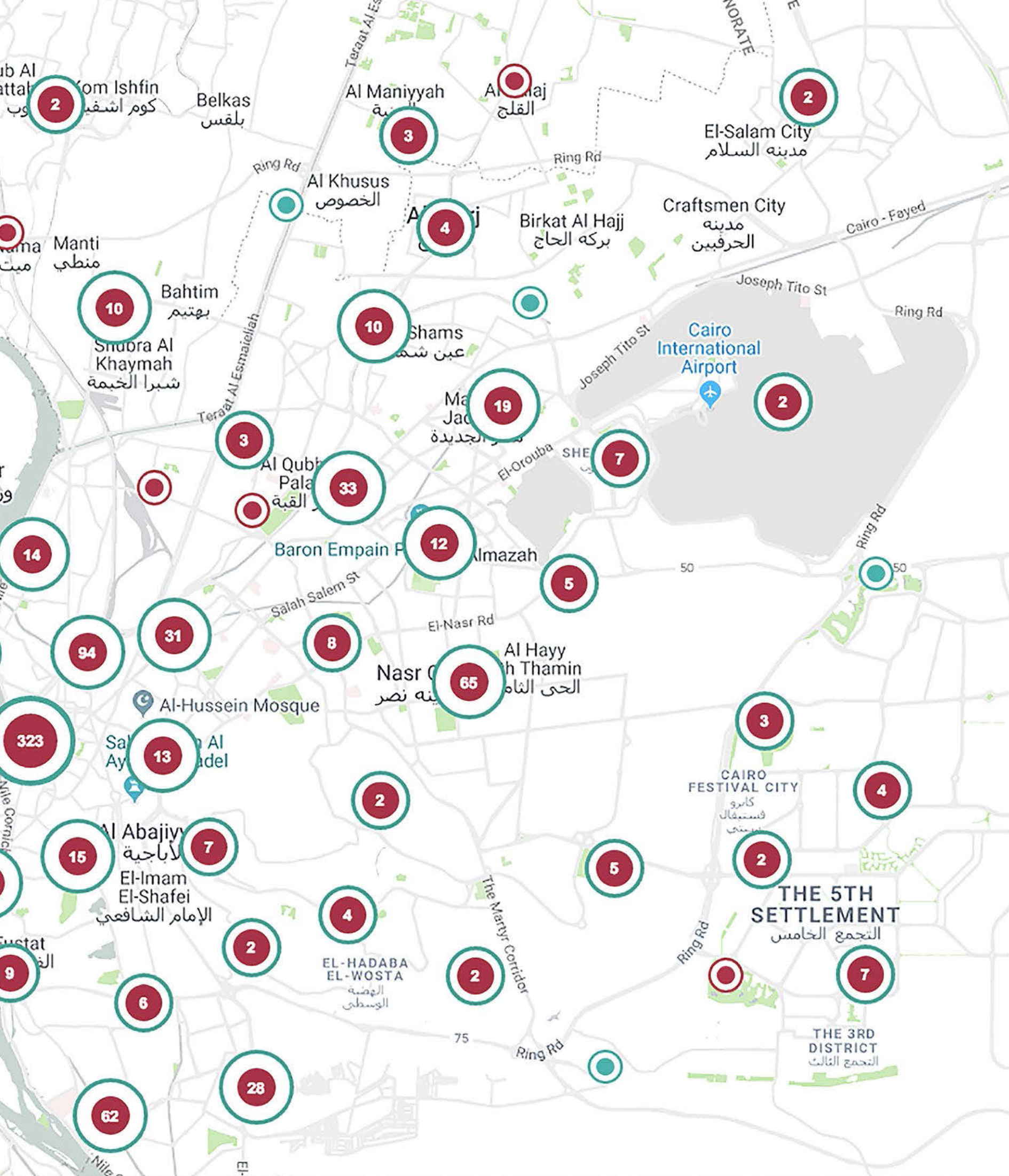

**FILTER**



# Untangling the Strategies of Capital

Towards a Critical Atlas of Ecuador

Colectivo de Geografía Crítica del Ecuador

[geografiacriticaecuador.org](http://geografiacriticaecuador.org)



Ecuador's Critical Geography Collective emerged in 2012 as a result of a happy encounter among geographers, social scientists and activists concerned with answering theoretical and practical questions about growing territorial tensions around the country. Even though Ecuador has had one of the most advanced constitutions in the world since 2008 pertaining to the rights of indigenous peoples and communities<sup>1</sup>, the government's promise to put these rights into practice in this post-neoliberal period has not come to fruition. Actually quite the opposite has been the case. The abuse of collective rights and invasions of indigenous, Afro-Ecuadorian and peasant territories have dramatically increased. In contrast to the previous neoliberal period, the state has become the protagonist in this process while legitimizing a discourse that justifies the arbitrary and violent expansion of its territorial mesh in the name of a supposed national interest and in association with capitalist interests.

In constant dialogue with authors who represent Latin American critical geography, our analyses and practices break with the hegemonic perspective which proposes the state as the only agent of territorial regulation: In contrast to this hegemonic perspective, we recognize other social actors as legitimate agents of regulation concerning their own lives as well as reproductive spaces. We denounce the arbitrary violation of rights carried out during the current political period. In fact, our actions are based on the perception that the so-called legitimization of territorial regulation is actually always accompanied by its opposite: the deregulation of organized territories based on different logics and different feelings, in connection with nature as well as human beings. In this matter, geography is understood only as "technical" and – supposedly neutral – knowledge. However, in practice it is tightly bound to a territorial "regulation" that defends the rights of capital interests. The Critical Geography Collective has hereby become a space of formation, research and denouncement, profoundly compromised with resisting the capitalist model of the plundering and degradation of nature and indigenous peoples.

Our work is characterized by its collective and dialogic nature, which we try to achieve through permanent discussion and complementarity between our capacities and interests. These are of theoretical, cartographic and communicative nature. They also include other related research. We initiated a series of activities throughout the last four years by associating the use of cartographic tools with theoretical and political reflections in a critical matter. The activities included the following: collective readings and reflection of classic and contemporary writings in critical geography; training on tools for community mapping; research on the background and impact of public policies and laws connected to state territorial regulation; public denunciation of projects connected with capital interests through manifestos and press conferences in order to demystify and problematize the official discourse; organized conversations with national and international guests in order to disseminate other experiences of resistance as well as our own research projects; cartographic simulations of the effects extractivist projects have on invaded territories; finally we tried to generate support, cartographic production and political analyses of the criminalization of protests in Ecuador.

The accumulation of the experiences mentioned as well as the individual research projects and activist work of each member

of the collective have greatly contributed to shaping our former project of building a national critical atlas<sup>2</sup>. Through surveys, systematization, analysis and cartographic representation of different variables at the local and national level we aim to understand the complex dynamics of territorial tensions around the common goods in Ecuador. This includes the actions of businesses and the state itself, as well as the discourses developed by the state to legitimize the invasion of the indigenous peoples' territories. We also try to focus on the relation of communities with their territories. The idea is to analyze a base of 25 territorial conflict cases and



thereby create a systemic and critical reading of the tendencies and strategies of capital in their concrete materialization<sup>3</sup>. This information can then also be articulated within a broader geopolitical context. This allows for reflection about the mode in which capital interests are territorialized in the country. It also generates inputs for resisting communities. Likewise, the construction of the Atlas aims to visualize the latent conflicts generated by the expansion of the territorial mesh of the state. Hereby it shows and explicitly denounces aspects which are generally hidden or mystified by the governmental discourse of local development and national interests.

In addition to a few composite maps and explanations about the general context, we have worked specifically on each of the aforementioned cases. The case of oil exploitation in the Yasuní National Park, located in the Ecuadorian Amazon, is perhaps the most emblematic of all. It surely is the most dramatic in terms of the abuse of constitutionally recognized territorial rights in the name of the myth of national development and, in this case, the myth of the Amazonian demographic void<sup>4</sup>. The map "Record of Incidents with Indigenous Peoples in Isolation in Waorani Territory and the Yasuní National Park" explains the territorial conflicts alive in the zone: One can see the complex superposition of the Intangible Zone Tagaeri-Taromenane (ZITT, indigenous peoples in voluntary isolation), the Waorani territory (recently contacted peoples), the state's political-administrative division and the protected area of the Yasuní National Park. In fact, more than latent, it is a case of manifested conflicts, in which the killings among indigenous peoples shows the cruelest side of the consequences of territorial pressure and environmental and social unbalances.

These unbalances are generated by the expansion of extractivist activities and the resulting infrastructure in and colonization of these territories.

As part of the "Cartography to Not Forget", we presented the map of detentions and militarization of the country apropos the National Strike in August 2015. This map shows the repressive strategies of the Ecuadorian state in response to resistance<sup>5</sup>. Organized by the indigenous movement and rural and urban workers, the strike has been heavily repressed by the Ecuadorian state, through the use of forceful invasion, detentions, aggressions and other violations of human rights. Even though – according to our analysis – direct violence is not the main repressive strategy of the state<sup>6</sup>, the criminalization of protests has grown brutally in the country throughout the last years.

While we respond to specific demands that emerge in the making, we are currently in a phase of reflection about the primary and secondary data generated during the creation of the Atlas. Based on the questions and observations that developed during the first stage, we are currently analyzing some specific themes and challenges: the transversal insertion of the feminist outlook in this analysis, how to guarantee that the material we produce strengthens the community's social fabric and struggles, and how to characterize the post-neoliberal state in a more precise manner. More than a goal itself, the Atlas has become a means to rethink and strengthen our actions as a collective. It has also become key in building up our capacity to develop a dialogue with and support of resistance struggles.

*Translation by Carla Guerrón-Montero*



# Registro de incidentes con Pueblos Indígenas en Aislamiento en el Territorio Waorani y Parque Nacional Yasuni

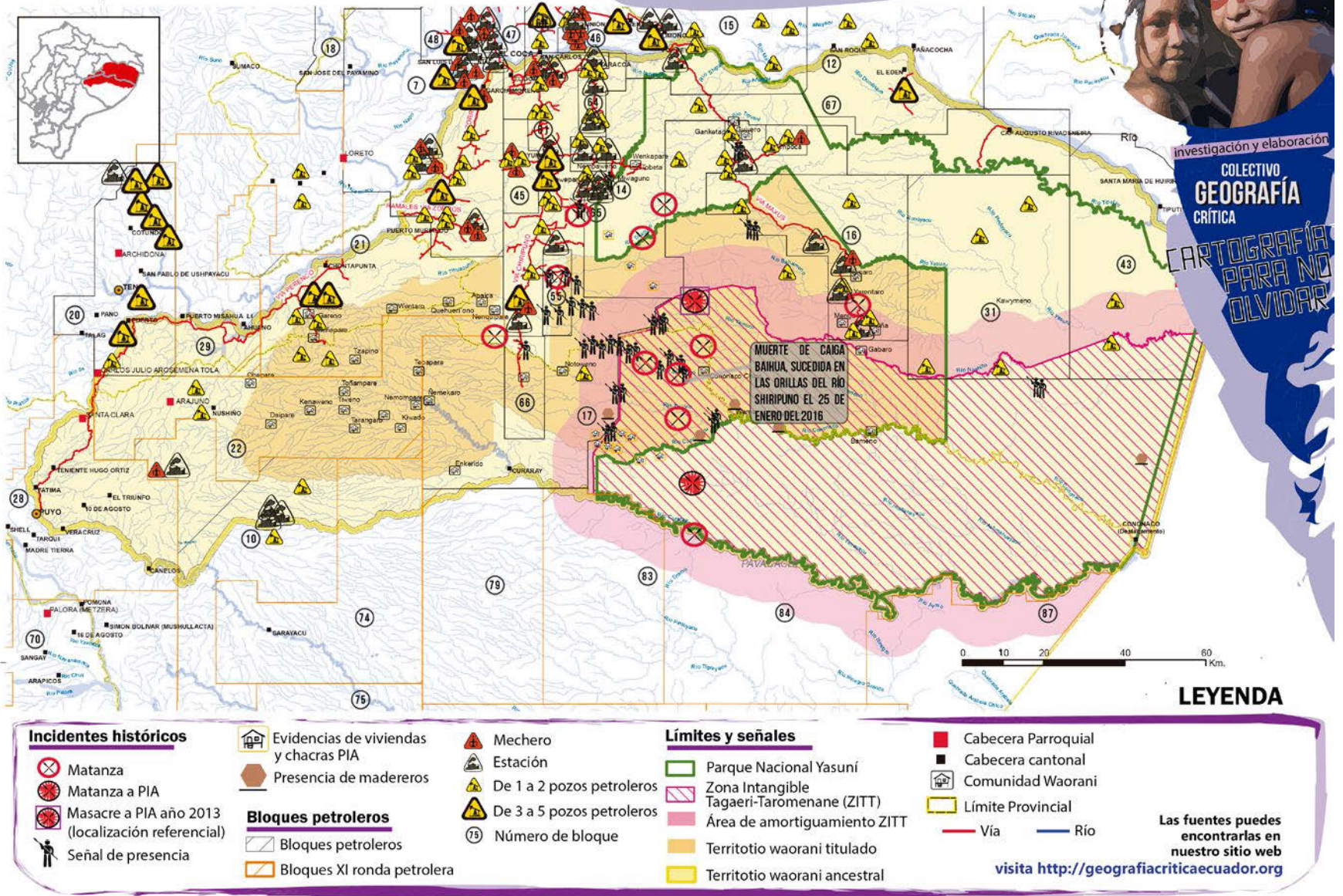

## Endnotes

1. The Montecristi Constitution recognizes the state as plurinational and intercultural, in addition to presenting an extensive list of collective rights and to considering nature as a subject with rights.
2. The article "Critical territorial knots in Ecuador: dynamics, changes and limits in the territorial reconfiguration of the state" (Bonilla et al., 2016) was the first effort to systematize the Collective's research. It presents an analysis of the challenges and limits of executing territorial rights in Ecuador. Another article that systematizes part of the research conducted by the Collective is titled "Geographies of sacrifice and geographies of hope: territorial tensions in plurinational Ecuador" (Silveira et al., 2017).
3. The case selection was based on a the following variables: national relevance, representation, degree of threat to a community, degree of invisibility and relevance, and the linkages and relationships we had developed with some communities and local resistance processes.
4. We analyze one specific case more in depth in the Manifesto against the Exploitation of the Yasuni National Park, published in [geografiacriticaecuador.org/2014/04/11/colectivo-en-defensa-del-yasuni/](http://geografiacriticaecuador.org/2014/04/11/colectivo-en-defensa-del-yasuni/)
5. The map is part of the "Preliminary Report about the State's Strategies of Social Control and Repression in the Context of the National Strike in Ecuador", prepared by the Psychosocial Research and Action Collective.
6. In the preliminary analysis for the Atlas, we defined three types of repressive action that the state has taken in order to facilitate investments and the territorialization of companies: administrative actions, covert actions and direct violence. The majority of cases are connected with administrative actions.

## References

Bonilla, O., Maldonado, P., Silveira, M. & Bayón, M. 2016. Nudos Territoriales Críticos en Ecuador: Dinámicas, Cambios y Límites en la Reconfiguración Territorial del Estado. *GeoGraphos. Revista Digital para Estudiantes de Geografía y Ciencias Sociales*, 7: 66-103 [hdl.handle.net/10045/53465](http://hdl.handle.net/10045/53465), 22 March 2018.

Silveira, M.M., Moreano, M., Romero, N., Murillo, D., Ruales, G. & Torres, N. 2017. Geographies of Sacrifice and Geographies of Hope: Territorial Tensions in the Plurinational Ecuador. *Journal of Latin American Geography*, 16(1): 69-92.

## Illustrations

Photograph previous spread left: Mapping of the ancient territory superimposed by the national park Llanganates, November 2012

Photograph previous spread right: GPS Workshop in the moorlands of Salcedo, April 2013



On August 16 2015, by executive decree President Rafael Correa declared a nationwide state of exception due to the increase in activity of the Cotopaxi volcano in the central Andes. Decree 755 gave extraordinary powers like the use of all members of the armed forces and police, use of public funds, suspension “of the inviolable constitutional rights of the home, transit, assembly, and correspondence” and censure of the media exclusively in the context of the eruption of the Cotopaxi Volcano. However, in both the indigenous Kichwa territory of the Saraguro in Loja Province in the south as well as in Puyo, in Pastaza Province, both far from the area affected by the volcano, the police and the military have used this decree to raid homes without court order, even for people who have not participated in demonstrations, in order to arrest and attack occupants in their homes, as in the case of Saraguro.

## SYMBOLOLOGY

-  Arrests of women
-  Arrests of men
-  Road block
-  Road block and demonstrations
-  Militarization of roads
-  Provincial Boundaries
-  Route of the march
-  Provincial capital

 DEPARTURE AUGUST

 ARRIVAL AUGUST 13

0 25 50 100 150 km



# COLOMBIA

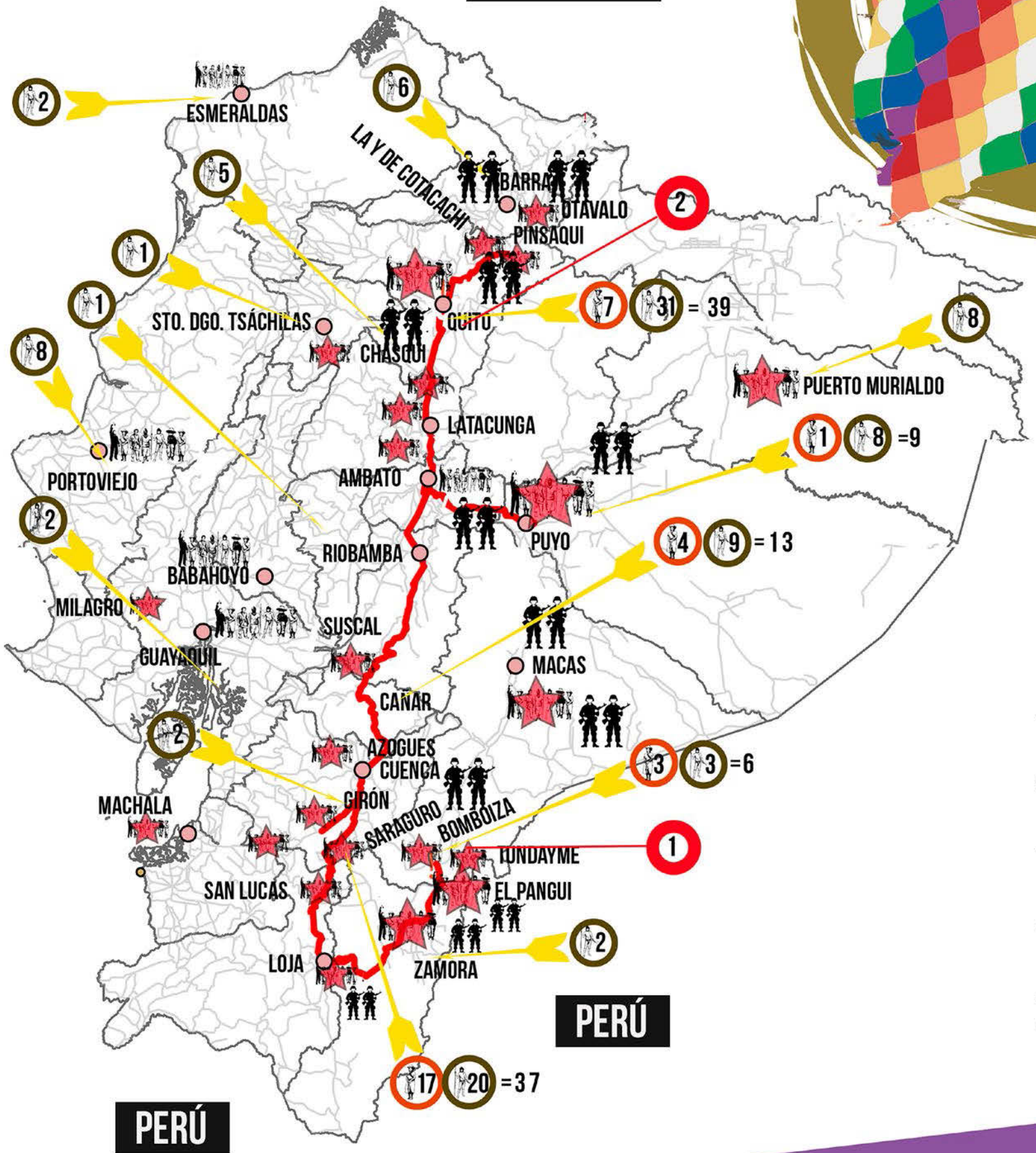
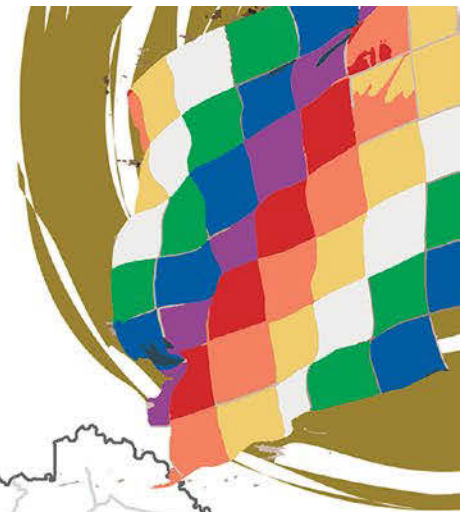

more information at <http://conaeie.org>

investigation and realization

COLECTIVO

**GEOGRAFÍA**  
CRÍTICA

CARTOGRAPHY  
WILL NOT  
FORGET

**ECUADOR**  
**Arrests and Military presence**  
the 18th to the 24th of August

# A Students' Map for a Students' Building

Working from within and beyond the Map

Geoide en Revolución  
[geoide-enrevolucion.blogspot.com](http://geoide-enrevolucion.blogspot.com)



We are Geoide en Revolución, a political group composed of students and alumni of the Faculty of Geography at the University of Buenos Aires. At some point in our activism, a few years ago, we began to understand and use social cartography (similar to participatory mapping) as a valuable tool for working with and for social organizations. Social cartography as a method is not offered within our college training, so we had to educate ourselves on our own. We started out through internal reading groups, participated in summits on the topic and soon put the tool to use. We have held workshops in secondary schools for adults, where some of our members teach, and in the villa (slum) n° 21/24, where we have been involved in the "Mesa Por la Urbanización Participativa de Villa 21/24" (the task group for participatory slum development).

While following this path, we decided to act on a territory which is key for Geoide: our school within the university, the Facultad de Filosofía y Letras (School of Philosophy and Literature). In November 2011 we organized a workshop aimed at mapping our school from the students' points of view, based on our knowledges as subjects who participate in creating this space every day. Our proposal and our challenge was to think about the school environment not only as a physical space but also as a socially constructed space which is disputed by different actors: students, authorities, teachers and other staff, each of whom possesses their own interests and political stances.

At the time the workshop was organized, there was a conflict – which still has not been solved – among school authorities, students and other actors concerning the construction of a new building. Many blueprints for this construction were presented by different architectural firms, but none of the buildings reflected student interests. Considering the current shortage and overcrowding of classrooms, the student body requests a building with large classrooms for undergraduate courses. We have also asked for a cafeteria with affordable meal prices as well as a nursery for the children of students and staff, both of which would facilitate the access of lower-income students to higher education. Neither of these have been included in the blueprints. The final blueprints for the new building include only classrooms, most of them small, which might be set aside for paid graduate programs or private language lessons (whereas undergraduate courses are free). On the other hand, the funds for construction will come from a company that is associated with transportation infrastructure mega-projects throughout all of Latin America – a fact which has caused alarm among students.



Our project started with a workshop in which we explained the potential of social cartography and then divided the participants into small groups for debating, exchanging ideas and drawing maps on blank posters. Some of the key questions we suggested were: What different spaces can we find in our school? What kind of actors, processes and problems do we associate with each one? What spaces do we feel closest to? Which spaces do we perceive as strange and unknown?

In this workshop, more than 50 students showed up from different majors (geography, history, anthropology, education and art history). Together we decided to merge the ideas that came up in the small groups into a single map, with the aim of showcasing both our work and the issues we wanted to make known and intervene with. We also particularly intended to systematize the discussion taking place during the activity. The workshop consisted of making maps but it went beyond that: How could we give an account of the concerns that came up during the process, exceeding the possibilities of expression on the map? Systematization, as an exercise of putting the collective production of knowledge into words, became a key tool in the project. After many meetings, in which we read and analyzed the maps, we put together a single map – presented here – that is intended to summarize our discussions.

The map displays the building's five floors as concentric circles. The lower floors (represented by the larger outer circles) happen to include the busiest and most democratic spaces, such as the courtyard, the student-run cafeteria and classrooms for entry-level courses. The upper floors are increasingly "elitist": The second and third floors contain more advanced courses and administrative offices, whereas research departments and other offices are located on the fourth and fifth floors (which are unknown to most students). The shrinking circles provide a visual analogy for the fact that many students start to study at university, fewer of them manage to continue and graduate, and even fewer can access research positions.

This map condenses the ideas, visions and representations which appeared in most of the initial maps, among which there were differences but also surprising similarities. Through different icons, it displays concerns and claims which are central to the student movement at our school and in our country. Examples include the disconnection between spaces of learning (classrooms) and spaces of research (in the case of our school the fourth floor, which is represented by question marks on the map); the commodification of knowledge; the need to democratize university decision-making processes; and the rejection of the school authorities' control of public spaces (security cameras, fences, private security guards, regulations on courtyard usage, limitations on poster-hanging and political activity in the hallways).

Additionally, the map expresses infrastructure problems which have worsened over time: insufficient classroom sizes, malfunctioning bathrooms, locked emergency exits, flooding that destroyed part of the library and power outages. Besides these issues, the map shows spaces which are connected to student activism. These places convey great symbolic meaning. Their very names honor the memory of young activists murdered during protests, such as Darío Kosteki, Maximiliano Santillán and Mariano Ferrera. Finally, the map mentions the historic moment in 2010 when students took over the school in protest: for 31 days normal activities were interrupted and public lectures as well as mass meetings were held.

This "map made by students" has been useful in several ways: When it was made, it condensed – in a single collective production – all student claims with regards to the new building, thus contributing to the student movement. The conflict concerning the building has continued through institutional channels, in a commission initially composed of teachers, students and staff representatives, facing many bureaucratic obstacles. For that reason the student body has ceased to participate and school authorities have gone ahead with their original blueprints (which have been described above) for a new building located next to the old one. The confirmation of construction has been considered a partial victory – since an imperfect new building is better than no new building at all – but as of 2016 it has not yet begun.

Our social cartography workshop has achieved its goal of making this tool more widely known and of solidifying our specificity as geographers and activists for a critical geography. At the same time we have positioned ourselves as part of a much larger collective: the student body of our school. We also had the chance to share this instrument with schoolmates who had not been aware of it and who now use it in their activist work as a tool for visualizing, constructing and transforming their territories.

# TALLER DE CARTOGRAFIA SOCIAL

VIERNES 11 DE NOVIEMBRE

HALL DEL 3° PISO

18 Hs.

## ENFILO

LA CARTOGRAFIA SOCIAL ES UN HERRAMIENTA QUE PERMITE HACER VISIBLES LOS DIVERSOS CONFLICTOS QUE SE ENCUBREN BAJO DIFERENTES PRÁCTICAS HEGEMÓNICAS, BUSCANDO GENERAR UNA TRANSFORMACIÓN SOCIAL A PARTIR DE LA CONSTRUCCIÓN COLECTIVA DE NUEVO CONOCIMIENTO.

USUALMENTE LOS MAPAS SE NOS PRESENTAN COMO REPRESENTACIONES INCUESTIONABLES DEL MUNDO REAL, PERO OCULTANDO DISTINTAS DESIGUALDADES Y CONFLICTOS SOCIALES. DE HECHO, EL MUNDO ES UNA REALIDAD PERCIBIDA Y CONSTRUIDA COLECTIVA Y HETEROGÉNEAMENTE. DECONSTRUIR LA IDEA DEL MAPA COMO ALGO DADO ES APROPIARSE LA HERRAMIENTA PARA DISPUTAR PODER.

Construyamos entre todxs un mapa de nuestra Facultad para conocer los conflictos que nos atraviesan y generar cambios de manera conjunta!



### Workshop of Social Cartography in the Faculty of Philosophy and Language

While searching for social transformation, which is based on the collective construction of new knowledge, social cartography is a tool that allows to show the different conflicts hiding behind a variety of hegemonic practices.

Although they omit various inequalities and social conflicts, maps are often used as unquestionable representations of the real world. At the same time the world is constructed from multiple perceived realities and thus collectively and heterogeneously built. Deconstructing the idea of the map as something widely accepted means to appropriate the tool in order to dispute the relations of power.

Let's get together and build a map of our faculty in order to learn more about the conflicts around us and to facilitate change collectively!

# REFERENCIAS



Puesteros

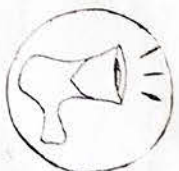

Consignas y reclamos estudiantiles



Espacios en lucha

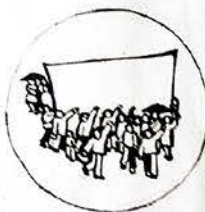

Espacios de los estudiantes

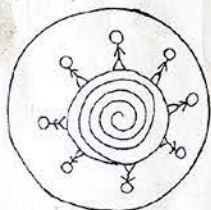

Construcción colectiva de conocimiento

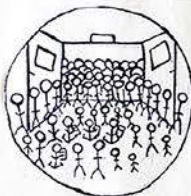

Asinamiento

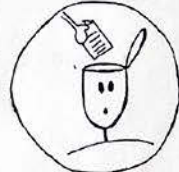

Reproducción de conocimiento

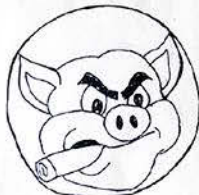

La gestión



Patovas de la gestión

Emoción de la gestión

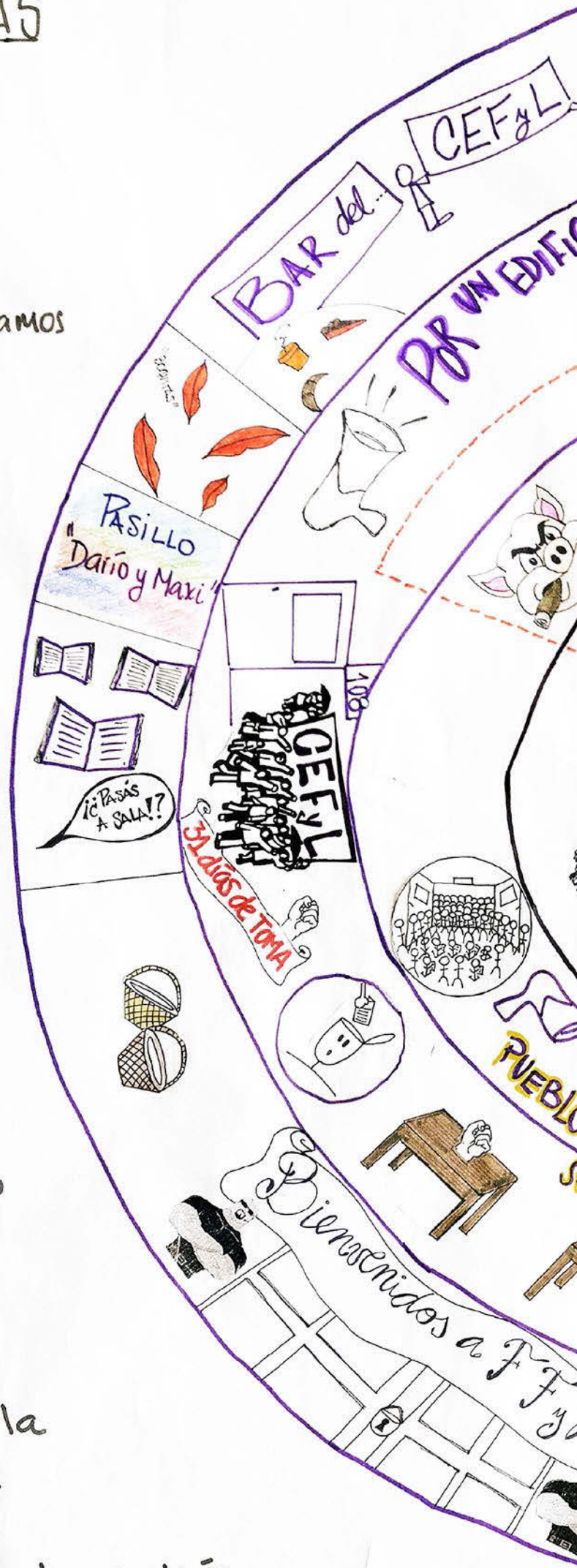

TRINCHERO, CARETA, VENITE en BICICLETA!

EL UMBRAL

ACÁ DEBERÍA HABER UN EDIFICIO!!!

EDIFICIO INTEGRADO CON AULAS de GRADO, COMEDOR y GUARDE RAYAN

NO ACREDITAMOS Ni ACREDITAREMOS!!!



LA EDUCACION del NO SE VENDE DE FIENDE

FUERA PATOVAS de FILO!

Planta baja y subsuelo

Aula "Mariano Ferrer" COMISIONER del CEFIL

Si el edificio me está... que quilombo que se va a armar

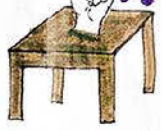
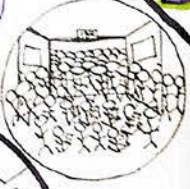
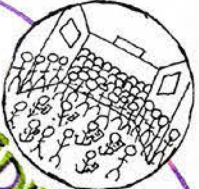
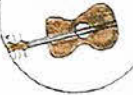

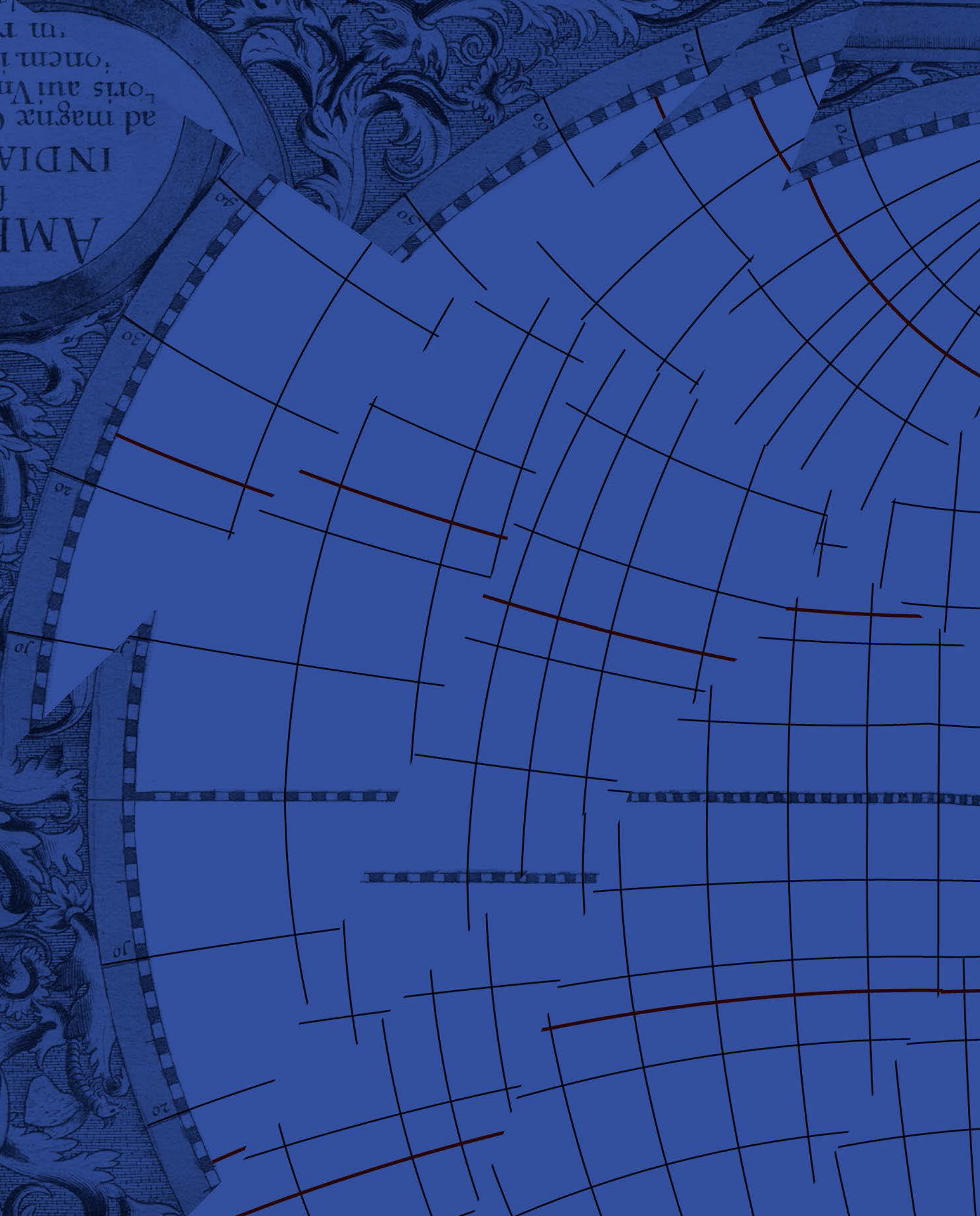

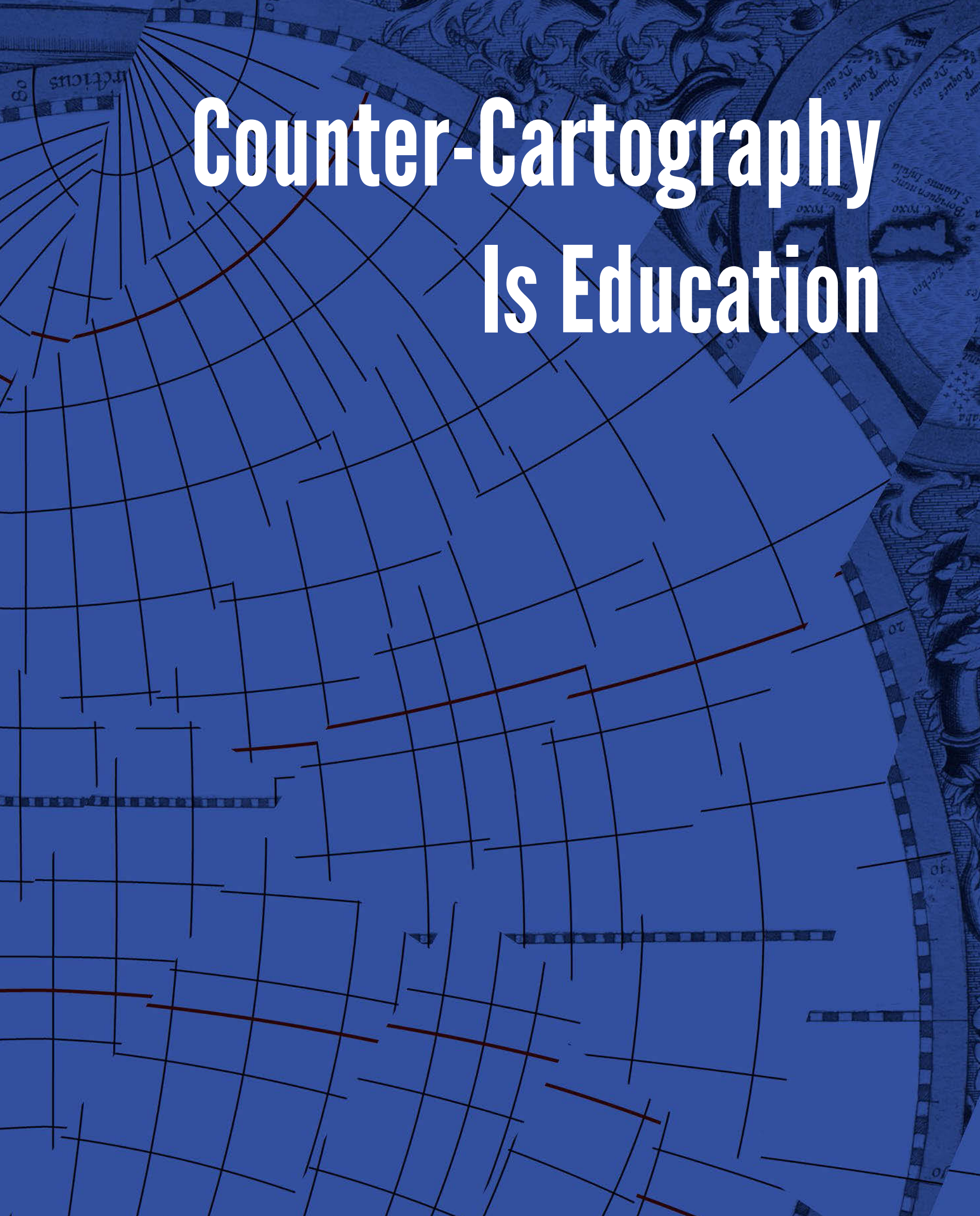

The background is a blue-tinted image of a historical map. It features a grid of latitude and longitude lines. Several lines are highlighted in a darker red color. The map includes decorative elements like scrollwork and text in Latin, such as "Rogues De qua", "Borduen hunc", and "C. Machro".

# Counter-Cartography Is Education

# Counter-Mapping for Resistance and Solidarity in the Philippines

Between Art, Pedagogy and Community

Arnisson Andre C. Ortega, Ma. Simeona M. Martinez, Cian Dayrit, Kristian Karlo C. Saguin



Mapping is a deeply political practice. Especially when considering how it is embedded in the reproduction of power in the Philippine context. Historically, mapping can be linked to colonial exploits and imperial pursuits as it attempts to represent colonized populations and places within a legible territory conducive for exploitation and control (see Harris & Hazen, 2006). In the Philippines maps serve as nation-building tools as they project a spatial vision of a nation that can easily be managed, planned and subjected to militarization. Maps have been largely used as tools for accumulation and control by the state, the industries, the church and other powerful institutions while the interests and needs of subaltern populations were ignored. Opposing these mapping practices, we argue that mapping can be reclaimed and used for social justice. In this contribution we feature collaborative counter-mapping efforts by critical Filipino geographers, artists and communities in the Philippines. With progressive goals, these counter-mapping projects grapple with how to articulate space not just to appropriately represent the everyday geographies inhabited by marginalized populations. They also provide mechanisms to criticize neoliberal projects, to build stronger alliances among groups and to expose the malevolent geographies of accumulation and dispossession which are behind the contemporary developments in the Philippines. Further, these projects reflect the multiplicity of counter-cartographic initiatives that often entail engagements across various sectors, from university students to people's organizations.

### **The Context: Development, Nation and the Need for Counter-Mapping**

Development is a highly contested term that is associated with multiple meanings and the visions of various groups. For the state, development is a necessary outcome it has to provide for its population. Its articulation through actual programs usually entails the identification of spaces that policy interventions and development visions are projected onto. In development, maps and mapmaking serve as an important role in making state spaces legible. In recent decades the Philippines have been subject to investment-oriented policies and programs, which in turn have encouraged the conversion of the use of land and the creation of special economic zones (SEZs) to attract foreign capital (see Ortega, 2016; Kelly, 2000). Across the country, vast tracts of land have been identified and planned as sites of SEZs (see Ortega, Aciego & Hermida, 2015). These projects are contained in master plans that carry the state's vision for these spaces and are rendered powerful as they tend to override other visions and claims made by residents. Those who live in these spaces do not necessarily have the same spatial vision as the ones projected by the state in master plans.

Counter-mapping brings together these multiple visions of space. As an antidote to the fixed and final partitioning of space by the state, counter-mapping sees maps as processes and encounters that recognize multiple spatialities operating simultaneously. By counter-mapping national spaces of development, we therefore expose the contested visions of development. We consider participatory methods and art as creative and effective means for counter-mapping that challenge the state's spatial vision.

### **Counter-Mapping, Art and Pedagogy**

Many counter-mapping projects have been associated with creating community maps to be used for indigenous claims. There are, however, multiple forms of counter-maps and counter-mapping practices that contest state power. In this chapter we focus on how art and pedagogy can be potent ways of engaging and collaborating with communities by using maps.

Art provides a creative medium for communicating aspirations, dreams and the plight of marginalized populations. Through collaborative and community-oriented art projects, spatial narratives of the oppressed may resist and outlast hegemonic stories about specific landscapes and built environments. These projects may rupture rigid cartographic narratives of city projects and regional master plans by exposing contested histories, relations and bodily experiences that have been silenced for the sake of particular notions of progress and development.

Counter-mapping can be an effective pedagogical tool for both students and communities. Through the processes from formulating problems and collecting data to creating and disseminating maps, counter-mapping exposes critical issues faced by marginalized communities as well as the ways in which cartographic concepts and tools can be applied when addressing these concerns. Furthermore, counter-mapping also activates the political possibilities of solidarity by connecting the struggles of marginalized communities with pedagogical objectives.

### **Counter-Mapping through Art**

The Filipino artist Cian Dayrit uses cartography and mapping to tackle power, control and memory. His compelling body of work incorporates imagery, context and cartography in an effort to creatively visualize information, particularly that involving social and political movements. In his work mapping is considered a tool for resisting hegemony, for projecting the aspirations of marginalized classes and for exposing issues of dispossession among the landless.

Given that maps serve as an emblem of imperial imagination, Cian uses cartographic images to expose neo-colonial visual unconsciousness and subvert Western cartographic practices. For example, his Atlas of the Global South exhibition investigated geo-political tensions, neo-liberal policy and neo-colonialism that have shaped Global south affairs. The maps in the project challenge the traditional format of historical maps in order to plot and represent issues of inequality, hegemony and violence. In Cartography for Colonialism, Cian proposes alternative readings of colonially-defined borders. It attempts to defeat the function of maps as tools to uphold the traditional structures of political power while creating counter-narratives of the reconstruction of colonial property history. Questioning the validity of Western cartographic practices and its authorship, this project interrogates the notions of nationhood and imperialism and takes on the angle of history from "below". This is done by using pre-colonial place names, plotting places of power and resistance, and tracing social and revolutionary movements as well as trade routes, demarcation lines and piracy (see map at the end of the article, left). Another exhibition titled Seascapes: Tranquility and Agitation features map pieces that question notions of nation building and sovereignty as well as territory and struggle (see map at the end of the article, right). A map of Negros Island, which is known as the sugar bowl of the Philippines, presents multiple views

on the history of the island and the sugar industry. On the one hand, it shows the family tree of Jorge Vargas (executive secretary to President Manuel L. Quezon in Commonwealth Philippines, donor of Vargas Museum, among many other things). It shows a marker for his birth place as well as the names of the prominent families who migrated to the island in the 1880s to invest in sugar production. On the other hand, the map focuses on feudalism and struggle in the sugar industry. In the main cartouche, the pre-colonial place name for the island was used to symbolize the resistance against colonial oppression and the feudal state.

Cian's art also involves collaborations with collectives, unions, academics and other individuals. This practice is largely borne out of the need to articulate issues concerning social justice and inequality, particularly with peasant and indigenous communities. These collaborations underscore the need to explore alternative modes of resistance to the neo-colonial, semi-feudal state system which rampantly exploits the marginalized sectors of Philippine society. He has forged alliances with various groups in conducting community-based indigenous mapping and counter-cartographies, melding ethnography, mapping and art. An example of these collaborations is a series of workshops with indigenous peoples and farmers held in protest spaces and encampments in Metro Manila. These workshops involved asking participants to draw maps of their everyday lives in their home communities. The aim was to develop a counter-mapping module that can be used in community organizing and in making maps for showing spaces of displacement and dispossession. Through memory work, participants made mental maps (see illustration below) that identified the sites where they lived, worked, worshipped and organized. The maps also situated places of fear and confrontations, especially sites in which harassments by (para)military forces occurred. Participants used various ways of representing their tumultuous community geographies, such as labels, icons, lines as well as elaborate narratives explaining certain sites and relationships. Identified spaces included sites of horrific events, such as massacres, areal bombings by the military, ambush sites, polluted rivers caused by refineries, old trails that had been fenced off by developers, mining and logging sites and monocrop plantations of

multinational corporations. After drawing their maps, all participants took turns in showing their maps and fortifying their work with stories of their experiences in their communities. The workshop illustrates how cartographic representation of displacement and other abuses can be supplemented by narratives.

### Counter-Mapping through Pedagogy

Another series of counter-mapping activities involved university students and professors who engage in solidarity work with indigenous peoples and farmers. At the University of the Philippines (UP), critical cartography and counter-cartographies are conducted as participatory action projects. Being selectively integrated into the content of several courses, they also contribute to enriching the activities of student organizations.

Since 2010, the Junior Philippine Geographic Society of UP Diliman has been conducting a counter-mapping project called Contour: Mapping for the People. With the aim of highlighting the plight of marginalized communities impacted by development, the project uses a participatory mixed-use mapping approach that combines GIS techniques with qualitative methods. Over the years, Contour has used counter-mapping to engage with urban and rural communities, such as San Roque, an urban poor community in Quezon City. The main aims were fighting against informal settler demolition as well as the construction of new urban business districts. Another community was Hacienda Luisita, a contested agricultural land in Central Luzon where farmers are fighting for their right to collectivize and plant crops.

In the UP Department of Geography, undergraduate students of the second semester of 2012-2013 launched a blog titled Cartography Mission: Mapping with a Cause, a mapping project that caters to the needs of communities for organizing and visualizing spatial data in support of human rights advocacies. Along with a geography graduate class, students took part in a participatory 3-dimensional mapping (P3DM) of the ancestral domain of the Agta-Dumagat-Remontado<sup>1</sup>, an indigenous group from the Quezon Province at the southern foothills of the Sierra Madre mountain range. The activity was organized by NGOs that assist indigenous peoples in the process of ancestral domain claim-making<sup>2</sup>, the Non-Timber Forest Product Exchange Programme for South and Southeast Asia (NTFP) and Anthropology Watch (AnthroWatch). The students provided assistance to the Agta-Dumagat-Remontados primarily by preparing the materials that formed the base model for the 3-dimensional map (see photograph on previous spread). Aside from observing and documenting the P3DM process, students helped the elders and also conducted interviews with them and other participants like women and children. The goal was to obtain a better understanding of their situation as a marginalized group, and to elicit opinions on how the mapping activity could contribute to addressing their concerns and what they thought about the mapping activity in general. While they were conducting these interviews, the graduate students, who also participated in the field activity, travelled to the Sentrong Paaralan ng mga Agta (SPA), an elementary school the Agta has established in the municipality of General Nakar. Equipped with GPS receivers, they carried out an adhoc task of helping teachers and elders to locate the boundary monuments that delimit the perimeter of the school. The geolocated photos of the spots where the property markers were located were then over-

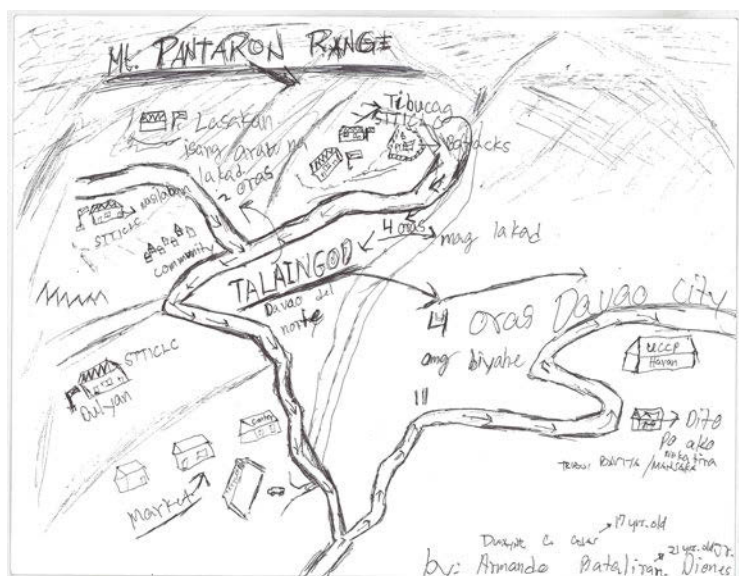

# MGA ISYU SA SITIO BUNTOG, CANLUBANG

Isang malaking isyu sa Canlubang, Lungsod ng Calamba, Laguna ang alitan sa pagitan ng pamilya Yulo at ng mga dati nilang manggagawa. Sa pagbabago ng paggamit ng lupa mula agrikultura patungong industriyal, unti-unting nilalamon ng pag-unlad ang Sitio Buntog sa pamamagitan ng pagtatayo ng mga gusaling pang-komersyal sa paligid nito.

Ang kalagayan ng mga mamamayan sa Sitio Buntog, Canlubang, Lungsod ng Calamba sa Laguna ay pinag-aralan ng isang grupo ng mga mananaliksik mula sa Unibersidad ng Pilipinas. Layunin nilang suriin ang nasabing pamayanan at makabuo ng isang mapa upang maging mabilis ang pagpaparating ng impormasyon sa mga mamamayan.



1 Isang paraan ng paglilimita sa pagkilos ng mga mamamayan sa loob ng sitio ay ang pagtanging mapaunlad ang mga kalsada tulad ng nasa larawan.



LARAWAN MULA SA GOOGLE EARTH



4 Isa sa mga panggigipit na dinaranas ng mga mamamayan ng Sitio Buntog ay ang pagbabawal ng pagpasok ng mga kagamitan katulad ng mga yero at tabla. Bunga nito, mga mabubuway na kabahayan lamang ang nalipundar ng mga mamamayan.



2 Isa sa mga paghihirap na dinadanas ng mga naninirahan sa Sitio Buntog ay ang kakulangan sa suplay ng tubig at kuryente. Ang pinagkukunan ng kanilang tubig ay mula lamang sa ilog na malapit sa sitio at ito'y nagdudulot ng malaking abala sa mga tao lalo na sa mga matatanda. Ang kuryente ay ipinagkaloob noong 1990s ngunit ng tumumba ang poste noong 2010, hindi na ito naayos at ipinagbawal ang pagkabit ng kuryente dahil dadaan ang kable sa isang pribadong lupa.

Ang mga impormasyong matatagpuan dito ay mula sa mga nainterbyung mamamayan sa Sitio Buntog.

Mariing tinututulan ng panginoong lupa ang pagsasaka ng palay at pagluwas ng produktong agrikultural. Madalas, ipinupuslit ang mga ito sa pamamagitan ng pagbabagtas ng mga peligrong daanan malapit sa ilog kung saan walang nagmamatyag na mga security guard o di kaya'y pagdurugtong ng kable sa magkabilang panig ng ilog upang mailuwas ang naaning produkto.



3

Sabrina Apolinario | Niel Anne Espiritu | Socrates Mariano | Herbert James Taniza  
Geography 197 | 1st Semester A.Y. 2013-2014

lain on Google Earth with annotations, printed, and provided to the elders a few months after the field visit.

Cartography Mission was conceptualized as a blog for student projects that put emphasis on the map as a communication tool. The project asserted the need to look beyond cartography as an academic exercise for the production of maps. While the field visit was brief and interaction with the community was limited, it had a significant impact on the students in that they realized that mapping can be a collective activity with the potential of revealing the realities of places for the marginalized sectors and help them share their situation.

Another project involved the creation of an online blog titled, Cartodiem (everyday cartography for everyone). Launched in the first semester of 2013-2014, Cartodiem sought to utilize mapping technologies, cartographic communication theories, map design principles and online media in order to bring maps and cartography to the forefront of information advocacy while promoting spatial knowledge. It featured the Canlubang Counter Mapping Study, which aimed to map the multiple spatial narratives of urban development in the former Canlubang Sugar Estate in the province of Laguna. In Cartodiem, students used spatial data collected from interviews and site visits for producing three maps that uncovered histories and lived realities of urban development:

1. An animated map that shows the development of the Canlubang estates. The team collected data from internet sources, brochures and the websites of real estate developers. The final map indicates the year that a particular development project or structure was established, a description of the structure, the type of use that it serves (e.g. institutional, commercial, etc.) and its size.
2. A poster map on which the narratives of farmers and residents of Sitio Buntog (a village in Barangay Canlubang) are geolocated and plotted on top of Google Earth imagery. The students listened to interviews which were recorded by JPGS members during field trips for a separate research project conducted by Dr. Ortega and noted the places that were mentioned by the interviewees, using Google Earth imagery (see illustration above).
3. A map that identifies the land use changes in Barangay Canlubang (see illustration on next spread). Pictures showing recent developments in selected portions of the barangay were added to the original content of the mentioned map.

In an article featured in the blog, two members of the class, Mr. Socrates Mariano and Ms. Niel Anne Espiritu, wrote about their experiences:

*"The class of Geography 197 feels honored to take part in this movement spearheaded by the people of Canlubang in their quest for recapturing their lost rights. We are greatly pleased to contribute our cartographic skills to the portrayal of the issues and other problems they face through creative, effective and constructive maps that aim to capture a clearer picture of their struggles. As maps traditionally serve as a powerful ingredient in the attainment of social change, we feel delighted that in some way we have realized one of our roles of being a geographer, 'mapping for a cause'."*

## Conclusion

The projects we featured in this chapter show how counter-mapping can be used in art and pedagogy. As exemplified by Cian Dayrit's work, art provides a medium to culturally resist hegemonic representations of space and thus criticize neo-colonial development. At the same time, counter-mapping through art has the ability to gather and re-articulate narratives of marginalized communities who struggle against violence and dispossession.

Counter-mapping initiatives such as the workshops held in protest spaces and the Canlubang counter-mapping project demonstrate how narratives of marginalized populations may be represented in multiple ways: from mental maps that were drawn from memory and depict the tumultuous everyday life of indigenous communities to poster maps that used geospatial technologies in combining administrative data sources with field accounts. Also, the projects not only show how counter-mapping provides the mechanisms to resist and criticize development or neo-colonial discourses but also how it can facilitate land claims of indigenous peoples. In particular, geography students collaborated with the Agta-Dumagat-Remontado group of the Quezon Province so as to save their ancestral land by assisting in the creation of a 3-dimensional model of their community.

These experiences show how cartography is more than a set of visual techniques for representing places. Moreover, the projects reveal that it is equally important to emphasize the role of social relations in the production of maps. In counter-mapping, solidarity and attainment of progressive goals serve as the main driving forces that interconnect students, teachers, activists and the community. However, a critical concern for these projects is their sustainability and scalability. Since these were mostly time-bound initiatives and constrained by the lack of resources, sustaining collaboration with communities has been challenging. Also, as issues confronting these communities evolve, updated maps need to be generated and communicated. Given these challenges, we argue for the need of sustainable counter-mapping projects that involve multiple sectors and institutions.

## Endnotes

1. The indigenous group is represented by the Samahan ng Katutubong Agta- Remontado Dumagat na Ipinaglalaman ang Lupang Ninuno (SA-GUIBIN-LN), a local Peoples' Organization (PO) from General Nakar, Quezon Province.
2. In the Philippines, indigenous peoples need to undergo the process of ancestral domain titling through self-delineation, as stipulated in the rules and regulations implementing the Indigenous Peoples Rights Act (IPRA) of 1997, to attain entitlement to their ancestral lands and waters. Part of this process is the submission of proof that includes historical accounts of agreements on boundaries and descriptions of traditional landmarks as well as surveys and sketch maps of the ancestral lands (The Indigenous Peoples' Rights Act, 1997). Several non-government and peoples' organizations engage with the government and indigenous groups to facilitate the consolidation of relevant documents with respect to the requirements provided by the law mentioned above.

## References

- Cooke, F.M. 2003. Maps and Counter-Maps: Globalised Imaginings and Local Realities of Sarawak's Plantation Agriculture. *Journal of Southeast Asian Studies*, 34(2): 265-284.
- Harris, L.M. & Hazen, H.D. 2005. Power of Maps: (Counter) Mapping for Conservation. *ACME: An International Journal for Critical Geographies*, 4(1): 99-130.
- Hodgson, D.L. & Schroeder, R.A. 2002. Dilemmas of Counter-Mapping Community Resources in Tanzania. *Development and Change*, 33(1): 79-100.
- Kelly, P.F. 2000. *Landscapes of Globalization: Human Geographies of Economic Change in the Philippines*. First edition. London ; New York: Routledge.
- Ortega, A.A. 2016. *Neoliberalizing Spaces in the Philippines: Suburbanization, Transnational Migration, and Dispossession*. Lanham, MD: Lexington Books.
- Ortega, A.A., Aciego, J.M.A.E. & Hermida, M.C.H. 2015. Mega-regions in the Philippines: Accounting for Special Economic Zones and Global-Local Dynamics. *Cities*, 48: 130-139.
- Parker, B. 2006. Constructing Community Through Maps? Power and Praxis in Community Mapping. *The Professional Geographer*, 58(4): 470-484.
- Republic of the Philippines. 1997. Republic Act No. 8371. The Indigenous Peoples' Rights Act of 1997. Manila, October 29. [officialgazette.gov.ph/1997/10/29/republic-act-no-8371/](http://officialgazette.gov.ph/1997/10/29/republic-act-no-8371/), 19 April 2018.

## Illustrations

Map on following spread left by Cian Dayrit: Objects of Colonial Desire 2017, oil and collage on canvas (Seascapes: Tranquility and Agitation, Metropolitan Museum)

Map on following spread right by Cian Dayrit: Mapa de la Isla de Buglas 2017, tapestry (Almost There, Vargas Museum)

Photo at the beginning of the article by A.Vitug.

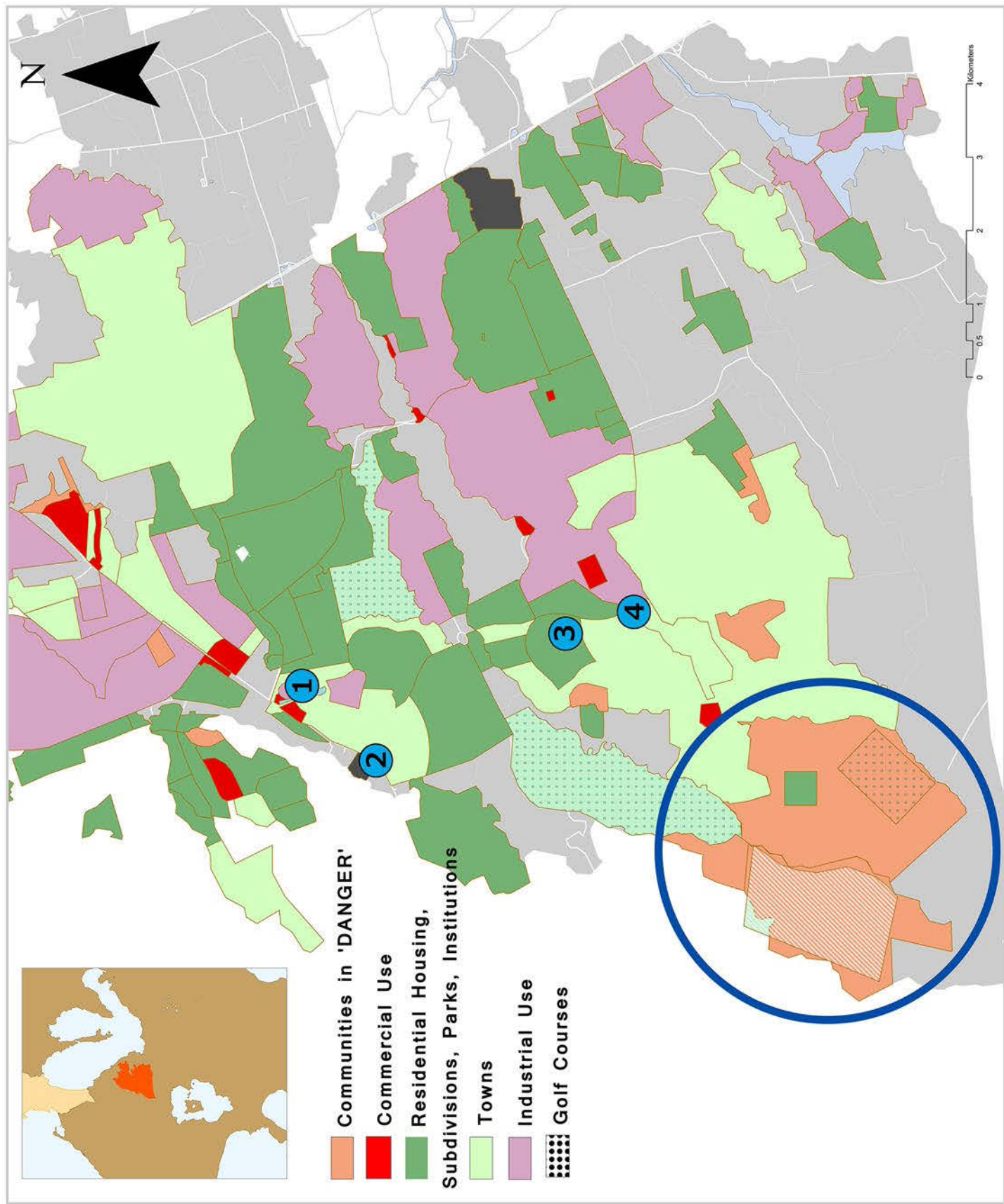

**SOURCES:**  
 Open StreetMap  
 Google Earth  
 Geofabrik  
 Images from Panoramio  
 Field interviews conducted by  
 Amisson Ortega Ph.D.

**AUTHORS:**  
 Amoroso, Dominique Sasha  
 Felonia, Jeric  
 Nepomuceno, Allayssa May  
 Verzosa, Christine Angelica

# Land Use Changes in the Yulo Estate Barangay Canlubang ( 2011 - 2013 )

**1**

Due to the direct impact of road productivity, demand of land for commercial purposes has increased in some parts of the barangay. The study area has seen some rapid changes and diversities from traditional system to modern system.

**2**

Back in the year 2008, this area was said to only contain a plain vast field of land. In only a span of 5 years, condominiums and other residential places were built by the Ayala land group of companies.

**3**

As urbanization speeds up, some parts of previously agricultural lands were converted into residential houses, which resulted in the exemption of these lands in the Comprehensive Land Reform Program (CARP)

**4**

The place has developed from a forested area to an urbanized community. Roads were constructed to provide accessibility to the establishments nearby.

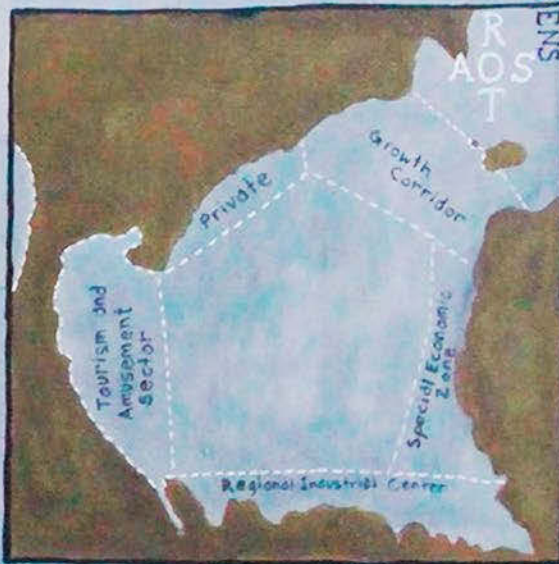





Hilaga 123°

20°

S O A R T



PUREZA



Saccharum officinarum

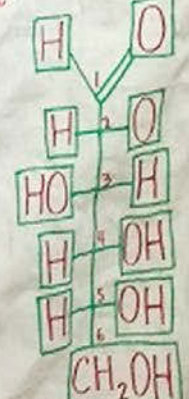

Domagete

O R P A E



Henricus Yndio Bicolano lo hizo

Silangan

Kanluran 120°

123° Timog

20°

# Mapping inside (and outside) the Classroom

Nicolás Frank, Fernanda García





This reportage shows a collective process of knowledge production concerning a rural borderline region of Northeastern Uruguay. Getting to know the past and the present, and trying to imagine the future, was the means to analyze its transformations. By involving teachers, children and neighbours from five public elementary schools of the region, along with university students and professors of the Universidad de la República – Udelar – (Uruguayan public and mayor university) from different parts of the country, we tried to re-construct the historical geography of the way of living in the area. For this purpose we applied a wide variety of techniques, such as social cartography, oral history, bibliographic review, field observations, interviews, photography, contributing to an educational interdisciplinary, inter-cultural, inter-institutional and inter-generational experiences.

Both activities described in this reportage took place in 2013. The first one was a meeting of the public schools network of the region called Agrupamiento Escolar Renacer. The second one was an encounter between 34<sup>th</sup> School and a group of Physical Education students. These small rural schools have only one teacher and 5 to 15 students of different ages.

One teaching goal of social science in elementary school is to prepare the students to live in society. For that purpose it becomes necessary to invite them to think about the reality we live in, and that this reality also has a spatial dimension. Being complex and always in motion are two main features of social reality. They make mapping – and cartography as a language of geography – a rich and versatile strategy. Maps were used in subsequent initiatives setting the basis of what we already knew and as "communication devices" with the help of which people of different origins, ages and experiences were able to interact.

### Mapping with the Children: Teaching Sequence

The sequence of activities that took place in 34<sup>th</sup> School started with the concept of "place" as a spatial category of analysis regarding its subjective dimension based on personal experiences and a sense of belonging. The students developed the maps of the area they live in individually and without the intervention of teachers.



These initial maps, which were as many as there were students in the school, reflected the perception of their immediate reality. Every map was the materialization of an individual's mental construction, which opened the way for further analysis about the author's personal opinion about the presented issues. In addition, as classes in rural schools are made up of children of various ages, differences in map construction according to the children's ages can be observed. On this basis, decisions were made and future interventions were planned. That is how a walk through the area was organized. Every child brought his or her own map, making it possible that all children could become aware of the relation between what they had originally drawn and what they could see for themselves. Some of them decided to modify their maps in order to share it with their classmates afterwards.

The next step was for the class to create a "group map". Every student's perception was included on this map, which enhanced the map and enriched every child's experience by interacting with his or her classmates. Even though it was a "non-scale" construction, some cartographic elements, such as color codes or references, were incorporated. These were identified by the children by analyzing other kinds of cartography usually found in the school's regular activities. They included maps with topographic or thematic information, Uruguayan political subdivisions, world atlases, and the like.

On the next level of analysis, satellite imagery was introduced, by working with computers and the open platform Google Earth. Other elements that had not been present in the previous maps were included. Forests and plantation were identified, distances between places were not what they had seemed to be, surfaces of dams also looked different. The satellite view generated changes in the way they perceived their own places. After printing the satellite images they were compared with the "group map", establishing differences and similarities between both spatial representations. The students identified places that were important to them – where they played and had fun, places they enjoyed with their families, paths and roads that were part of their daily routine, etc. Accordingly, some annotations and additional references were added to the printed image by hand.



In the end, the exercise – which was organized throughout the school, using similar methodologies – included a space where the groups could socialize and share their work with each other. By doing so, maps were the spatial basis from where reflection was promoted. By moving from the descriptions of the spaces to their explanation, from known facts to "thinking reality", new knowledge that has the potential of being applied to other situations and problems was gained. Working on a problem that involved all areas of school made it possible to recognize and appreciate multi-causal social phenomena and the discussion about actions, actors and intentions.

### Inter-Generational Dialogue with and through Maps

The first activity occurred during a meeting of the various school groups; it was organized to share thoughts and gather information on the relationship between pesticides and human health. This relationship was discussed in a project held by the school groups, the extension service of UdelaR and a group of neighbors from that area. At the beginning of the meeting, every school presented their maps. Afterwards the participants were provided with topographic base maps of their areas and had to locate, present and discuss different activities which took place there. According to the topic of the meeting, when mapping, special attention was paid to the interaction between locations of production and the watersheds of their areas. These maps provided a rich input for the meeting, as well as for subsequent activities.

One of the activities enriched by these items was the second one this reportage focuses on. It took place in 34<sup>th</sup> School in Cerro Largo, Uruguay, located in Puntas del Chuy, and it is one of the participants of the Agrupamiento Renacer. The school was visited by a group of students from the Superior Institute of Physical Education of UdelaR (mostly from Montevideo, the capital of Uruguay, which is 400 kilometers further south), who were studying the challenges and possibilities of physical education in rural areas along with the University's extension service. The school children presented the maps they had made about their area to the young physical education students. The students encouraged the children to think about the relationship between the education of the body



in the countryside and the city, the games, the physical activities and their environment. Together they analyzed the games, how the children exercised on a daily basis, and the locations where these physical activities took place. By taking a walk through the areas they were able to map and discuss the spatial relations, that had been established during other activities taking place in their territory. An example of this is the relationship between the creek where the children usually play and fish, and the new intensive agriculture that is taking place in its watershed. This agriculture includes the use of high amounts of pesticides and herbicides, which can be harmful to their health. Mapping these spatial configurations isn't enough to establish causal relations about health or environmental problems, but it enriches the collective process of asking new questions.

### Epilogue

These experiences show us that maps and the process of mapping together are powerful communication tools. The combination of a variety of elements, such as colors, shapes, textures, text and numbers, provides different ways of comprehension and contribution at the same time. This is very important when working with students of various age groups or with adults from different social contexts. They have not always fully developed their writing/reading skills but nevertheless they have a lot to say about their territories. This way an important diversity of knowledge (academic/non-academic; local/foreign; adult/young child/elder) can be a part of the spatial analysis and the gathering of large amounts of information. The process of making maps on paper and/or other materializations also makes it possible for them to be read and analyzed afterwards, promoting discussions held at different times and places. Maps help to build a "common language" necessary for communication as well as for the overcoming of cultural, territorial and generational boundaries.

#### Illustrations

All photographs by Jimena Quintero, Walter Oreggioni & Nicolás Frank - PyCA-Project.

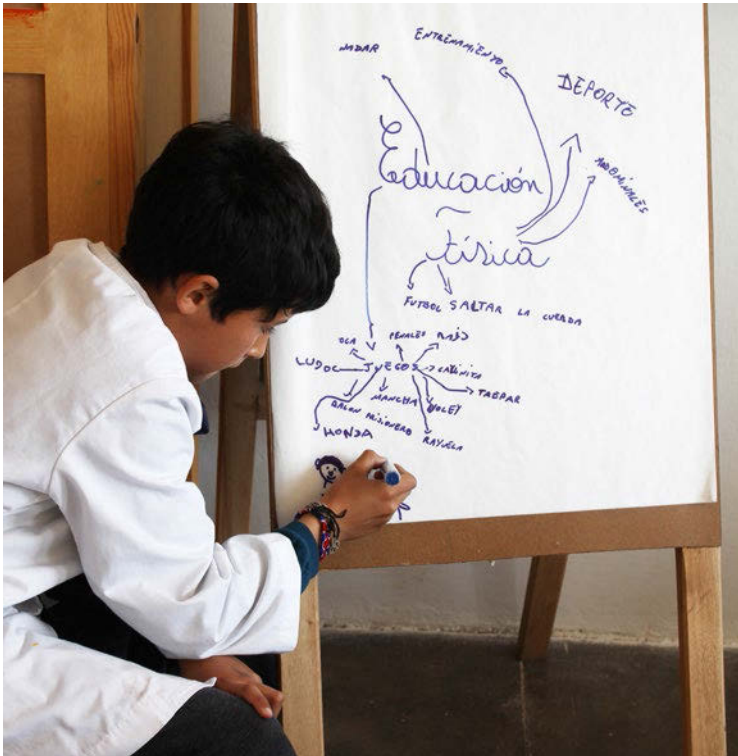



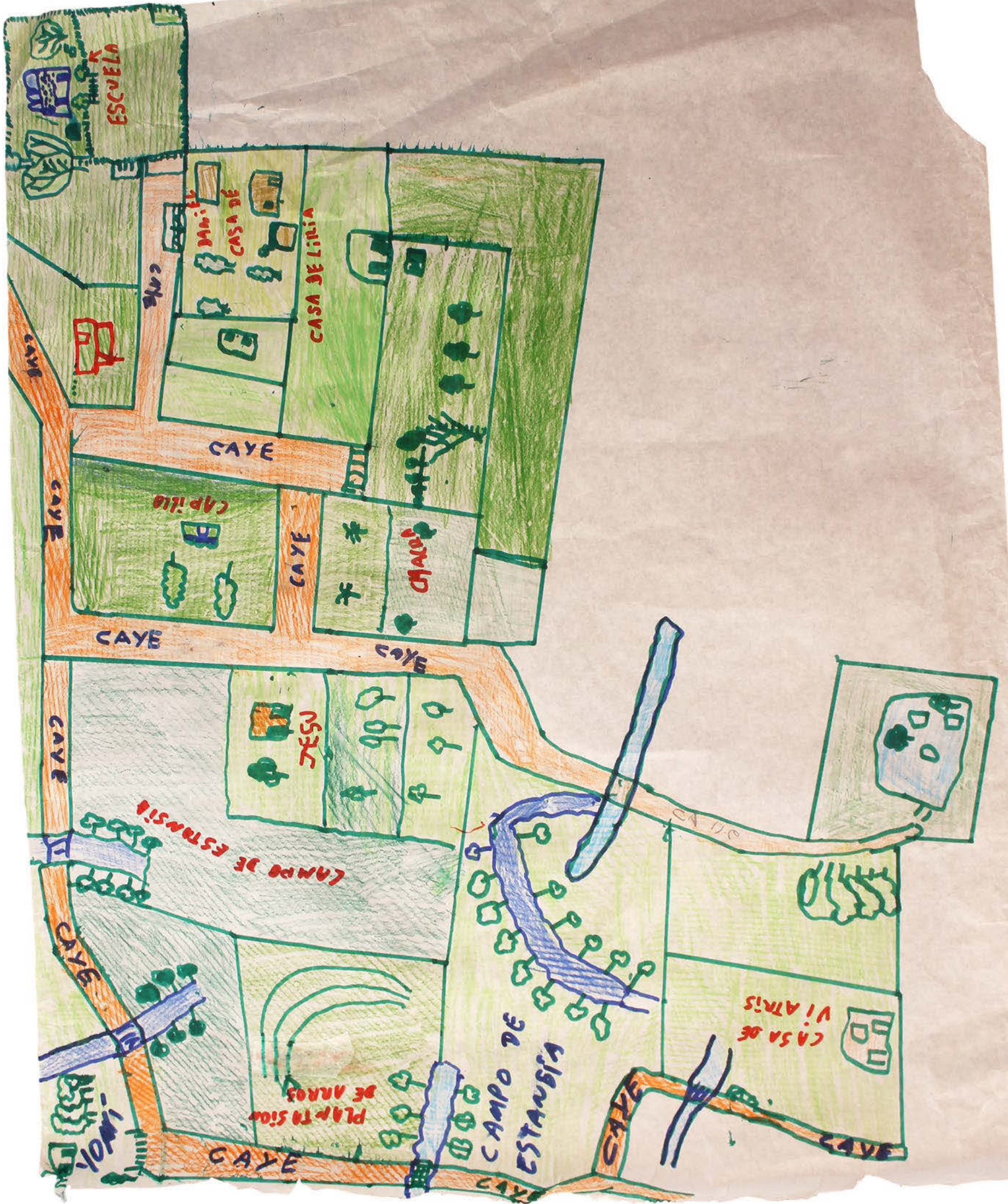

ESCUELA

CASA DE DANIEL

CASA DE LIRIA

CAYE

CAPILLA

CAYE

CAYE

CAYE

CAYE

JESU

CAMPO DE ESTANBIA

CAYE

CAYE

PLANTACION DE ARBOS

CAMPO DE ESTANBIA

CASA DE VIAJEROS

CAYE

CAYE

CAYE

# Protest Map, Cartoon and Propaganda'

## The Hidden Object Map Right to the City

Marc Amann, Markus Wende

marcamann.net

animationsfilm.de





The city from above. Birds-eye view. Comic style. Streets, buildings, places, gardens, 2000 characters. One big scene comprised of many small places and situations. A construction site of an expensive large-scale project, a gated community, a biotech laboratory. Protest actions against rising rents and displacement, for feminism, against capitalism. Alternative economies, a community-supported vegetable plantation, housing projects, a factory occupation, an anti-racist protest camp. Struggles for the commons and a good life for everyone.

The image is an invitation for rediscovering and recognizing, for smiling and smirking, for questioning. It is a little bit of propaganda and a little bit of cartoon. It is chaotic and dynamic. For children and adults.

In the last few years the hidden object format has experienced a revival and uncountable hidden object maps, books in different drawing styles and on different topics have come out. The format opens up a lot of possibilities: Many scenes and stories can be incorporated in a condensed space, stimulating searching, finding and one's imagination by creating connections between characters and scenes as well as one's own stories. The hidden object map Right to the City hereby portrays a concentration of urban conflicts and struggling for a good life. The picture represents fiction just as much as it represents the truth. It is inspired by encounters, events and struggles. Most of the scenes are the result of places, events, projects and interventions that really exist or took place. The fare-evasion metro in Stuttgart, the riot dog Louk from Greece or the squatting elders from Berlin. Known motifs, logos and also some real people can be recognized.

Often the portrayed protests, events and projects are not shown in a common context they are not told as one coherent story. This leads to the impression that there are many different unconnected struggles as well as protests and forms of resistance on the one hand but also alternatives and possibilities on the other hand. What connects everything, though, is the bird's-eye perspective. As a map, the hidden object map connects the portrayed places and social struggles with each other. Leading through streets and places, the hidden object map leads past the demands of refugees



for social participation just as it does for the disabled, the unemployed, queer or transgender people. The wealth on the one side of the street is opposed by the poverty on the other side of the street. The title Right to the City refers to a self-designation of many urban initiatives all around the globe that demand the access and participation of all residents – and most of all the socially disadvantaged – to the resources of urban society and the right to self-organization and the ability to try new forms of living.

The hidden object map Right to the City was published online, printed and distributed freely in 2016. It is decoration and entertainment as well as educational material and propaganda at the same time. It is put on the walls of kitchens co-tenants share as well as in offices, on the bulletin boards of repair cafés and in the community greens. It can be found at critical mass network meetings as well as in open workshops. Teachers and educators use it in schools, kindergartens or day-care centers. Activists use it in workshops to explain protest forms and alternative approaches of social movements. Some parents have put it on the walls of their children's rooms in order to explain to them which great actions and projects they have participated in (hopefully their children don't find this boring).

But the best way to explore the picture is being at leisure and looking at it on the wall of a restroom – or online where you can zoom into a detailed view of all the scenes and characters: [wimmelbild.animationsfilm.de/wimmelbild-recht-auf-stadt/](http://wimmelbild.animationsfilm.de/wimmelbild-recht-auf-stadt/)

#### Endnotes

1. This article and all its illustrations are licensed under a Creative Commons Attribution-NonCommercial-NoDerivatives 4.0 License (CC BY-NC-ND 4.0).

#### Illustrations

Hidden object map by Markus Wende based on the idea of Marc Amann





**NO LYMPIA!**  
Milliarden Grab!  
beerdigen!  
**DÖDFE!**  
Plakate anbieten verboten

**BER**

**ASAMBLEA**

**Billig-Willich**

**FAHRE STAUFRONT**

**Stuttgart 21**

**Stuttgart 21**

**GEZI-PARK**

**GO VEGAN**

what  
nee



SIE WOLLEN KAPITALISMUS OHNE DEMOKRATIE

WIR WOLLEN DEMOKRATIE OHNE KAPITALISMUS!

BLOCKIERT DIE REICHEN!

WIR WOLLEN DEMOKRATIE OHNE KAPITALISMUS!

Abschiebung ist MORD!

REFUGEES REVOLUTION

REFUGEES WELCOME

HERE ARE TO STAY

IN ATTEN

kein mensch ist illegal

DOKUMENTATION

ACTION

WIR SIND DIE 99%

RAGE AGAINST

LOVE THE WORLD

FREE

KEINE RÄUMUNG DES CAMP!

OPEN AIR RECHTS-BERATUNG

IN ATTEN



**HOW TO**

**BECOME**

INSIGHTS INTO VARIOUS MAPPING GUIDES

**AN OCCASIONAL**

AS A STARTING POINT FOR YOUR PRACTICE

**CARTOGRAPHER**

## How to Become an Occasional Cartographer

### Insights into Various Mapping Guides as a Starting Point for Your Practice

Not-an-Atlas emerges as an attempt to provide insights into the staggering heterogeneity of contexts in which collectives and individuals apply mapping as a manifold tool to underpin their matters. We try to offer a collection that inspires experienced as well as emerging cartographers. The following material for practical involvement invites readers to become occasional cartographers themselves. It presents three excerpts from existing mapping guides that introduce basic practical know-how for mapping processes.

Firstly, in their guide John Krygier and Denis Wood lead through the major steps in mapping processes. They highlight the identification of the public to be addressed and the objectives of the mapping, the use of relevant data and the documentation and critical analysis of the latter. Secondly, the Iconoclastas propose collective mapping as a strategic tool for organizing group processes and challenging hegemonic positions. Readers are encouraged to develop their own mapping practice by using visual resources to stimulate interventions and by considering eleven theses for occasional cartographers. Thirdly, Anna Hirschmann, Raphael Kiczka and Florian Ledermann address problems that may arise within solidary mapping projects, such as instrumentalized data and heteronomous representations. They present an approach for coping with sensitive issues by drawing more attention to the needs of the mapped actors.

Hence, when becoming an occasional cartographer, we suggest to have these mapping guides at hand, to adapt the proposed techniques to your local contexts and to create new tools for your struggles. Finally, by sharing your material and insights you can inspire other counter-cartographers!

Making Maps: A Visual Guide to Map Design for GIS  
Second Edition 2011 - Guilford Press  
(Third Edition already available!)

Manual of Collective Mapping: Critical Cartographic Resources  
for Territorial Processes of Collaborative Creation  
English Edition 2016  
[iconoclastas.net/mapeo-colectivo](http://iconoclastas.net/mapeo-colectivo)

Ein Leitfaden für solidarisches Kartieren  
German Version 2014  
[platzda.blogspot.eu](http://platzda.blogspot.eu)

# *Making* **MAPS**

A Visual Guide to Map Design for GIS

**JOHN KRYGIER and DENIS WOOD**

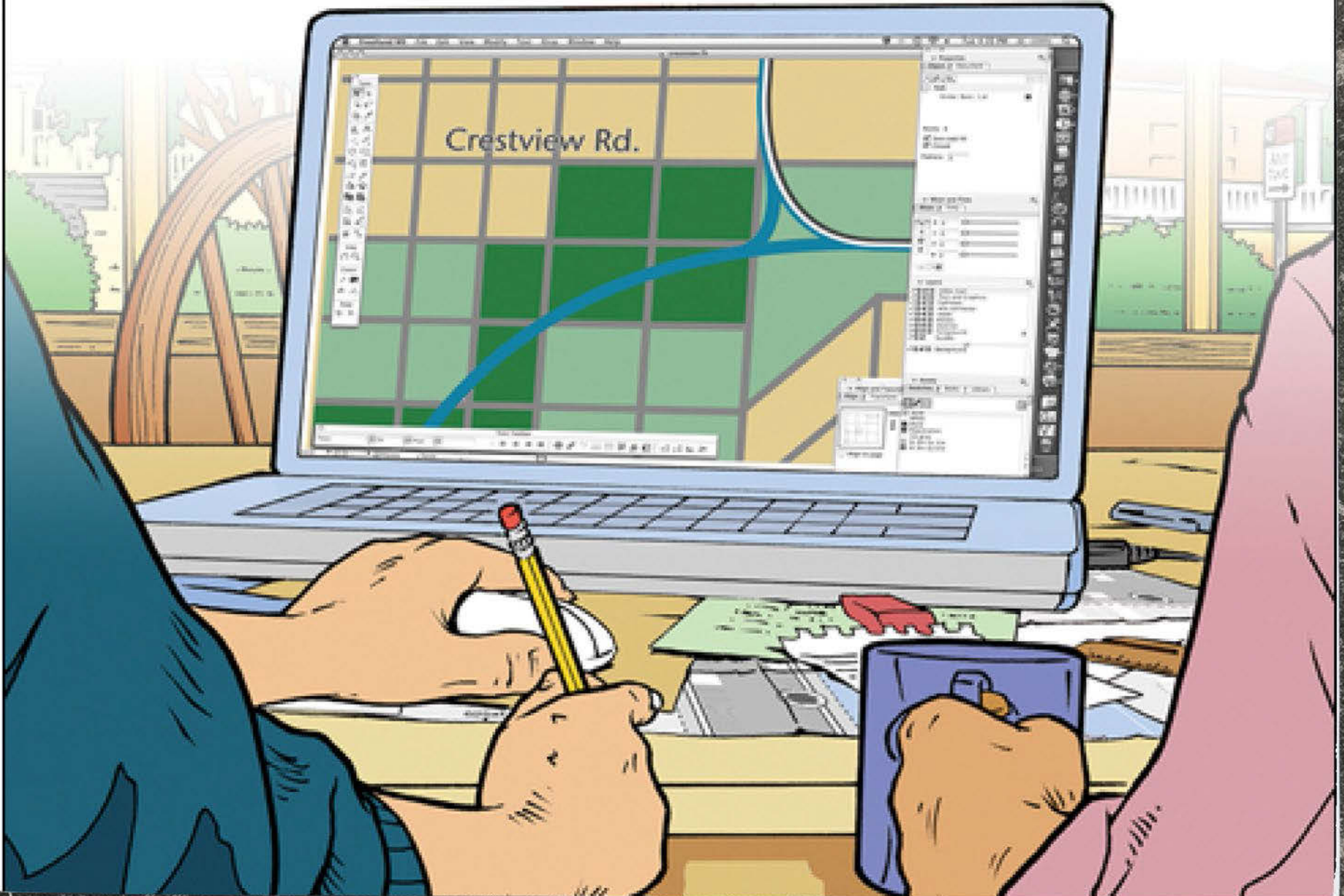

## **Making Maps is Hard**

Whether looking at or making maps, there is a lot to see, think about and do. Throughout this book, myriad subjects are considered in general and in relation to The Flight of Voyager map.

A systematic critique of an existing map or the successful making of your own map is accomplished by considering the following issues.

When making maps, think about everything before starting; Then, when your map is complete, reconsider them all again.



## The Whole Map

Write out exactly what the map is supposed to accomplish:  
Does the map meet its goals?

Are you sure a map is necessary?

Is the map suitable for the intended audience?

Will the audience be confused, bored, interested or informed?

Look at the map in its final medium: Does it work? Has the potential of a black-and-white or color design been reached?

Is the map, its authors, its data and any other relevant information documented and accessible to the map reader?

Look at the map and assess what you see; is it:

- confusing or clear
- interesting or boring
- lopsided or balanced
- amorphous or structured
- light or dark
- neat or sloppy
- fragmented or coherent
- constrained or lavish
- crude or elegant
- random or ordered
- modern or traditional
- hard or soft
- crowded or empty
- bold or timid
- tentative or finished
- free or bounded
- subtle or blatant
- flexible or rigid
- high-contrast or low-contrast
- authoritative or unauthoritative
- complex or simple
- appropriate or inappropriate

Given the goals of the map, are any of these impressions inappropriate?

## The Map's Data

Do the data serve the goals of the map?

Is the relationship between the data and the phenomena they are based on clear?

Does the map symbolization reflect the character of the phenomena or the character of the data?

Does the origin of the data – primary, secondary, tertiary – have any implications?

Are the data too generalized or too complex, given the goals of the map?

Is the map maker's interpretation of the data sound?

Are qualitative and quantitative characteristics of the data effectively symbolized?

Have the data been properly derived?

Has the temporal character of the data been properly understood and symbolized?

Is the scale of the map (and inset) adequate, given the goals of the map?

What about the accuracy of the data? Are the facts complete? Are things where they should be? Does detail vary? When were the data collected? Are they from a trustworthy source?

Have you consulted metadata (data about data)?

Does the map maker document copyright issues related to the data?

Is the map copyright or copyleft licensed?

## What's Your Map For?

What was Twain's map of Paris for? To make us laugh. But first it was to make Twain laugh. It was a dark time for Twain. "He swung between deep melancholy and half-insane tempests and cyclones of humor." In one of the latter moments, "he got a board and with a jackknife carved a 'crude and absurd' map of Paris under siege." The map was a parody of those found in the newspapers of the time and was wildly popular. Who's your map for? How will you show it? How will you document, evaluate and review it? Your answers will profoundly shape your map.



## But Do You Really Need a Map?

The first thing you need to decide is whether you need a map. You may not. There are secrets that don't want to be mapped. There are circumstances where maps are inappropriate. And sometimes there are more effective ways of making your point: a graph, a drawing, a photo.

### The Secret

Sometimes it's better not to map stuff you could easily map. Military sites, sacred indigenous locations and archaeological sites are often left off of maps.



The U.S. Geological Survey topographic map of Raven Rock Mountain in Pennsylvania (above) doesn't show the extensive infrastructure of "Site R" – the bunker where U.S. Vice President Dick Cheney hunkered down after 9/11. Architect John Young tracked down the missing data and mapped it as part of his cryptome.org Eyeballing project (below).

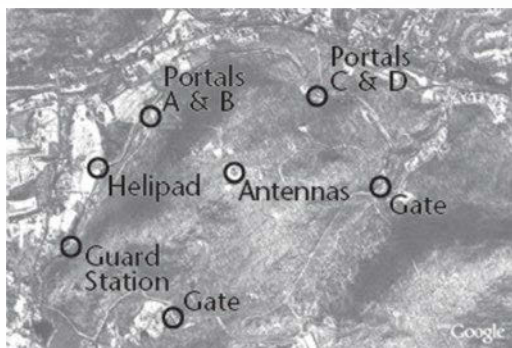

### The Silly

"How surprised are you that Chicago has been eliminated from the potential host cities for the 2016 Olympics?"



### The Not Mappable

Typically land claims by native peoples are accompanied by maps. This is so obviously the place for a map that it seems perverse to question it, but increasingly Indigenous peoples have been arguing that maps can't capture their relationship to the land.

In 1987 the Gitksan and the Wet'suwet'en in British Columbia entered the Gitksan adaawk (a collection of sacred oral traditions about their ancestors, histories and territories) and the Wet'suwet'en kungax (a spiritual song or dance or performance tying them to the land) as evidence in their suit seeking title to their ancestral lands. In 1997 the Canadian Supreme Court found that forms of evidence like these had to be accepted in Canadian courts.

## Who's Your Map For?

Knowing the intended audience for your map will help you design it. Your audience may or may not be familiar with the area being mapped, an expert on the mapped topic or a novice, an eight-year-old or a college student. In each case, consider how your map can function better for the people who will actually use it.

### Experts

Experts know a lot about the subject of the map. Experts are highly motivated and very interested in the facts the map presents. They expect more substance and expect to engage a complex map.

- Less peripheral information on map explaining content and symbols
- More information, more variables of information, more detail
- Follow conventions of experts: consider using a spectral (rainbow) color scheme for ordered data if the user is accustomed to using such colors to show ordered data (such schemes are usually not good for other users)

### Novices

Novices know less about the map subject and may not be familiar with the way maps are symbolized. They need a map that is more explanatory. Novices may be less motivated than expert users, but they want the map to help them learn something.

- More peripheral information on map explaining content and symbols
  - Less information, fewer variables of information, less detail
  - Follow map design conventions, which enhance comprehension of the map

```

( 1 ) ( 1 ) ( 2 ) ( 2 ) ( 3 ) ( 3 )
( 1 ) ( 1 ) ( 2 ) ( 2 ) ( 3 ) ( 3 )
      ( 4 ) ( 4 ) ( 5 ) ( 5 ) ( 6 ) ( 6 )
      ( 4 ) ( 4 ) ( 5 ) ( 5 ) ( 6 ) ( 6 )
      ( 7 ) ( 7 ) ( 8 ) ( 8 ) ( 9 ) ( 9 ) ( 10 ) ( 10 ) ( 11 ) ( 11 )
      ( 7 ) ( 7 ) ( 8 ) ( 8 ) ( 9 ) ( 9 ) ( 10 ) ( 10 ) ( 11 ) ( 11 )
      ( 12 ) ( 13 ) ( 14 ) ( 15 ) ( 16 ) ( 17 ) ( 17 ) ( 18 ) ( 18 ) ( 19 ) ( 19 )
(205)(205)      ( 20 ) ( 21 ) ( 22 ) ( 23 ) ( 24 ) ( 25 ) ( 17 ) ( 17 ) ( 18 ) ( 18 ) ( 19 ) ( 19 )
(205)(205)( 26 ) ( 27 ) ( 28 ) ( 29 ) ( 30 ) ( 31 ) ( 32 ) ( 33 ) ( 34 ) ( 35 ) ( 36 ) ( 36 ) ( 37 ) ( 37 ) ( 38 ) ( 38 )
(204)(204)( 39 ) ( 40 ) ( 41 ) ( 42 ) ( 43 ) ( 44 ) ( 45 ) ( 46 ) ( 47 ) ( 58 ) ( 36 ) ( 36 ) ( 37 ) ( 37 ) ( 38 ) ( 38 )
(204)(204)( 49 ) ( 50 ) ( 51 ) ( 52 ) ( 53 ) ( 54 ) ( 55 ) ( 56 ) ( 57 ) ( 58 ) ( 59 ) ( 59 ) ( 60 ) ( 60 ) ( 61 ) ( 61 ) ( 62 ) ( 62 )
( 63 ) ( 63 ) ( 64 ) ( 64 ) ( 65 ) ( 66 ) ( 67 ) ( 68 ) ( 69 ) ( 70 ) ( 71 ) ( 72 ) ( 73 ) ( 74 ) ( 59 ) ( 59 ) ( 60 ) ( 60 ) ( 61 ) ( 61 ) ( 62 ) ( 62 )
( 63 ) ( 63 ) ( 64 ) ( 64 ) ( 75 ) ( 76 ) ( 77 ) ( 78 ) ( 79 ) ( 80 ) ( 81 ) ( 82 ) ( 83 ) ( 84 ) ( 85 ) ( 85 ) ( 86 ) ( 86 ) ( 87 ) ( 87 ) ( 88 ) ( 88 ) ( 89 ) ( 89 )
( 90 ) ( 90 ) ( 91 ) ( 91 ) ( 92 ) ( 93 ) ( 94 ) ( 95 ) ( 96 ) ( 97 ) ( 98 ) ( 99 ) ( 100 ) ( 101 ) ( 85 ) ( 85 ) ( 86 ) ( 86 ) ( 87 ) ( 87 ) ( 88 ) ( 88 ) ( 89 ) ( 89 )
( 90 ) ( 90 ) ( 91 ) ( 91 ) ( 102 ) ( 103 ) ( 104 ) ( 105 ) ( 106 ) ( 107 ) ( 108 ) ( 109 ) ( 110 ) ( 111 ) ( 112 ) ( 112 ) ( 113 ) ( 113 ) ( 114 ) ( 114 ) ( 115 ) ( 115 )
( 116 ) ( 116 ) ( 117 ) ( 117 ) ( 118 ) ( 119 ) ( 120 ) ( 121 ) ( 122 ) ( 123 ) ( 124 ) ( 125 ) ( 126 ) ( 127 ) ( 112 ) ( 112 ) ( 113 ) ( 113 ) ( 114 ) ( 114 ) ( 115 ) ( 115 )
( 116 ) ( 116 ) ( 117 ) ( 117 ) ( 128 ) ( 129 ) ( 130 ) ( 131 ) ( 132 ) ( 133 ) ( 134 ) ( 135 ) ( 136 ) ( 137 ) ( 138 ) ( 138 ) ( 139 ) ( 139 ) ( 140 ) ( 140 )
( 141 ) ( 141 ) ( 142 ) ( 142 ) ( 143 ) ( 144 ) ( 145 ) ( 146 ) ( 147 ) ( 148 ) ( 149 ) ( 150 ) ( 151 ) ( 152 ) ( 138 ) ( 138 ) ( 139 ) ( 139 ) ( 140 ) ( 140 )
( 141 ) ( 141 ) ( 142 ) ( 142 ) ( 153 ) ( 154 ) ( 155 ) ( 156 ) ( 157 ) ( 158 ) ( 159 ) ( 160 ) ( 161 ) ( 162 ) ( 163 ) ( 163 )
( 164 ) ( 164 ) ( 165 ) ( 165 ) ( 166 ) ( 167 ) ( 168 ) ( 169 ) ( 170 ) ( 171 ) ( 172 ) ( 173 ) ( 174 ) ( 175 ) ( 163 ) ( 163 )
( 164 ) ( 164 ) ( 165 ) ( 165 ) ( 176 ) ( 177 ) ( 178 ) ( 179 ) ( 180 ) ( 181 ) ( 182 ) ( 183 ) ( 184 ) ( 185 )
      ( 186 ) ( 186 ) ( 187 ) ( 187 ) ( 188 ) ( 188 ) ( 189 ) ( 189 ) ( 190 ) ( 190 ) ( 191 ) ( 191 )
      ( 186 ) ( 186 ) ( 187 ) ( 187 ) ( 188 ) ( 188 ) ( 189 ) ( 189 ) ( 190 ) ( 190 ) ( 191 ) ( 191 )
      ( 192 ) ( 192 ) ( 193 ) ( 193 ) ( 194 ) ( 194 ) ( 195 ) ( 195 ) ( 196 ) ( 196 )
      ( 192 ) ( 192 ) ( 193 ) ( 193 ) ( 194 ) ( 194 ) ( 195 ) ( 195 ) ( 196 ) ( 196 )
      ( 197 ) ( 197 ) ( 198 ) ( 198 ) ( 199 ) ( 199 ) ( 200 ) ( 200 )
      ( 197 ) ( 197 ) ( 198 ) ( 198 ) ( 199 ) ( 199 ) ( 200 ) ( 200 )
      ( 201 ) ( 201 ) ( 202 ) ( 202 ) ( 203 ) ( 203 )
      ( 201 ) ( 201 ) ( 202 ) ( 202 ) ( 203 ) ( 203 )
    
```

### Mike...

Social worker Mike Rakouskas's map of Wake County, North Carolina. The numbers refer to pages in the county street atlas he uses, and the shaded numbers are client sites. He uses this map to rationalize his trip planning and as an index to the atlas. It was made with a word processor. Peculiar! Clever! And perfect for Mike.

## How Are You Going to Show It?

Consider the final medium of your map before making it. Most maps are made on computer monitors, but the monitor is not the final medium. Rather, it might be a cell phone screen, a piece of paper, a poster, a slide projected on a screen during a presentation, a yard sign, handbill or protest sign. What looks great on your computer will probably not look so great when printed or projected or shown on a tiny phone screen.

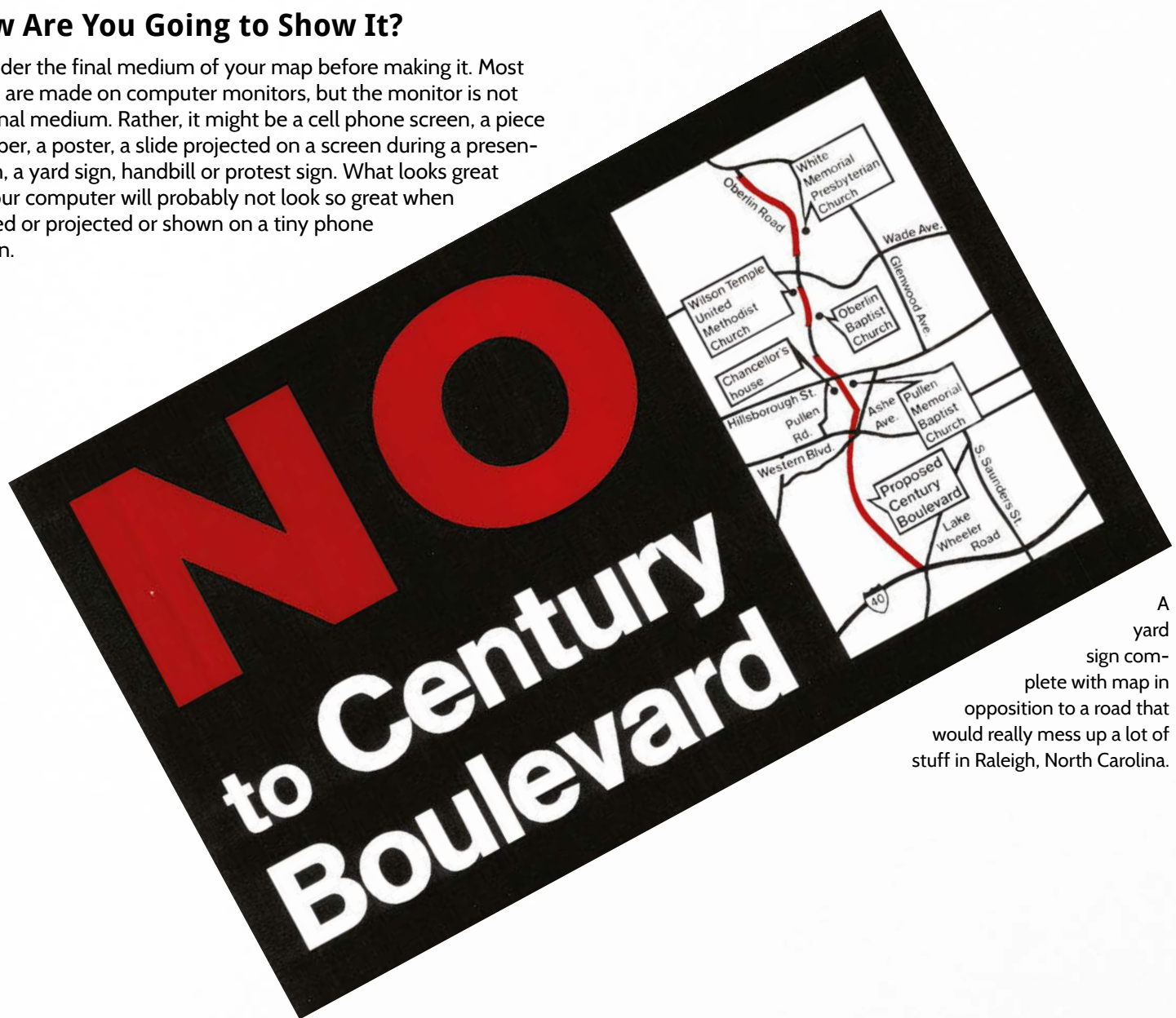

A yard sign complete with map in opposition to a road that would really mess up a lot of stuff in Raleigh, North Carolina.

## **Black and White, on Paper**

Most maps are created on computer monitors, with less resolution and area than is possible on a piece of paper. When paper is your final medium, design for the paper and not for the monitor. Always check design decisions by printing the map (or having your printer create a proof if your map is to be professionally printed). While all computers offer color, final printing with color is not always an option. Don't despair! Much can be done with black and white.

Map size should match final paper size, with appropriate margins.

10-point type works well on a printed map, but you may have to zoom in to see it on the computer monitor.

Point and line symbols can be smaller and finer on a printed map than on the computer.

More subtle patterns can be used than on a computer monitor map.

More data and more complex data can be included on a printed map.

Substitute a range of grays and black and white for color. Remember that printers cannot always display as many grays as you can create on a monitor; subtle variations in grays may not print clearly.

Black will be more intense than white; use white to designate no information or the background, dark to designate more important information.

Monochrome copiers sometimes reproduce gray tones poorly.

Very light gray tones may not print.

## Color, on Paper

Color on a computer monitor is created in a different manner than color on desktop printers or on professionally printed maps. Select colors on the computer, then print and evaluate (or ask for a proof). Always design for the final medium: Adjust the colors on the monitor so they look best for the final output. The same colors will vary from printer to printer. Reproducing color is often more expensive than black and white. Finally, keep in mind that users may reproduce your color map in black and white. Will it still work?

Map size should match final paper size, with appropriate margins.

10-point type works well on a printed map but you may have to zoom to see it on the computer monitor.

Point and line symbols can be smaller and finer on a printed map.

More subtle patterns can be used than on a computer monitor map.

More data and more complex data can be included on a printed map.

Use color value (e.g., light red vs. dark red) to show differences in amount or importance. Use color hue (blue vs. red) to show differences in kind. Desktop printers cannot display as many colors as you can create on a monitor; subtle variations in colors may not print.

Dark colors are more intense than light; use light colors to designate less important information and background, and dark to designate more important information.

Never print a color map in black and white; redesign it for black and white.

## Computer Monitors

Designing maps for final display on a computer must take screen resolution and space limits into account. Desk or laptop computer monitor resolution is typically 72 dots per inch (dpi), compared to 1200 or more for many printers. Computer monitors also have limited area, typically 7 by 9 inches, or less if the map is displayed in a web browser window. Design a map so that all type and symbols are visible without magnification. Also avoid maps that require the viewer to scroll around to see the entire map. Use more than one map if you need more detail, or consider web tools that allow you to zoom and pan over a map.

The entire map should fit on the screen without scrolling (if pan/zoom is not possible).

Increase type size: 14 point type is the smallest you should use on a monitor.

Make point and line symbols 15% larger than those on a paper map.

Use more distinct patterns: avoid pattern variations that are too fine or detailed.

You may have to limit the amount and complexity of data on your map compared to a print map.

Use color but remember that some monitors cannot display billions of colors; subtle color variations may not be visible on every monitor.

White is more intense than black. Take care when using white to designate the lack of information or as background color, it may stand out too much.

Save static maps for the internet at 72-150 dpi. Size the map to fit in a browser window.

Design your map so it works on different monitors (RGB, LCD, portables).

Interactive maps require attention to additional issues, such as pan, zoom, interactivity, etc.

Sony Ericsson Xperia

## Portable Monitors

Maps on smart phones, PDAs, GPS units, and other portable devices pose the same design challenges as on desktop monitors, with the further limitation of screen size. Typical portable monitor sizes are shown on this spread. Many portable monitors are touch-sensitive, allowing users to pan and zoom, thus overcoming some of the limitations of the small monitor size.

Static maps on portable devices can follow desktop monitor design guidelines, taking into account the limited display size into account.

Interactive maps should use appropriate interface metaphors: Zooming in is “up” on a slider bar, or two fingers diverging outward. Pan is touch and slide in the appropriate direction.

Interactive maps should vary map design specifications with scale.

Generalize more as the user zooms out on the map: For example, local roads and road names disappear when zoomed out.

Generalize less as the user zooms in on the map: Local roads and their names appear when zoomed in.

Aerial photographs may be more appropriate than maps for users with limited navigation abilities.

Ground-view images may be more helpful for navigation than maps alone, but using both should increase navigation success.

Map symbols should not be too complex.

Colors should be more intense to account for varying lighting conditions.

Serif fonts may be easier to read on portable monitors than sans serif.

LG + Samsung

Centro

Treo



Nokia Tube

QVGA Type 2.2

Palm TX

Apple iPhone

## Projections

It is increasingly common for maps to be shown on a large screen with a computer projector. When projected, white and lighter colors will be more intense, black and darker colors subdued. Computer projectors vary in the amount of light they can project. Some projectors wash out colors. Consider previewing your projected map and adjusting the projector. Projected maps must be designed with the viewing distance in mind (find out the size of the room). A map projected to an audience in a small room can have smaller type and symbols than a map projected in an auditorium. Always check that the map is legible from the back of the room in which the map will be displayed.

Greater map size is offset by the increased viewing distance.

Increase type size so that the smallest type is legible from the back of the room.

Increase point and line symbol size to be legible from the back of the room.

More distinct patterns: Avoid pattern variations that are too fine or detailed.

You may have to limit the amount and complexity of data on your map compared to print maps.

Older or lower-output projectors may wash out colors, so intensify your colors for projection.

If your map will be projected in a dark room, use black as background, darker colors for less important information and lighter colors for more important information.

If your map will be projected in a well-lighted room, use white as background, lighter colors for less important information and darker colors for more important information.

# Guide Psychogéographique de OWU



## Posters

Posters are similar to projected maps, although usually viewed in well-lighted conditions. Viewers should be able to see key components of the map (such as the title) from afar, then walk up to the map and get more detail. Design the poster so information can be seen both close and at a distance. The size of poster maps is limited by the largest printer you can use; always check color and resolution of the printer used to reproduce your poster. You may want to request a test print of the colors you plan to use to evaluate your color choices.

Design map title and mapped area so they are legible from across the room.

The majority of type, point and line symbols should be slightly larger than on a typical printed map but not as large as on a monitor or projected map. Design this part of the map so it is legible at arm's length.

More complex information can be included on a poster map than on a computer monitor or projected map.

Follow color conventions for color-printed maps. Most posters are viewed in a well-lighted room, so use white as background, lighter colors for less important information and darker colors for more important information.

Left: A portion of the poster-sized map Guide Psychogéographique OWU, made by a group of middle-school students and John Krygier during a summer class, Mapping Weird Stuff, at Ohio Wesleyan University, June 2009.

## Document, Evaluate, Review

Constantly cast a critical eye on your work. Document what you do and continually evaluate whether the map is serving its intended goal, meeting the needs of its intended audience and working well in its final medium.

NASA's Bob Craddock set about revising a 1986 map of Mars with new imagery from the Viking Orbiter. Craddock transferred details from the 1986 map while referencing his new data, drawing lines and labeling what he thought he saw, evaluating the data as he worked. Craddock used the old interpretations when the new data supported them and modified features clarified by the new data.

When complete, the new map was sent to other experts for review and evaluation. The reviewers annotated the map wherever they disagreed with Craddock's interpretations or saw alternatives. Craddock, in turn, revised his map with the reviewers' comments, not necessarily agreeing with all of them but, in the end, producing a map of the geology of Mars that was better because of the expert evaluation and review.

## Documentation

What were those six great shades of red I used on that map I made last month? What font did I use on the last poster map I made? How big was the title type? How long did it take me to make that map for the annual report last year? Where did we get that great data set? Was it licensed? Who printed that large format map for us last year? How much did it cost to print and fold those color maps?

Documentation of the details involved in making a map may seem tedious but can save time and effort in future map making, both for yourself and others who may need to make similar maps. Working toward a few general styles that are effective for specific types of commonly produced maps is useful. Documentation of mapped data is vital if the map is to be published.



### Documenting General Issues

Document your goal for the map and

- ...the intended audience and what you know about them
- ...the final medium and details about the medium that will affect map design and reproduction
- ...the amount of time it takes to create the map, and any major problems and how you solved them

Keep copies of the map as well as information on where it was published or presented

### Documenting Data

Document the source of the data, including contact information and copyright information

- ...the age, quality, and any limitations of the data
- ...how the data were processed into a form appropriate for mapping
- ...map projection and coordinate system information

### Documenting Design

Document specifics of map size, scale, and sketches of layouts

- ...a list of information on the map, arranged in terms of importance, and associated symbols
- ...data classification and generalization information
- ...sources and details of map symbols
- ...details of type size, font, etc.
- ...color specifications for all colors used
- ...design problems encountered and solutions
- ...software problems encountered and solutions

### Formative Evaluation

Ongoing formative evaluation is as simple as asking yourself whether the map is achieving its goals throughout the process of making the map. Formative evaluation implies that you will “re-form” the map so it works better or maybe even dump it! It is never too late to bail out if the map is not serving your needs. It is a good idea to ask others to evaluate your map as well: What do you think of those colors? Can you read that type from the back of the room? Does what is most important on the map actually stand out? What is the boss going to think? Simply engaging your mind as you make your map, and being open to critique and change, will lead to a better map.

#### Ask yourself...

Is this map doing what I want it to do?

Will this map make sense to the audience I envision for it?

How does the map look when printed, projected, or viewed in the final medium, and what changes will make it better?

Are the chosen scale, coordinate system and map projection appropriate?

Do the layout of the map and the map legend look good? Could it be adjusted to help make the map look better and easier to interpret?

Does the most important information on the map stand out visually? Does less important information fall into the background?

Are data on the map too generalized or too detailed, given the intent of the map?

Does the way I classified my facts help to make sense of them? Would a different classification change the patterns much?

Do chosen symbols make sense, and are they legible?

Is the type appropriate, legible, and is its size appropriate, given the final medium?

Is color use logical (e.g., value for ordered data, hue for qualitative data) and appropriate, and will the chosen colors work in the final medium?

Do I want a series of simpler maps, or one more complicated one?

Is a handout map needed, if presenting a map on a poster or projected?

...then re-form your map.

## Impact Evaluation

Impact evaluation is a range of informal and formal methods for evaluating the finished map. It may be your boss or a publisher reviewing the map, or it may be public feedback on the efficacy. You should begin any map making with a clear sense of who may have the final say on the acceptability of your map, and factor in their wants, needs, and requirements at the beginning of the process.

## Caribou Calving Areas

Arctic National Wildlife Refuge (ANWR)

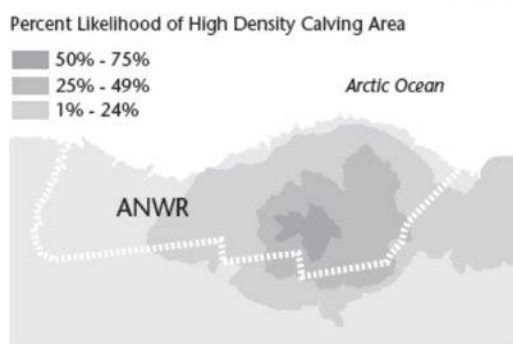

Ian Thomas, a contractor for the U.S. Geological Survey, was fired, allegedly for making maps of caribou calving areas in the ecologically and politically sensitive Arctic National Wildlife Refuge. Thomas argues he was fired for publicizing facts that would undermine the push for oil exploration in the refuge. Others claim the maps were of out-of-date information beyond Thomas's area of expertise and had nothing to do with his being fired. In either case, it is obvious that making maps can piss off your boss.

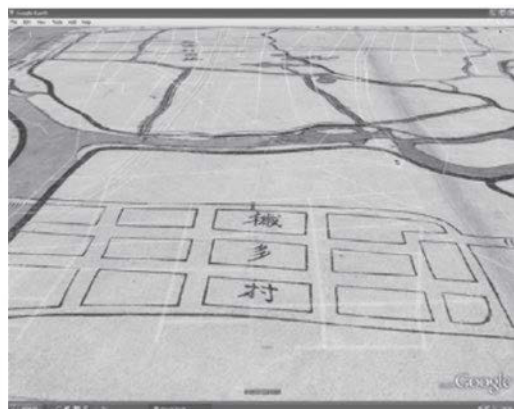

An old Japanese map from the David Rumsey digital map collection was added to Google Earth in early 2009. A label on the map described a village as populated by "eta," the untouchable caste of burakumin (translation, "filthy mass"). Because some idiots in Japan discriminate against the burakumin, it is common practice to remove such references. Rumsey initially decided not to censor the map, but after an uproar the offending nomenclature was removed.

The Flight Of Voyager map was published in 1987 in the book *Voyager* by Jeana Yeager, Dick Rutan and Phil Patton.

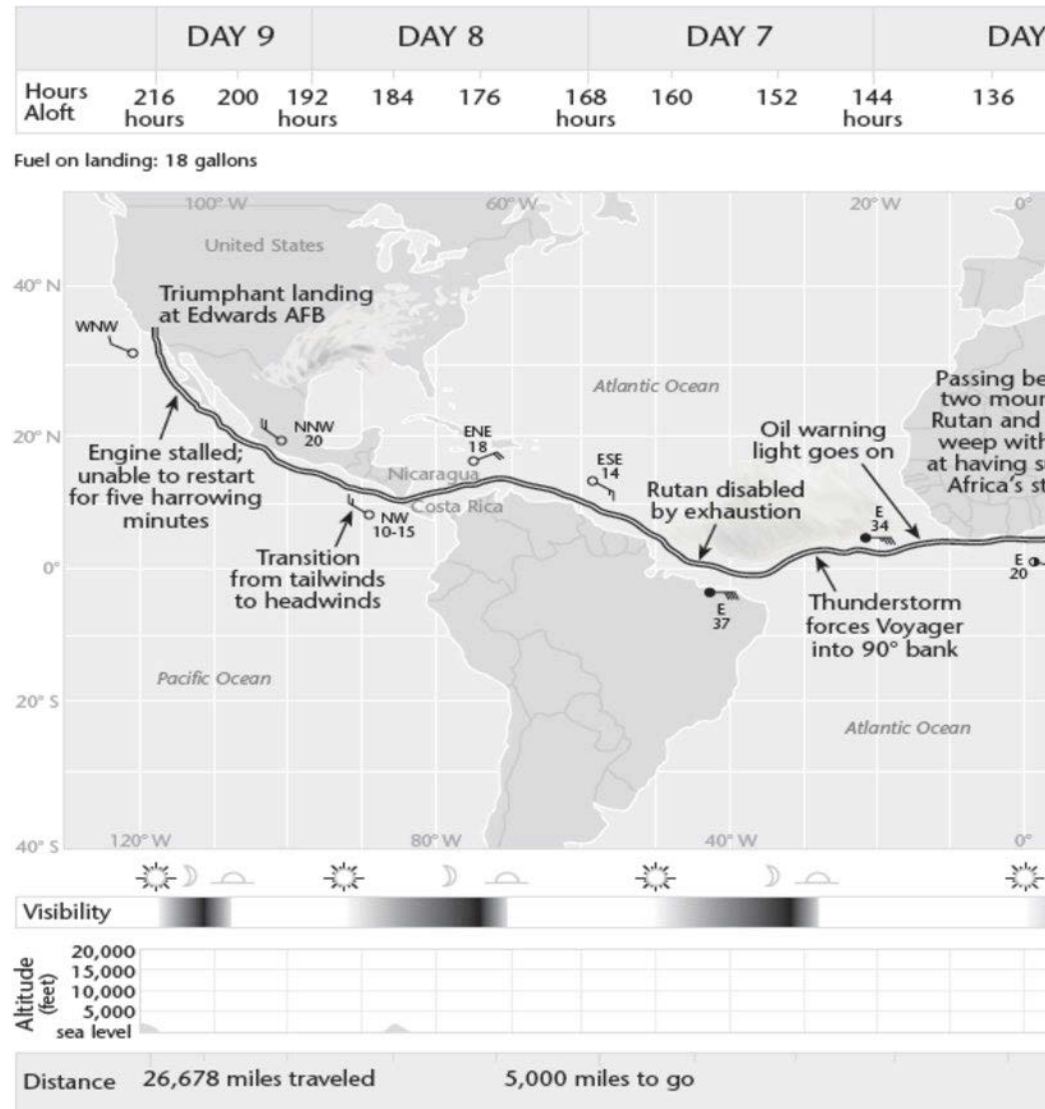

Flight data courtesy of Len Snellman and Larry Burch, Voyager meteorologists  
 Mapped by David DiBiase and John Krygier, Department of Geography, University of Wisconsin-Madison

David DiBiase and John Krygier designed and made a map to tell the story of Voyager and its pilots. The map was created for a map design course at the University of Wisconsin-Madison taught by David Woodward.

The map was split between the front and back book end-papers, half in the front and half in the back. Each endpaper was 9" high and 12" wide.

The map was designed to be viewed at arm's length.

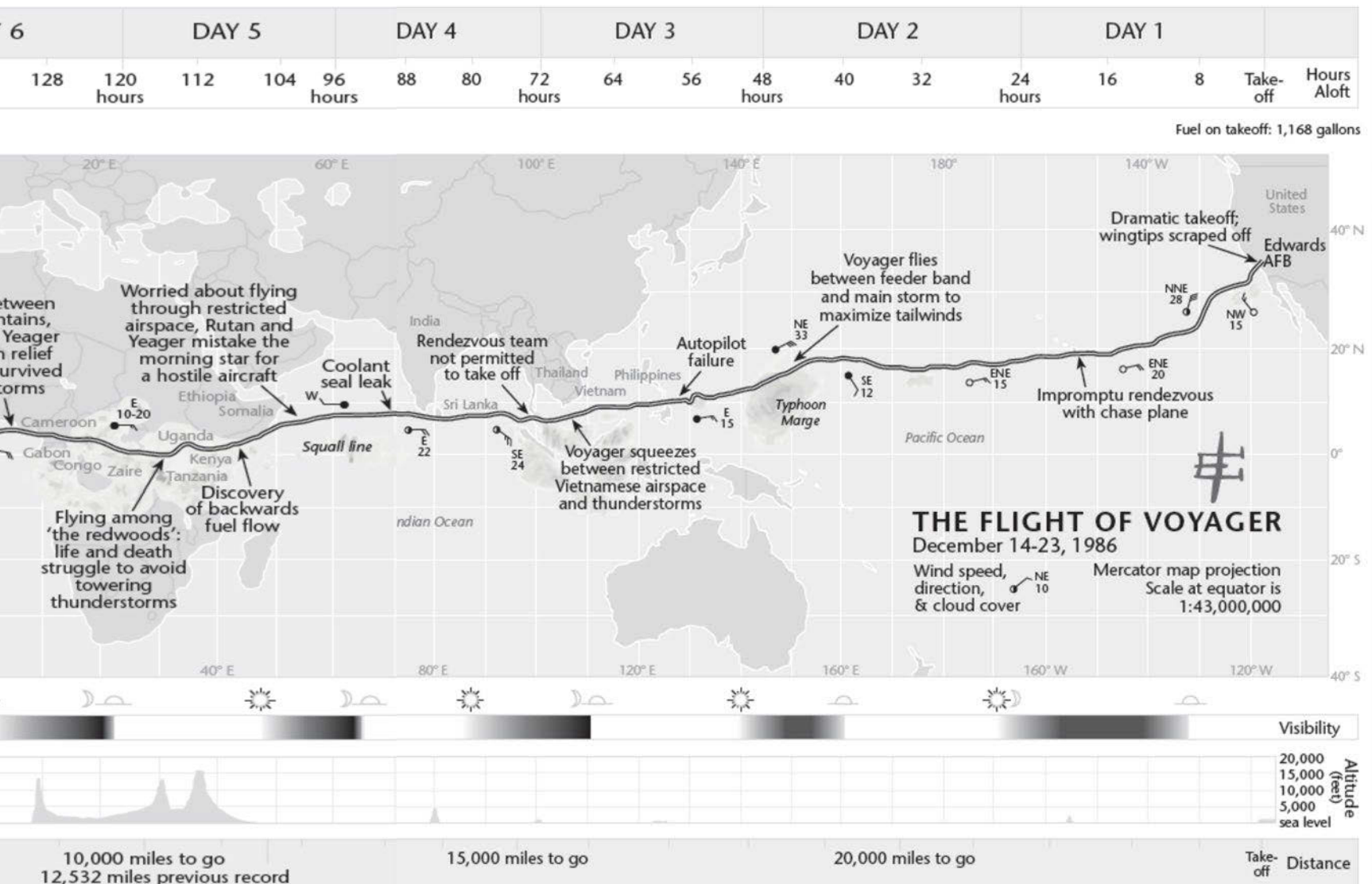

Madison, 1987

Voyager pilots: Dick Rutan and Jeana Yeager  
Voyager designer: Burt Rutan

The map was made for readers of the book *Voyager* (1987) with its general, educated audience, including those with a specialist interest in flight and aerospace. Given the audience, the map was designed to contain a significant amount of information, including detailed data, sure to resonate with pilots.

The publisher of *Voyager*, Knopf, allowed us black and one color for the map. We chose deep red for the most important information (such as the flight path and related text). The map was redesigned in monochrome for *Making Maps*, 2<sup>nd</sup> Ed. The map still works!

Details of the design of the map – line weights, type size, percent gray of different areas on the map, etc. – were documented, as we were taught in David Woodward's course and at the University of Wisconsin-Madison Cartographic Lab. Formative evaluation was ongoing throughout the process, and the editors at Knopf provided the final edit and evaluation of the map.

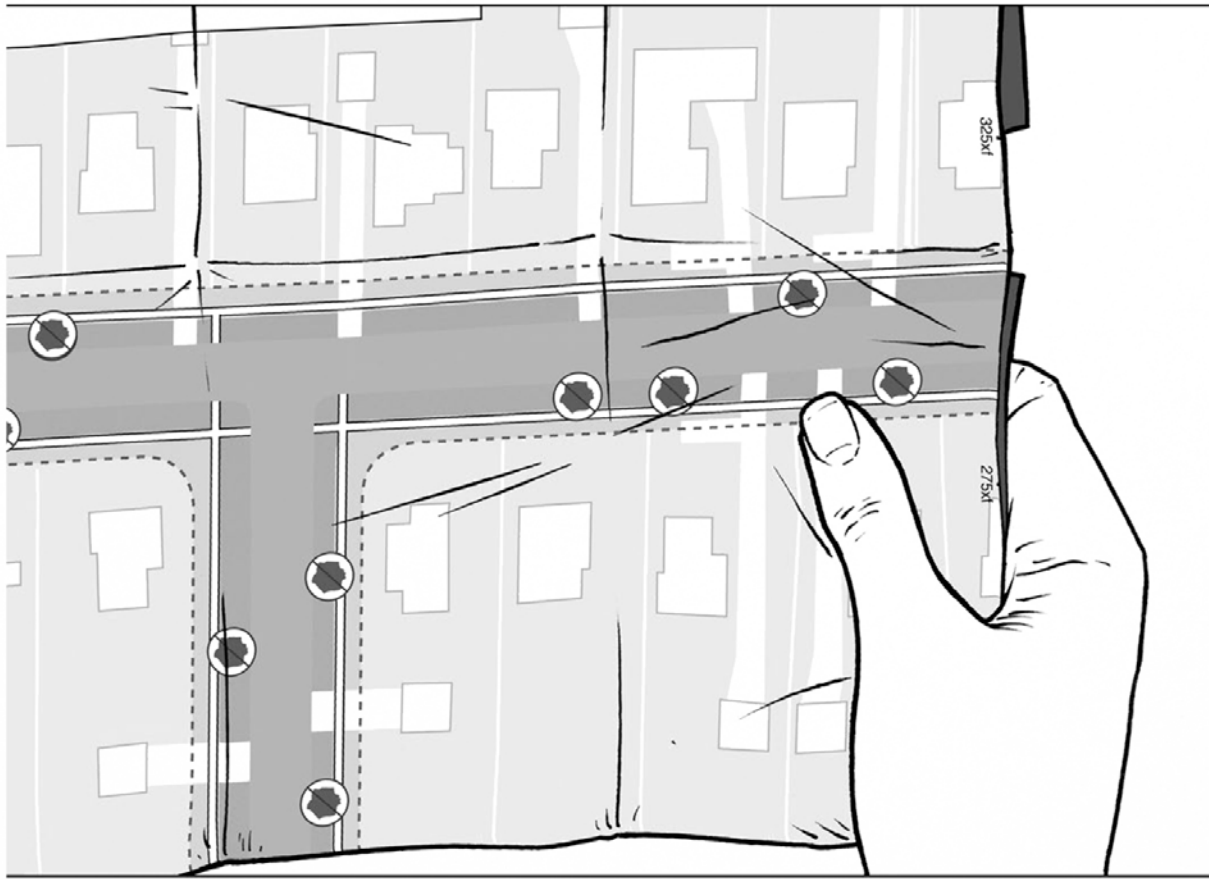

*Making*  
**MAPS**  
A Visual Guide to Map Design for GIS  
JOHN KRYGIER and DENIS WOOD



ICONOCLASISTAS

# Manual of Collective Mapping

CRITICAL CARTOGRAPHIC  
RESOURCES FOR  
TERRITORIAL PROCESSES  
OF COLLABORATIVE  
CREATION

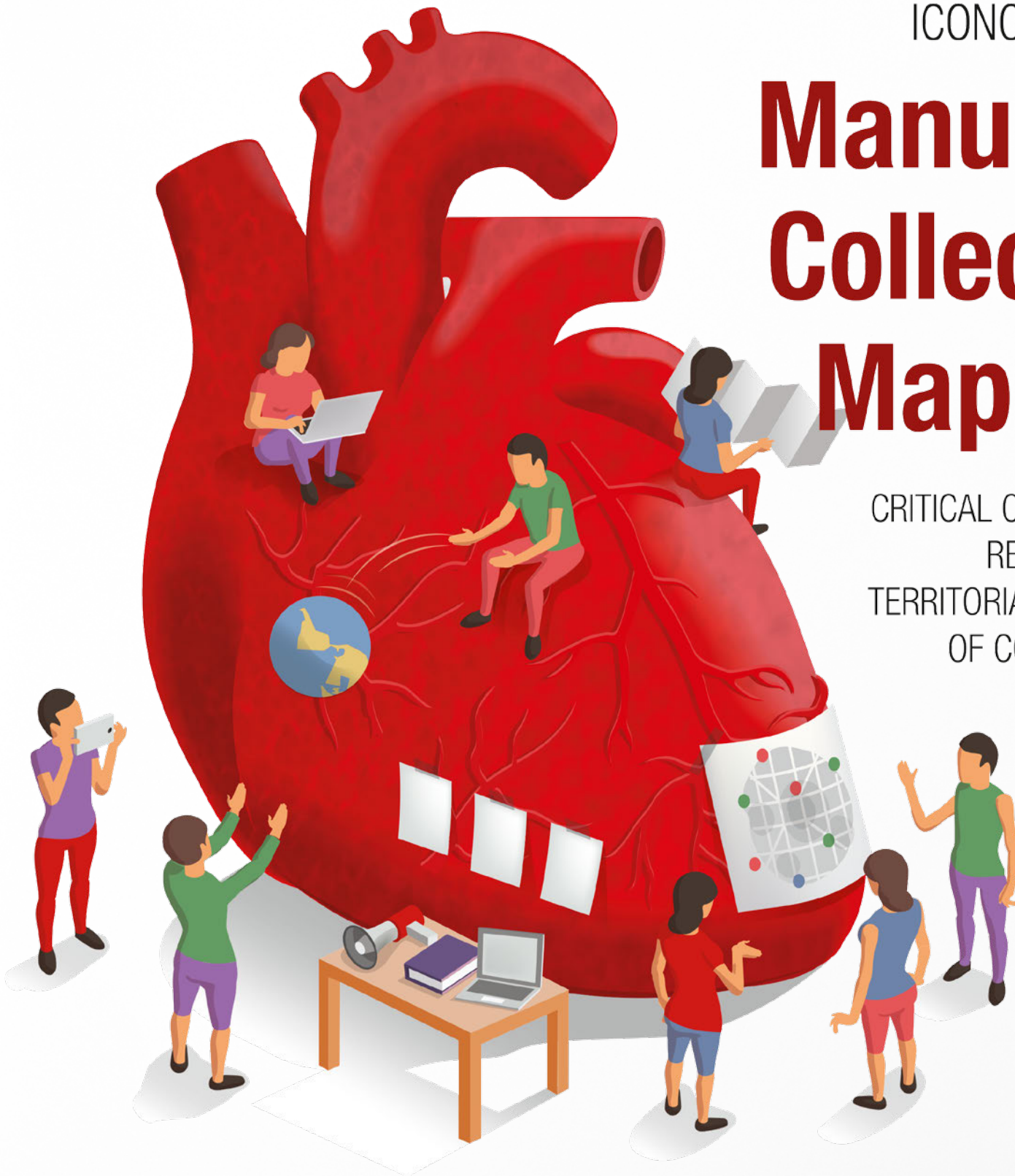

# #1 Mappings, critical accounts, and collective creation

Since 2008 we have been offering mapping workshops to build collectively territorial viewpoints which foster and promote collaborative and transformational practices. This book systematizes methodologies, resources, and dynamics of critical pedagogy to encourage their appropriation and derivative use. We also share experiences of our own. We have chosen some of them from our workshops.

## About the manual

This book is the result of the joint work and collaborative process that started more than five years ago when we were just organizing the first mapping workshops. Through these workshops we have designed a collective practice nurtured with multiple viewpoints, approaches, and variations acquired throughout this experience. This process was gradually recorded in the reports we wrote at the end of workshops. In those reports we aimed at reflecting and highlighting the key resources and moments that emerged during those workshops. In this way, along with practice, thoughts on it were developed. The process was shared: everything was published in the website and spread on social media.

Many of you might be asking yourselves, why, then, write a manual? Almost every day we receive invitations, questions, and doubts about the mapping workshops, which include requests of assistance or requests to design specific resources. Mostly we cannot answer every doubt nor participate in every event, basically because we are just two people. While we often answer these requests by redirecting them to the website, we would like to emphasize the foundations guiding every action of Iconoclastas: to avoid specializations and to free up resources, encouraging anyone interested to set up their own workshops and develop their own practices.

With this manual we share our experience to show how mapping workshops may promote various ways of understanding. Another task developed in workshops is to mark the space using different types of languages, such as symbols, graphics, and icons, stimulating the creation of collages, phrases, drawings, and slogans. There are two meanings of the word "manual" that we want to mention because we like them very much and they illustrate clearly

what we are seeking: one meaning refers to that "done with the hands", and the other one points to any "book giving the essential information on a subject." This is our path, we hope you will enjoy it as much as we do.

## The need to create new accounts

Maps are ideological representations. Drawing maps is one of the main instruments leading powers have recurred to in history for the utilitarian appropriation of territories. This kind of operation involves not only a type of organization of the territory but also the demarcation of borders to mark occupations and plan strategies of invasions, looting, and appropriation of common goods. In this way, maps of wide circulation are the result of the viewpoint that the leading power recreates on the territory generating hegemonic representations functional to the development of capitalism, decoding the territory in a rational way, classifying natural resources, the characteristics of the population, and identifying the kind of production which is more effective in turning labor force and resources into profit.

Official accounts and cartographies are accepted as natural and unquestionable representations despite the fact that they are the result of "interested viewpoints" held by hegemonic powers over territories. We refer not only to those viewpoints from political and social institutions or agents, but also to the discourse of mass media, and to every other intervention shaping public opinion and reinforcing naturalized beliefs and social mandates.

This scientific point of view on the territory, common goods, and on those who inhabit it is supplemented with other techniques penetrating the social body, such as video surveillance, biometric techniques of identification, and statistical formulas constructing situations and offering information to ease the execution of biopolitical

## #1 Mappings, critical accounts, and collective creation

mechanisms directed towards organizing, controlling, and disciplining the inhabitants of a territory.

Nonetheless, the critical use of maps aims at creating the conditions for collective exchange to generate accounts and representations fighting against and challenging those which are established by various hegemonic positions. Designing collective cartographies stems from a deep-rooted tradition of participatory work. Involving different types of experiences and results, this tool has been strengthened by the work of social organizations, NGOs, and foundations, in urban as well as in rural areas. Added to this, technological availability and the access to georeferencing tools (such as GPS or GIS) have invigorated and widened this process in various lines of work.

The diffusion and widespread use of maps and cartographies ran parallel to the “death of grand narratives,” the hegemonic discourse organizing the interpretative paradigm of the 90s. In that decade a vast group of social movements sprung up and made themselves visible in Latin America. These were self-managed and horizontally organized, and sparked demands of peasants, native peoples, gender collectives, among others. These new or renewed social prominent positions recurred to a vast reservoir of liberating practices and discourses, and established a political, cultural and communicational activism linked to social and affective cooperation, the free circulation of knowledge and practices, and the connection through networks.

## Definitions and certainties

We conceive “mapping” as a practice, an action of thought in which the map is only one of the tools promoting an approach and deep analysis of social, subjective, and geographic territories. Added to this, another series of resources have been named “multiple devices” consisting of graphic and visual means and creations. These, when mixed with ludic dynamics, become intertwined to promote areas for socialization and debate, becoming triggers and challenges in constant movement, change and appropriation. In this way, we try to build a space for discussion and creation, not closed in itself, but placed as an available starting point for anyone to recur to, a proper device that builds knowledge, fostering the organization and the generation of liberating alternatives.

This is the reason why we sustain mapping is a means, not an end. Mapping should be part of a wider process, “another strategy”, a “means for” thoughts, the socialization of knowledge and practices, a boost for collective participation, a challenge to hegemonic areas, the driving force for creation and imagination, a deep analysis of key issues, the visualization of resistances, the mark highlighting power relations, among many other aspects.

In this way, mapping does not lead to transformations by itself. Mapping is connected to an organizational process by way of collaborative work in graphic and visual platforms. And this work must be strategically spread: all the information included must be agreed by consensus with everyone taking part of the process and should bear a communicational aim, having in mind that this should not menace nor damage participants.

## Projections and limits to mapping

“Maps are not the territory”: they are static images that cannot capture the constant changes to which territories are exposed. Maps do not contemplate the subjectivity of territorial processes, their symbolic representations nor the imaginaries about them. The people who inhabit the territory are the ones who can really create and transform them, they shape them every day by inhabiting them, going through them, perceiving and creating them.

Mapping is a tool providing a snapshot of the moment in which it was taken, yet it does not recover completely a territorial reality, which is always problematic and complex. Drawing collective maps transmits a specific notion on a dynamic and constantly changing territory, where borders, both real and symbolic, are continually altered and exceeded by the actions of bodies and subjectivities.

Drawing a map involves a way of creating collective accounts on what is common to us all, this builds a platform rendering visible certain contacts and consensus without reducing diversity, for this is also depicted. Brewing the common, i.e., to produce the common that joins us and that we recognize, or rendering it visible spontaneously or from the unknown, but having from the beginning clear aims, constitutes a way to fight against the individualism and segregation in which we are immersed as inhabitants of this world.

Mapping is a practice aimed at lifting barriers and borders, and it allows our encounter in a territory of support and trust. Mapping is also a dynamic through which we build and strengthen the spread of new paradigms to understand the reality. And mapping is a way to produce territories, given that it is the establishment and renewal of spatial forms and of mechanisms to perceive time through which we nurture and project our actions.

## How to use this manual?

This manual is not to be used in just one way. By publishing this book we do not block practice nor experience. We believe that there is still much more to learn and to explore, which will be attained through your appropriations and drifts. The only thing that remains to be done for us is to encourage you to experiment in different spaces with the available resources, to let yourselves go with the flow of contingencies, and to adapt practices to strengthen situations of social and subjective cooperation giving way to, at the same time, processes of collective management of what is common to all.

**We welcome your feedback, contributions, suggestions, resources, and dynamics. You can send them to [iconoclasistas@gmail.com](mailto:iconoclasistas@gmail.com)**



1992 Acuerdos de Paz  
Comisión de la Verdad / Ley de Amnistía

1994 1ra elecciones (participa el FMLN)

1999 Eliminamos todo tipo de aborto de la constitución

2001 Dolarización del  
90-1997 Privatización

PENALIZACIÓN  
HOMOSEXUALIDAD

FEMINICIDIO

Guerra

1992 Acuerdos de Paz

1994 1ra elecciones (participa el FMLN)

1999 Eliminamos todo tipo de aborto de la constitución

2001 Dolarización del

90-1997 Privatización

PENALIZACIÓN HOMOSEXUALIDAD

FEMINICIDIO

COMISION DE LA VERDAD

Cumbre de los

TLC

COMISION DE LA VERDAD

Cumbre de los

1992 Acuerdos de Paz

1994 1ra elecciones (participa el FMLN)

1999 Eliminamos todo tipo de aborto de la constitución

2001 Dolarización del

90-1997 Privatización

PENALIZACIÓN HOMOSEXUALIDAD

FEMINICIDIO

Guerra

1992 Acuerdos de Paz

1994 1ra elecciones (participa el FMLN)

1999 Eliminamos todo tipo de aborto de la constitución

2001 Dolarización del

90-1997 Privatización

PENALIZACIÓN HOMOSEXUALIDAD

FEMINICIDIO

COMISION DE LA VERDAD

Cumbre de los

1992 Acuerdos de Paz

1994 1ra elecciones (participa el FMLN)

1999 Eliminamos todo tipo de aborto de la constitución

2001 Dolarización del

90-1997 Privatización

PENALIZACIÓN HOMOSEXUALIDAD

FEMINICIDIO

Guerra

1992 Acuerdos de Paz

1994 1ra elecciones (participa el FMLN)

1999 Eliminamos todo tipo de aborto de la constitución

2001 Dolarización del

90-1997 Privatización

PENALIZACIÓN HOMOSEXUALIDAD

FEMINICIDIO

COMISION DE LA VERDAD

Cumbre de los

1992 Acuerdos de Paz

1994 1ra elecciones (participa el FMLN)

1999 Eliminamos todo tipo de aborto de la constitución

2001 Dolarización del

90-1997 Privatización

PENALIZACIÓN HOMOSEXUALIDAD

FEMINICIDIO



# #2

## Territory and Mapping Workshops

What are mapping workshops. Reasons to work collectively with visual and graphic resources. How to organize a session and which tools to use. How to encourage questions to be raised which foster the emergence of reflections and alternatives at all times during the activity. Below we will answer some of these questions based on our experience from these years of collective mapping.

## #2 Territory and Mapping Workshops

### What is collective mapping?

Collective mapping is a creation process subverting the place of enunciation to challenge dominant narratives on territories. To do so we recur to everyday knowledge and experiences of participants. On a graphic and visual means the most acute problems of the territory are rendered visible identifying responsibilities, reflecting upon the links to other topics, and marking consequences. This viewpoint goes along with the process of remembering and marking experiences and areas of organization and transformation so as to spin a web of solidarity and affection.

While the hegemonic representation might become the starting point for workshops (when using, for example, a printed cadastral map with its predesigned borders), during the process of exchange of knowledge a critical look over the territory is built as a result of the various opinions and thoughts shared. Therefore the first representation is transformed due to the fact that hidden questions or those which are not simple to represent are now included.

If there is time during the workshops, maps can be drawn freehand. This becomes an opportunity to play with borders, senses, and shapes.

In each case, we must keep in mind that maps are only one tool among many others. When drawing maps is part of an organizational and collective process, this activity promotes the diagnoses and drawing up of participatory projects expected to be developed throughout the time.

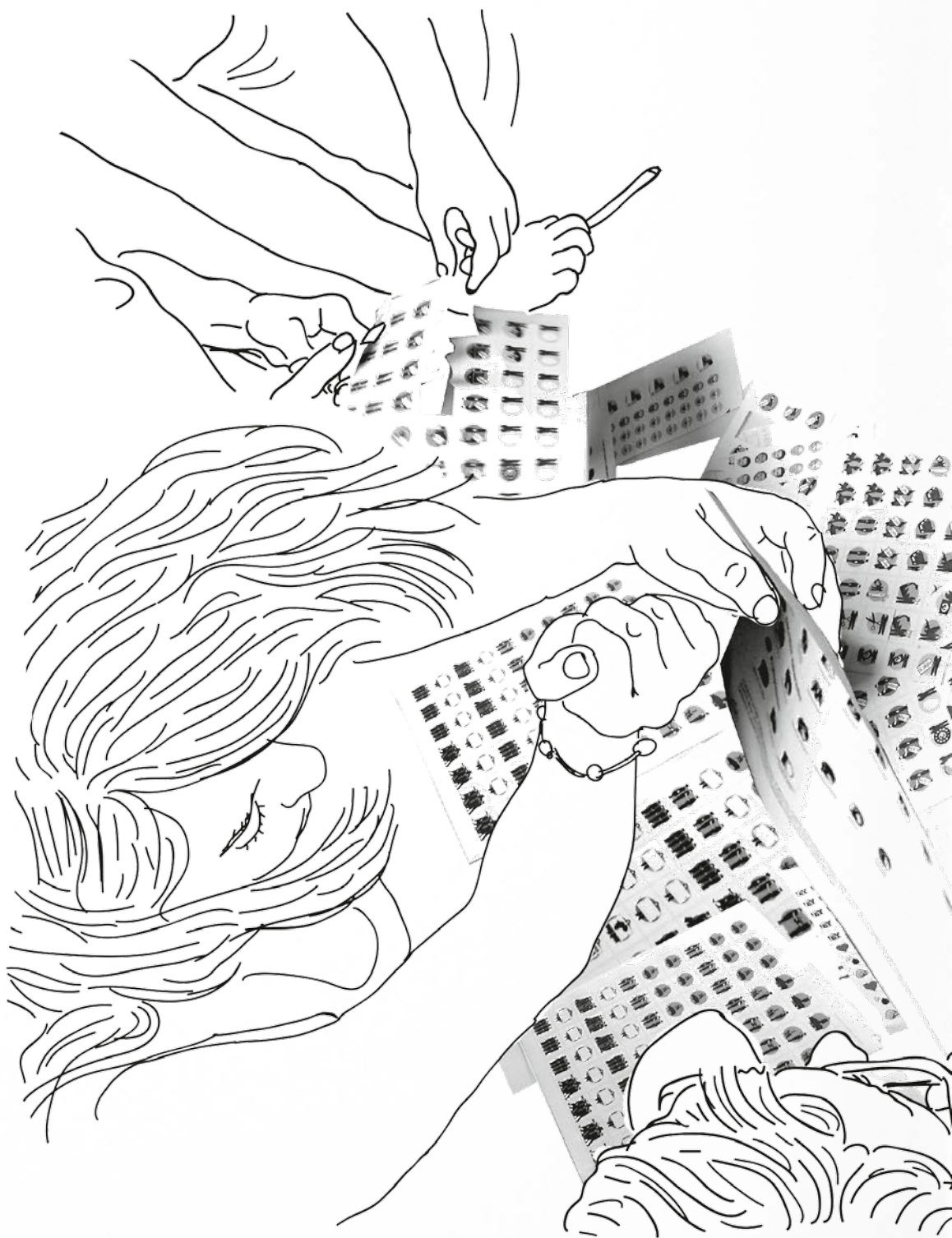



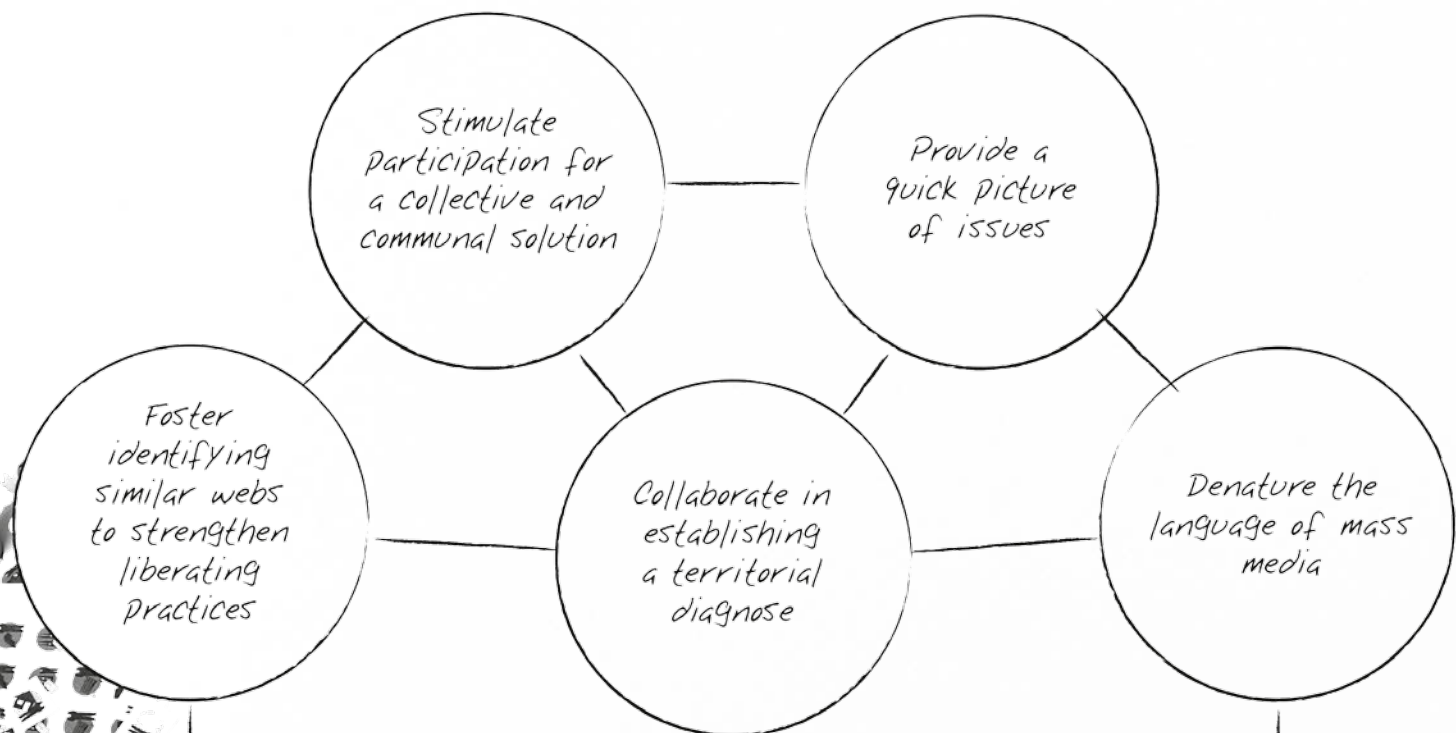

## Activities in workshops

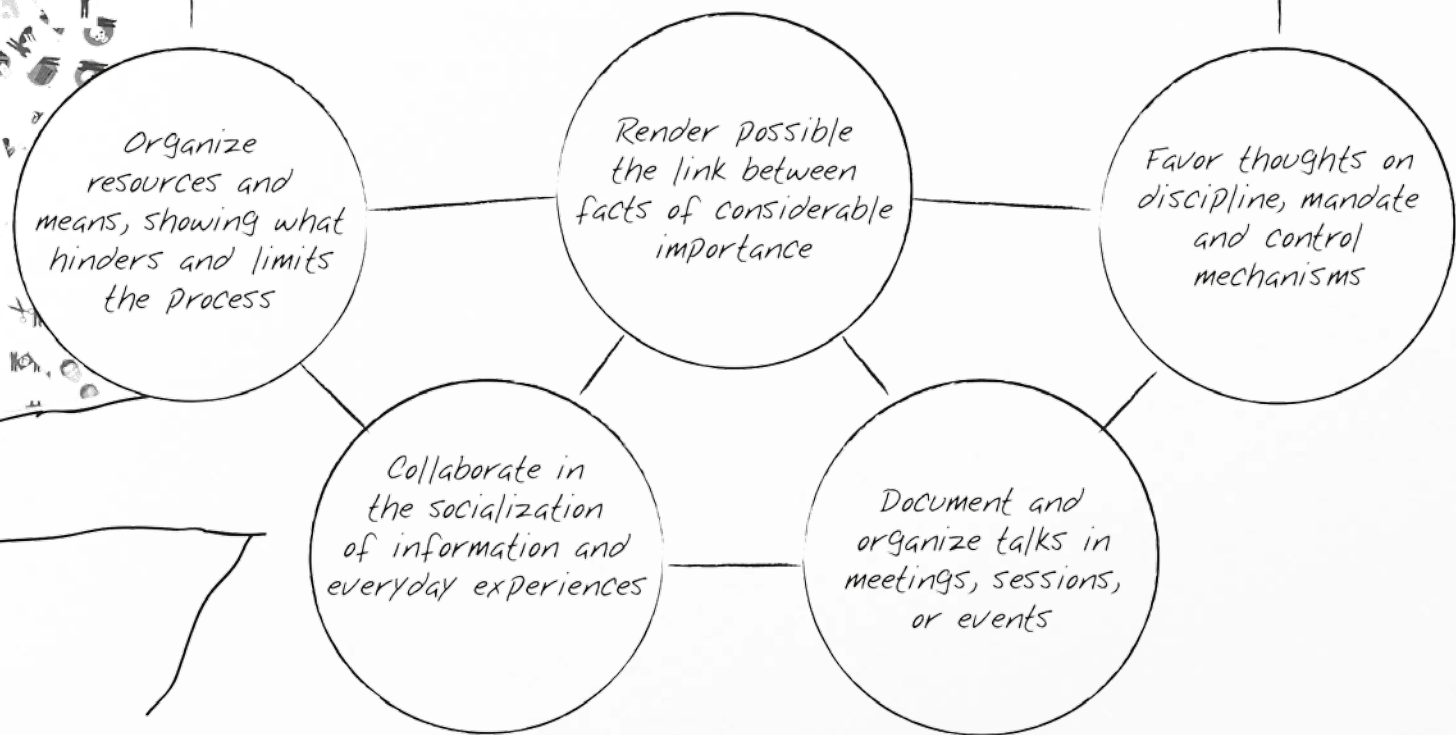

## #2 What to do after the workshop?



# #3

## Iconography for mapping

Using icons to mark the map vitalizes and strengthens the cartographic intervention providing a frame which works as a starting point for the debates in the workshop. In this section you can learn how to use them. You will also find iconographic series created for different occasions, which can be scanned, photocopied, and used.

### Die Unsichtbaren

Die folgenden Bereiche ersehen:  
- die für sich selbst  
- die für andere  
- die für die  
- die für die  
- die für die



**WICHTIG!**  
Beim Markieren bitte die folgenden Punkte berücksichtigen:  
- Gebiete, die davon betroffen sind, dass Leute aus  
- werden, damit ältere Gebäude erhalten werden können,  
- in folgenden Bereichen ersehen:  
- die für sich selbst  
- die für andere  
- die für die  
- die für die

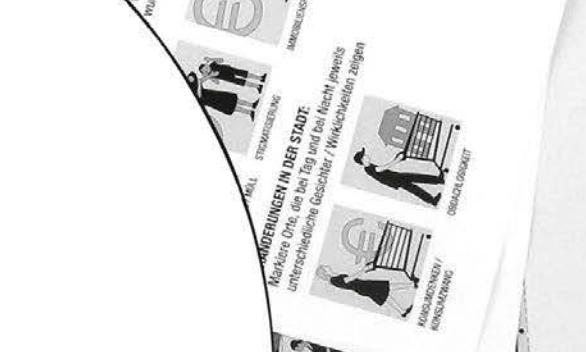

### #3 Iconography for mapping

## Use of icons, symbols, and images

Using visual resources and pictures in mappings stimulates the intervention of participants, fostering participation with the use of simple, metaphoric and symbolic images containing plenty of information.

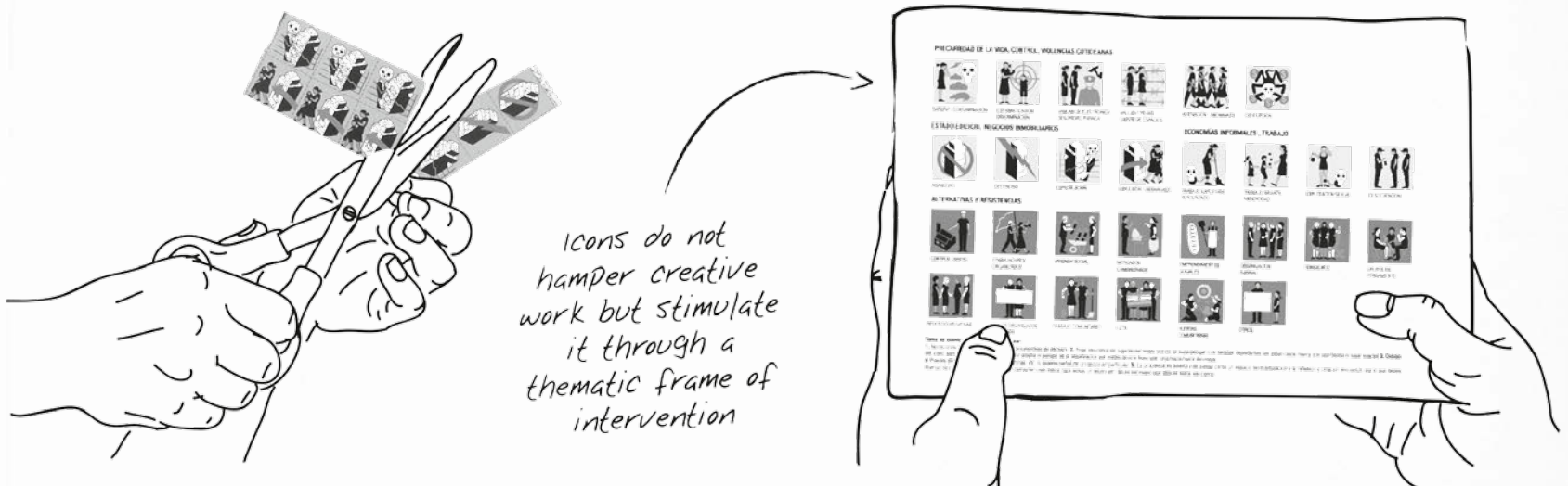

### Printing

Icons should be separated with dotted lines to make cutting them with scissors easier. They may be printed in common sheets of paper, and then stuck with glue, or on sticker paper.

### References

Each icon contains a specific reference which forms the thematic frame from which to intervene the map or the device. These references should be printed on a separate sheet of paper and should be displayed next to each icon. Display several copies on the working desk so that participants may consult them without any problems.

### Use

Icons should not be stuck over the point being marked (given that this makes the following systematization of information more difficult). Participants should draw a line and write on the margins, or write a number, and then briefly explain the topic marked adding more details (responsible individuals or institutions, causes, and consequences, etc.). Even if participants keep intervening creatively on the map, they should be encouraged to organize information to ease communication.



Son barrios que generalmente en sus inicios fueron de inversión, con población desplazada proveniente del Pacífico colombiano por lo tanto étnicamente es 60% de su población es afro. Geográficamente Aguablanca pertenece a la espalda de la ciudad. Existen programas de trabajo con comunidad vulnerable donde se trabaja con programas culturales, además de programas para mujeres, cultura de paz, población en situación de desplazamiento, redes de apoyo y redes de organización social.



✂ If not running out of time and the aim is to generate a process of creation of your own, pictures and icons may be drawn directly during the first sessions of the workshop. The previous task could be a territorial mapping from which topics to graphic stem.

## Combination

Various icons may be chosen to tell a story on a certain topic, adding therefore more information. To do so the margins of the maps may be used, including lengthier texts, the testimonies of participants that were gathered, or the organization of key information collected in the process.

Some colors to keep in mind:  
 yellow-danger; green-ecology;  
 red-organization; grey-  
 alienation; lavender-gender;  
 blue-suppression, etc.

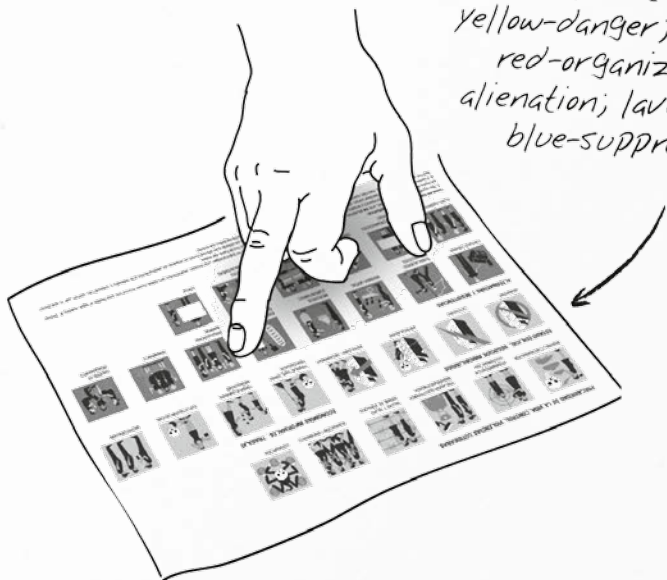

Images may be looked for in the web, clippings from newspapers and magazines may be included, or participants may be asked to bring photos.

## Color codes

Icons may be grouped by topics using the same background color (for example, organize using one color everything referred to curtailed fundamental rights: health, education, housing, etc.). In consequence posters may be quickly read by topics, making the diagnosis of the main issues easier.

## Each and every image counts

Organizers can add, apart from icons and pictograms, more complex images such as symbols, allegories, and everything that admits cross-reading. This also fosters participants to build metaphors, and acts as a trigger for topics overlooked before.

## #3 Iconography for mapping

### Different types of reference templates

Presenting images, symbols, and icons may be organized visually in different ways and according to the specific goals and the amount of participants. Below you can read the selection of our own templates from which to inspire yourselves and create your own.

#### Indicators

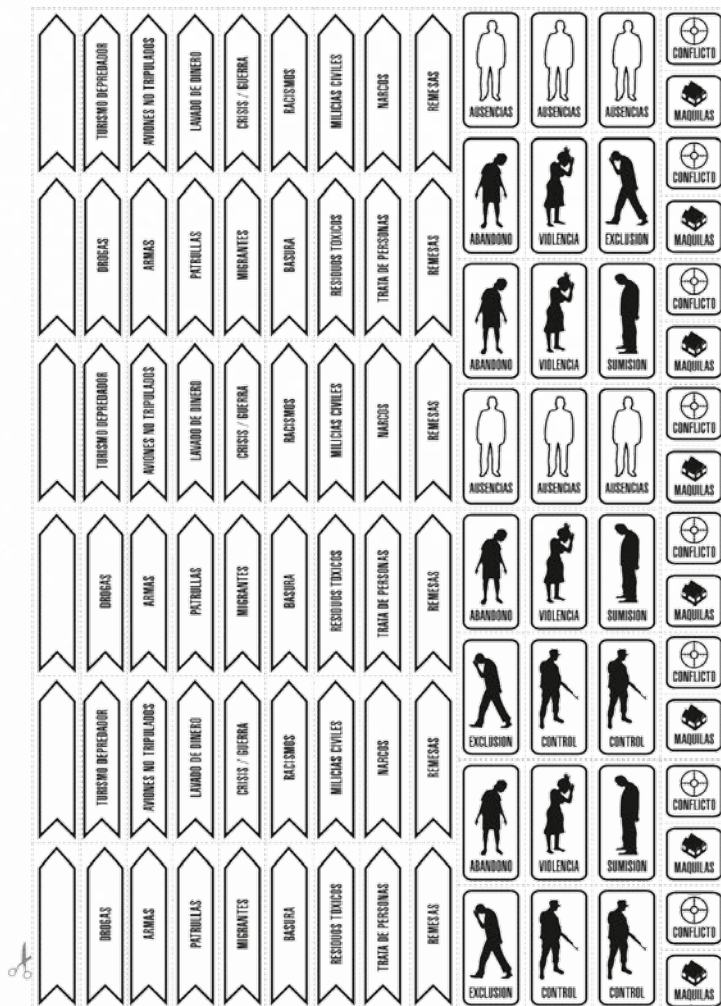

To mark areas, to demarcate borders in relation to the extent of certain issues, and to visualize flows of movements projecting potential scenarios and situations.

#### Posters



Images-sign with allegoric symbols of certain struggles and organizations to mark resistance processes including key facts, participants, achievements, and accomplishments.

## Referenced in detail

### Referencias problemáticas laborales del Vale do Ave y Peviden

	<b>Fábricas cerradas.</b> Nombre del establecimiento y fecha aproximada de cierre. Causas. Beneficiados. Consecuencias.		<b>Construcción.</b> Especulación inmobiliaria. Mano de obra inmigrante. Alto precio de las viviendas. Crisis habitacional.	<b>Industria</b>			
	<b>Desocupación.</b> Zonas donde la falta de trabajo es notoriamente alta. Responsables. Daminificados. Problemáticas asociadas.		<b>Zonas donde la precariedad y el abandono de la vida es notorio.</b> Escasas políticas públicas. Migración en busca de trabajo.		<b>Zonas de fábricas.</b> Parques industriales.		
	<b>Empresas que tercerizan y/o precarizan trabajo.</b> Nombre del establecimiento. Consecuencias de esta actividad.		<b>Fábricas, zonas donde se cambió la actividad industrial para la actividad de servicios.</b> Causas. Beneficiados. Consecuencias.	<b>Rubros por industria</b>			
	<b>Trabajo tercerizado en "casa talleres".</b> Enclaves puntuales donde prevalece de esta modalidad. Modalidades. Fortíles.		<b>Fábricas reabiertas.</b> Nombre del establecimiento y fecha aproximada de re-apertura. Responsables. Beneficiados.		Textiles/Ropa		
	<b>Flujos de la producción del trabajo tercerizado.</b> Bienes que se producen y sus destinos finales. Beneficiados.		<b>Fábricas nuevas.</b> Nombre del establecimiento y fecha aproximada de abertura. Responsables. Beneficiados.		Curtiembres		
	<b>Prohibición o trabas para la organización de los trabajadores.</b> Nombre del establecimiento que tenía esta postura.		<b>Zonas donde se percibe un nuevo investimento en la agricultura.</b> Emprendimientos agroecológicos. Mercados.		Calzado		
				<b>Rubros por servicio</b>		Cuchillería	
					Comercio		Metalurgia
					Turismo		Plásticos y cauchos
				<b>Organizaciones</b>		Centros de Formación e Investigación (universidad y centro tecnológico)	
					Sindicatos. Luchas. Revindicaciones. Manifestaciones.		
					Otras		

Templates created for particular activities where the list of topics and issues is previously defined with organizers and where the aim is to reconstruct a scenario recurring to the knowledge, practices, and ways to organize shared by participants.

We use various graphic resources and visual and creative tools to promote communicational, collective, and reflexive processes. After sharing information, knowledge, issues, and practices, interventions are projected and activated exceeding this sphere to reach the territory.

## With trigger questions

					<b>A MODO DE GUÍA:</b> En sus manos tienen un mapa y una serie de iconos con los cuales les proponemos señalar el territorio a partir de algunas preguntas disparadoras. Esta propuesta es abierta y se piensa como un espacio de estimulación a la reflexión y creación en común, por lo que ustedes pueden crear nuevos iconos, relevar temáticas no contempladas en primera instancia, inventar formas de señalización a partir de dibujos, textos breves, títulos, o demarcar zonas con puntos, rayas, etc. Asimismo, les proponemos indicar mediante flechas cómo se mueven los flujos (ya sea de capitales, de personas, de trabajo, etc.) que ustedes consideren interesantes a ser relevados por significativos, conflictivos, reveladores, etc. Al ser, en general aunque no únicamente, un mapa de conflictos y de resistencias lo interesante también es identificar a los protagonistas, nombrándolos junto a los iconos de referencia.
<b>BANCO PRIVADO</b>	<b>ESPECULACIÓN INMOBILIARIA</b>	<b>CONTRATOS PRECARIOS</b>	<b>ASALDIOS</b>	<b>ANTENAS CELULARES</b>	
					<b>PROBLEMÁTICAS URBANAS</b>
<b>PRO</b>	<b>GENÉTICA</b>	<b>DESALZOS</b>	<b>CONTROL</b>	<b>ASALTOS EN EL CARRETERO</b>	
					<b>PROBLEMÁTICAS RURALES</b>
<b>MIGRANTES</b>	<b>AGUAS CONTAMINADAS</b>	<b>SOJA</b>	<b>AGROPECUARIOS</b>	<b>MONOCULTIVO FORESTAL</b>	
					<b>PROBLEMAS AMBIENTALES</b>
<b>FUMIGACIONES</b>	<b>MINA A CIELO ABIERTO</b>	<b>PAPELERAS CERRADAS</b>	<b>TIERRAS EXTRÁÑERIZADAS</b>	<b>PETROLEO</b>	
					<b>PROBLEMAS SOCIALES</b>
<b>DEGRADACIÓN FORESTAL</b>	<b>DEGRADACIÓN PESQUERA</b>	<b>CONTAMINACIÓN</b>	<b>DEFORESTACIÓN</b>	<b>TERRAS</b>	
					<b>PROBLEMAS TERRITORIALES</b>
<b>FÁBRICAS RECUPERADAS</b>	<b>ASAMBLEAS</b>	<b>LUCHA COCIENTE</b>	<b>LUCHA CAMPESINA</b>	<b>RESISTENCIAS</b>	
					<b>PROBLEMAS SOCIALES</b>
<b>PUEBLOS ORIGINARIOS</b>	<b>CRIMINALIZACIÓN DE LA PROTESTA</b>	<b>UNIDAD DE PARTICIPACIÓN</b>	<b>TURISMO DEGRADADOR</b>	<b>TRATA DE PERSONAS</b>	

Similar to the aims sought by the above mentioned template, this one also includes a series of trigger questions which analyze even more deeply the details. The template offers a frame to debate and reflect upon, strengthening the one built when adding images. These should be relevant and not more than twelve.

Visual resources and tools should be created or brought some time before the workshop is carried out, showing on a graph the topics previously agreed on. The negative dimension (denunciation, for example) as well as the positive one (rendering visible the organization and the achievements) should be included.

### #3 Iconography for mapping

## Common goods and environment

To photocopy and to use

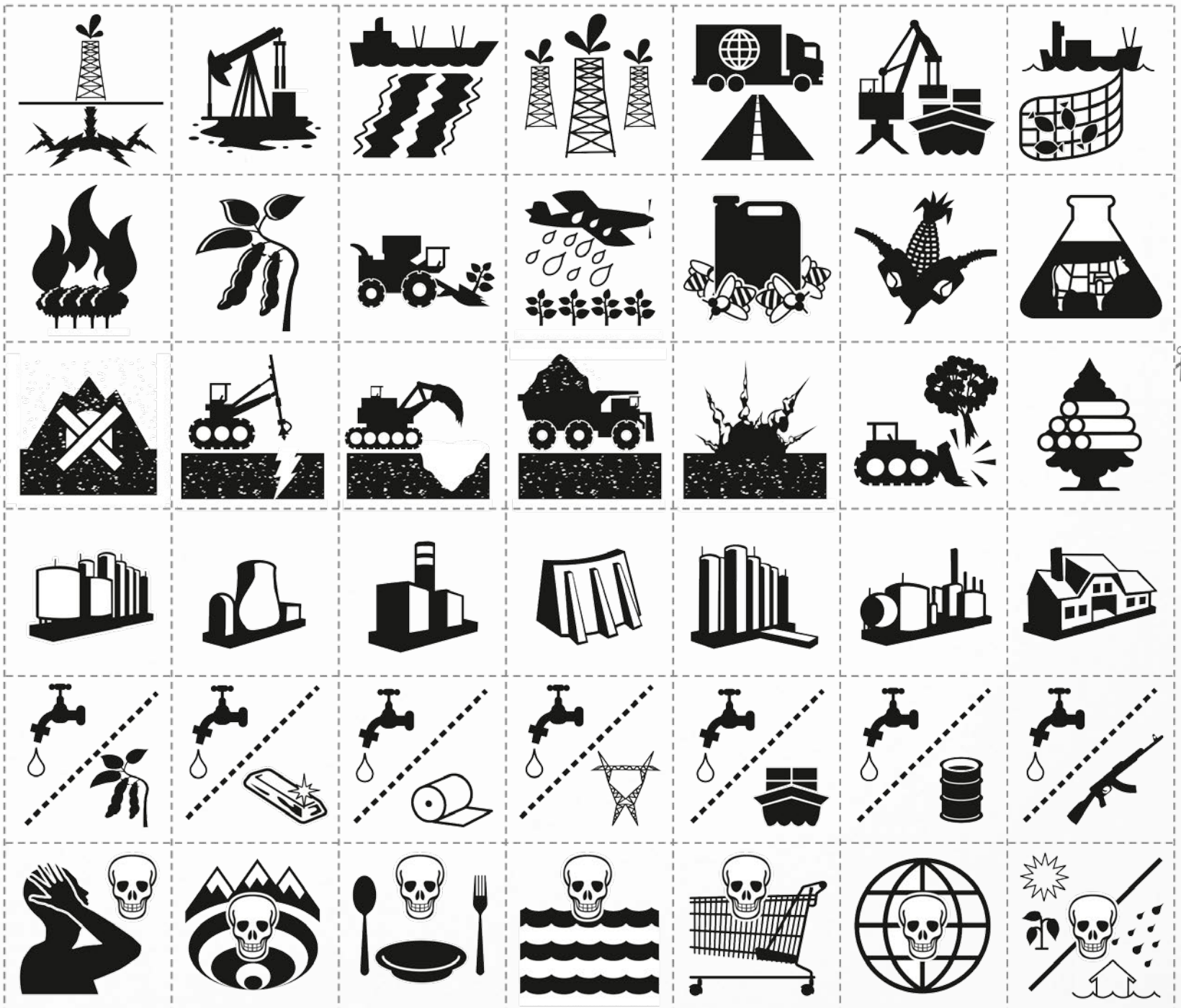



# Power, precarious situations and resistances

To photocopy and to use

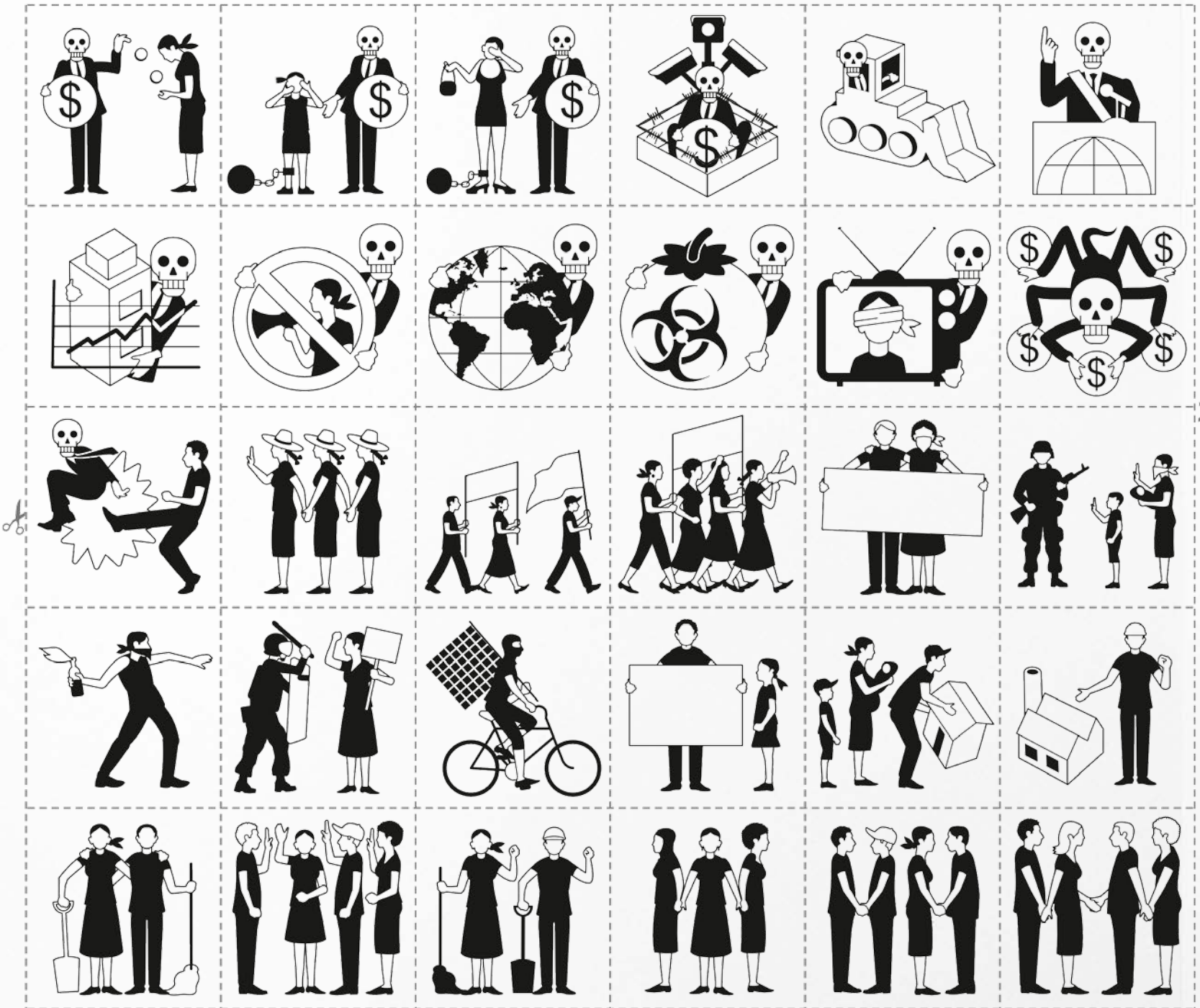



# #4

BY ICONOCLASISTAS AND TINTA LIMÓN

## Eleven theses for occasional cartographers

“A map is a diagram, i.e., an iconic sign that, even if it does not share the appearance of the object whose place is occupying, it copies in detail its internal links.” Paolo Virno

1



The map is a technology (besides being a trend) allowing something which is not divided by perceptions to be displayed or to appear through sight (as well as other senses), however, the map is built through them, through each one of those perceptions. In this way it resembles language: it does not preexist but as potential before the act of putting it into practice. In consequence, instead of speaking of maps, to speak of mapping is more adequate, mapping as an activity. Carrying no maps makes us weaker. The activity of mapping is an activity building senses, in its three meanings: it leaves a mark on sensitivity, it directs, and it fosters understanding.

2



The map is a *narrative strategy plus a tactic decision*. The map consists not only of information. Establishing mapping as a practice, as a critical tool, involves a collective task of reconstruction of the network of each situation, of identification (instead of totalization) of the complex nature of territories. Mapping also establishes bonds: when we listen to someone displaying on the map their trips, bets, aims, we are connected to a specific experience consisting of a way to inhabit the territory as a common as well as singular space.

3

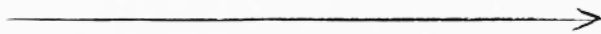

In Argentina, the map "Aquí viven genocidas" [Here live perpetrators of the genocide] became a milestone of a signaling system built as a social demand and stemming from injustice. In this case maps were tools and a slogan for the struggle at the same time. Other maps just mark the evil (gigantic companies' networks and expropriation networks as decisive agents of global capitalism). These represent two completely different mapping patterns. Other maps have also counterinsurgent uses: such as those built by NGOs along with indigenous communities in Brazil to demarcate their territories and the wealth they possessed, which were later on used by companies to expend and patent their resources and knowledge.

4

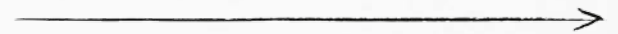

Recalling conflict and war is a resource to design projects on mapping neighborhoods, on industry and on the global market as well, and in this way technologies are developed: Google Maps, GPS, military technology applied to maps for users, companies using an activist language to sell digital platforms for digital mappings. And politicians offer neighbors to collaborate on the creation of maps "against insecurity" or "against drug trafficking." How could new social issues be mapped (without a *priori* images of how a territory should look)? How would mapping be like if a deep analysis is included, without pre-established icons or clear references to issues? The map is more difficult to design when facing a vague issue, without armies, or rather, with a radically non-traditional battlefield.

#### #4 Eleven theses for occasional cartographers

5

So we sustain that a new social dispute has erupted in the region stemming from the hegemonic presence of the financial capital in various territories (both rural and urban). Agribusiness, mega-extractivism, drug trade, all of these impose growing levels of violence as a method to subordinate the common to capitalist valuation. The use of armed gangs by businessmen, the complicity of the various police institutions, and the participation of judges and district attorneys as well as that of sectors of the political branch in this business web, these are all an everyday occurrence. Which kind of mapping is necessary to account for these new kinds of violence? How to understand the forms territorial dispute undertakes which run at new speeds?

9

A certain tension forces the icon because the icon is a very concrete and synthetic figure defining correctly what has been mapped or the conflict/subject to be mapped. Yet the icon cannot be just information or a figure that is always available. How to avoid clichés, accusations, and the fact of rendering visible a situation but without losing the force of synopsis? Predetermined icons exist, yet the icon is a pretext, an open trigger, and this is depicted in the remaining maps; not always the references of the icons or the information are read, the creative dimension and what was not previously thought is highlighted.

6

We need to create ways to render visible these new conflicts by way of an account that does not reduce itself to a police chronicle of the facts. Mapping is strengthened and invigorated when it is part of a network of experiences from different territories, when actions stem from collaboration and from collective thoughts aiming at resisting and taking care of each other.

10

Which is the capability of the action of mapping as public institution? This is something that awaits to be exploited and experimented. Especially when speaking of mapping subjects still not visible. When facing a new shape adopted by social disputes (exceeding the scheme social movements vs State), mapping means intertwining a collective intelligence capable of linking signs that, otherwise, would not appear as related between each other. Mapping involves coordinating a collective intelligence and wills devoted to understand the territory as novelty.

7



Maps are accounts of *new borders*. Those remade and redrawn after disputes to conquer space and resources and to produce the meanings corresponding to those new divisions and allocations. These are fluid borders, permanently tightened. These borders do not necessarily respond to institutional layouts or cadastral logics. Instead these borders are made with perceptions, they are spun with invisible yet powerful threads, which turn a neighborhood into an extremely complex area, housing labyrinths and dozens of interior borders, demarcated areas and superimposed spaces.

8

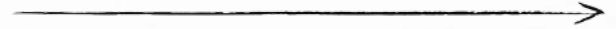

Mapping as synonym of cartography may become a strategy for the production of critical statements. Is this also linked to the new shapes conflict adopts? The question about the meaning of mapping is also the questions about the reasons for producing knowledge nowadays given that we understand mapping as a practice that produces knowledge. Which is the boundary between describing, rendering visible, and taking care of resistances? There is no doubt that the aim is not to put in danger clandestine situations, while the risk of "providing information to the enemy" always exists. The question is how to map the collective potential of work and, at the same time, take care and analyze deeply our own regime of situations rendered visible.

//



The dilemma between interpreting and transforming should be no longer an antithesis. Here and now, by way of the practice of mapping, a process of interpretation/ knowledge of the world is developed in concrete territories. This is carried out by combining everyday and popular knowledge (not specialized or expert knowledge) to create strategic tools aimed at transforming our realities. In this way, mapping-interpreting-transforming becomes a simultaneous task that is constantly in motion.



Since 2008 we have been setting up collaborative mapping workshops in Argentina, Europe, and Latin America, along with social, student, cultural, and artistic organizations. Throughout the years we have promoted the creation of collective viewpoints and landscapes on particular situations to display reflections over common territories. We believe the design and production of all this set of tools, through its reappropriation and use, evidences the creative and political potential of graphic and artistic devices. This is why we have decided to publish this manual: it has been conceived as a toolbox of open resources to promote territorial creative activism in the frame of a liberating process embodied by new practices, discourses, and subjectivities.



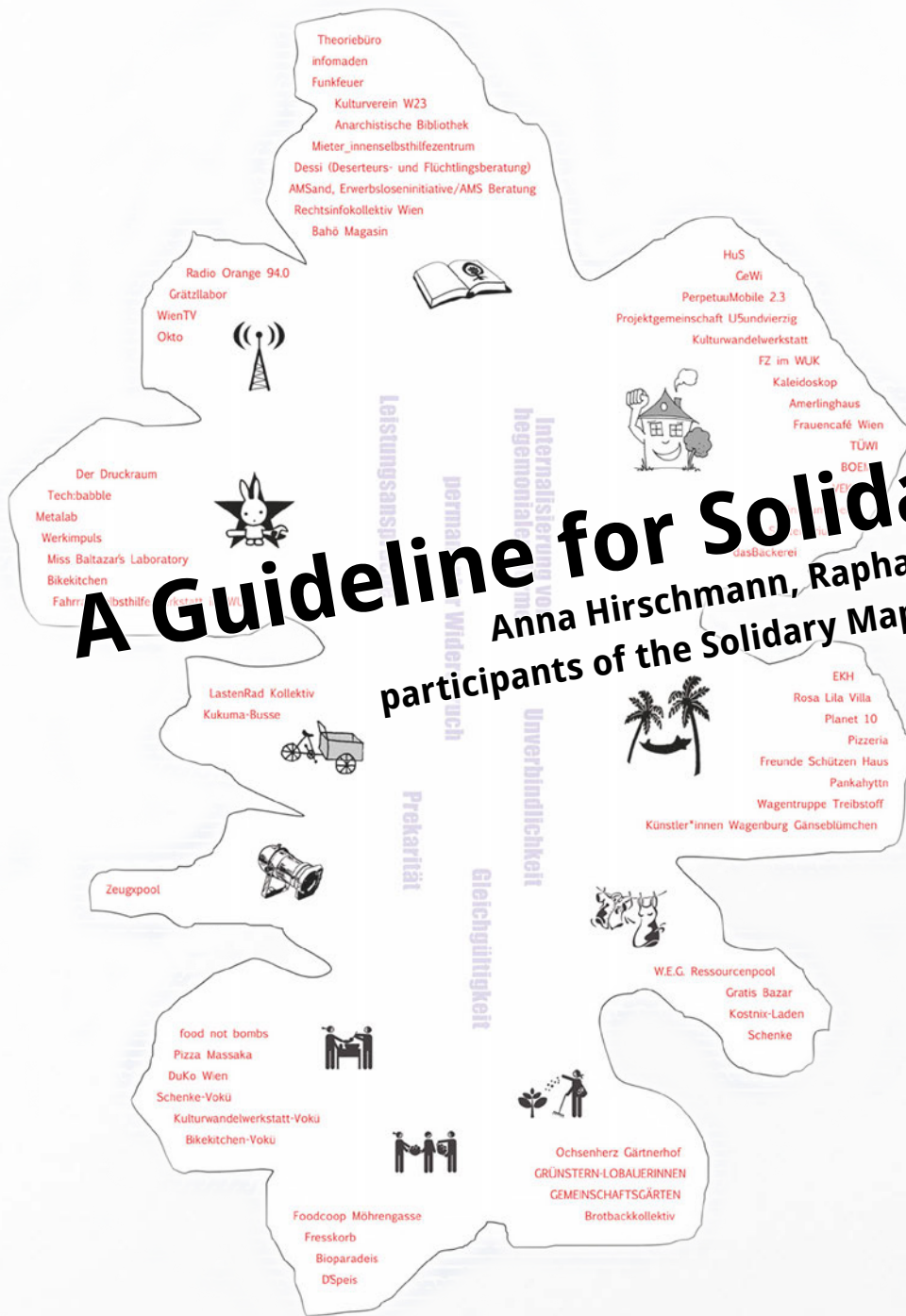

# A Guideline for Solidary Mapping

Anna Hirschmann, Raphael Kiczka, Florian Ledermann,  
 participants of the Solidary Mapping Workshop (Vienna, 2013)

## Introduction

Cartography, mapping, making maps. All of these often lead to fascination in solidary and emancipative contexts of all sorts. A map can be used as a tool in order to show the spreading of ideas. It can be used in order to visualize threats, conflicts or potentials. The relation between mappers on the one hand and mapped initiatives on the other hand is often not easy. Not everyone wants to be put on a map, and not always does everyone share the same perspective on the depicted reality.

This guideline should be understood as motivation to deal sensibly with possible problems that may arise within mapping projects, as well as with the relationships these problems may create in the context of their surroundings. The guideline can be understood as a basis for the specification of sensitive or difficult topics or the precise visualization of these topics as a result of such a process.

The suggestions in this guideline cannot and should not be understood as "rules". Initiatives decide autonomously about their mapping practice. Nevertheless, the guideline can help to better visualize and show the root of a problem, so that decisions can be made consciously and these decisions can also be reconstructed and understood by outsiders.

The approaches and questions in the guideline were created in the context of a workshop which was collectively organized at the congress that focused on solidary economy in Vienna in 2013 by the people from "Platz da!?" ([platzda.blogspot.eu](http://platzda.blogspot.eu)) and "Vivir Bien" (an online mapping project of solidary economy initiatives, active from 2009 to 2015).

The motivation for the workshop originated from experiences that were made in mapping projects, in which conflicts and pressures were revealed: While most of the mapped initiatives found the generated publicity helpful for their agenda and supported it, there were also those who found themselves being instrumentalized and limited in their self-definition and self-representation. They did not want to be linked with initiatives that did not share their political views and interests. The concrete disputes with these initiatives referred to general questions, which made it preferable to deliberately connect those who mapped and those who were being mapped in order to find a suitable way of dealing with these issues. The texts on the three topics that evolved are based on a mind map which was developed in the workshop.

## Topics

### I. "Respect Other People's Sovereignty of Self-Expression!"

Maps represent a selective view on the world. Content and circumstances are brought into relation. They delineate, and the single facts do not speak for themselves anymore. Maps are always based on analyses and views which can never conform with a general truth. At the same time, maps somehow seem reliable, objective and suggest they could show "everything that is important". The critique of the ideological or reality-constructing character of a hegemonic map also holds true for any alternative mapping!

It is exactly this character, that can turn an alternative map into a powerful, subversive and thought-provoking irritation. But all people involved in the mapping should be in agreement with this. Whoever maps groups or projects should ask these beforehand how they feel about being represented in the contexts these maps create.

Solidary mappings can furthermore generate a collective value of knowledge and dispute, if the first idea of mapping with all the represented individuals is opened for collective reflection and further developed. If the mapped "subjects" are at the same time involved in the production, this may lead to the mapping being more of a self-portrayal than an unwanted portrayal by somebody else. And this most likely leads to a better diffusion of the product and will probably make everyone involved happier. At the same time it is often sensible to consciously exclude certain actors. Grievances can rarely be mapped if the individuals responsible for these grievances are able to take part in the mapping process themselves. The objective of the map determines who should be mapping. As a tool for resistance, maps attack (hegemonic) interests, stories and perspectives. This does not require asking anyone for permission.

#### Needs of others

- They want to know that they are "being mapped".
- They want to know about the aim, the users and the statements of your map.
- They want to be able to decide which information about them is published where.
- They may want to remain anonymous.

#### Suggestions

- Let others know early in advance that you would like them to be represented on your map.
- Document the objective, potential users as well as the statement you want to make with your map.
- Let others participate in the way how and in which relation their project is presented on your map.
- Offer a direct option to correct data and give feedback.



## II. "Show a Colorful World!"

The historical evolution of maps is tightly connected to the development of national states and their instruments of governing and power. Maps have formed the representative basis for claiming borders, hierarchies and order, and they still do. If a general city street map shows highways as large and bold without depicting any bike lanes, we can clearly see the meaning and value of bicycles in comparison to cars within urban traffic. Generally, official and commercial maps tend to represent hegemonic power relations of the state and the market.

Opposing this is the reclaiming of a possible other world through emancipatory projects, and this is also how mapping projects can attempt a critical approach towards the visual basis of their maps. Maybe it would be helpful for the mapped topics not to cite the ruling power structures.

Euclidian geometrical space does not necessarily represent the best structure of an alternative perspective on the world. Associative mind maps, relational maps and networks, scribble maps or fictitious spaces all represent alternatives to the established, mathematically and technically structured views on the world.

### Needs of others

- Neither do they want to see their projects from a "governmental view" nor do they want to have to look at these kinds of maps over and over again.
- They want to autonomously interpret your maps without being instructed how to do so – they want to be able to find their way with your map but also to discover new things.

### Suggestions

- Design your map!
- Create your map in different scales and representations.
- Use alternatives to known map techniques and spatial conceptualizations, and use your imagination in order to find the format that is most useful for you. Sometimes the most useful map is the one that looks the least like it...

## III. "Create Commons!"

In the world of capitalism every single output, even media and information products, are by default subject to market and property logics. This means that, technically and legally speaking, your map or information collection can be viewed but not shared, modified or remixed by other people as long as you have not explicitly stated otherwise. This is contrasted by attempts such as those of the Commons movement or the Free and Open Source Software scene, whose goals it is to share and use resources as freely as possible.

Common tools for turning your map into a common resource are the licenses of Creative Commons. With the Creative Commons licenses you can easily define the precise ways in which other people can or cannot use your data or your map. In order to do so, it is enough to state that the work is protected by the chosen license and to link it to the license text. Other approaches, such as Public Domain or the "Do What The Fuck You Want To Public License" try to disconnect the work as much as legally possible from the copyright law.

### Needs of others

- They want to use public data in other contexts.
- They may want to carry on and establish new projects based on your work.
- They want to update existing and contribute new data.

### Suggestions

- Choose an open license for your map.
- Use other commons.
- Offer a direct option to give feedback as well as to correct data.

**GO,  
OCCASIONAL  
CARTOGRAPHER,  
GO!**



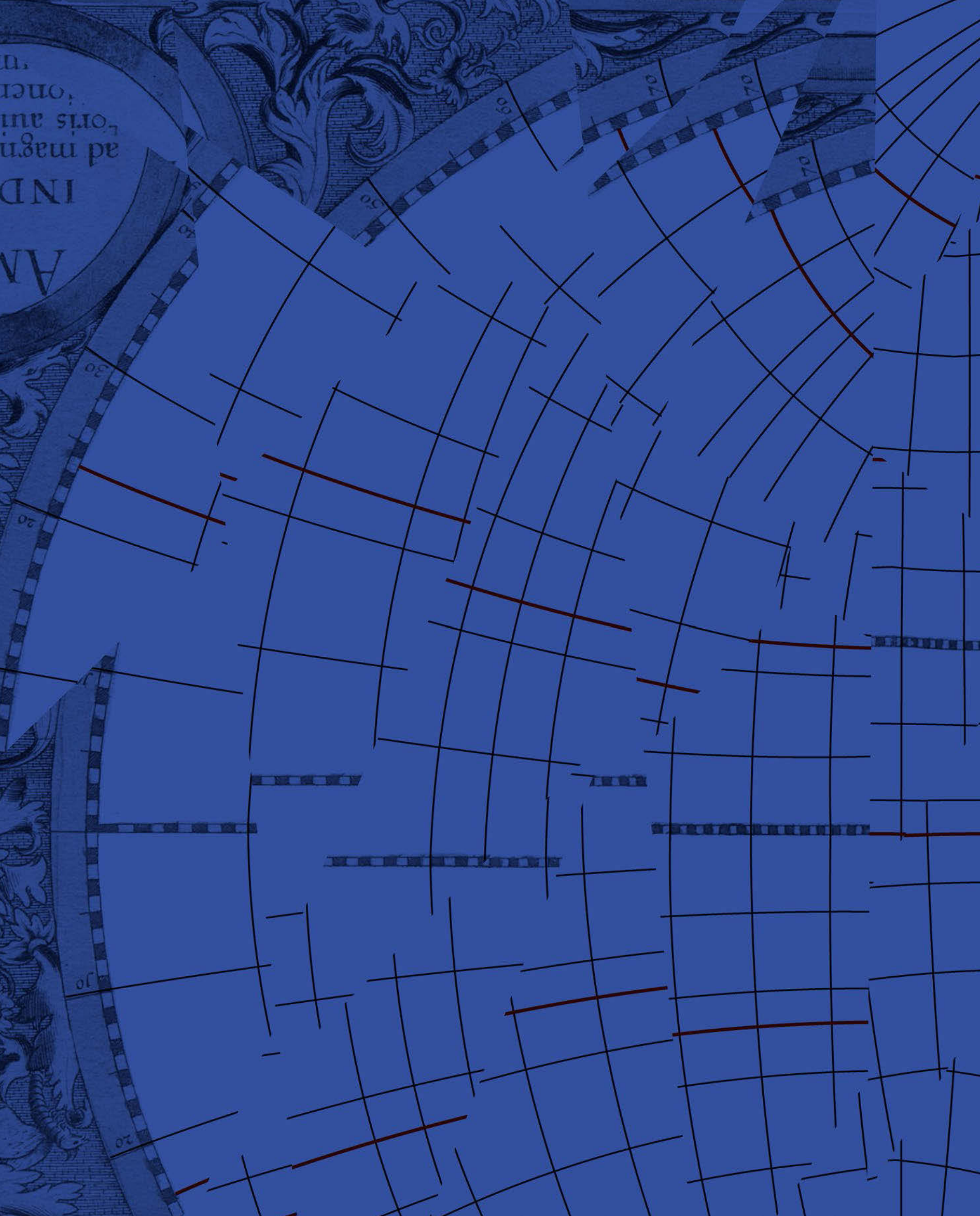

INDIA  
ad magnam partem

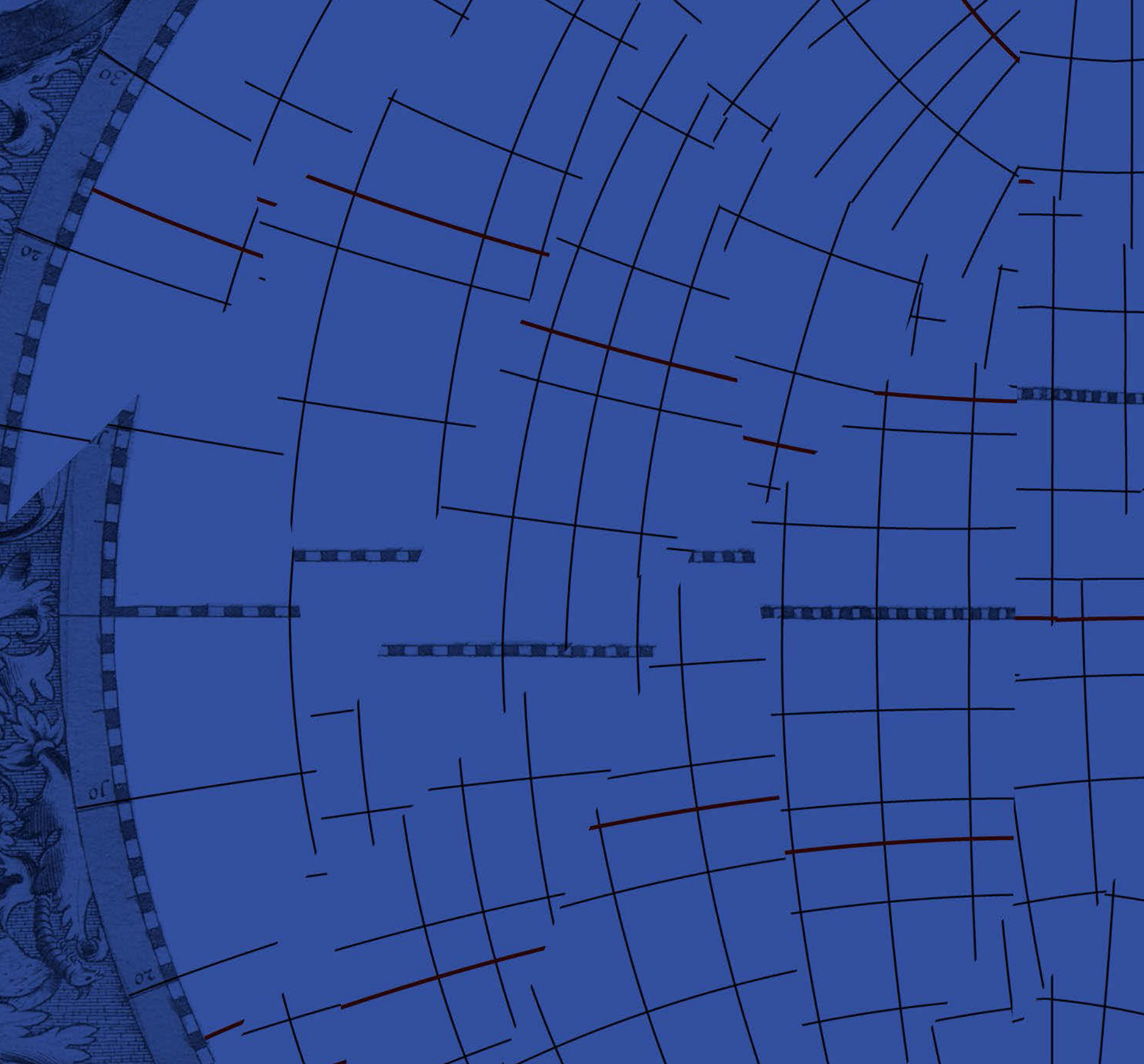



# Counter-Cartographies Create Visibility

# Counter-Mapping Militant Research'

Counter Cartographies Collective

Liz Mason-Deese, Craig Dalton, Nathan Swanson, Tim Stallmann, Maribel Casas-Cortes, Sebastian Cobarrubias

countercartographies.org

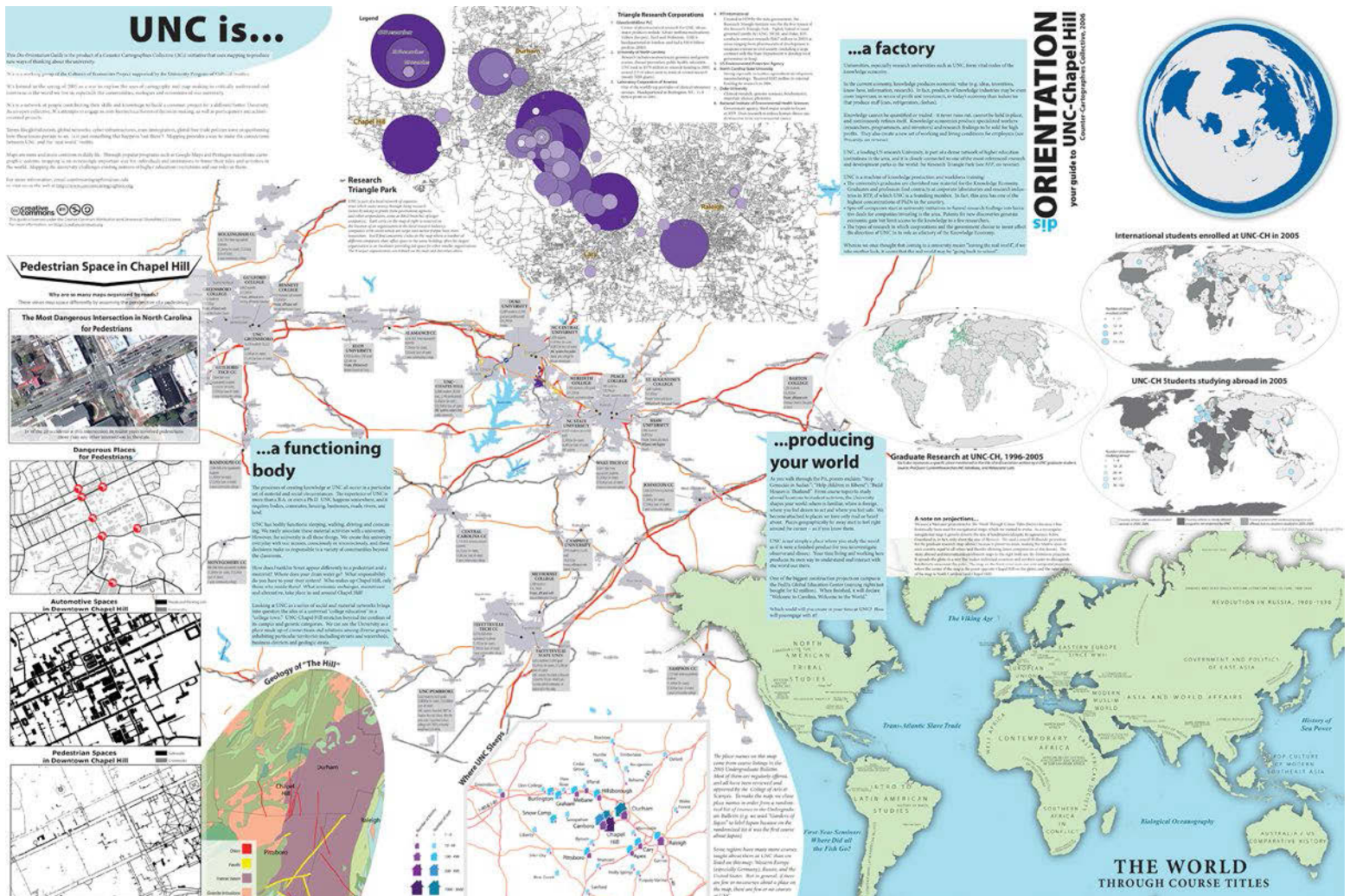

As a collective with diverse ties to the university factory – adjuncts, fellows, freelancers, indebted graduate students, assistant professors under review, unemployed PhDs and caregivers – how do we situate ourselves in relation to increasingly undemocratic and exploitative infrastructures of higher education? How can we confront everyday precarity<sup>2</sup> due to lack of access to housing, knowledge, healthcare, mobility, and employment? How can we organize to produce alternatives and reclaim life within and beyond the university?

As the Counter Cartographies Collective (3Cs), we map. Beginning with our own situations, we create a mapping of and for political change, combining militant research with counter-mapping to produce alternative ways of visualizing and inhabiting our university and world. Our mapping is grounded in the tradition of autonomous politics: emphasizing the power and creativity of labor over that of capital, realizing the need to go beyond state-centered activism and work for political change from below, and recognizing the centrality of struggles around knowledge production in the current political-economic context. As militant research, autonomous mapping simultaneously produces analyses and political interventions, helping us to understand and challenge the changing spaces of oppression where production/reproduction are geographically diffuse.

We use autonomous cartography to analyze and intervene in processes at the University of North Carolina at Chapel Hill and, through collaboration, at other institutions around the world. This mapping prompts critical and reflexive self-organizing cognizant of the many forms of labor at the university and the university's role in the broader economy and social fabric. 3Cs' autonomous cartography creates non-hierarchical relationships within our collective as well as open identities and unexpected alliances as people interact with our maps and begin to enact their university in new ways.

## A University Drift

3Cs first formed not with a set mission or clear goals, but as an affinity group with common interests and methodological commitments. We were frustrated by talk among activist scholars on campus limited to their own field research sites. Much of this work attempts to contest divisions between academia and activism, yet reinforces the divide by geographically separating intellectual production within the university from activism outside. We wanted to do something politically and intellectually relevant to all of us instead. An opportunity arose when our university administration selectively canceled the Labor Day holiday, giving the administration the day off, but not students, educators or researchers. How to protest? Where to protest? Was this a labor protest? How could we, through understanding this situation, begin to enact a different university?

For us, these questions resonated closely with those of Precarias a la Deriva (Precarious Women Adrift), a self-identified militant research project based in Madrid, who developed geographic interventions using feminist drifts and picket-surveys. When major labor unions in Spain called a general strike in 2002, several women realized they were not in a position to participate. How could temp workers, the self-employed, workers on per-hour con-

tracts, and domestic workers strike? Who would even notice? To address these questions, Precarias developed a technique of feminist drifting. The drifts visited sites of precarious labor where workers were unable to participate in the general strike and asked a provocative question: What is your strike? Or what does it mean to go on strike in your situation? (Precarias a la Deriva, 2006). Asking this question served multiple purposes. Firstly, it stopped the production process for a few minutes: a mini-strike. Secondly, it investigated the conditions of work/life in the contemporary economy. Thirdly, it established connections among a disparate group of workers for future organizing.

In each drift, a different precaria would lead the group of drifters through their everyday trajectory, discussing their lives and answering questions along the way. As opposed to the Situationists' use of the derivation to understand the literal structure of the city, the Precarias' drift is a directed itinerary through the specific conditions of their personal everyday lives. Drifting was useful for exploring the spatial practices of precarious workers, who are often not confined to a singular or stationary workplace, allowing them to find intersection points between distinct and atomized itineraries in urban space, pointing to hierarchies and differences, as well as commonalities among different forms of labor.

Inspired by Precarias a la Deriva's query, "what is your strike?", we began our own drift on Labor Day. We set up at the social hub of campus with chalkboards, signs, paper and recording devices. We asked passers-by to talk about their own work by drawing maps and participating in interviews. We drifted through campus, visiting working classrooms and closed-for-the-holiday offices, mapping where work was or was not taking place.

The drift proved useful in its dual nature as research and spatial intervention. It provoked multiple reactions: confusing reporters as to whether it was "research" or a "protest", and encouraging students and faculty to reflect on their own labor. It was a way to explore spaces and inhabit them differently. While our suburban college town is very different from Madrid, we found many similarities with the precarias' experiences. Many people we talked to worked on temporary contracts with little job security, some worked multiple jobs or part-time with no fixed hours and low pay. As our research continued, we found an expensive and growing administration separated from the concerns of university workers. We found a push for privately funded research in competition for prestige. We found infrastructure designed to blur the lines between work and leisure to spark "entrepreneurship", a specific subjectivity of the knowledge worker (Holmes, 2007).

## The University Factory

We began to understand how our own daily activities in the university – our research, writing, volunteering, learning, and teaching – were work, productive labor enmeshed in the relationships of surplus and management of post-Fordist capitalism. Using concepts such as the social factory and general intellect, we were able to recognize the role of collective social knowledge in production and how that production occurs throughout the social field, involving diverse forms of labor. Theorists of cognitive capitalism, the commercialization of general intellect, recognize the university as a key site of value production and class struggle

(Edu-Factory Collective, 2008), since immaterial, affective, and intellectual labor are increasingly important for producing value in the post-Fordist system (Lazzarato, 1996; Hardt & Negri, 2000). Even student leisure time can produce value within the social factory of the university by adding to the university brand (Bousquet, 2008). These open definitions of labor allowed us to recenter our understanding of how the university works based on women's unpaid domestic labor, the production of culture and language we all participate in, and work that explicitly produces knowledge. However, the lack of a common space for immaterial labor makes it difficult for these workers to organize. Our solution, counter-mapping, is a pragmatic response in that it can identify the sites (physical, cultural and social) where immaterial labor takes place and create a common space of encounter, bringing people together to share experiences and analyses, generating alternative ways of being and acting in the university.

### Maps and Militant Research

Counter-mapping springs from arguments in geography that emphasize the situated, productive role of power in mapping and related geographic knowledge production (Wood, 2010; Crampton, 2010). Emphasizing the productivity of power opens a multiplicity of cartographic power-knowledges and subject positions outside traditional institutional cartography – examples include public participatory GIS, art maps, and counter-mapping. Nancy Peluso coined the term "counter-mapping" to geography journals to describe mapping indigenous land claims (1995). But others, such as the Surrealists, the Situationists, Bunge's geographical expeditions, responses to the plight of migrants to Europe, and recent conservation efforts all employ forms of counter-mapping (Wood, 2010; Bunge, 1971; Harris & Hazen, 2005; Holmes, 2003; Cobarrubias, 2009; Cobarrubias & Pickles, 2008).

Doing counter-mapping means navigating a set of weighty questions: How do we build conversations and solidarity through mapping, not authoritative cartographers and maps? What can be shown and what should remain obscured? How do we avoid co-optation by capitalist, state or colonialist discourses? 3Cs' approach to these questions employs practices and theories of autonomous politics and militant research to engage in counter-mapping from our own situations.

We call this approach autonomous cartography. It builds on the insights of counter-mapping by using practices of militant research and ideas of autonomous politics. Pickles calls on mappers to engage in many different kinds of mapping to create new alternative spaces and worlds, "and, and, and" (Deleuze & Guattari, 1987; Pickles, 2003; Holmes, 2003; Cobarrubias, 2009). 3Cs' practice intends to create new (political-geographic) possibilities and other (political-geographic) realities rather than (re)presenting existing geographies, drawing on Deleuze's (1988) critique of representation and developing our own form of militant research<sup>3</sup>, inspired by Precarias a la Deriva and Colectivo Situaciones.

Militant research – research that produces knowledge for social struggle and is itself a form of political intervention – has multiple, situated approaches. Our first engagement with the term comes from the Buenos Aires-based Colectivo Situaciones. Eschewing objectivity and/or critical distance, their multiple re-



search initiatives attempt to break down the subject-object divide, describing the relationship between the researcher and researched as one of love or friendship. Both parties actively participate in this relationship and are transformed in the process (Colectivo Situaciones & MTD de Solano, 2002). Knowledge production affects and modifies the bodies and subjectivities of the participants and is an essential part of any political practice. Situaciones collaborates with social movements in conducting collective investigations as a form of political struggle, recognizing that "collective thought generates common practice" (Malo, 2007: 35).



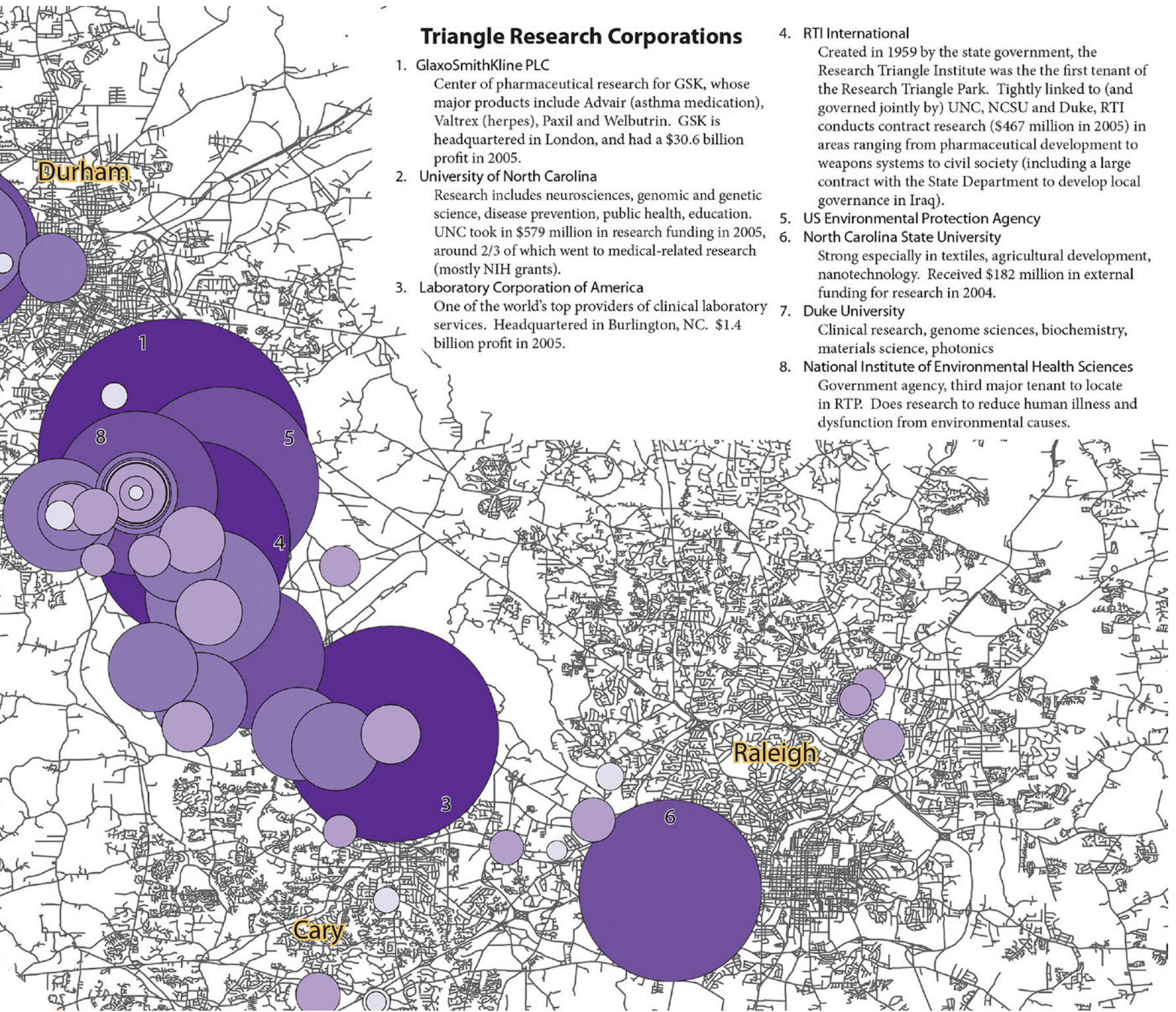

## Triangle Research Corporations

1. **GlaxoSmithKline PLC**  
Center of pharmaceutical research for GSK, whose major products include Advair (asthma medication), Valtrex (herpes), Paxil and Welbutrin. GSK is headquartered in London, and had a \$30.6 billion profit in 2005.
2. **University of North Carolina**  
Research includes neurosciences, genomic and genetic science, disease prevention, public health, education. UNC took in \$579 million in research funding in 2005, around 2/3 of which went to medical-related research (mostly NIH grants).
3. **Laboratory Corporation of America**  
One of the world's top providers of clinical laboratory services. Headquartered in Burlington, NC. \$1.4 billion profit in 2005.
4. **RTI International**  
Created in 1959 by the state government, the Research Triangle Institute was the the first tenant of the Research Triangle Park. Tightly linked to (and governed jointly by) UNC, NCSU and Duke, RTI conducts contract research (\$467 million in 2005) in areas ranging from pharmaceutical development to weapons systems to civil society (including a large contract with the State Department to develop local governance in Iraq).
5. **US Environmental Protection Agency**
6. **North Carolina State University**  
Strong especially in textiles, agricultural development, nanotechnology. Received \$182 million in external funding for research in 2004.
7. **Duke University**  
Clinical research, genome sciences, biochemistry, materials science, photonics
8. **National Institute of Environmental Health Sciences**  
Government agency, third major tenant to locate in RTP. Does research to reduce human illness and dysfunction from environmental causes.

Not only is Colectivo Situaciones' militant research an alternative to traditional academic research, it is also different from conventional forms of activism. It is a manner of doing politics that takes nothing for granted and leaves no room for the easy answers of dogmatic ideologies or party lines. It emphasizes the situatedness of any political struggle, making universal, pre-known answers impossible and calling for continual investigation and questioning (Colectivo Situaciones, 2007).

3Cs' combination of counter-mapping with militant research renders autonomous cartography quite productive and evocative.

We do not disallow or discount other forms of mapping or militant research. Instead, we apply the proliferating logic of "and, and, and" to disseminate and acknowledge multiple new ways of mapping, producing cartographies explicitly in the grammar of struggle.

### disOrientation Guide

Our mapping collaboration blossomed into the best known 3Cs project to date, disOrientations: (y)our guide to UNC-Chapel Hill. The disOrientation Guide multiplies understandings of the

## Pedestrian Space in Chapel Hill

Why are so many maps organized by roads?

These views map space differently by assuming the perspective of a pedestrian.

### The Most Dangerous Intersection in North Carolina for Pedestrians



14 of the 26 accidents at this intersection in recent years involved pedestrians, more than any other intersection in the state.

### Dangerous Places for Pedestrians



### Automotive Spaces in Downtown Chapel Hill

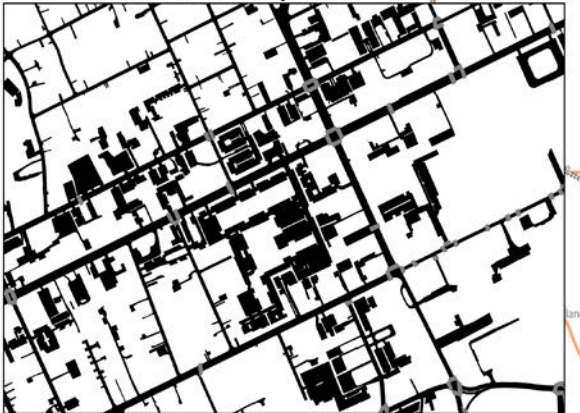

### Pedestrian Spaces in Downtown Chapel Hill



University of North Carolina at Chapel Hill to complicate notions of the university as an aloof ivory tower, detached from the so-called real world. We mapped UNC-Chapel Hill as a multiplicity of processes with many entrances and exits, thoroughly integrated with local and global economies of knowledge production.

The visual chaos on first viewing is an intentional attempt to explode any simple, singular or territorial notion of the university. A close look reveals a framework, but even that is not discrete. The margins of each theme conceptually and graphically merge into others. Three general concepts, corresponding to different theoretical perspectives, organize the front of the guide. The reverse side serves as a response to re-orient the viewer.

**UNC is a factory.** Guided by a Marxist analysis, this concept plots the university within regional and global relations of knowledge production and labor. Maps show the dense network of higher education and corporate knowledge production in which UNC-CH is located. Corporations at the Research Triangle Park profit from the results of publically funded and cooperatively produced knowledge in the university, as well as the labor of university workers. This regional economic growth regime shapes the university. Students not only learn the course material, but also to be researchers, programmers, inventors, and entrepreneurs, becoming accustomed to precarious living and working conditions in order to fuel the creative economy (Moten & Harney, 2004).

**UNC is a functioning body.** Guided by Deleuzian ideas, this concept highlights how the university is materially embodied. Knowledge production and immaterial labor cannot be composed purely of abstraction. The university is composed of people that eat, sleep, travel, use natural resources, and profoundly affect the environment they inhabit. The maps in this section investigate the practices and networks that literally make up the university. Maps include where faculty and staff sleep (live) and how spaces, such as tiny pedestrian areas and wide automotive roads, are defined in and around the university. Different appropriations of space affect how we envision and occupy the university.

**UNC is producing your world.** Guided by Foucault's analysis of the productive interplay of power and knowledge, this portion maps UNC-CH's role in the production of (geographic) subjects as global citizens in a particular discourse about the world (Foucault, 1995). Maps show where UNC-CH students study abroad, where foreign students come from, and what parts of the world are studied in undergraduate courses. From these maps, we see that UNC-CH is highly focused on the United States and Europe. Some places, such as popular study abroad destinations Sevilla and London, appear large in the university's worldview, while others do not appear at all.

**Reorientations.** The reverse side of the disOrientation Guide further multiplies UNC-CH through a people's history of the university and a directory of local progressive organizations. A local economies map draws on Gibson-Graham's writings on local, diverse economies (1996, 2006). From cooperatively owned and managed bookstores and grocery stores to a really really free market where items and services are freely shared and exchanged,

Chapel Hill is already awash with anti / non-capitalist practices. This side of the disOrientation Guide serves as a useful guide for newcomers to the area. It also illustrates that many other universities are not only possible, but are already being enacted.

Through these concepts, the disOrientation Guide brings together mapping and militant research in a visual, cartographic product. Nonetheless, this autonomous cartography is not completely encapsulated on paper: The importance of our work extends beyond the map to the process of making and sharing the map. Trust among friends created an open atmosphere for collaborative map-making and theoretical heavy-lifting. Not everyone entered the process with the same background or expertise, yet we avoided assigning permanent roles. In fact, the uneven distribution of expertise motivated us to socialize that knowledge, teaching each other skills and techniques throughout the process. For example, the one of us with basic cartographic training did not do all the graphic design but rather took the opportunity to share cartographic methods with other members of the collective. Such a collaborative process is often contentious and difficult to sustain. Positive, flexible attitudes, food (especially pizza) and regular breaks are imperative to keep the process moving forward.

At each meeting, members shared new map ideas, research, and cartographic design drafts. Early in this process, we decided on the general concept of the guide but not on the internal framework. Through our continuing conversations and mapping, our theoretical analysis and practical understanding of the university began to emerge. The framework of the guide came together in a single marathon meeting that set up the three-concept front side. Initially distributed in undergraduate and graduate classes, the guide prompted interesting discussions about students' labor, faculty salaries and the university's relations with other social and economic institutions.

We were surprised to find that the disOrientation Guide also had value for other activist groups, even those outside Chapel Hill. The relevance beyond UNC-CH allows for greater conversations and collaboration through mapping with other groups. These are processes of sharing and creating knowledge, forming relationships and producing new subjectivities. We continue to distribute disOrientation Guides for free through student and activist networks and our website.

## disOrientations<sup>2</sup>

While distributing the first guide, 3Cs continued to conduct research and map knowledge production. Out of this work, we produced other graphic products, including a comic book about UNC-CH's drive to build a research campus, a zine about budget cuts and, in 2009, a second disOrientation Guide (see article page 26).<sup>4</sup> disOrientations<sup>2</sup> focuses on UNC-CH within the mutually related crises of the university and the economy, delving more deeply into the ways precarity, migration and global resistance struggles were playing out on university campuses at the time.

Much like the first disOrientation Guide, the idea of disOrientations<sup>2</sup> is to explode the notion that our university and others have a simple, singular problem, a budget shortfall. disOrientations<sup>2</sup> includes maps and graphics of the game of university rankings, the role of migrants in knowledge production, the precarious

labor conditions of many university employees and struggles for alternative higher education around the world. Following the first guide, disOrientations<sup>2</sup> plots multiple processes and existing equitable alternatives to current university struggles. Compared to the first guide, it has a stronger focus on subjectivity and how we were individually and collectively navigating the crevasses of the university in crisis.

With several international participants in the collective, an important analytical element in disOrientations<sup>2</sup> is the question of mapping how UNC-CH is part of the broader border regime. We map how the university functions as a border with a flow-chart of rules, restrictions and regulations related to student visas, as well as with a map of student migration flows. We also map how the university produces precarity, documenting the uneven implementation of austerity measures. We map the effects of rankings and competition, as well as a global wave of protest at university campuses that inspired our efforts. The second disOrientations Guide is also an explicit attempt to generate new networks and alliances with struggles in different places as part of our political project. Some of the data for the guide was even crowd-sourced via those same networks.

## Counter/Mapping QMary

As our maps and practices of counter-mapping and militant research traveled, a few of us also traveled to London to participate in a project counter-mapping Queen Mary University.<sup>5</sup> A set of international students with different theoretical backgrounds, personal experiences, skill sets and familiarity with mapping, coalesced around this project. The resulting map served as a direct intervention in a specific political moment, bringing together the issues of migration and student struggles, both important political issues at the time, but lacking dialogue between activists dedicated to each issue.

The front side maps the flows of international students into the UK, depicting the political economy of migration as well as the hierarchical relationships created in a university increasingly defined by rankings and the "research excellence framework." Filters depict the borders, showing that the border lets some people in while keeping others out, transforming everyone in the process. The map also shows sites of resistance, giving symbolic visibility to the burgeoning student movement. The other side attempts to delve deeper into the subjective aspects of migration through a board game that allows players to experience the journey of students from different origins studying in London. The game was designed after interviews and conversations with international students, inside the collective and out, allowing us to incorporate their experiences – both their suffering and constant forms of resistance – into the game and creating stronger relationships between those students in the process.

Making the map, each participant contributed according to their skills: drawing icons or sea monsters, using mapping or design software, researching migration laws and data, building a theoretical framework. Yet we also learned from one another, taking care to socialize those skills and know-hows. As part of the research process, we organized a public seminar called "What is the university?" and a mapping workshop as well as a collective re-

search drift through campus. These events and actions helped us to expand the mapping process beyond the collective to include the larger university and activist communities.

## Conclusions

Our experiences with autonomous cartography illustrate how mapping can function as a form of militant research, producing novel knowledges and subjectivities while also investigating and instigating political change. For 3Cs, this means not only producing empowering maps but also creating alternative forms of social organization within and beyond the collective. These experiences highlight the importance of collaboration and trust as well as careful consideration of the social context and ethics of mapping. This work is premised on the idea that geographic knowledge and spatial creativity are produced by movements and people affected by different forms of dispossession and ready for dissent.

Around the world, spaces of resistance and autonomous knowledge production are emerging as the rhetoric of crisis and budget cuts are being used to further privatize universities and enclose knowledge. In this context, 3Cs is changing: We are now geographically diffuse, positioned in different sites of the social factory and on different schedules. This forces us to rethink the locally-situated nature of our research and insist on devising horizontal methods of collaboration across space, availability and different precarious arrangements. In new situations and challenges, 3Cs continues to explore the political possibilities of and, and, and...

## Endnotes

1. An earlier version of this text appeared as Dalton, Craig and Liz Mason-Deese. 2012. Counter (Mapping) Actions: Mapping as Militant Research. *ACME: An International E-Journal for Critical Geographies* 11(3): 439-66.
2. "Precarious literally means unsure, uncertain, difficult, delicate. As a political term it refers to living and working conditions without any guarantees. Precarious work refers to all possible forms of non-guaranteed labor arrangements and flexible exploitation: from illegalised, seasonal and temporary employment to homework, flex- and temp-work, to subcontractors, freelancers or so called self-employed persons" (Frasanito Network 2005).
3. Current militant research practices can be traced back to the Italian practice of *conricerca* (co-research), in which academics and activists collaborated with workers to research the material and subjective conditions of new forms of labor (Negri, 2003). *Conricerca* "developed as communication and cooperation, as a process of resubjectification and counterformation, and as a forum for the autonomous political representation of the 'organized spontaneity' of the workers" (Borio et al., 2007: 168). These practices challenged the division between academic research and political action in the hopes of cooperatively producing new knowledges.
4. The comic book and zine, as well as other 3Cs' documents are freely available at: [countercartographies.org/downloads](http://countercartographies.org/downloads)
5. For more on the project, see: [countermappingmary.blogspot.com/](http://countermappingmary.blogspot.com/) and [lateral.culturalstudiesassociation.org/issue1/content/countermapping.html](http://lateral.culturalstudiesassociation.org/issue1/content/countermapping.html)

## Further Reading

- Casas-Cortés, M. & Cobarrubias, S. 2007. Drifting Through the Knowledge Machine. Shukaitis, S. & Graeber, D., eds. *Constituent Imagination: Militant Investigations // Collective Theorization*. Oakland: AK Press: 112-126. [countercartographies.org/download/drifted\\_through\\_the\\_knowledge\\_machine.pdf](http://countercartographies.org/download/drifted_through_the_knowledge_machine.pdf), 14 January 2018.
- Counter-Cartographies Collective 2009. Practices of Radical Cartography. In The Edu-factory Collective, ed. *Toward a Global Autonomous University*. New York: Autonomedia: 110-113.
- Counter Cartographies Collective, Dalton, C. & Mason-Deese, L. 2012. Counter (Mapping) Actions: Mapping as Militant Research. *ACME: An International Journal for Critical Geographies*, 11(3): 439-466.
- Stallmann, T. 2012. *Alternative Cartographies Building Collective Power*. PhD Thesis. The University of North Carolina at Chapel Hill. [countercartographies.org/download/stallmann-ma\\_thesis.pdf](http://countercartographies.org/download/stallmann-ma_thesis.pdf), 14 January 2018.

## References

- Borio, G., Pozzi, F. & Roggero, G. 2007. Conricerca as Political Action. In Coté, M., Day, R. & Peuter, G., eds. *Utopian Pedagogy: Radical Experiments Against Neoliberal Globalization*. Toronto: University of Toronto Press: 163-185.
- Bousquet, M. 2008. *How the University Works: Higher Education and the Low-Wage Nation*. New York: New York University Press.
- Bunge, W. 1971. *Fitzgerald: Geography of a Revolution*. Morristown, NJ: General Learning Press.  
[jstor.org/stable/j.ctt46nbwg](http://www.jstor.org/stable/j.ctt46nbwg), 14 January 2018.
- Cobarrubias, S. 2009. *Mapping Machines: Activist Cartographies of the Border and Labor Lands of Europe*. The University of North Carolina at Chapel Hill. [countercartographies.org/download/cobarrubiasdiss.pdf](http://countercartographies.org/download/cobarrubiasdiss.pdf), 14 January 2018.
- Cobarrubias, S. & Pickles, J. 2008. Spacing Movements: The Turn to Cartographies and Mapping Practices in Contemporary Social Movements. *The Spatial Turn. Interdisciplinary Perspectives*. New York: Routledge: 36-58.
- Colectivo Situaciones 2007. Something More on Research Militancy: Footnotes on Procedures and (in) Decisions. In Shukaitis, S. & Graeber, D., eds. *Constituent Imagination: Militant Investigations // Collective Theorization*. Oakland: AK Press: 73-93.
- Colectivo Situaciones & de Solano, M.T.D. 2002. *La Hipótesis 891. Más Allá de los Piquetes*. First edition. Buenos Aires: Ediciones de Mano en Mano.
- Crampton, J.W. 2010. *Mapping: A Critical Introduction to Cartography and GIS*. First edition. New York: Wiley-Blackwell.
- Deleuze, G. 1988. *Foucault*. First edition. Minneapolis: University of Minnesota Press.
- Deleuze, G. & Guattari, F. 1987. *A Thousand Plateaus: Capitalism and Schizophrenia*. Minneapolis, MN: The University of Minnesota Press.
- Edu Factory Collective 2008. *Universita Globale: il Nuovo Mercato del Sapere*. Rome: Manifestolibri.
- Foucault, M. 1995. *Discipline and Punish: The Birth of the Prison*. Second Vintage Books edition. New York, NY: Vintage Books.
- Frassanito Network 2005. Precarious, Precarisation, Precariat? *Mute*, 2(0): 60-62.
- Gibson-Graham, J.K. 2006. *A Postcapitalist Politics*. Minneapolis, MN: University of Minnesota Press.
- Gibson-Graham, J.K. 1996. *The End of Capitalism (as We Knew It): A Feminist Critique of Political Economy*. Oxford: Blackwell Publishers.
- Hardt, M. & Negri, A. 2000. *Empire*. Cambridge, Mass.: Harvard University Press.
- Harris, L.M. & Hazen, H.D. 2005. Power of Maps: (Counter) Mapping for Conservation. *ACME: An International Journal for Critical Geographies*, 4(1): 99-130.
- Holmes, B. 2003. Imaginary Maps, Global Solidarities. Piet Zwart Institute. [automatist.org/photo/Pictures/pzi%202002-2006/2003-04-brian\\_holmes/Piet%20Zwart%20Institute%20-%20Imaginary%20Maps,%20Global%20Solidarities.html](http://automatist.org/photo/Pictures/pzi%202002-2006/2003-04-brian_holmes/Piet%20Zwart%20Institute%20-%20Imaginary%20Maps,%20Global%20Solidarities.html), 1 July 2018.
- Holmes, B. 2007. Disconnecting the Dots of the Research Triangle: Corporatisation, Flexibilisation and Militarisation in the Creative Industries. [brianholmes.wordpress.com/2007/02/26/disconnecting-the-dots-of-the-research-triangle/](http://brianholmes.wordpress.com/2007/02/26/disconnecting-the-dots-of-the-research-triangle/), 14 January 2018.
- Lazzarato, M. 1996. Immaterial Labor. In Virno, P. & Hardt, M., eds. *Radical Thought in Italy: A Potential Politics*: 133-47.
- Malo, M. 2007. *Nociones Comunes. Experiencias y Ensayos entre Investigación y Militancia*. Madrid: Traficantes de Sueños.
- Moten, F. & Harney, S. 2004. The University and the Undercommons: Seven Theses. *Social Text*, 22(2): 101-115.
- Peluso, N.L. 1995. Whose Woods Are These? Counter-Mapping Forest Territories in Kalimantan, Indonesia. *Antipode*, 27(4): 383-406.
- Pickles, J. 2003. *A History of Spaces: Cartographic Reason, Mapping, and the Geo-Coded World*. London ; New York: Routledge.
- Precarias a la Derive 2006. A Very Careful Strike: Four Hypotheses. *The Commoner*, 11: 33-45.

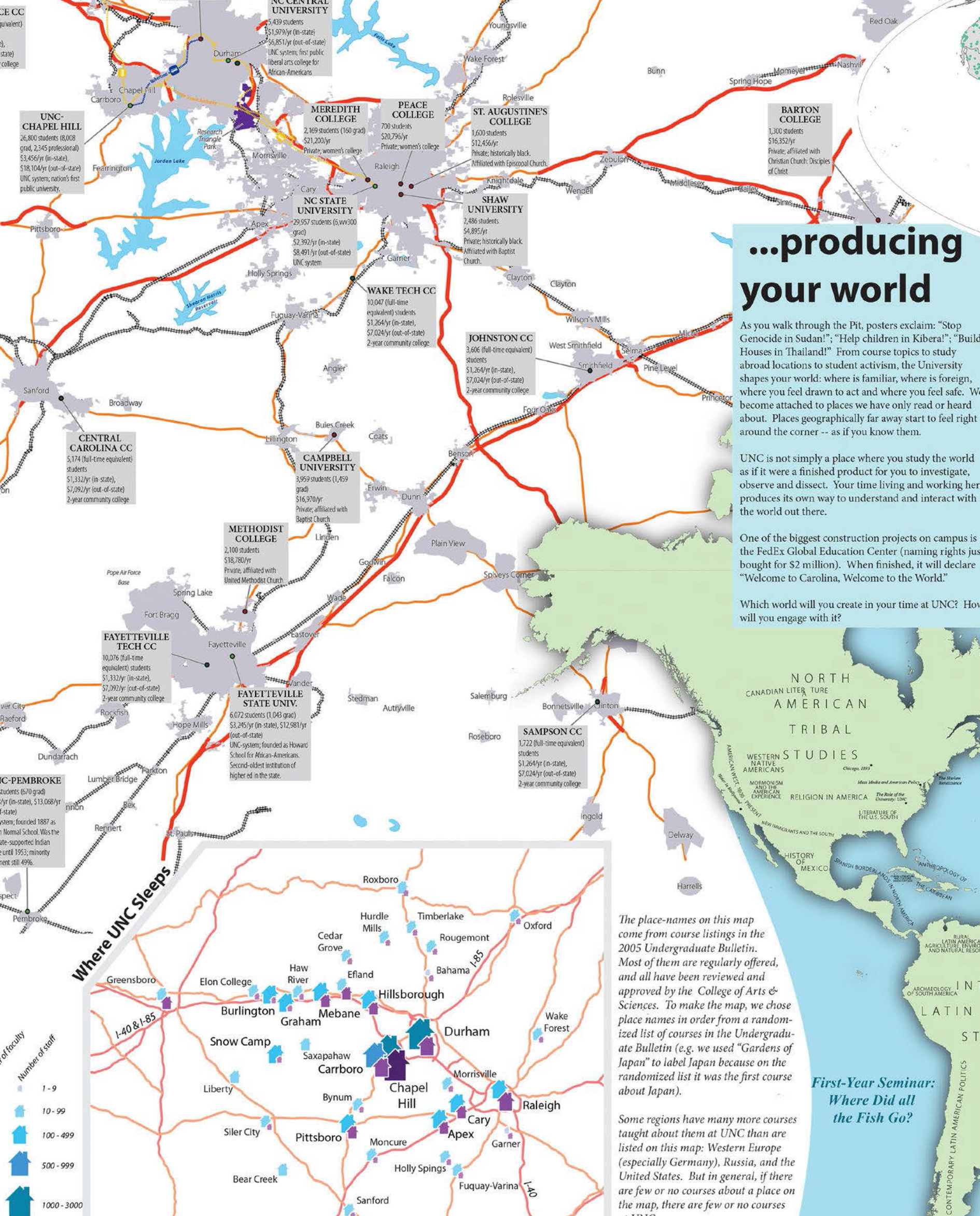

**UNC-CHAPEL HILL**  
26,800 students (8,008 grad, 2,345 professional)  
\$3,456/yr (in-state), \$18,104/yr (out-of-state)  
UNC system; nation's first public university.

**NC CENTRAL UNIVERSITY**  
5,439 students  
\$1,979/yr (in-state), \$6,851/yr (out-of-state)  
UNC system; first public liberal arts college for African-Americans.

**MEREDITH COLLEGE**  
2,169 students (160 grad)  
\$21,200/yr  
Private; women's college

**PEACE COLLEGE**  
700 students  
\$20,796/yr  
Private; women's college

**ST. AUGUSTINE'S COLLEGE**  
1,600 students  
\$12,456/yr  
Private; historically black. Affiliated with Episcopal Church.

**BARTON COLLEGE**  
1,300 students  
\$16,352/yr  
Private; affiliated with Christian Church: Disciples of Christ

**NC STATE UNIVERSITY**  
29,957 students (6,190 grad)  
\$2,392/yr (in-state), \$8,491/yr (out-of-state)  
UNC system

**SHAW UNIVERSITY**  
2,486 students  
\$4,895/yr  
Private; historically black. Affiliated with Baptist Church.

**WAKE TECH CC**  
10,047 (full-time equivalent) students  
\$1,264/yr (in-state), \$7,024/yr (out-of-state)  
2-year community college

**JOHNSTON CC**  
3,606 (full-time equivalent) students  
\$1,264/yr (in-state), \$7,024/yr (out-of-state)  
2-year community college

**CENTRAL CAROLINA CC**  
5,174 (full-time equivalent) students  
\$1,332/yr (in-state), \$7,092/yr (out-of-state)  
2-year community college

**CAMPBELL UNIVERSITY**  
3,959 students (1,459 grad)  
\$16,970/yr  
Private; affiliated with Baptist Church

**METHODIST COLLEGE**  
2,100 students  
\$18,780/yr  
Private; affiliated with United Methodist Church

**FAYETTEVILLE TECH CC**  
10,076 (full-time equivalent) students  
\$1,332/yr (in-state), \$7,092/yr (out-of-state)  
2-year community college

**FAYETTEVILLE STATE UNIV.**  
6,072 students (1,043 grad)  
\$3,245/yr (in-state), \$12,981/yr (out-of-state)  
UNC system; founded as Howard School for African-Americans. Second-oldest institution of higher ed in the state.

**SAMPSON CC**  
1,722 (full-time equivalent) students  
\$1,264/yr (in-state), \$7,024/yr (out-of-state)  
2-year community college

**UNC-PEMBROKE**  
5,439 students (670 grad)  
\$1,979/yr (in-state), \$13,068/yr (out-of-state)  
UNC system; founded 1887 as Normal School. West state-supported Indian school until 1953; minority enrollment still 49%.

# ...producing your world

As you walk through the Pit, posters proclaim: "Stop Genocide in Sudan!"; "Help children in Kibera!"; "Build Houses in Thailand!" From course topics to study abroad locations to student activism, the University shapes your world: where is familiar, where is foreign, where you feel drawn to act and where you feel safe. We become attached to places we have only read or heard about. Places geographically far away start to feel right around the corner -- as if you know them.

UNC is not simply a place where you study the world as if it were a finished product for you to investigate, observe and dissect. Your time living and working here produces its own way to understand and interact with the world out there.

One of the biggest construction projects on campus is the FedEx Global Education Center (naming rights just bought for \$2 million). When finished, it will declare "Welcome to Carolina, Welcome to the World."

Which world will you create in your time at UNC? How will you engage with it?

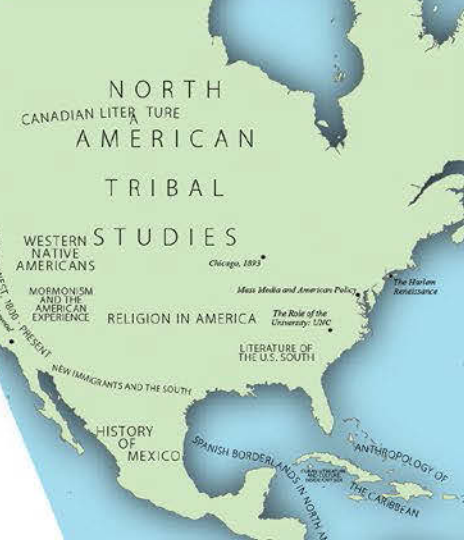

## Where UNC Sleeps



The place-names on this map come from course listings in the 2005 Undergraduate Bulletin. Most of them are regularly offered, and all have been reviewed and approved by the College of Arts & Sciences. To make the map, we chose place names in order from a randomized list of courses in the Undergraduate Bulletin (e.g. we used "Gardens of Japan" to label Japan because on the randomized list it was the first course about Japan).

Some regions have many more courses taught about them at UNC than are listed on this map: Western Europe (especially Germany), Russia, and the United States. But in general, if there are few or no courses about a place, there are few or no courses

## First-Year Seminar: Where Did all the Fish Go?



**Graduate Research at UNC-CH, 1996-2005**  
 Each dot represents a specific place mentioned in the title of a dissertation written by a UNC graduate student.  
 Source: ProQuest CurrentResearch@UNC database, and Metacarta Labs

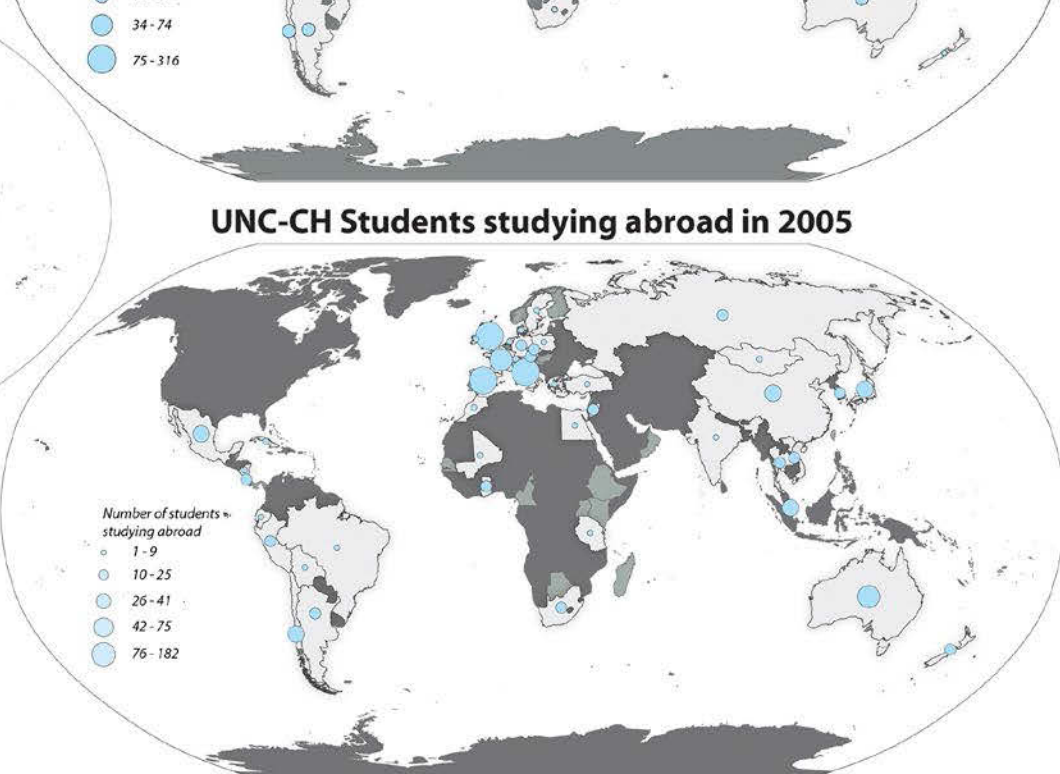

**UNC-CH Students studying abroad in 2005**

Number of students studying abroad

- 1 - 9
- 10 - 25
- 26 - 41
- 42 - 75
- 76 - 182

Country where UNC students studied abroad in 2005-2006    Country where no study abroad programs are endorsed by UNC    Country where UNC-endorsed programs are offered, but no students studied in 2005-2006

Source: Fall 2005 Passport and Study Abroad Office

**A note on projections...**

We used a Mercator projection for *The World Through Course Titles* (below) because it has historically been used for navigational maps, which we wanted to evoke. As a rectangular, navigational map, it grossly distorts the size of landmasses (despite its appearance below, Greenland is, in fact, only about the size of Mexico). We used a round Mollweide projection for the graduate research map (above) because it preserves areas, making the relative areas of each country equal to all others and thereby allowing direct comparisons of dot density. The study abroad and international enrollment maps to the right both use the Robinson projection. It spreads the globe in a way that makes individual countries and symbols easier to distinguish, but distorts areas near the poles. The map on the front cover uses our own antipodal projection, where the center of the map is the point opposite Chapel Hill on the globe, and the outer edge of the map is North Carolina (and Chapel Hill).



**THE WORLD THROUGH COURSE TITLES**

# Mapping the Squatting Movement

Pappsatt-Kollektiv – Tobias Morawski

[berlin-besetzt.de](http://berlin-besetzt.de)





In the beginning of the 1980s the squatting movement was an important topic within the local politics of Berlin. This movement was triggered by increased housing shortage while entire streets of apartments were being evicted, ultimately leading to their decay. The fall of the Berlin Wall in the beginning of the 1990s was followed by a second squatting wave which led to the formation of many self-governed cultural spaces in Berlin. Even today there are hundreds of residential and cultural spaces in the city which emanated from former squats.

While different urban protest movements were regaining strength, 2012 marked the increase of many house and place squattings. For example, in June of 2012 retirees squatted their meeting point in the district of Wedding in order to ensure that it would survive. Residents from around the subway station Kottbusser Tor built a "Gecekondu", a hut as a location to meet and protest against rising rents and displacement. The hut is still there and in use today. At the end of 2012 refugees organized a protest camp at Oranienplatz to fight against their bad living conditions. They also squatted a former school building in Kreuzberg during the so-called "Refugee Strike" in December of 2012. These current examples show that squattings have had and continue to have a significant meaning for social battles in Berlin. The project Berlin besetzt (English: Berlin squatted) wanted to depict the Berlin squatting history in form of an interactive city map. Since the central topic of the house squatting movement is the appropriation of urban space, its history must be presented spatially.

Berlin Besetzt is an interactive online street map combined with a digital archive about the history of house and place squatting in Berlin. The project tells the story of house squattings in Berlin as an example of the self-empowered interventions of protest movements in urban space and urban life. The map explains the motivations for squatting, revealing some of them and also showing what has become of the created places today. The map wants to visualize collective and self-governed spaces, meaning the representation of resisting actors and spaces within the struggle for the right to the city in order to show that political fights/ movements can be successful. The map is intended to be a contribution to the political debate and to show the urban space of Berlin as a result of fights for appropriation of space. The starting point for this description is today's Berlin – the visible result of the movement.

## The Formation Process Visualizing the Movements Archive

Since the topic "house squattings in Berlin" has so far been covered only by few scientific publications in its entirety, the used data are based primarily on in-scene publications, newspaper articles and our own research. Some documents are fragmentary and contradictory at times. In many cases "scientific" verification is hardly possible. Several years of research were initiated to close the knowledge gaps in urban and movement history.

The Papiertiger archive and the Kollektivbibliothek Bethanien, both archives of social movements in Berlin, provided us with ample original documents on house squatting in Berlin. We collected data on locations and times of the squattings, the history of the

single houses and the events of the history of the movement from sources such as flyers, journals and journal articles (of which we were able to digitalize a large amount). We were also able to convince Umbruch Bildarchiv to contribute their comprehensive photo collection to the project. A timeline of events was taken from the book *Autonome in Bewegung* (Grauwacke, 2008) and edited. In addition, we interviewed activists, some of whom were from different eras and some of whom had participated in the squatting, during which we had painstakingly created growing Excel tables.

The collected data were entered into a database which was then connected to an Open-Street-Map. This map is visually accessible online at berlin-besetzt.de. The Excel tables containing the raw data are also updated regularly and can be downloaded from the website (see section "About" for a link). The map's display method enables a fast overview of hundreds of project spaces as well as an intuitive navigation through a comprehensive archive of thousands of datasets and documents on squatting actions. The project is supposed to be self-explanatory, thus being accessible for people without prior knowledge. At the same time it should supply detailed knowledge for experts and scientists. We decided to use a factual and universally accepted picture language that addresses not only subcultural scenes. The online map is primarily intended for the use with the computer at home. Nevertheless, it can also be used for exhibitions and individual city explorations with the use of the smartphone.

## Reactions to the Publication

The website's publication created an enormous echo. The press and the social networks circulated the news of the publication like a political sensation. We received a lot of e-mails in which (former) activists and members of initiatives and housing projects expressed their gratitude, congratulated us or sent us corrections. By now the project has repeatedly been cited as a source on different occasions focusing on the topic of squatting. Even the German Historical Museum has exhibited the website temporarily as a computer terminal. On the one hand, this shows the importance of conducting your own historical work, instead of leaving it to mainstream media and science institutions. On the other hand, it shows the power of easily understandable visualizations.

Interesting is that we often received feedback from mostly older activists, telling us that the re-writing of the squatting history was unnecessary and useless since the movement already failed and is over. However, the reactions to the publication showed the opposite to be the case. The boulevard newspaper *Berliner Kurier*, for example, contributed a whole double page spread to the coverage under the headline "The squatters' second summer – They are still there even though the spook should be over by now" (Fleischmann, 2014). The part that focuses on "the squatters' second summer" cannot mean the revival of house squattings: Prior to the publication of the map, there were hardly any successful squattings in the past 20 years. Moreover, it must be the publication of the map that was perceived as an uprising of the movement since it again visualized the struggles for a right to the city.

## The Lessons of International Dissemination

In collaboration with the SqEK (Squatting in Europe Collectives), a network made up of activists and researchers on the topic of



house squattings, there was the opportunity to publish an international version of the map. The data for this map had been collected by SqEK members within the context of the MOVOKEUR project. The latter was a collective research project on house squattings in Europe. However, the realization of this project confronted us with some problems we have outlined as follows:

- The work in a large group structure meant enormous additional effort. For example, the collective communication via e-mail is a tough process if it covers many countries with different languages.
- If and how the maps will be further updated depends on the individuals' willingness to engage in hard voluntary work or to find alternative possibilities of financing. The running costs for things like web servers and programming can also be an obstacle.
- A common website/map seems to provide an objective comparability of the displayed information. Yet in reality only a few cities were incorporated into the work. The research for every city was conducted by different groups or single individuals. Depending on the availability of information sources, prior knowledge or individual work speed, some data sets are mostly complete while others are far from being complete.
- There are also differences in the evaluation of what is important for the history of certain movements. The Barcelona map, for example, only shows social centers since residential squattings occur too often to depict all of them. Similar to Madrid, they mostly exist informally in order to avoid discovery and subsequent eviction. In Italy people even protested against the publication of the map, since the available information could lead to attacks by Neo-Nazis and the police.

This leads to the final question if it wouldn't be more sensible to always produce independent maps, that live up to the standards of

differences between movement history, the data research as well as the intention of producing the map in the first place. It would be nice to find a creative solution in order to show similarities and relations of the movements to each other. We all can definitely learn a lot from their histories.

#### References

- Fleischmann, M. 2014. Die Szene Lebt: Der Zweite Sommer der Hausbesetzer. *Berliner Kurier*. [berliner-kurier.de/berlin/kiez---stadt/die-szene-lebt-der-zweite-sommer-der-hausbesetzer-1030090](http://berliner-kurier.de/berlin/kiez---stadt/die-szene-lebt-der-zweite-sommer-der-hausbesetzer-1030090), 13 June 2017.
- Grauwacke, A.G. 2008. *Autonome in Bewegung: aus den Ersten 23 Jahren*. Berlin: Assoziation A.

#### Links

- [maps.squat.net](http://maps.squat.net)  
[sqek.squat.net](http://sqek.squat.net)  
[movokeur.wordpress.com](http://movokeur.wordpress.com)

#### Illustrations

Map by Pappsatt Collective / [reclaimyourcity.net](http://reclaimyourcity.net) in collaboration with Papiertiger archive, Umbruch image archive, Kollektivbibliothek Bethanien, Eike Send etc. Photograph previous page left by Michael Kipp / Umbruch Bildarchiv: Eviction at Fränkelufer in Kreuzberg on 24 March 1981.

Photograph this page by Manfred Kraft / Umbruch Bildarchiv: Skaltzer Straße in Kreuzberg between Kottbusser Tor and Görlitzer Bahnhof, beginning of the 1980s.

Photograph opposite page top by Oliver Feldhaus / Umbruch Bildarchiv: In September 2014, refugees occupied a roof top on Guertelstraße in order to protest against inhumane and illegal asylum politics by the Berlin Senate, and to demand basic services.

Photograph opposite page bottom by Nico Baumgarten: The empty lot on Curry Straße was home to a diverse group of people until their eviction in 2014.

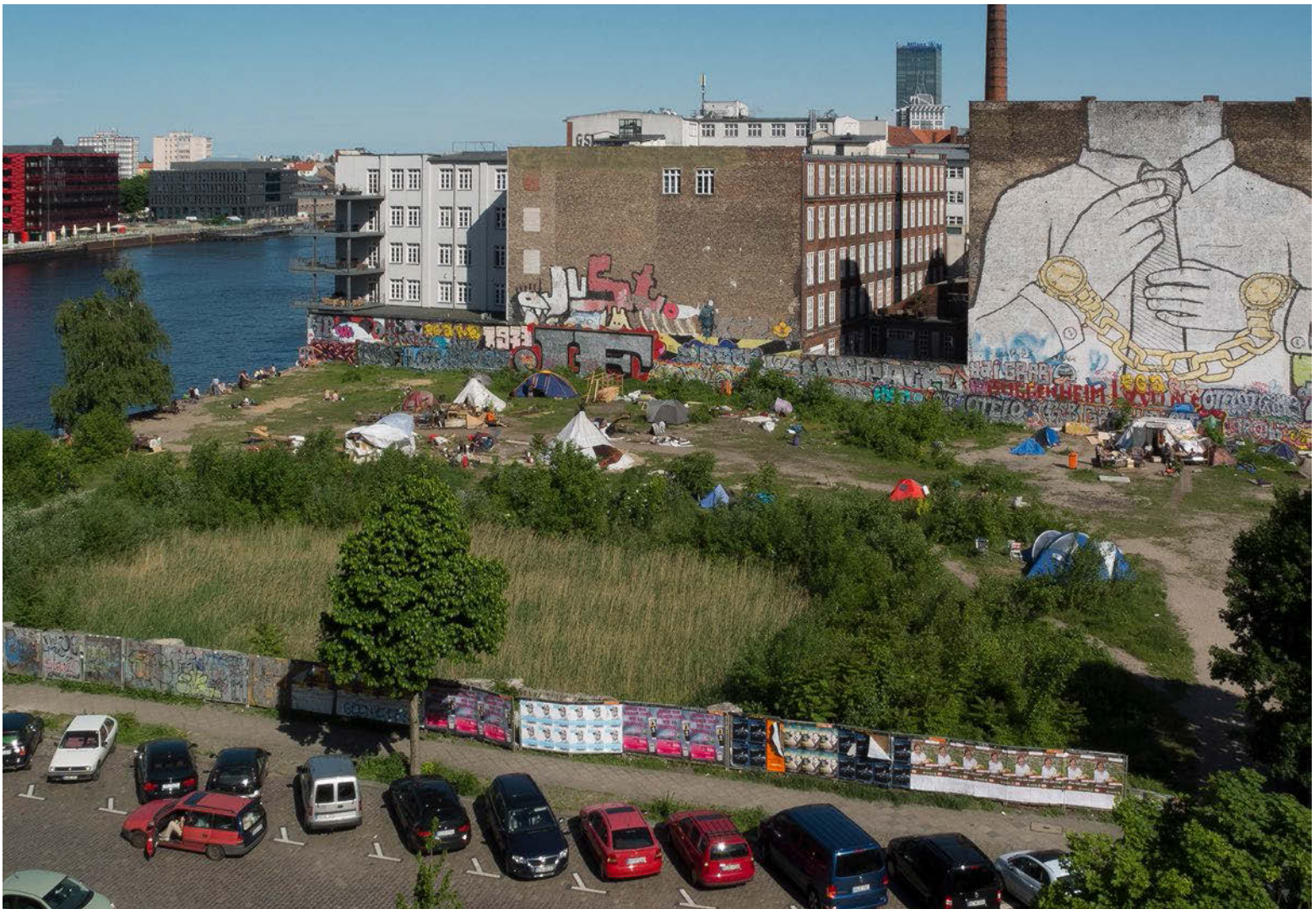

# BERLIN BESETZT

## Squatting Movements in Berlin

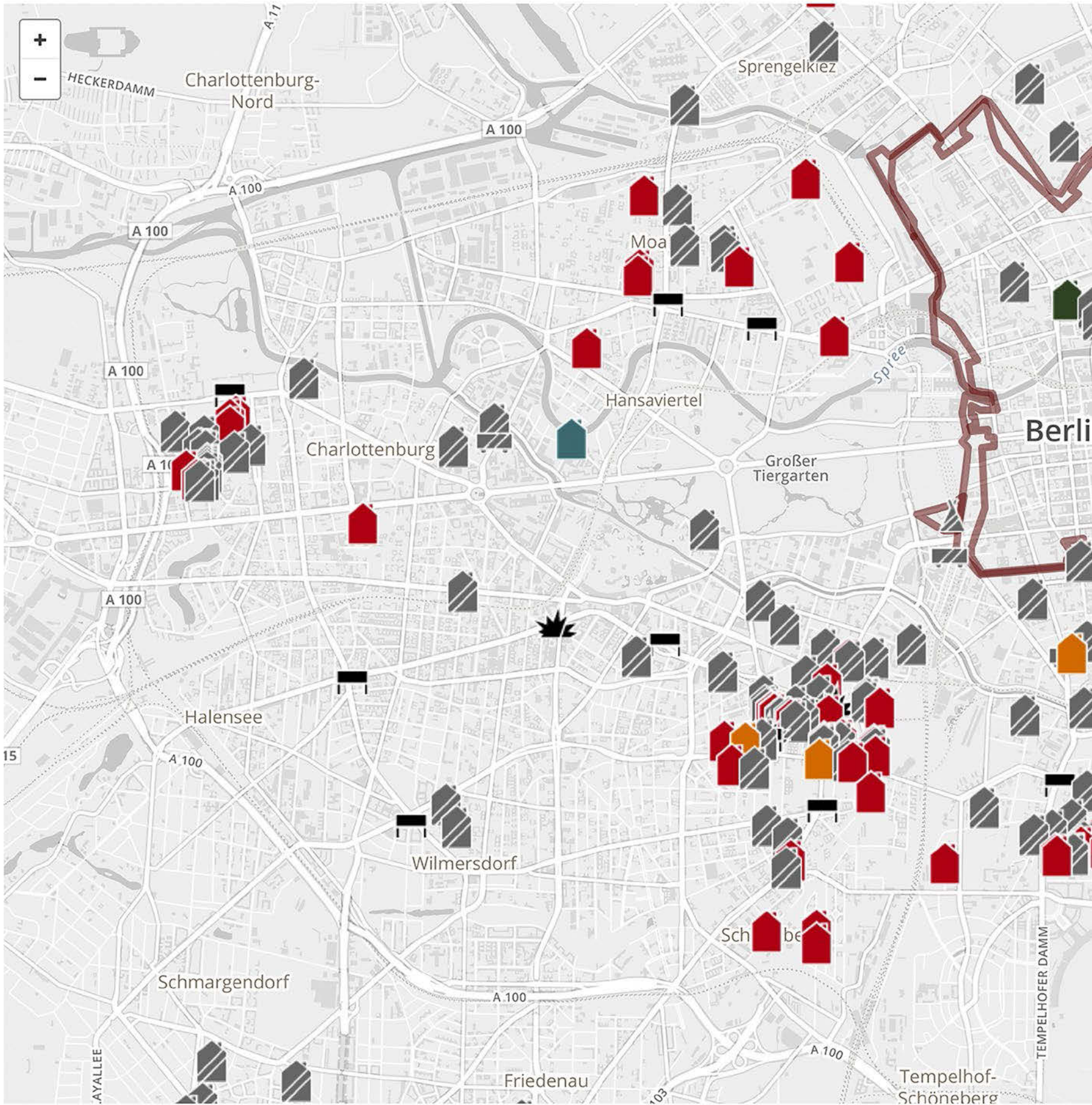

This screenshot of the homepage has been translated for its publication here.

[View All](#)

All  1970

**Legend**

<b>SQUATS</b>	House	Caravan site	Occupied public space	<b>EVENT</b>	Demonstration	Riot
Moment of Squatting since 1970 1980 1990 2000 2010 ...		evicted		<b>OTHER</b>	Berlin Wall	

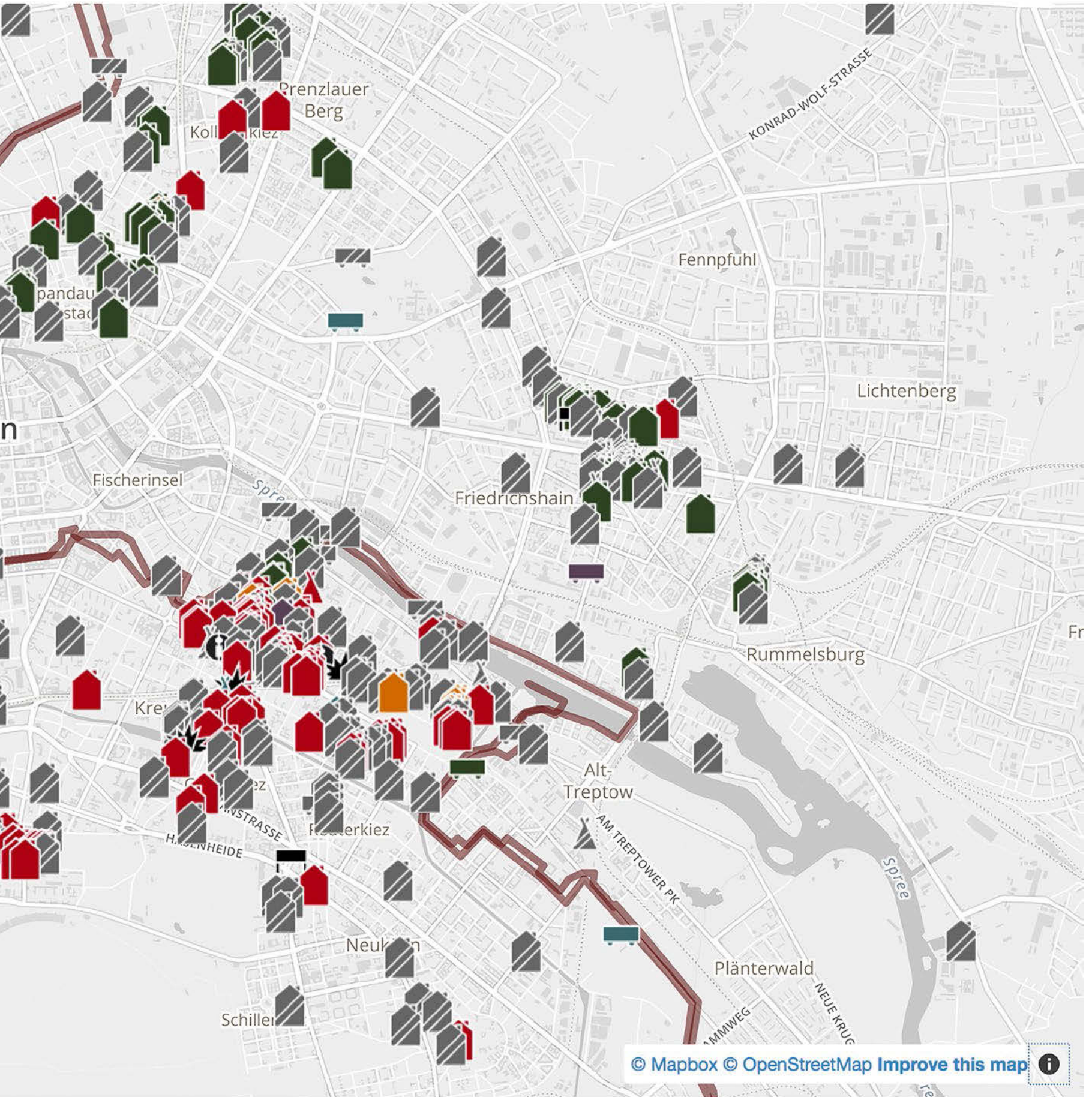

today

[About](#) [Imprint](#)

**Content of the map**

With the help of a time axis, the developments and spatial dispersion of house squattings become interactively comprehensible.

Annual overviews, a chronic, texts on the history and the imagination of different squatting maps (house squattings, corrals, place squattings) explain the context of the history of the places the movement created and the Ber-

lin city politics. Also they shed light on the reasons of conflict as well as the impact on the social and cultural life in the city and the different districts.

Detailed information on the individual places and connected archival material, such as self-descriptions and publications (posters, flyers, journals, brochures) explain the intention of the squatting and the use of the opened spaces.

# Emancipatory Mapmaking: Lessons from Kibera

Erica Hagen, Julian Stenmanns, Till Straube  
mapkibera.org



Modern mapmaking in the global South has been deeply entwined with the colonial endeavor of producing legible spaces. Critical Geography has emphasized the role of maps in governing populations and their politics of in/visibility, especially concerning marginalized communities. What else can maps do? How can communities and activists deploy mapping technologies as tools that support marginalized communities by promoting recognition, political participation and access to basic services?

Julian Stenmanns (JS) and Till Straube (TS) spoke with Erica Hagen (EH), co-founder of Map Kibera, a community-based open source mapping project in the neighborhood of Kibera in Nairobi, Kenya, about her experiences with participatory mapping and the politics of in/visibility.

*JS: What were some of the motivations behind Map Kibera?*

EH: Map Kibera started in 2009. The concept came up at a mapping conference in Nairobi. A group of geographers and others were traveling to Nairobi to talk about mapping, and being in Nairobi, you can't help but notice that Kibera is a really prominent and visible place. It is central to the city and a very large slum area. However, the participants of the conference, who were also interested in open source geography, noticed that Kibera wasn't mapped at all. Moreover, as we looked for the official registers, we discovered that authorities labeled and designated the area as a forest. Therefore, we wanted to change this, not from the viewpoint of an international NGO, but rather mapping it from the perspective of the residents.

*TS: How did you go about starting the project?*

EH: We began by teaming up with a local community service organization that was willing to host us and introduce us to the community. That was key because we couldn't just walk around by ourselves. Simply showing up would be very hard. You would get lost within five minutes if you aren't from the area. In addition, you could end up in a precarious situation, not necessarily dangerous, but there is bit of resistance to outsiders just wandering around. Furthermore, mapping from the outside was no option for us. Besides, when you look at satellite imagery of the area, there is not much that you can see in terms of details of the features, which is also due to the density.

*JS: Can you tell us about the work processes that went into making the actual map? What would your typical day look like?*

EH: First we recruited some young adults between 18 and 25 years old who lived in the area. They were familiar with the neighborhood and involved in the community. Seven years ago, smart phones and computers were not widely distributed in Kibera. Therefore, they first had to familiarize themselves with the GPS devices. We had at least one person from each of Kibera's thirteen villages, and we told them to map what they felt was important to be visible in their village. This was the beginning of a waypoint collection, just by pushing the button of the GPS device and writing down whatever the place was. We didn't really give them any more instructions. So

it was up to them what they were going to mark. That way we made sure to keep the map as locally informed as possible.

*TS: In retrospect, are there some things that would have been useful to know when starting out? What were the steep parts of the learning curve?*

EH: The challenges that we hadn't expected were more of a social than of a technological nature. We weren't really able to pay people. However, we realized that they spent all day with pretty tiring work and they were expecting to have at least some kind of compensation. So we arranged for a little stipend. Moreover, later on it became more of a challenge of how to make it all part of the big picture: How do we make this information as relevant as possible for the community?

*JS: Speaking of the community, what kind of maps – mental or otherwise – existed prior to Map Kibera?*

EH: Yes, there were a couple of different ones. The spatial comprehension in the communities was pretty interesting. The main navigation method is based on landmarks. Therefore, we wanted to make sure that we got the major landmarks on the map. We didn't expect people to use the map to go to the grocery store in the community. Rather, we started with printing out sectoral maps. For example, we put all health-related places together in one map and shared it with the community. This way the bigger picture of health in Kibera became visible and could also be used when facing government officials.

*TS: The technology of cartography comes with some historical baggage. What did it mean for you to engage in mapmaking in a postcolonial context?*

EH: If we dealt with these issues it was on a very local, concrete level. Although many aspects of life in Kibera are actually pretty formalized, it remains an informal settlement without official approval, and inhabitants are very aware of this issue. Government maps designate the site of Kibera as a forest area. In many ways, becoming visible on the map was a matter of pride for the people we worked with.

*JS: What does it mean to put Kibera on the map in a political sense? What are the concrete political achievements and the achievements of putting Kibera on the map?*

EH: Over the past few years, we've been working with local schools. In Kibera, there are around 300 schools, many of them organized by non-state providers. So none of the people who are providers of those schools or who teach there seemed to be represented in this way. The map legitimizes their work. A local government officer of education started copying the maps and distributing them to help show others the education landscape of Kibera. In the individual schools, the maps and all the information they contain become somewhat part of the curriculum. It also became widely known that government schools covered only few of the students, which became a point the Kibera Minister of Parliament used to try to draw more resources.

*TS: Your map grants visibility on a global scale. What are the consequences of putting local knowledge into the public domain?*

EH: Yes, there definitely has been a lot of visibility through the map. Without the map, nobody would have paid much attention to that specific little dot on the map. So how did we deal with this visibility? I guess the main way was to ask ourselves if the mapping process and its product would put people at risk. Because Kibera and other places like it are contested and vulnerable locations, especially given the fact that there is a lot of activity that is not formalized. Most slums get their electricity through informal connections to the grid. But we wanted to emphasize the aspect of protection through visibility. Becoming more visible can also lead to more protection because things that happen can be known – even globally – and that provides people with a sense of security. Whoever tries to do a crack down on informal housing will become very visible. Finally, people in Kibera have a strong sense of community and they will say: This thing we don't want to be known, so we don't want to put it on the map. So that's the guideline we followed. We just followed the people's lead – and they tend to imagine a lot more visibility than what is actually there.

*JS: How did the nature of OpenStreetMap as your main platform inform the goals of the project or its emancipatory potential? Would this have been possible with a paper map?*

EH: Map Kibera as a paper map as in offline only? No, that would definitely not have been possible since we really intended to connect to wider audience. This thing is more than a data tool; it is a communication and broadcasting tool, so by definition this requires the internet and information technology. This way the community can update its map so it is truly an open, participatory map of and by the community. We did, however, distribute printed maps as well, and this has been a key to making sure the information reaches more local people. The schools maps were given to each school on paper. So it is important to consider the best ways to access people as well as allow them to take part in digital open mapping.

*TS: Thank you for the interview.*

EH: Thank you.

## Conclusion

After speaking with Erica Hagen, we revisited the different representations of Kibera on GoogleMaps and OpenStreetMap. When comparing the two maps side by side, the difference is indeed striking: while the visualization on Google's platform in no way suggests a dense and vibrant neighborhood, Map Kibera's data on Open Street Map lends itself to be read as a bottom-up mapping of locations that matter to the community. Since its start in 2009, Map Kibera has thus been facilitating an alternative cartographic articulation of Kibera, available to both its residents and to people remotely accessing online maps of the area.

Finally, while we agree with Erica Hagen's elaborations on the merits of the Map Kibera project and community mapping in general, we also want to draw attention to the ambiguities that inherently accompany undertakings of mapping marginalized communities. Cartography is deeply rooted in a specific way of seeing. Google's Beyond the Map project employs drones and cameras mounted on motor scooters to explore Rio de Janeiro's favelas, an "uncharted and mysterious spot on the map [...]" (Google 2017). Not only is this language revealing when it comes to who sees and who is seen, but Google is actively pushing the frontier of what is visible, accessible and governable into terrains previously indiscernible for capital and the state (Luque-Ayala & Neves Maia 2018). This aspect is certainly reminiscent of the colonial project of rendering populations and spaces legible through cartography. It is therefore a key challenge for community mapping projects to be aware of the complex politics of in/visibility and to discern ways to realize their emancipatory potential within this field of tension.

## References

- Google 2017. Google Presents Beyond the Map. [beyondthemap.withgoogle.com](http://beyondthemap.withgoogle.com), 19 May 2017.
- Luque-Ayala, A. & Neves Maia, F. 2018. Digital territories: Google maps as a political technique in the re-making of urban informality. *Environment and Planning D: Society and Space*, 0: 1–19.

## Illustrations

Map on following spread: Kibera and surrounding areas as they appear on OpenStreetMap. © OpenStreetMap contributors.

Photograph on previous spread by Map Kibera Trust: Lucy Fondo of Map Kibera assists a teacher in Kibera in finding their school on the map.

Photograph on opposite page top by Map Kibera Trust: Douglas Namale maps a school in Kibera for Map Kibera's Open Schools Kenya project.

Photograph on opposite page bottom by Map Kibera Trust: A wall in Kibera is painted with the security map created by Map Kibera.



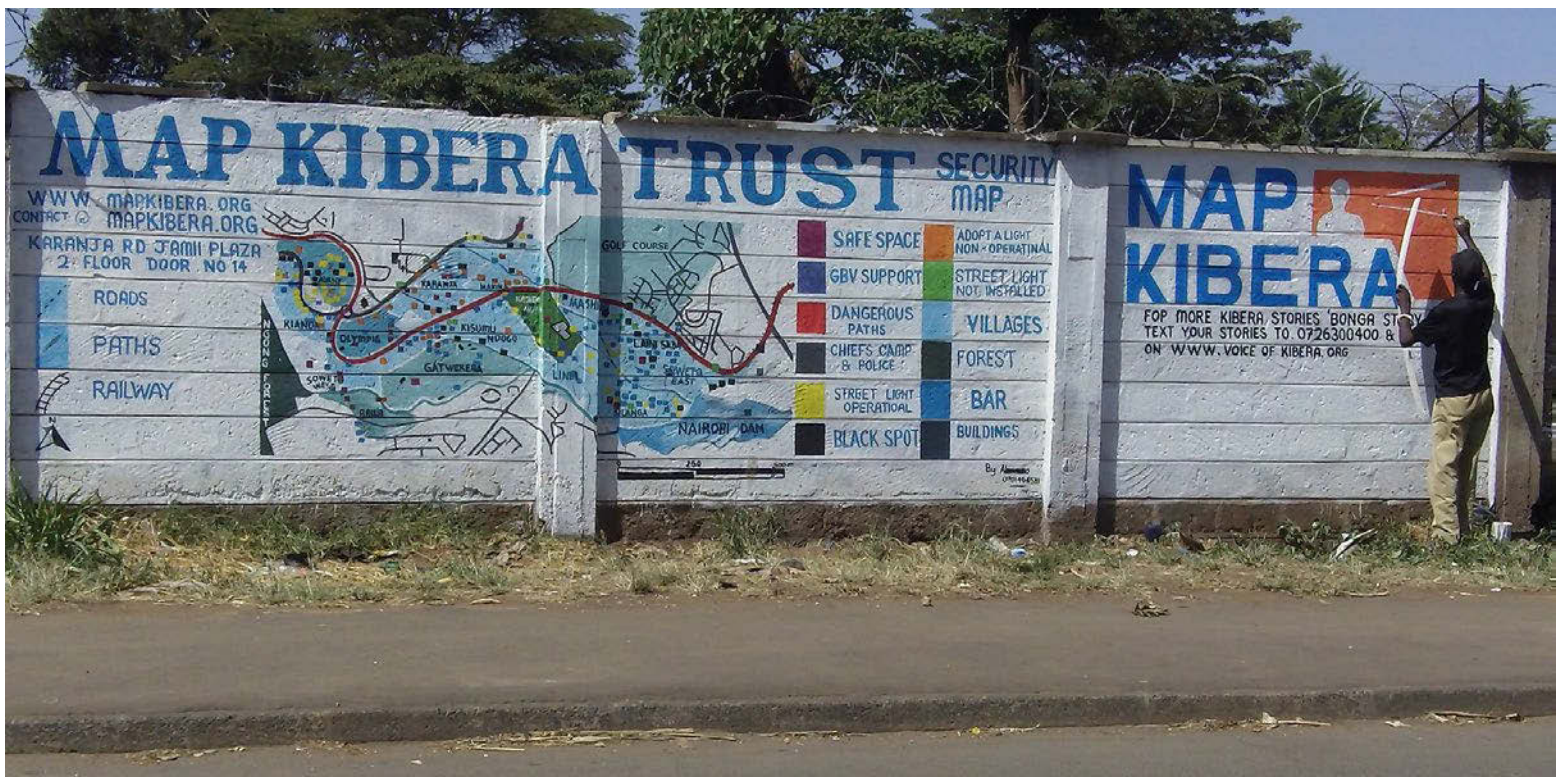

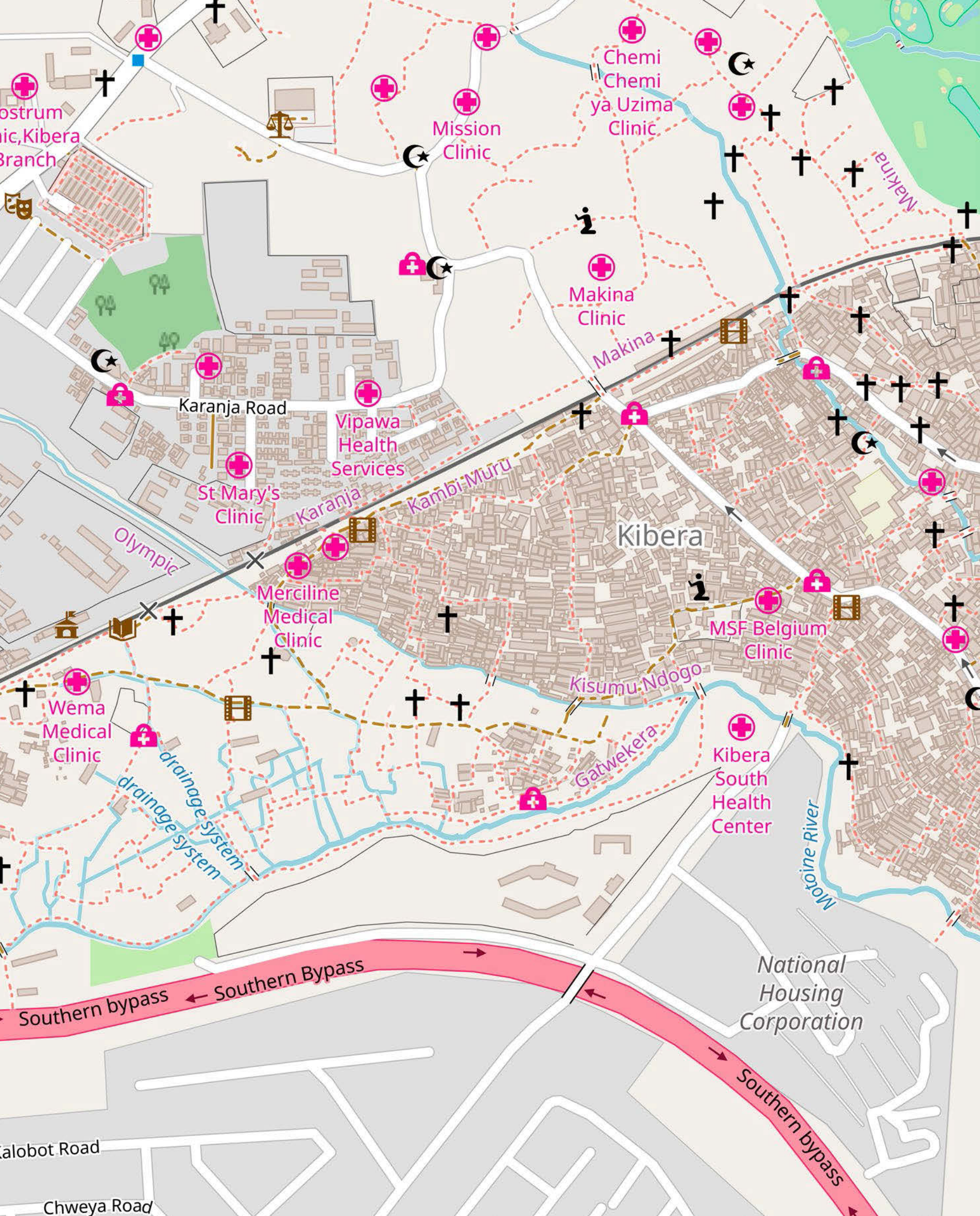

Prostrum  
ic, Kibera  
Branch

Mission  
Clinic

Chemi  
Chemi  
ya Uzima  
Clinic

Makina  
Clinic

Karanja Road

Vipawa  
Health  
Services

St. Mary's  
Clinic

Karanja

Kambi Muru

Kibera

Olympic

Merciline  
Medical  
Clinic

MSF Belgium  
Clinic

Wema  
Medical  
Clinic

Kisumu Ndogo

Gatwekera

Kibera  
South  
Health  
Center

drainage system

Matoini River

Southern bypass

National  
Housing  
Corporation

Southern bypass

alobot Road

Chweya Road

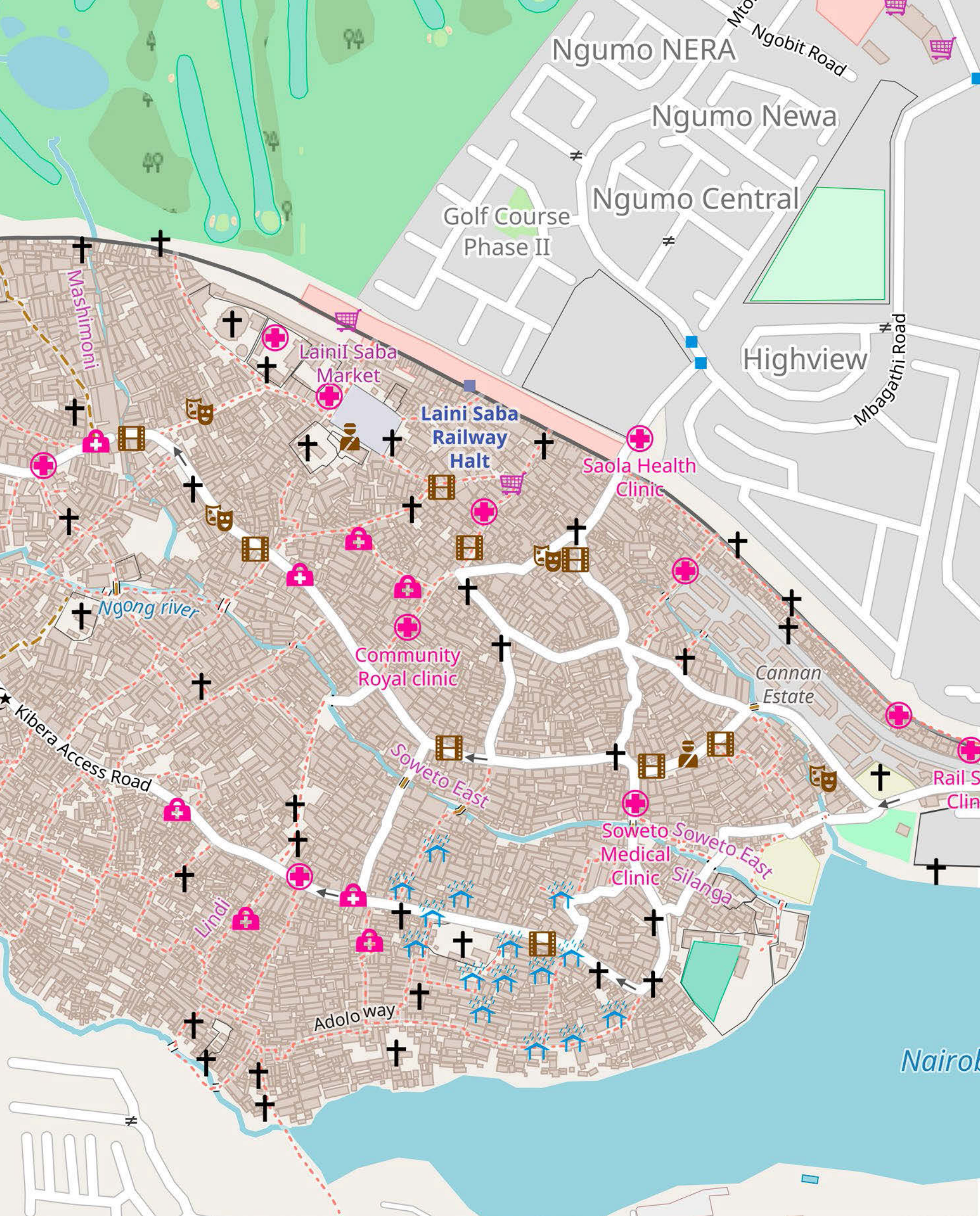

Ngumo NERA

Ngumo Newa

Ngumo Central

Golf Course  
Phase II

Highview

Laini Saba  
Market

Laini Saba  
Railway  
Halt

Saola Health  
Clinic

Community  
Royal clinic

Cannan  
Estate

Kibera Access Road

Soweto East

Soweto Soweto East  
Medical  
Clinic

Lindji

Adolo way

Nairobi

Mto Ngobit Road

Mbagathi Road

Mashimoni

Kibera Access Road

Ngong river

Silanga

# Mapping Postkolonial

## An Archive of Post/Colonial Traces, Layers and Spectres in Munich

Eva Bahl, Simon Goeke, Zara Pfeiffer, Peter Spillmann, Michael Vögeli, Philip Zölls

[mapping.postkolonial.net](http://mapping.postkolonial.net)



## **mapping.postkolonial.net**

The map is a cooperation of [muc] münchen postkolonial, Zurich-based Art Project Labor k3000 and the Munich-based Ecu-  
menical Office for Peace and Justice e.V.. The project was funded by the Foundation Remembrance, Responsibility and Future (Stiftung EVZ).

We are a team of researchers, activists, artists and programmers/software engineers. Our academic backgrounds are somewhere between the arts, sociology, anthropology, political science and history. Some of us have worked on critical mapping before; some of us are part of the group [muc] münchen postkolonial that has done activist research on post/colonial traces in Munich and has been involved in different decolonizing projects and actions since 2006. Many of these experiences and much of this knowledge have found their way into our postcolonial map of Munich.

## **Decolonizing Munich**

Unlike cities such as Hamburg – with its access to the sea – and Berlin – as the capital of imperial Germany – Munich was not a hub of colonial activity. Nevertheless, colonialism is also deeply ingrained in Munich's civic society, having shaped it on a sustained basis through the ages. The numerous remnants and traces of colonialism that can be found to this day inside Munich testify to the history and continuing presence of post/colonial realities. At the same time there are a number of traces and places whose colonial associations are no longer, or only very obliquely, evident today. Despite being unseen and unspoken, these frequently tell us more about our present dealings with the colonial past than the supposedly obvious ones. Tracing their history, inquiring into the historical contexts of their rises and declines, and articulating the frequently unspoken forces they represent will change the way we

see the city. mapping.postkolonial.net presents a snapshot of this investigation, which does not seek to present Munich as having had a special role in colonialism. The aim is rather to expose the seemingly commonplace banalities of colonialist world views and post-colonial conditions for contemplation and debate – in their full diffusion and impact. Exposing and reflecting on these is both a precondition for, and a part of, the process of decolonialization. The project maps post/colonial vestiges in Munich. Some of these are still visible in the city, some require an intent view, many stay invisible: the statue of a colonial sculptor, the fading marks of a colonial memorial plaque on a cemetery wall, a renamed street, a non-existent grave. The obvious and hidden vestiges in the city function as a vision panel to get a closer look and question the present and past of post/colonial relations.

## **How to Use It**

There are three different approaches to use the website mapping.postkolonial.net.

### **Mapping**

The interactive map of Munich shows numerous traces of the city's colonial past. By clicking on some of the crosses, the history of the traces, narratives and theoretical layers are revealed.

### **Trip for Traces**

If you like to do your own research in the city, there are several thematic tours recommended. A version for mobile devices navigates you through the tours. For further information visit the website mapping.postkolonial.net/m.

### **Archive**

All traces, narratives and theoretical layers are listed in the archive. There you will also find additional material, sources and the exact location marked on a city map.

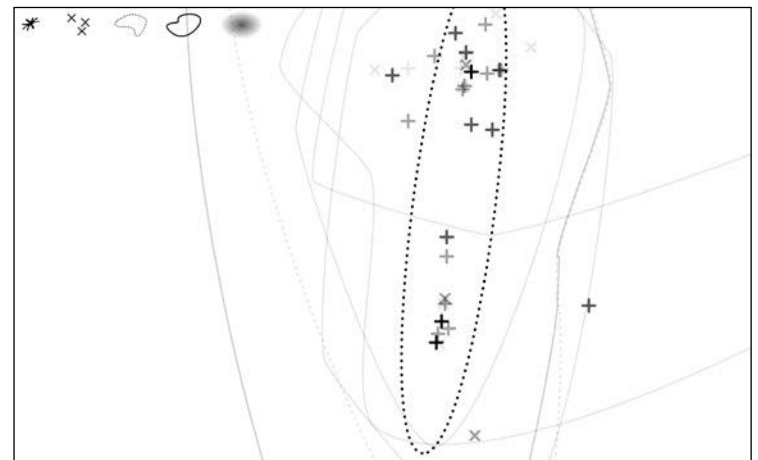

### Search for Traces

Traces of the colonial past can be found all over the city. Traces can for instance be places, sculptures, tombs, commemorative plaques, museum exhibits and street names. They are linked with events, protagonists of the colonial history.

The Von-Trotha Street was renamed as Herero Street in the year 2007. The new street name commemorates the anti-colonial resistance of the Herero people against the authorities in the German colony South-West Africa. The street is also dedicated to the victims of the genocide (1904-1908) that followed the resistance activities. General Lothar von Trotha – the former name patron of the street – had commanded the annihilation campaign of the German "Protection Force". There are still about 30 streets in Munich that are named with a clear positive reference to colonial actors, places and events. The Munich Foreigners' Advisory Council and other groups have repeatedly demanded the renaming of these colonial streets.

### Narratives

The Narratives are telling the common story of different vestiges of Munich's colonial history. Referring to historical events, the narratives relate the impact and agency of the protagonists of colonial history.

A plaque was installed at the New Town Hall in 1913 to commemorate German soldiers who had been killed in the colonies. During renovations in the 1960s the plaque was damaged and taken down. A new commemorative plaque was installed at the Old Southern Cemetery. After having been paint-bombed and sprayed repeatedly, it was first fixed at a higher level and then removed. After another restoration the plaque was re-installed at a more visible and controllable place outside the cemetery (see photographs on previous spread).

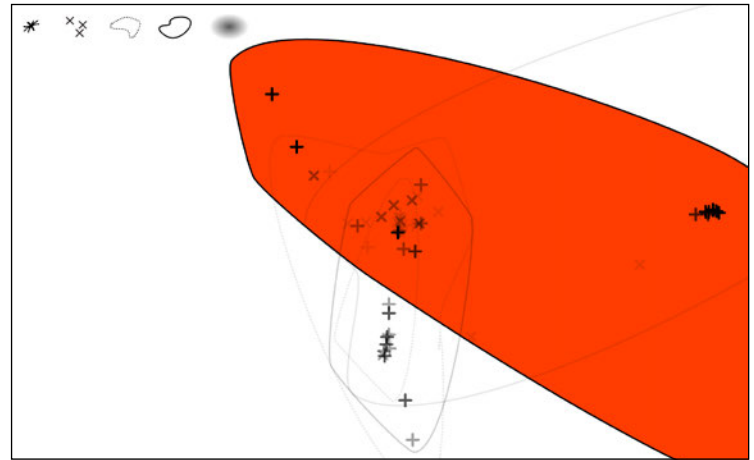
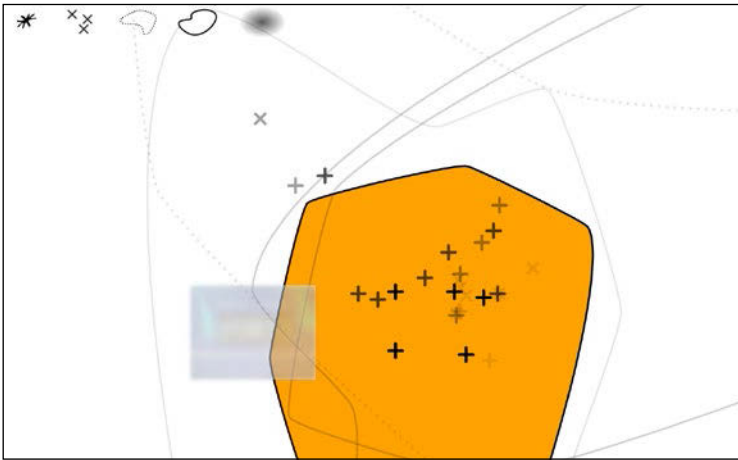
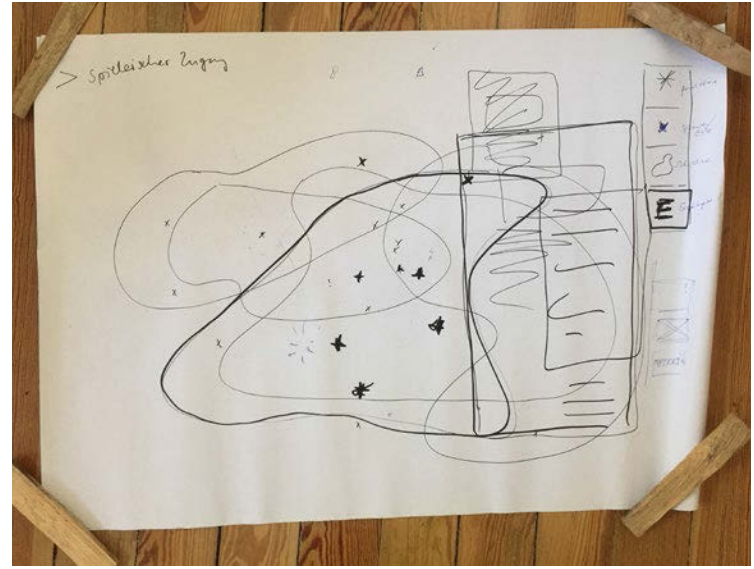
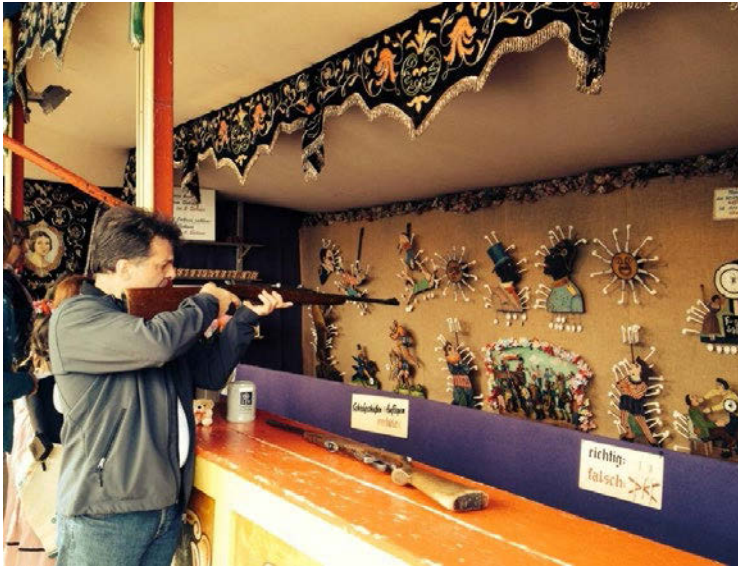

### Spectres of Colonialism

Colonialism is dead yet it still lives on. As a shadow of the colonial past, it continues to haunt people and societies, even though this is barely noticeable at times: in colonial furniture, in the colonial style featured by delicatessens and restaurants, revived in commercials, films and documentaries, and in clinging to colonial monuments, street names and racist appellations and epithets. Time and again attempts to exorcize these specters in disputes about street names or racist terms in children's books demonstrate how flexible, protean and yet persistent they are. Colonialism is dead and yet it still spreads calamity.

At a shooting gallery at the Munich Oktoberfest in the year 2014, visitors could shoot at two targets that were racist representations of black people. As an answer to critical reactions the municipal administration installed an information board, that claimed that the men pictured as targets in the shooting gallery were wearing "typical German clothes with a top hat, respectively a spike helmet". This – the information board explained – should be read as a reference to the German colonies in Africa. Overlooking that colonialism was a genuinely racist project, it went on: "The targets thereby neither have a racist background nor a racist motif. They're to be interpreted exclusively in the historic colonial context."

### Layers

The Layers offer different approaches to theoretical discourses about colonialism and racism.

Colonialism was not a unique event, not a clearly defined era, not a geographically limited phenomenon. Colonialism was and is a global system of domination by a power that culminates in the subjection and exploitation of others. It is a phenomenon deeply ingrained in both the colonizing and colonized societies – in social, political and economic relations, in laws, decrees and administrative processes, in architecture and monuments, in our mindsets and our actions. This colonialization renews itself constantly so that it has survived until today. At the same time, it is being superseded and subverted by decolonizing processes and practices. Decolonizing means uncovering the remnants and traces of colonialism in minds and societies. Decolonizing means liberating and reconceptualizing, i.e. actively discarding the colonial and racist world views, modes of thinking, practices and privileges that we have adopted both consciously and unconsciously. Decolonization is therefore at once a process and the goal of that process.

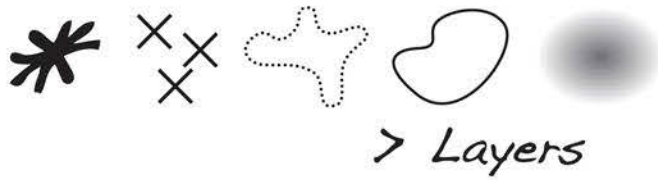

>decolonize!

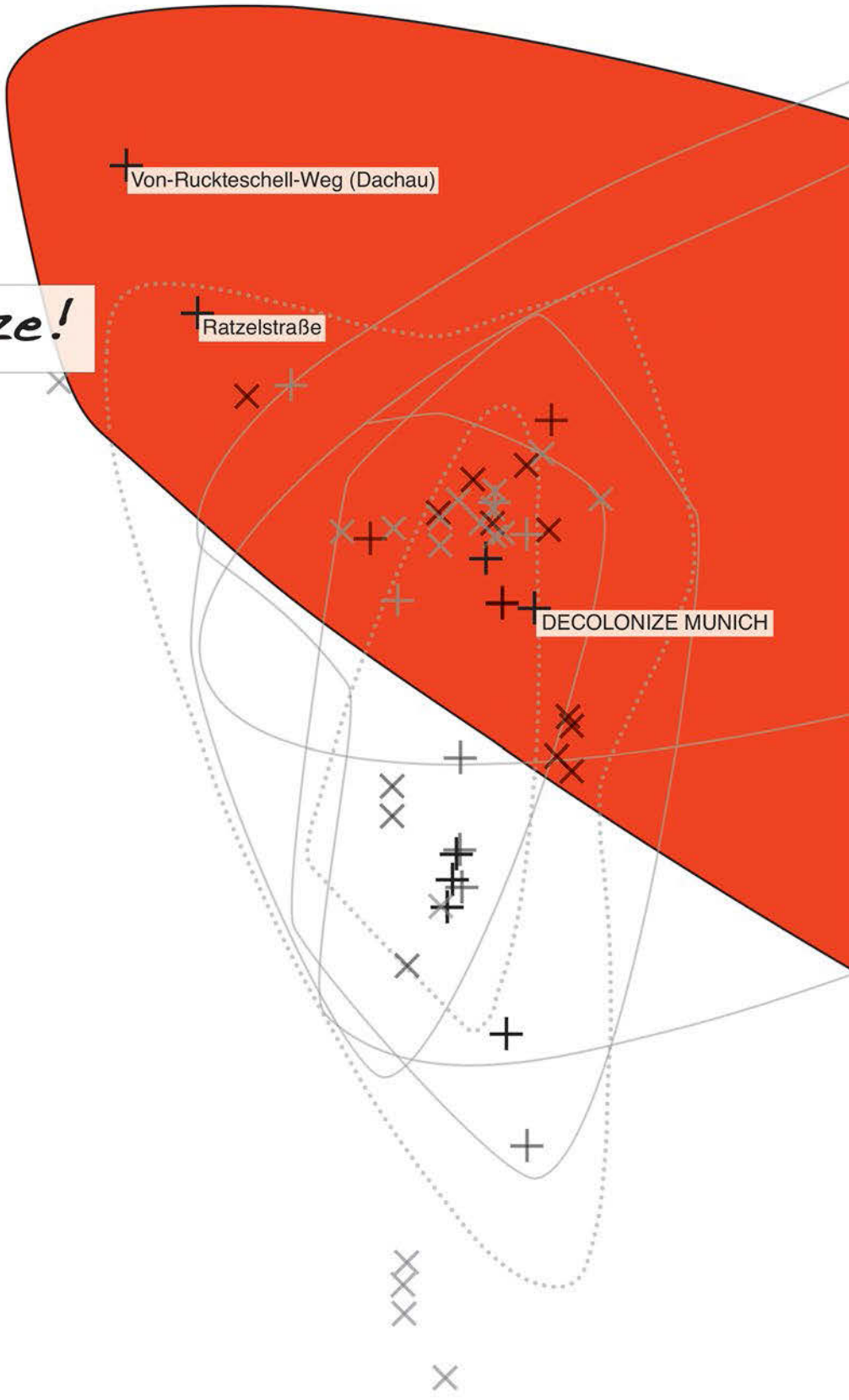

Von-Ruckteschell-Weg (Dachau)

Ratzelstraße

DECOLONIZE MUNICH

x

x x

x x

x



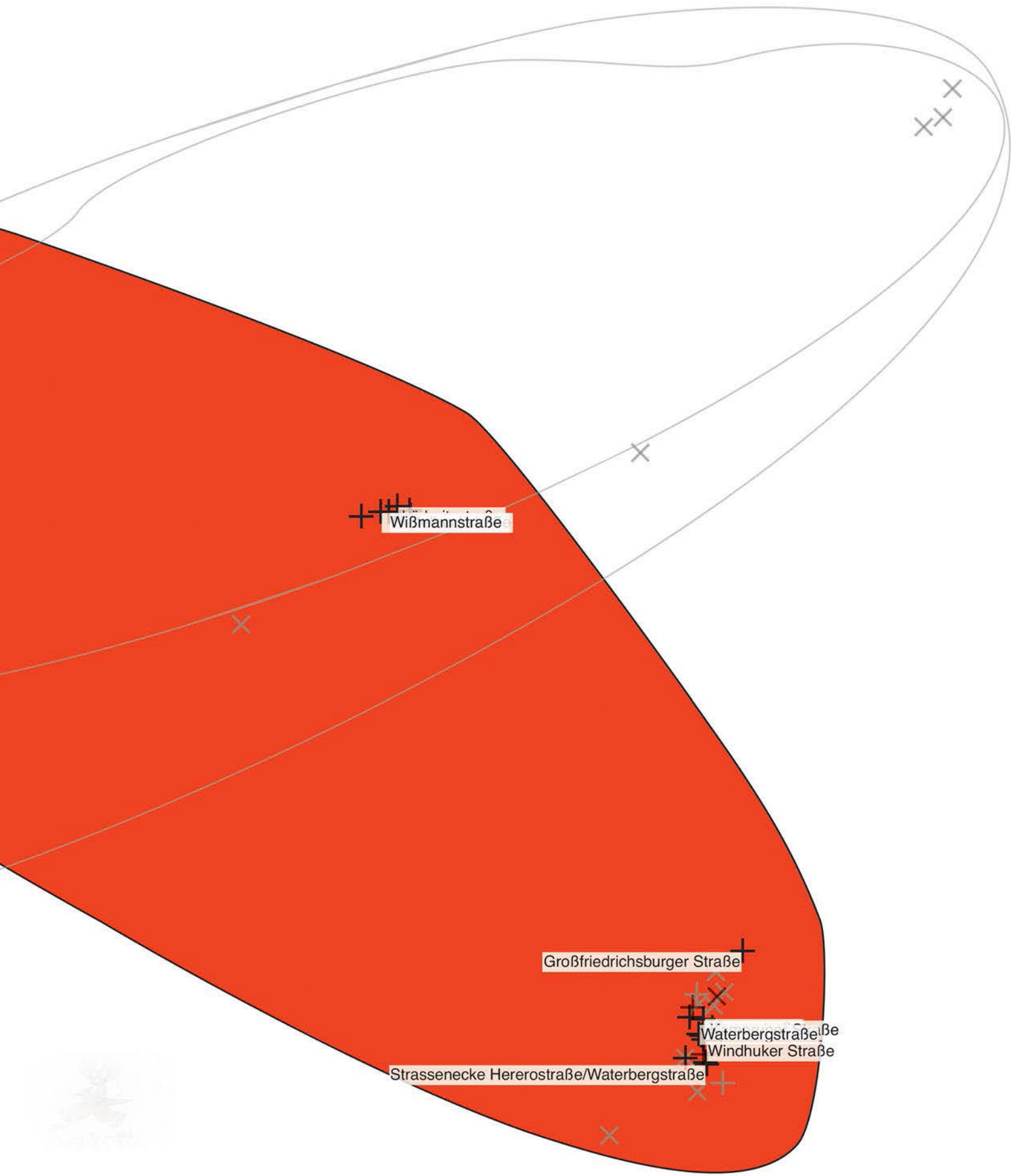

Wißmannstraße

Großfriedrichsbürger Straße

Waterbergstraße

Windhuker Straße

Strassenecke Hererostraße/Waterbergstraße



# Open-Source Aerial Imagery as a Critique Tool

## The Extractive Geopolitics Project

Imaginando Buenas

*Controlled burn / 2003-2013 / Guayaramerín, Brazil*

*10°51'21"S, 65°30'39"W*



2003

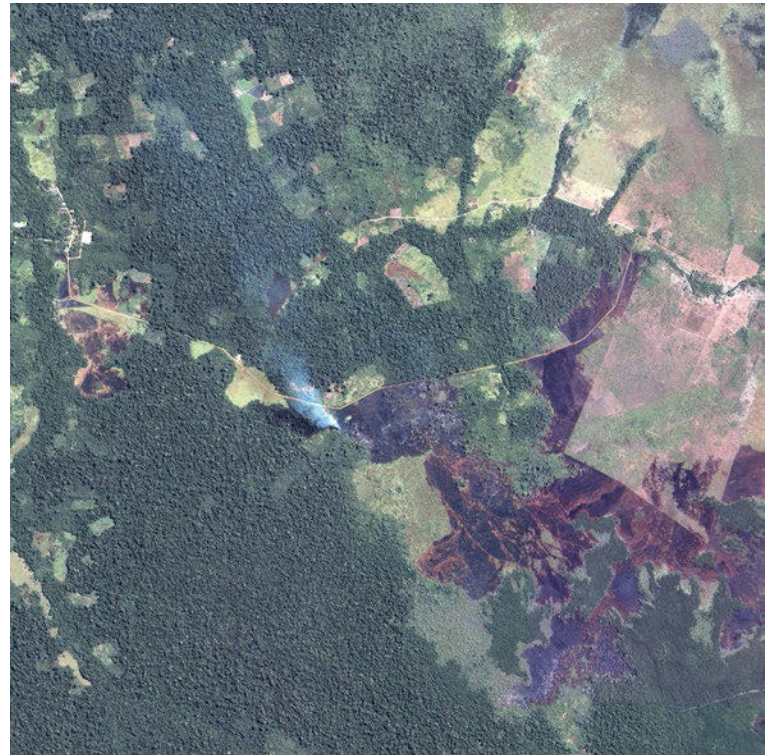

2013

Imaginando Buenas is a multi-disciplinary collective founded in 2008 and based in Montevideo. It is interested in and working with a wide range of topics from politics to design, objects to territories, music and visuals, friendship and love.

The origin of this project can be traced back to our fascination with satellite imagery, mixed with both the intrigue and indignation caused by the brutal exploitation of the face of the earth. It is too often that we are told about the impact of extractive industries and how they affect natural resources, but we rarely know its scale or location or even notice the context in which they are placed. Discussing this issue we realized that the massive transformations we knew were happening on our planet could be searched for and found in an almost playful way: The use of open data aerial imagery and the possibility to navigate the earth is now accessible to everybody.

With all this in mind, we started the hunt for globally dispersed alterations of the earth. We looked for projects that had shaped the biosphere radically in a short time span – mining industries, energy-harvesting projects or even large crops – through multiple sources – newspapers and blogs to mining conglomerate portals – which lead us to the most diverse spots on the planet. Our final goal was to list these projects, choose among the various ones we found, and finally merge the information on screen into large-scale printable images forming a canvas that was otherwise impossible to see.

The final products are 5 diptychs, one for each of the megaprojects chosen, consisting of two 85 cm by 85 cm high-resolution images, taken directly from publically available satellite imagery (Google Earth) and processed with a computer-aided design software plugin called PlexEarth. These images of approximately 20,000 by 20,000 pixels had the exact same point of view but with an average difference of seven years in time in order to show the transformations on site by comparison.

The result is dramatic: It exposes the brutality of human environmental impact. Among the sites there is a center pivot irrigation system in Australia, a controlled forest wildfire in Brazil, a coal mine in Mozambique, a hydroelectric dam in Iran-Azerbaijan and a lignite surface mine in Germany. It was our intent to show a territorial diversity that could emphasize the phenomena as global and not being relegated to resource extractions in developing countries or advanced northern industries.

These canvases were first exhibited at the Facultad de Arquitectura de la Universidad de la República and later in a collective exhibition called *Perfiles Políticos* (Political Profiles) at the Centro de Exposiciones Subte in Montevideo.

It is quite interesting how popular and accessible this tool has become in recent years and, with it, the capacity to raise consciousness and awareness: What could be done in secrecy or out of reach in the past can now be put in the center of the public eye. In this sense, there is a huge potential for both investigation and critical analysis that could empower citizens to mobilize and take action on what is ultimately the future of a collective and global resource: our planet.

#### Illustrations

all images of this article: © Google, DigitalGlobe.

*Center pivot irrigation, Karijini National Park, Australia*

*22°33'26"S, 117°59'25"E*

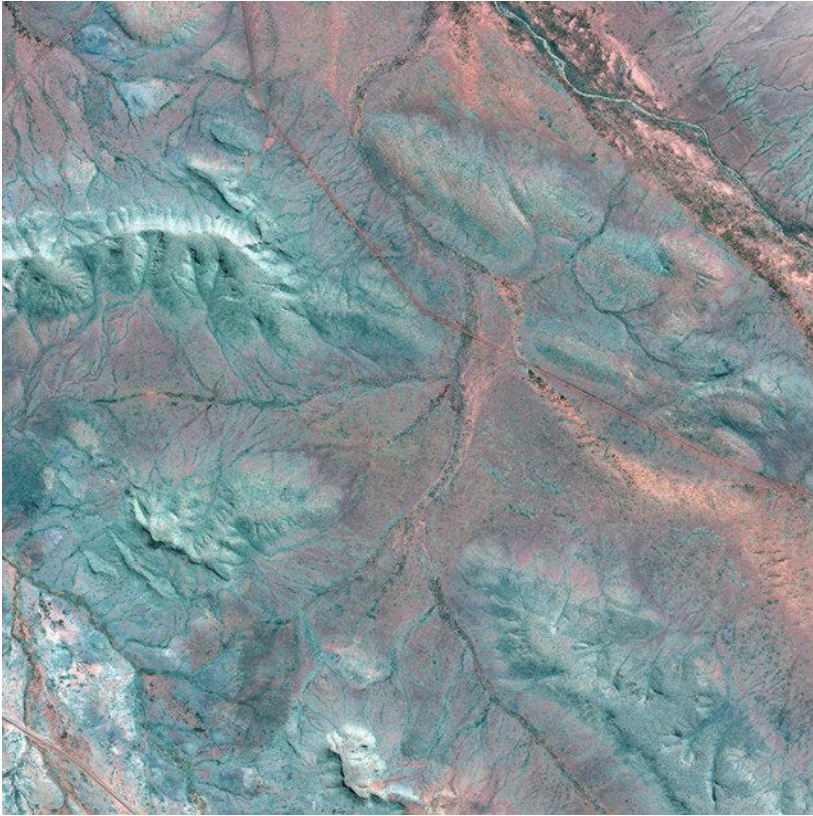

*2010*

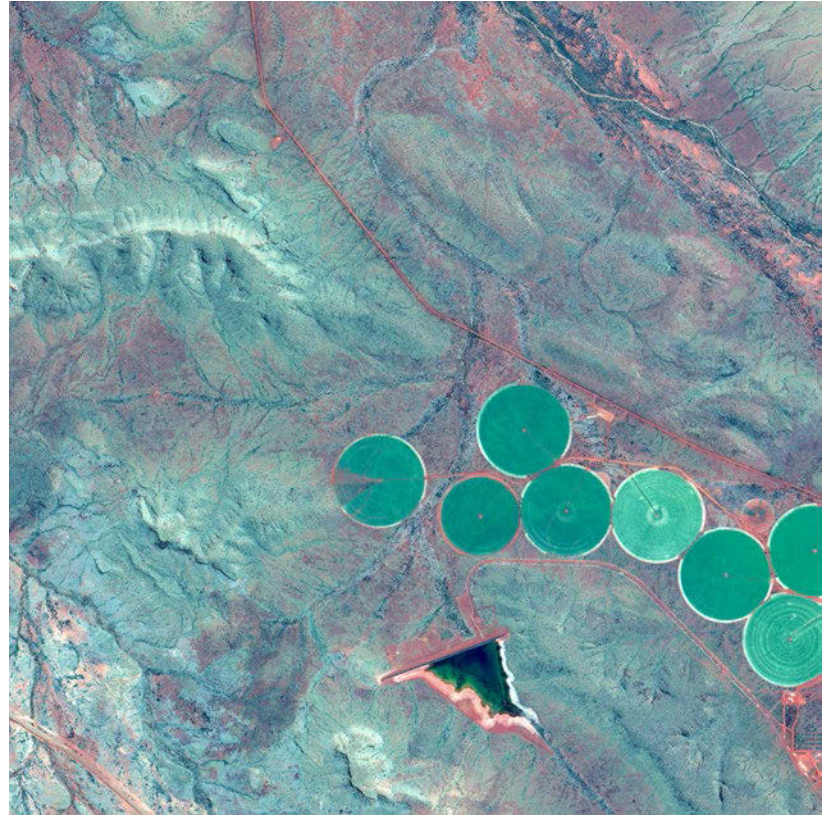

*2014*

*Lignite surface mine, Grevenbroich, Germany*

*51°02'37"N, 6°32'10"E*



*2000*



*2014*

*Hydroelectric dam, Iran-Azerbaiyan*

*39°05'28"N, 45°24'08"E*



*2007*



*2009*

*Coal mine, Benga, Mozambique*

*16°10'17"S, 33°40'25"E*

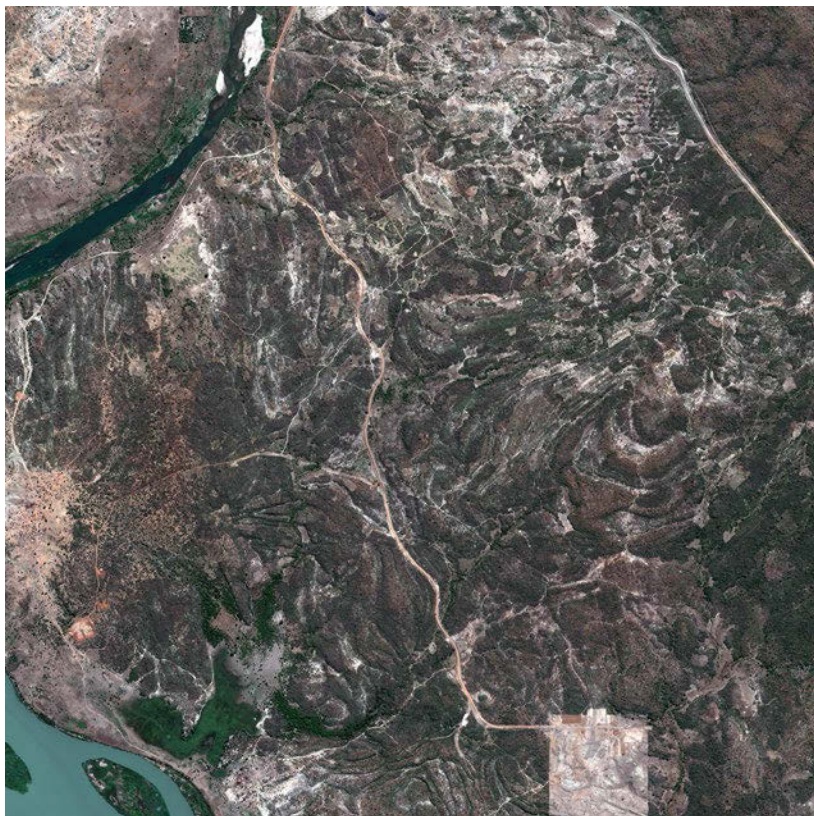

*2010*



*2014*

# You Must Buy before You Can Fly

## The Airport Malls

Philippe Rekacewicz

visionscarto.net



The following maps are the result of a long-term observation process that I made in many airports mainly in Europe. At the same time they represent a symbol.

### The Observation Process

The maps show how the general public, and specifically the passengers, are moving in a space carefully designed by an "invisible" force. By this I mean people in power and in charge to organize the logistics and flux of things, planes, cars and people inside public buildings. The general public usually knows little about it unless it would implement a long-term research project with observations on these spaces in order to evaluate the changes. The collection of maps (that could well be an animated map) are meant to visualize an invisible process: Bit by bit the passengers' free will and freedom of movement is taken away in order to make them more willing to spend money for goods, such as expensive food and drinks (for the anecdote: In many airports, after the security check, you can find anything – millions of bottles of vodka or cigarettes – but not the shadow of a diaper if by bad luck you forgot them at home and you travel with two small kids). The maps also show the progressive reduction of the "possible public space" for the public. This space will finally force the public to move into a fully organized commercial environment. Eventually, I want to propose a methodology of observation of spaces and territories to be used by people, the public, passengers, users, in order to "reclaim the streets" and, in this case, to reclaim the fair use of their public spaces.

This requires a pretty strict and disciplined approach, which can be considered in two phases.

The first phase is purely a research initiative. Observing and monitoring a location and its evolution is a multi-parametric analysis that needs to envisage both time (vertical vision) and space (horizontal vision). A location changes with time, at a more or less fast speed, and gets organized differently according to the "need" we suppose the "sponsors" have identified as necessary. This means that the observation process is to be considered an initiative of deconstruction: It is all about evaluating the changes along the observed period and detecting the hidden intentions that lie behind these changes (why have they done this, changed that, placed this barrier here instead of there, etc.). The observation process also has to be backed up with a set of interviews with the key actors responsible for the infrastructure: architects, shop managers, airport authority and state officials responsible for technical aspects. All these actors should be asked the same fundamental questions so that the answers can be compared and interpreted. The second part of the interview is freer and more flexible and relates more to the individual (feelings, personal opinion, area of competence, wishes, interests, discomfort, etc.).

When this research phase is done and analyzed, the second phase consists of live tests done on actors and spectators and experimenting with the results: It consists of invading the field with actions to resist the process of public space grabbing, for example. Another important part is publicizing the issue to the media with maps and narratives in order to alert passengers and to launch "participative mapping projects" with them. This could challenge the involvement and impact of the main actors on people, airline

companies, social evolution, consumption society, and ultimately the environment and climate.

The proposed methodology is rather typical for a "radical cartography" approach to a phenomenon. First: data collection, visualization and analyses, finding gaps as "abnormal" situations; second: direct action in the field, on the space itself, involving the actors and spectators live in an "act of resistance". In other words, a process of linking information and action, or "providing the knowledge" and "implementing the resistance".

### The Symbol

At the end, these maps describe a process that more and more deprives the public of freedom of movement while reinforcing control and surveillance. This is being imposed on society without consent. A sort of "rape" of our freedom. I wanted to cartographically ring a bell...

### Everywhere – in Post Offices, Stations, Airports and Streets – Public Space Is Being Privatized and Pedestrians Are Being Diverted through Commercial Spaces

A few years ago I was at the recently renovated Kristiansand-Kjevik airport in Norway. My flight was delayed, so I looked around for a place where I could have a drink with the people who had come to see me off. But the café was on the other side of the security control. An hour went by with no plane, no news – and no information desk. I would have had to go to the boarding gates in order to find out what was happening, but the door that used to lead to the gates was closed. So I asked a security guard at the entrance to the duty-free shop how to reach them. He said I would have to go through the shop. I explained I was just going to find out what was happening, expecting I would be able to come back the same way. He said that would not be possible: If I went through the shop, I would have to go through customs again.

Instead of going directly down a public corridor to the gates, I had to walk through a shop filled with toys, perfumes, chocolates and bottles of gin. The terminal used to be open-plan but was now divided into three sections, with access from one to the next strictly controlled.

The next month, I found out on the tarmac that my two-and-a-half year old son had filled his pockets with packets of sweets and a bottle of Chanel N° 5 he had picked up in the duty-free shop that all travellers had to pass through to get to the boarding gates.

These incidents were the inspiration behind the Duty-Free Shop Project and investigating the novel strategies for the organization of space and foot traffic which are changing the nature and purpose of public spaces. At European airports I observed movements, objects, attitudes of airport staff, the decor, lighting, design and signage, and drew maps to explain the changes and their significance.

Those responsible for the changes are the airport authorities, the transport ministries and the companies that manage the commercial spaces and airport services. It's a theatrical production: They cast and train the stars and the extras: security guards, duty-free shop staff, airline ground staff, customs officials, police – and travellers; they collaborate on the interior layout of the terminals; they decide on the decor, the lighting and fields of vision. Which

areas should be "open" and which "closed"? Everything is designed to bring passengers to the point where they are ready to buy.

The airport authorities deny any involvement in the changes. Jo Kobro, former head of media relations at Oslo Airport said, "The shop managers decide their selling strategies individually" (while being unable to look me in the eye), but the stores make money and the airport authorities get a cut.

### **Retail Therapy after the Ordeal**

The vulnerability of civil aviation became clear in the 1950s, after two aircraft had been blown up over North America by bombs in their baggage holds, in 1949 and 1955 (the bombers' motives were marital infidelity and life insurance fraud). However, for nearly half a century longer, airports were relatively open places where families came for an exciting day out, to stare at VIP passengers and daydream in front of posters advertising exotic destinations.

The bombings of UTA (Union des Transports Aériens) flight 772 in 1988 and Pan American Airlines flight 103 in 1989 led to stronger surveillance and security systems, but the 9/11 attacks marked a new era: Air travel suffered a slump that lasted until 2005, and airlines as well as airport authorities faced an unprecedented crisis.

Many airports and airlines initially received massive public subsidies, especially in North America, but airports were soon told to cover their own running costs. This was all the more difficult, because the taxes on air tickets had been significantly reduced, or even temporarily waived, in order to stimulate growth. Airport management was outsourced to private, public or mixed public-private enterprises.

The new managements' solution was to turn airports into commercial spaces. Some became little towns, complete with supermarkets, duty-free shops, parking garages, hotels, business and conference centres. The airports took a cut based on turnover (the figures are not published).

After 9/11 the airports also revised their approach to surveillance and security. The "outside world" is now strictly separated from the "inside world", and crossing from one to the other means being scanned, searched, patted down and dispossessed of any object that presents a "threat" (including a bottle of mineral water).

Airports have become hyper-commercialized and hyper-securitized spaces, in which travellers are held prisoner. Management companies have reorganized the flow of passengers through terminals, turning them into laboratories in which subtle spatial modifications are tested. The goal seems to be to determine how to make the most money from passengers, who are manipulated and channelled through specially designed zones filled with tempting merchandise.

Everything in the "inside" space is regulated, from the freedom to gather in groups to photography. No complaints or choices of route are allowed. It is a capitalist and monopolistic economy, in which just a few multi-nationals run hundreds of shops, restaurants, bars and airline ground services, contracted out to local operators. The

right to information is denied: Notices mentioning "passenger rights" are placed where they are least visible, in dark corners or behind pillars. Advertising based on themes such as dreams, travel and sex distracts attention from the way public space has been hijacked.

The first step is to disorientate passengers. Security guards and duty-free shop staff wear almost identical uniforms. Shop staff are responsible for keeping order in and around the shops; security guards act as touts for the shops. At Kristiansand-Kjevik, a guard pointed with authority to one of the two doors behind him, so nearly all the passengers off a flight from Copenhagen were diverted into the duty-free shop. Nobody saw the door next to it, which leads directly to the baggage claim area.

### **Directed to the Shops**

The signage uses the same graphic codes to direct passengers to the boarding gates and to advertise the shops, so passengers think they are getting directional information, but they are actually reading an advertisement. They think they are setting off on their journey, only to end up in the shops. At London's Gatwick Airport, the main toilets are inside the duty-free shop and are treated as a customer amenity, not a public resource. To board a plane at Brussels, passengers must pass through shops – enforced retail therapy after the ordeals of check-in and security control.

Less than a decade ago, airport commercial spaces, where everything has a price tag, were separate from free public spaces, in which everything is free. Today these spaces have merged, and in London, Oslo, Bergen and Milan, "free" public corridors have simply disappeared. The two spaces sometimes exist side by side: the carefully designed commercial world, brightly lit, filled with merchandise, and with colour schemes dominated by brilliant white, bright yellow and red; the public spaces, where passengers may sit down – if they can find a seat, often a greenish grey. In airports such as Copenhagen, many seats have been removed to make room for restaurants and shops. These uncomfortable zones offer no frills: They are not seen as useful.

These changes affect only a few (only 10-15% of Europeans fly regularly), but they have prefigured what is now happening in other formerly public spaces, including rail and underground stations, whole streets and town centres. Paris' Saint-Lazare station has become a shopping centre; at Bodø, in central Norway, the whole of the main street has been privatised.

This text has been written inside the Oslo Airport. While travelling on one day (I often travel through this airport), I realized that the public corridor leading to the embarking gates had been closed. This poem is evocating the slow but powerful changes going on in our common public spaces. Some invisible people are strategically organizing this space in which we evaluate, walk, dream or which we use just to go from one place to another. They are – in a way – forcing you into environments you would not enter spontaneously on your own, and I felt this was frightening. This poem aims to remain a symbol of a very specific form of a growing totalitarianism: being forced to consume.

*Translation by Charles Goulden*



An airport is a zombie zone between two worlds.

Not Never Never Land.

Just Nowhere.

You get temporary citizenship  
between check-in and boarding.

They lure and bully you into a dreamscape  
of corridors and walkways, and the local paradox  
between tightly closed security and wide-open shops.

They confuse you, too.

Everything is signposted and labelled,  
but you still don't know where you are;  
everything is there to tempt you, luxury goods and foods,  
but you feel totally deprived, and trapped.

The retail spaces are seductive,  
yet you didn't choose to shop here.

You didn't choose to be here.

They are controlling you, guiding you, harassing you:

Will you be able to resist a purchase?

2005

# OSLO GARDERMØEN

AFTER THE HUSTLE AND BUSTLE OF THE OUTSIDE WORLD, IT WAS GOOD TO REST IN THE CALM AND SILENCE OF THE COMFORTABLE, ULTRA-MODERN DEPARTURE LOUNGE

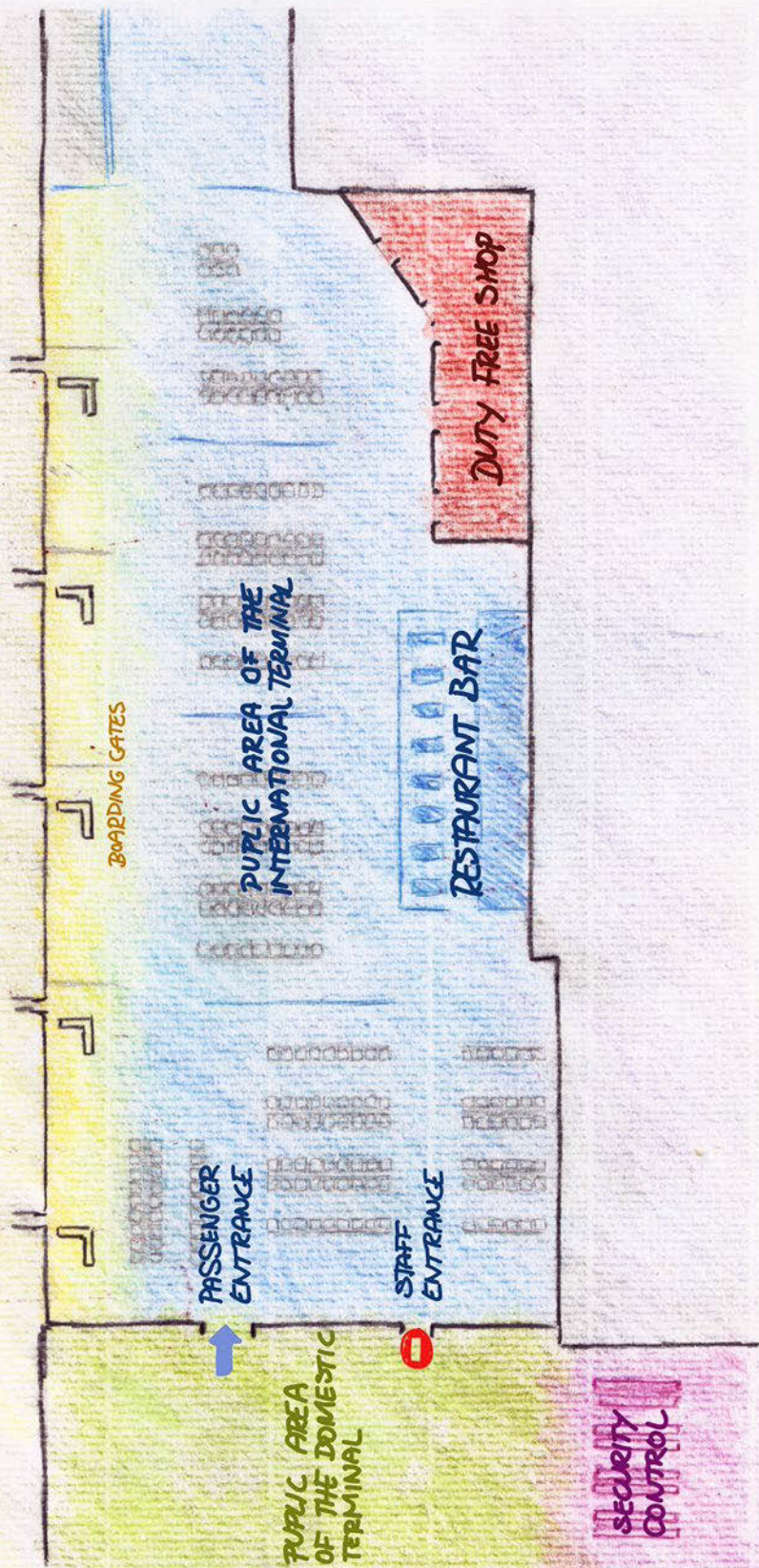

2006

I SEE! THE AIRPORT MANAGER WAS PROUD OF HIS CONCEPT: A CORRIDOR -SHOP WHERE EVERYTHING CAN BE GRABBED JUST BY REACHING OUT LEFT OR RIGHT

THEY ALSO INVENTED A WALL OF TRUNKS. SOMEWHERE, THEY HAD TO FIND A PLACE FOR IT





2007

"A PUBLIC CORRIDOR?"  
SAID THE AIRPORT SPOKESMAN.  
"ALL RIGHT, IF YOU MUST"

YOU HAVE A CHOICE: SQUEEZE PAST THE  
TROLLEYS, OR RUN THE GAUNTLET OF CIGARETTE  
CARTONS WARNING OF A SLOW AND PAINFUL DEATH

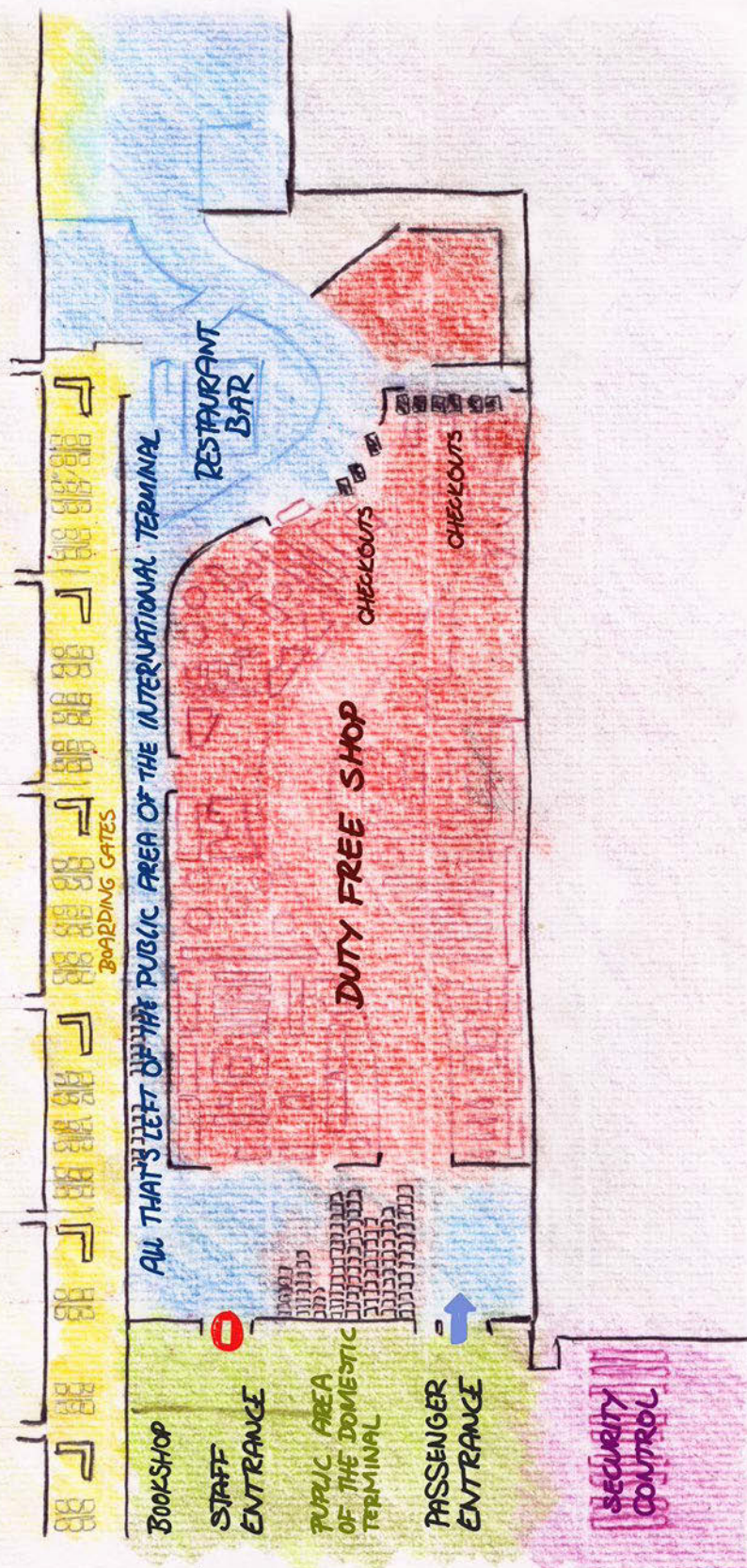



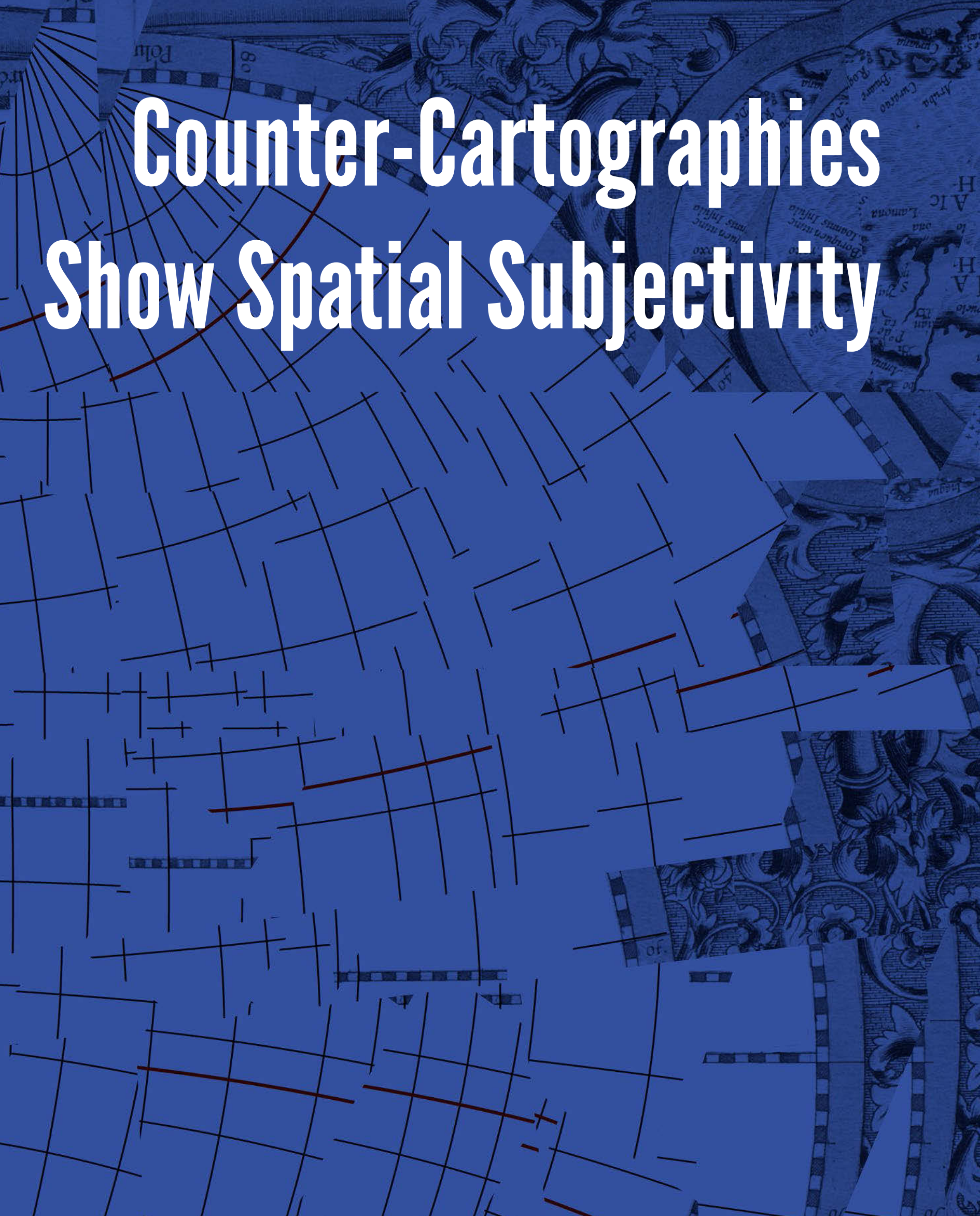

# Counter-Cartographies Show Spatial Subjectivity

# Visualizing the Counter-Narratives of Port Said

An Experiment of Mapping Social History

Nermin Elsherif

[nerminelsherif.wisite.com/othermaps](http://nerminelsherif.wisite.com/othermaps)



History and maps are both social constructions produced by people who attempt to normalize their arguments. But what happens when this process of production becomes collaborative? And when arguments reflect the counter-narratives of people, and not authorities? What happens when primary sources of history are used instead of their interpretation of historians? Could this contribute to creating a counter-map challenging the official representation of depicted spaces, such as cities, for example?

I would like to write about an experiment of mapping the social history of Port Said. A port city that was depicted by the states which were involved in the foundation of the Suez Canal Company, the national Egyptian Survey, as well as different tourist guides. Each of these maps echoed the interests of its makers and commissioners. Although the geography of the city is always present in the residents' stories, their songs, and even their everyday expressions, these bottom-up narratives have never been mapped. This mapping experiment was part of the History Workshops of Egypt<sup>1</sup> activities that took place from the 27<sup>th</sup> to the 30<sup>th</sup> of January 2016. The goal of the workshop was to train young artists, activists and researchers on the methods of social history. The goal of the map was to visualize their findings in the form of a map which then remained in Boulevard, one of the most active cultural venues of the city. The map-makers worked on collecting primary sources of history about the city, researching in newspapers, on postcards, in songs, through personal archives and conducting oral history interviews with the residents. Collaboratively they redefined the basics of the map, deciding on the legend, the scale, the extents and the methods of inscribing history into the map.

Inspired by the community map in the Fietas Museum of South Africa, the map serves as a board of collective memory of Port Said residents. After the map-makers had set its foundations and visualized all the collected narratives, they invited the city residents to the event, celebrating the end of their research workshop where the map was first introduced to the public. The map was designed to offer the residents a space to share and visualize their memories by adding their own photos and testimonies regarding the five historical periods. Up to my knowledge, the map remained a central part of the cultural venue to which other youth initiatives have also contributed until the venue was closed by the government.

### On Scales and Extents

Knowing how the "consistency of scale" would be a limitation of representing this city, the map-makers decided to use three maps of different scales: a world map, a map of Egypt and finally a map of Port Said. Events were thus indicated in their geographic location and elaborated upon in the corresponding timeline panel. The goal was to recite a counter-history of the city from different perspectives: Egyptian peasants who were forcibly brought from Upper Egypt to dig the Canal in 1859, those who arrived from Europe between 1914 and 1918 searching for a safe refuge and hoping to earn their living, and many others who started in one point of the world and ended up in this city or vice versa.

The timeline panels show how the density of multiple events in the year of the Suez War (1956-1957) occupy an area equal to the calm fifty-five years of city construction (1859-1914). The experiment of visualizing time through the social history of the people showed how a few months were "louder" than several years. The timeline includes images, scans from the residents' personal archives, memoirs of travelers, Simsimiyya<sup>2</sup> songs and quotes of the members of civil resistance who were interviewed. It was put together from the entire material produced and used by the participants of the workshop.

### On the Legend

In order to tie together counter-narratives of the city, the legend for this map had to represent the multiple sources from which these narratives were taken. With threads of five colors representing themes or sources of social history (personal archives in blue, state narratives in black, built environment in white, flow of people and goods in green, and finally cultural history seen in songs and arts in red) different spaces were tied to one timeline. The pins were used to allocate the threads in the geographic locations, and the temporal panel was color-coded in order to represent different time intervals. Although it sounds like a complex system of coding, it evolved naturally through the participants, as they worked to project the stories they had collected within their geographic and temporal contexts. Just by following the blue thread representing a personal narrative of a migrating family, tied to a green pin signifying the years of war, you can understand how and why the family moved.

The legend of this map became a system for narrating each story without the dominance of one over another. This resulted in a map of intersecting and overlapping pins and threads that represented the plethora of multivalent voices behind all the different stories of the city. Nevertheless, this also made it difficult for onlookers to see the overall map behind the threads. This "web" reflected the complexity of the narrative in a reduced visualization. As any map, it is a reduction of a complex landscape.

### Reading the Map

The map can be read both geographically and chronologically. In this context, I would like to write about the chronological reading, since it serves in creating a holistic overview of the map. However, a geographical reading is always possible if the reader wants to follow the history from a specific location within the city.

In the first interval, most of the used materials were either postcards depicting the wide boulevards and arcades of the European Quarter, stressing its cosmopolitan nature or depicting the port and its vast steam ships.

In the second interval, more human faces appear. The photographs and scans from the personal archive of a naval captain who worked in the Suez Canal Company as a ship guide dominate the timeline with spatial reference to the port on Port Said's map. The places he travelled to in Cairo, Alexandria and Paris also appear on the world map. The dominance of the blue threads representing

personal archives in that era shows the intensity of the social life in this city during the interwar period and prior to the Suez War of 1956.

The third interval is the richest in stories and images, even though it represents only one year of the Tripartite Aggression of 1956. Here the dominance of the blue threads (personal stories) can be clearly seen. Almost all of the images within this interval came from Per Orlow, a Swedish photographer who covered the war period. His photographs – as the very few visual documents of the war – document the horrors and the resistance of the people. This interval also included articles and graphics from flyers and publications printed by the popular resistance at the time. Quotes describing the scenes of the war from figures of the popular armed resistance were pinned to their locations in space and time as well. By following the threads, the map shows how the whole city became a terrain of war.

The fourth interval only contains sounds of the city. Since no visual material of the city was found during this research, it is completely made up of the quotes and songs of residents speaking about their deportation as a result of the wars. Between 1957 and 1975, the city witnessed a constant state of unrest. All that remained in the city were the songs of the popular resistance and the images of the defeat.

The last interval represents a new image of the city after the peace treaty with Israel and the declaration of the city as a free zone. The green threads start to emphasize new borders on the map, designating the extents of the tax-free goods in the city. The interval on the timeline shows mostly advertisements for cars, households and clothes. It also shows pieces of news about the tax dodgers. During this period, the post-war housing projects, which extend to the West of the city, were constructed. By looking at the timeline, one could notice the low number of threads starting from this vast urban region. The few threads indicated that this was not very present in the collective memory of the city when compared to the two old districts of the Arab Village and the European Quarter.

By comparing the five different time intervals to each other and taking the three spatial scales of the maps into consideration, a more holistic understanding of the research conducted during this workshop can be developed. The map gave us the chance to realize the silent spaces of the city, to which no memories seemed to be tied. It showed us the centers of struggle and contestation, of agony and loss, of pride and nostalgia, and also of a capitalist economy taking over.

## A Counter-Map?

At this moment it seems worth it to take a step back from the map and question whether it can be considered a counter-map or not. The map – in terms of content – was an attempt to visualize a counter-history of the city; a history that is constructed through material from personal archives, songs, testimonies and primary sources. Moreover, the process of making the map by replacing single authoritarian figures with a group of participants from different backgrounds to collaboratively trace their subjects of research in place and time is a counteract in itself. It defies the normative process of map-making. This results in several counter-aspects of the map, from the legend that shows the multiple sources of the social history instead of official boundaries to the scale that became absolutely inconsistent, putting together three different scales of the world, the country and the city. By the end of the mapping process, the map appeared to be covered with a complex network of colored threads and pins that made it difficult for users to decipher and understand its contents when viewing it for the first time. However, this complexity was also described by the map-makers who, by looking at the map, realized how difficult it is to visualize social histories, probably due to the difficulty or even the impossibility of the task. It is hard to say whether this experiment is a counter-map of Port Said or not, but it is definitely an attempt to visualize counter-narratives and to defy the normative format of maps. This experiment shows that it is possible to design a map of multiple narratives that can be read in multiple ways: geographically, chronologically, and thematically.

### Endnotes

1. The History Workshops of Egypt is an initiative founded by the social historian Alia Mossallam who worked on collecting oral history in different regions of Egypt from Nubia, to Port Said, Alexandria, and Cairo. More about the initiative, its workshops and outcome can be found here: [historyworkshopegypt.net](http://historyworkshopegypt.net)
2. A string instrument that came to Port Said from Upper Egypt with the workers who were forcibly brought to dig the canal. This instrument turned into a music genre which is related to the identity of the city and also used as a popular method for reciting history. For more information see Mossallam (2012).

### References

Mossallam, A. 2012. *Hikayat Sha'b – Stories of Peoplehood. Nasserism, Popular Politics and Songs in Egypt 1956-1973*. PhD Thesis. London: London School of Economics.

### Illustrations

The map was made as part of the History Workshops of Egypt, along with the 17 participants and the organizers. The workshop was funded by the ACSS (Arab Council for Social Sciences).

Photographs by Youmna el Khattam, commissioned by the History Workshops of Egypt.



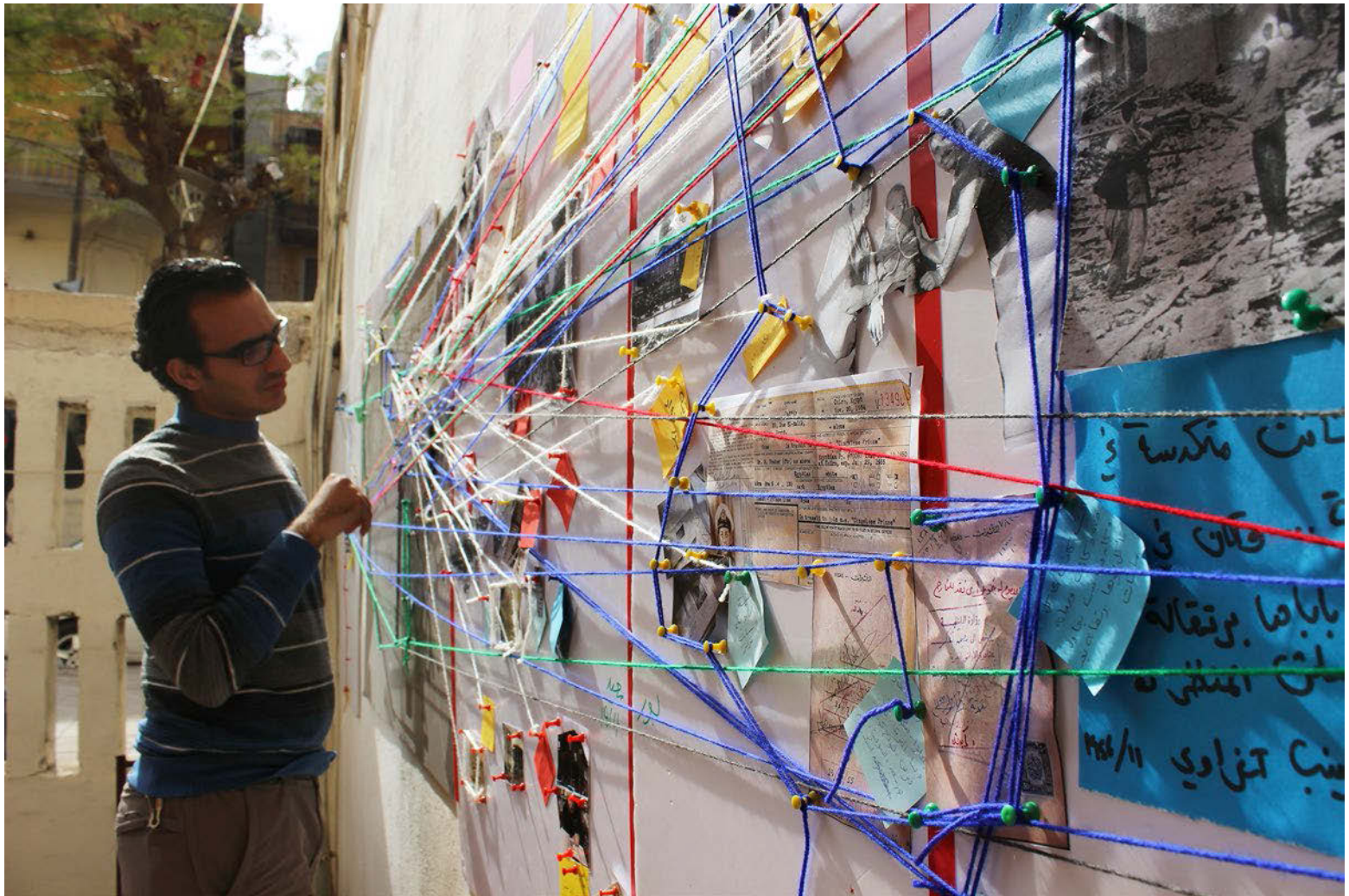

## THE COLLABORATIVE LEGEND

### THREADS:

- Blue — Personal Narratives/Personal Archives
- Black — Official Narratives
- White — Architecture
- Green — Flow of people and goods
- Red — Cultural History and arts

### PINS:

- Red — 1859-1914
- Yellow — 1945-1950
- Green — 1951-1956
- Blue — 1957-1976
- White — 1976-2002

WORLD MAP

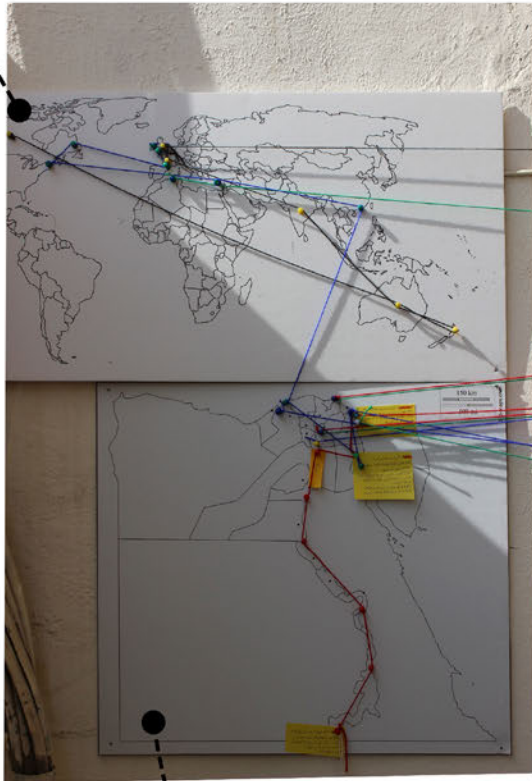

MAP OF EGYPT

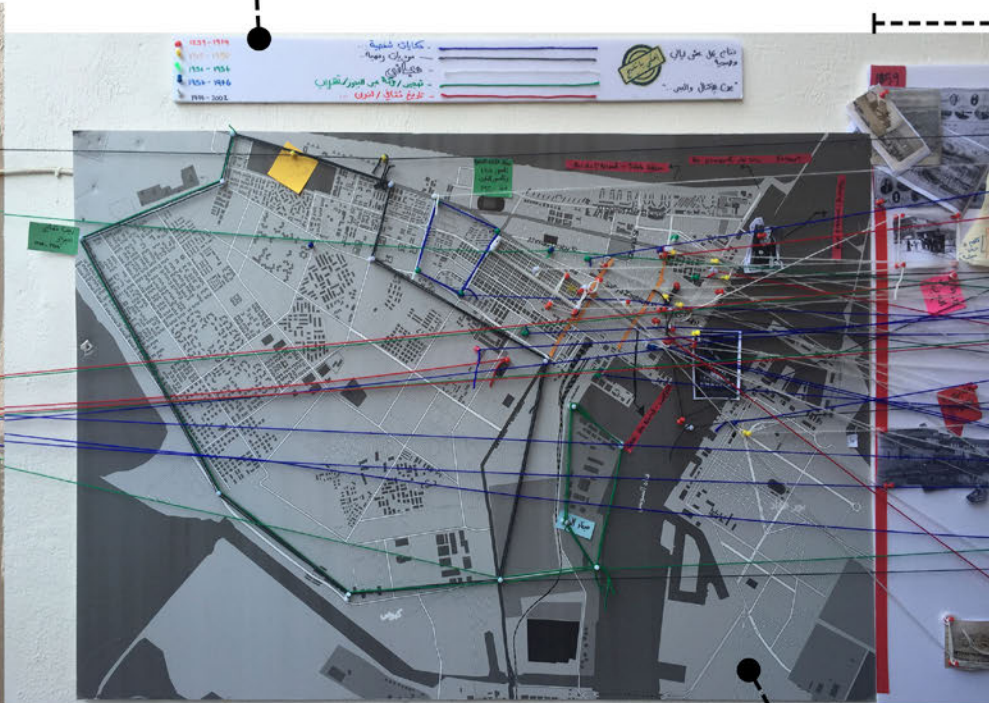

EXTENTS OF PORTSAID  
FROM OPENSTREETMAPS

55 years



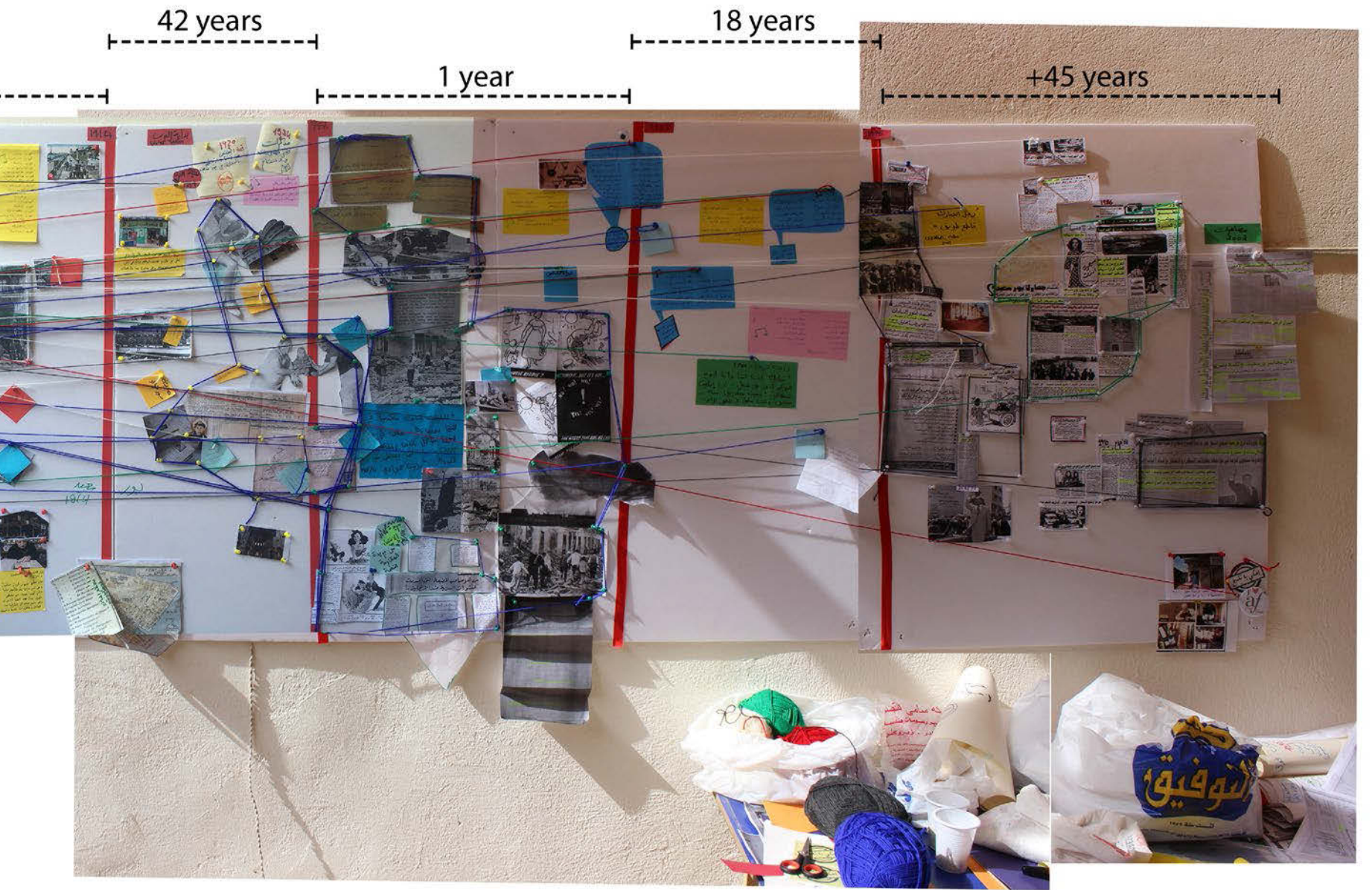

42 years

18 years

1 year

+45 years

السوفيق

# Counter-Cartographies of Exile

Sarah Mekdjian, Anne-Laure Amilhat Szary  
[antiatlas.net/en](http://antiatlas.net/en)



## From Afghanistan to France

The map presented here (see map at the end of the article) sketches a trail of exile from Afghanistan to France. It was created by H.S.<sup>1</sup>, who was seeking asylum in France when we met. H.S. attended the cartographic workshops titled Crossing Maps that artists and researchers in geography organized with other asylum seekers and refugees in Grenoble in May and June 2013.

The map's zenithal view makes it possible to understand the places and the distances involved at a glance, but it is not the only perspective that is presented. The map is also drawn from ground level, using the path pursued, and from inside the trailer behind a truck. In the frontal view, the mountains around Afghanistan and Iran break with the zenithal perspective, and so do cars, trucks, boats and an individual on the road. Returning to ground level, one perceives the space as a landscape of displacement for H.S., who represents himself in his work. This map blurs the dichotomy between the map as a grid and as a route.

The former is the result of the a priori imposition of codes that seek to depict a point of reference that is considered stable and measurable; the latter "provides a representation of the territory on which [it] is not considered independently from the practices that are deployed [...] on the contrary, it is defined within its structure by the practical engagements of those who record their wanderings there." (Besse, 2010: 7).

The map From Afghanistan to France (see map at the end of the article) presents the journey of the traveller-cartographer, using the conventions of established geography and geopolitics (the names of the countries and of the cities crossed before reaching France) but also representing the experience of the road (the material and political obstacles that have to be overcome, the hardship of being confined inside a truck, the encounters with the police...).

This map of exile is not the creation of a totalizing eye; it is also seen from below, from the walking point of view and the multiple practices and tactics used to cross geopolitical borders. In this sense, From Afghanistan to France subverts the conventional and normative maps of migrations and nation states. Embracing a point of view from the ground, this map is questioning the "commensurability of Euclidean space, [...] the scientization and regularization, [...], disciplinization of space" (Crampton & Krygier, 2006: 18).

In addition, From Afghanistan to France is not only a cognitive or mental mapping. In order to read the map, it is necessary to read the map legend (see map at the end of the article). Here the different symbols do not represent rivers or settlements; instead, they symbolise the fear, danger, police, injustice, friendship, love... encountered en route.

## Counter-Cartographic Workshops

H.S., who created this map, is one of the Grenoble residents who were invited to take part in the counter-cartographic workshops (Mekdjian et al., 2014; Mekdjian, 2016) that took place over two months, in May and June 2013, in Grenoble on the premises of the association Accueil Demandeurs d'Asile (ada-grenoble.org). This local association helps individuals seeking asylum in Grenoble to deal with the administrative procedures that affect them.

The cartographic workshops, initiated by Sarah Mekdjian, geographer, brought together twelve Grenoble residents who were seeking asylum as well as three artists, Marie Moreau, Lauriane Houbey, Fabien Fischer, and a geographer, Anne-Laure Amilhat Szary. The participants came from Sudan, Afghanistan, Armenia, Eritrea, Azerbaijan, Algeria, the Democratic Republic of the Congo and others. Some were staying in emergency shelters and hotel rooms, while others were living on the street or in squats.

## A Few Intentions of the Counter-Cartographic Workshops

The first intention was to collectively produce maps that would breach some norms of migratory representation, which generally uses arrows to indicate displacement. Maps are often the result of a territorial, static and quantitative conception of migration.

Representing movement in its qualitative, sensitive dimensions is particularly challenging. It implies to enquire the points of view of those who are displaced. In their analysis of trans-Saharan migrations, geographers Armelle Choplin and Olivier Pliez (2011) explain that many cartographic representations, mostly in the media, lead "to a vision of a smooth migratory space – in other words: where the continuous line drawings of some migration routes overshadow the political, police and pecuniary dimensions of spatial and temporal 'roughness' that mark the routes taken by migrants". It seems that the hardships, and all the experiences involved, encountered by the individuals on the trail of exile are more difficult to represent than is the measuring of the flows of individuals crossing borders.

Routes and flows are often instinctively depicted by arrows, feeding Europe's invasion anxiety: "The long strokes that depict the migration from Africa in the direction of Europe convey the image of an invasion carried out via multiple routes (the cities of Ceuta and Melilla, as well as through Libya) that are, however, rarely used all at once by thousands of migrants. Such maps make one forget that these flows are marginal with respect to African migrations and even trans-Saharan migrations. They also lead to a blurring of the terms 'routes' and 'flows'." (Choplin & Pliez, 2011).

The second main intention of this project was to open a creative space of hospitality in which one could suspend the administrative standards of the "real" and the "fake" refugee. The administrations responsible for granting the right of asylum (the French Office for the Protection of Refugees and Stateless Persons – OFPRA – in the first instance, and the National Court of Asylum – CNDA – in the second instance) seek to define what constitutes a "true story" and a "real refugee", terms that generate strong symbolic violence (Fassin & Kobelinsky, 2012). The act of seeking asylum in the signatory States of the Geneva Convention means having to undergo tests of narrative credibility that are carried out by the administrations. Every individual is asked to recount the reasons and the circumstances of the journeys they undertook. The asylum seekers have to provide a "verifiable" account that corresponds to the statutory definition of a refugee as it is defined by the Geneva Convention of 1951<sup>2</sup>. The recording of proofs is one of the conditions required for the application to be successful. While the administrations demand life stories/accounts that are "verifiable"

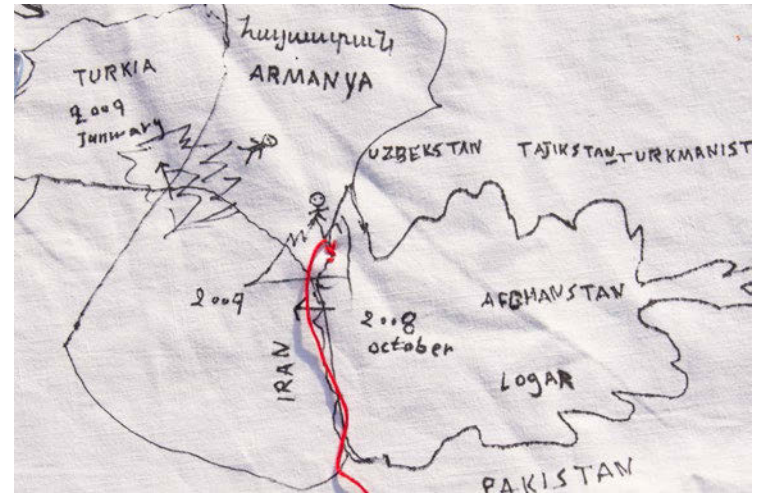
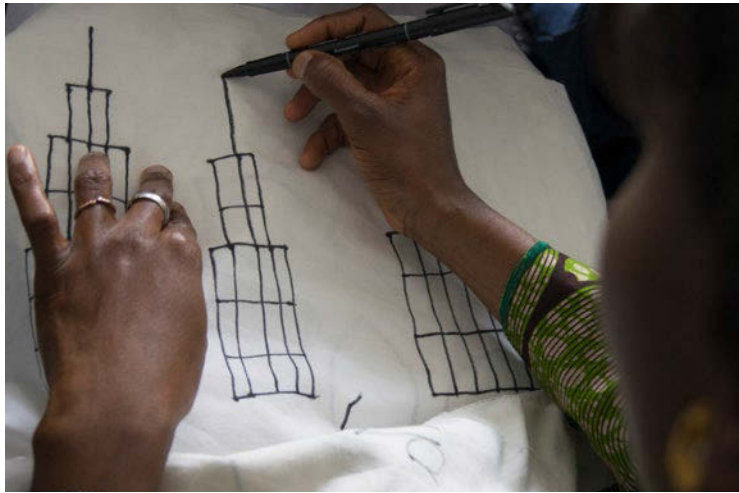

in order to approve or reject the asylum application, we seek to question the idea of "narrative truth". "Narrative truth" is itself inconsistent with the principle of narrative enunciation. According to the theories of enunciation, the act of enunciating is analysed as a set of heterogeneous linguistic and non-linguistic elements, constituted by affective, ethical and political forces. In the case of asylum procedures, telling "the true story of what happened" cannot be understood outside the political conditions of enunciation between the judges and the applicants. The politics of testimony developed by the judges and the Geneva Convention determines in great part what can be said and not said, heard and not heard. The notion of "narrative truth" also clashes with the complex process of memory production and with the subconscious, particularly in a trauma context (Pestre, 2012; Signorini, 2015). In a text dealing with the Israeli-Palestinian conflict and the politics of humanitarian protection, Didier Fassin deconstructs the very idea of "true" testimonies or narratives: "The point is [...] not to determine whether the Palestinian youth is a combatant or a neurotic, but to acknowledge that he is presented, and even presents himself, alternately as one and the other. We then seek no longer to know what his true experience of violence is, but rather, what the various ordeals of truth to which he is submitted by political authorities or humanitarian organizations, by religious officials or psychiatrists, correspond to." (Fassin, 2008: 533).

During the workshops, the researchers and artists collectively decided to suspend the categories of "truth" and "untruth". They invited the participants to draw maps dealing with exile and displacement, without the researchers or artists asking any questions about what "really" or "personally" happened.

Within this frame, Sarah Mekdjian and the participants started to work on creating a collective and common map legend, reproduced here (see following spread) and used by H.S. We collectively discussed the most significant words that could express migratory experiences. Each participants proposed several words. We translated them into different languages as the discussions progressed and eventually retained the most important ones for the collective. We then symbolised them by using coloured stickers in various shapes. The participants chose the system of symbols that they found most pertinent.

The following step of the work involved incorporating the collective map legend in the individual maps. In his map titled *From Afghanistan to France*, H.S. used the collective map legend to describe some experiences of exile.

Following the work initiated by Sarah Mekdjian, the three artists proposed other creative protocols in order to produce different forms of enunciation. The purpose was to explore how different protocols would lead to heterogeneous and polyphonic maps and discourses. Marie Moreau invited the participants to draw exilic experiences in black marker on large white sheets of fabric, which were then subsequently partly embroidered (see photographs above). Lauriane Houbey suggested to remember the voyages by means of soundscapes (audio document proposed and produced by the artist), while Fabien Fischer produced another audio document with the participants on the urban life in Grenoble. Nasruddin Farouk Gladeema created a three-dimensional map in clay entitled *The World is Stopping Us* (see photograph on previous spread and photograph to the right). *Cartographies Traverses/Crossing Maps* is the name of the visual and sound device composed of all these creative cartographic works.

*Cartographies Traverses/Crossing Maps* seeks to critically engage views of migrations: in the rubbing out, the silences, the gaps, the changes in perspective from the sky to the ground, the forks and the hesitations one catches a glimpse of the movement of memory that these maps convey. The maps are neither true, nor false. *Cartographies Traverses/Crossing Maps* figures trajectories of memory; it extends an invitation to read maps and accept the possibility of losing one's bearings in them.

*Translation by André Crous*



### Endnotes

1. The use of the initials has been decided by the person itself.
2. Article I - Definition of the term "refugee". For the purposes of the present Convention, the term "refugee" shall apply to any person who [...] owing to well-founded fear of being persecuted for reasons of race, religion, nationality, membership of a particular social group or political opinion, is outside the country of his nationality and is unable or, owing to such fear, is unwilling to avail himself of the protection of that country; or who, not having a nationality and being outside the country of his former habitual residence as a result of such events, is unable or, owing to such fear, is unwilling to return to it" (Geneva Convention, 1951).

### References

- Besse, J.-M. 2010. Cartographies. *Les Carnets du paysage*, 20: 5–9.
- Choplin, A. & Pliez, O. 2011. De la Difficulté de Cartographier l'Espace Saha-ro-Sahélien. *Mappemonde*, 3(103). [mappemonde.mgm.fr/num31/intro/intro2.html](http://mappemonde.mgm.fr/num31/intro/intro2.html), 13 January 2018.
- Crampton, J.W. & Krygier, J. 2006. An Introduction to Critical Cartography. *ACME: An International Journal for Critical Geographies*, 4(1): 11–33.
- Fassin, D. 2008. The Humanitarian Politics of Testimony: Subjectification through Trauma in the Israeli–Palestinian Conflict. *Cultural Anthropology*, 23(3): 531–558.
- Fassin, D. & Kobelinsky, C. 2012. Comment on Juge l'Asile. L'Institution Comme Agent Moral. *Revue française de sociologie*, 4(53): 657–688.
- Mekdjian, S. 2016. Les Récits Migratoires Sont-Ils Encore Possibles Dans le Domaine Des Refugee Studies? Analyse Critique et Expérimentation de Cartographies Créatives. *ACME: An International Journal for Critical Geographies*, 15(1): 150–186.
- Mekdjian, S., Amilhat-Szary, A.-L., Moreau, M., Nasruddin, G., Deme, M., Houbey, L. & Guillemin, C. 2014. Figurer les Entre-Deux Migratoires. Pratiques Cartographiques Expérimentales entre Chercheurs, Artistes et Voyageurs. *Carnets de géographes*, (7). [carnetsdegeographes.org/carnets\\_terrain/terrain\\_07\\_01\\_Mekdjian.php](http://carnetsdegeographes.org/carnets_terrain/terrain_07_01_Mekdjian.php), 13 January 2018.
- Pestre, E. 2012. Le Réfugié : un Sujet en Péril Psychique et Politique (Note de Recherche). *Revue Asylon(s)*, (9). [reseau-terra.eu/article1246.html](http://reseau-terra.eu/article1246.html), 14 January 2018.
- Signorini, V. 2015. Producing Memory: Narratives of Suffering in the Asylum Experience. *Subjectivity*, 8(4): 382–408.

### Illustrations

Maps by H.S., Nasruddin Farouk Gladeema, Alishum Ahmedin, Marie Moreau, Kanké Tounkara, Issa Ibrahm Ahmid, Ahmedin A., S.A.

Photographs by Mabeye Deme

Turkey

TURKIA POLICE

GRACE

Austria - Hungary - Romania - Bulgaria

Italia

France



ship

walk

car

140 person

??





shot on car  
person dead

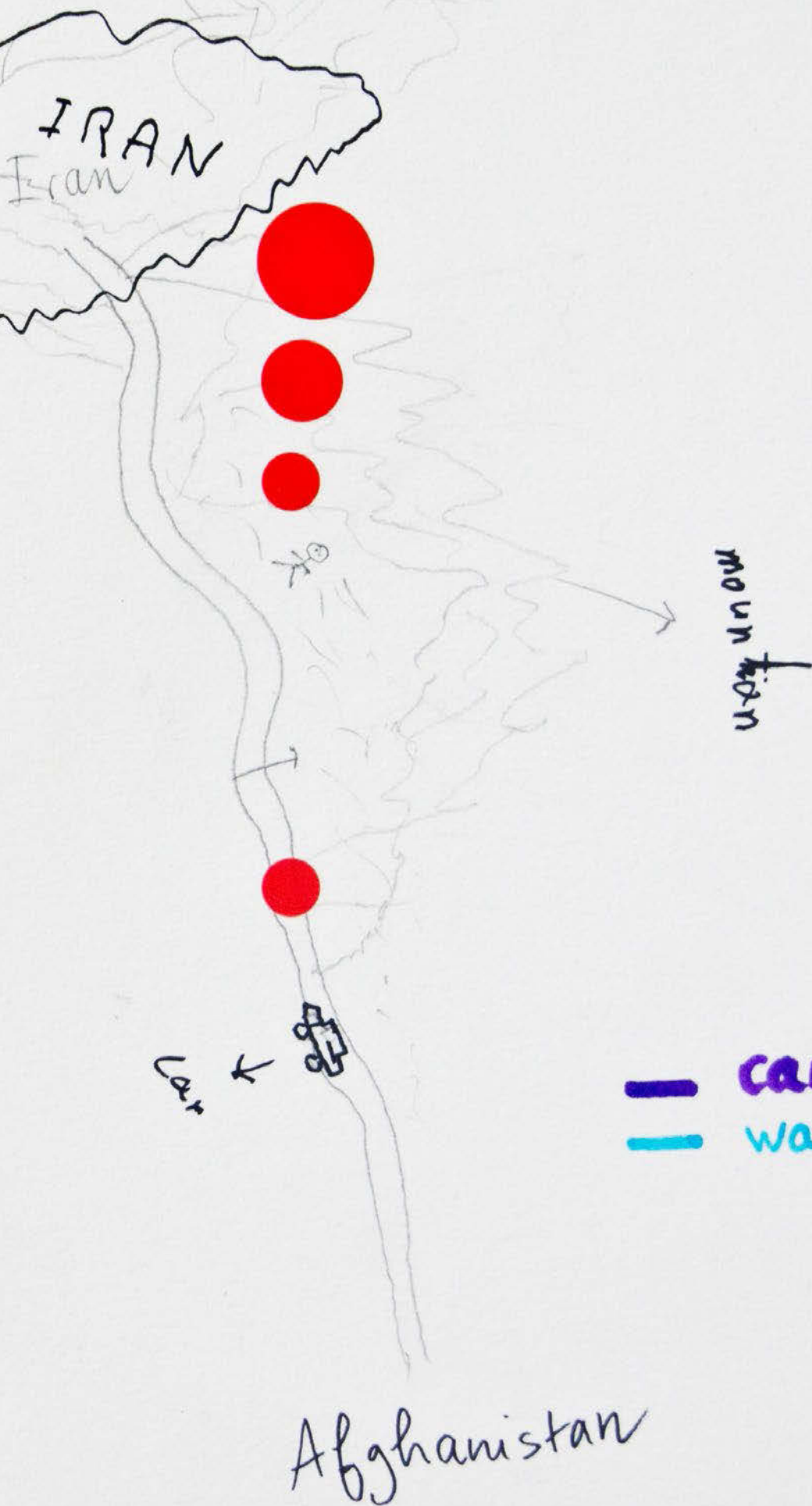

## Les Légendes du voyage

●●●●● Danger

+ Soins Médicaux /  
Medical care

▲▲▲ Stress  
Faim - Fatigue /  
Hunger - Tiredness

? Où? Comment? / Where?  
Pourquoi? / How?  
Why?

▲▲▼●● Mort /  
Death

●●●● Tranquille /  
Easy

●●● Rencontre, amitié, amour /  
Friendship, love

●●● Police

●●●● Chance

●●● Avoir chaud / to be hot

●●●● Avoir froid / to be cold

⚖ Injustice

●●● Peur / Fear  
Ateliers de cartographie  
Grenoble, 2013

# Textile Maps<sup>1</sup>

## Using Sensitive Mapping for Crossovers Between Academic and Vernacular Worlds in the Sidi Yusuf Working-Class Neighbourhood in Marrakech

Elise Olmedo

Projet Carte Sensible - croquis de synthèse

Jemaâ-El-Fra - Repère central de la mobilité.

Nœud - Chemins qui en partent et en arrivent.

Oppression de genre - partout → doubleure.

Oppression de classe - travail → tissu riche. Choc/Rupture entre les deux quartiers.

Espace domestique + Extérieur immédiat.

E.d - oppression (guillage) promiscuité - "les murs ont des oreilles" (transparent). Vidences conjugales (cicatrices, coutures). Esp. multifonctionnel. Guillage + transparence → dimension encore + plurielle de l'oppression.

E.i - Approvisionnement Familier → communités fixes, pairs, paires, paires. Dictature de la vie quot. → Scratch → chemin sacré, divers endroits - labilité. Mobilité et fluctuation des vendeurs ambulants ≠ du souk-stabilité. On trouve de tout → + couleurs et matières.

Pôle Travail

Pôle Domestique.

VUE D'ENSEMBLE 1 x 1 m.

Tissu riche des mariages. Cordon → signale barrière sociale.

• Travail aléatoire. Pau "bouche à oreille".

Loisir dans les INSERSTICES du Travail.

→ Parc (Ardal, Waha) → Hammam → double au accès genre → entrée Petite ouverture car y va seule. → couture.

PÔLE DOMESTIQUE

PÔLE TRAVAIL

In this project, we consider textile maps as part of the broader topic of sensitive mapping. By retracing geographical research carried out in Morocco between 2010 and 2016, this article introduces an evolving map-making project with women from the Sidi Youssef Ben Ali neighbourhood in Marrakech – more commonly known as Sidi Yusuf, a city in Southeast Morocco. This textile mapping is a post-visual art which is used to render places as they are experienced and lived in by the women of a working-class neighbourhood. More broadly, it proposes geographical fieldwork tools for understanding the complexity of spaces: what one feels in a certain place from a sensory and emotional perspective, and how this is connected to the surrounding space. This qualitative mapping seeks to establish a sensitive link to geographical knowledge.

### **From Fieldwork to the Writing of Research: A Relational Approach to Cartography** **Reintroducing Sensitivity to Cartography**

Relational approaches focus on the co-production in research processes. They concentrate on the relation between researchers and participants, which in turn creates the research object itself. In these approaches, mapping processes have been reconceptualised: Cartography does not merely represent, but rather generates something that results from the involved persons' relation. By emphasizing the importance of haptic perception in mapmaking, this mapping is about reintroducing sensitivity to the production of geographical knowledge. By taking an interest in how we experience space and how this creates geographical visibility, sensitive mapmaking emphasizes the social and gendered dimension of urban practices, from domestic situations to public spaces of Marrakech. These textile maps display the lived spaces and routes of working-class women who live in this neighborhood. The geographic knowledge is depicted through cartographic gestures, combined in the production of the maps themselves (creation), and in the map reading (reception). The mapmakers sew and embroider, and the readers touch and manoeuvre the map to read it. While requiring a tactile appreciation alongside a visual one, these maps question the hierarchy of the senses, and examine the visual primacy in geographical thinking. Thus, textile mapping demands the involvement of the body in producing, perceiving, and understanding geographical knowledge.

The cartography on which this article focuses has been field-tested, both in its research and its diffusion. The objective of sensitive mapping is to include the sensitive dimension of spaces through the elaboration of language in relation to the location of the research, be it in the field or the place in which it is displayed (laboratories, academic events, symposia). The cartographic research presented here is therefore produced in situ, in the presence of people, with different degrees of participation, depending on the contingency of this sensitive situation. Thus, the cartography is used as a means of creating links between researchers and participants in places where these are constructed.

### **Marrakech: Retroactive Fieldwork**

The sensitive maps that are displayed here have been created on the basis of two field investigations. This allowed for both, an empirical observation of the practices in women's lived environments and a glimpse at their daily lives. Nonetheless, the two surveys had different functions within the research. The first field investigation (2010) provided qualitative research by combining qualitative interviews and participant observations of fifteen people over the course of two and a half months. These were primarily women from working-class neighbourhoods, predominantly with rural origins, who were interviewed in order to define their relationship to urban spaces. The second field investigation (2014) involved working together with the same people for the duration of one month. During this time the results of the work carried out in 2010 were presented, submitted and validated. The textile map from 2010 (see textile map showing living spaces of women from Sidi Yusuf) played a prominent role in the presentation of the results about working spaces and lived spaces. It allowed us to create what I refer to as a "retroactive fieldwork", using a tactile language. Allowing these women to see and touch the fabric while recounting their own experiences of the city created a sensitive experience that activated memories of a place where they had lived together in 2010. From this cartographic narrative emerged both, vernacular and academic knowledge. These initial exchanges about the subject of the textile map even gave rise to the idea of creating a second map (see textile map of Sidi Yusuf) with Naïma, one of the participants. Five other local women were involved, as well as Hanane Hafid, PhD student of geography at the University of Marrakech, who served as a translator for the collective project. Far from being a prerequisite for academic research, this map places a retroactive loop in the construction of knowledge, in which the sensitivity is placed at the forefront of the mode of operation of the map.

These maps highlight the complexity of the relationship between the women of Sidi Yusuf and places they live and work in. They were created by using classic academic techniques, such as qualitative interviewing, participant observations and field drawings. The depicted areas reflect a diversity of spaces, from the home to the city of Marrakech, from domestic to public spaces. This physical mapmaking allows for the materialization of urban practices while providing information on social relations with regards to class, gender, and race.

The textile map from 2010 (see textile map showing living spaces of women from Sidi Yusuf) is composed of two parts and two kinds of material. On the right side, the domestic part has been created with an inexpensive fabric normally used to stitch the inner lining of the traditional Moroccan clothing (Djellabah). This part shows the two main areas in these women's lives. The home is depicted here by a patchwork square made of many different fabrics that represent the multifunctional character of the domestic space. It consists of many forms that reflect the places that change over the course of the day (dining room, reception room, sleeping area) and the places frequented in the immediate vicinity of the home (hammam, food shop, bread oven, butcher, souk). The other part of the map on the left side represents informal places of work that essentially involve household chores, with the Medina and the



Guéliz neighbourhood being prominent. The two parts are joined by a central knot – the Jemâa-El Fna square. This is a reference point for these often illiterate women, whose mobility is contingent on their work, and also depends on social links governed by class and gender. It is mostly these links that dictate where women from poor neighborhoods can walk through the city and work. This map is a piece of research that was completed upon my return from the field. It displays the complexity of these womens' experiences in the city of Marrakech, taking Naïma's case as an example.

The second textile map was created collectively after returning to the field in 2014. The objective was to present the results to the women who were involved (see textile map of Sidi Yusuf). This collaborative work was made possible by returning to Marrakech in order to show the works created during the original project. The first map was presented to the women by means of cartographic narration, and they were invited to touch the map. In recounting their lives to the women of the neighbourhood, we were able to discuss the ways in which the women's situation had changed since 2010. We were also able to talk about the durability of fabric as a cartographic language. These exchanges, translated by Hanane Hafid, led to the fabrication of the second map with Naïma's help and that of other women from the neighbourhood. Since the women approved of the first map in our discussions, the second map presents the same spatial characteristics. However, these characteristics are expressed differently. We can see lived spaces where the home is represented by yellow pieces of fabric woven together and where white routes leading to Jemaâ-El Fna square are shown in a green fabric. Another piece of white fabric represents the workplace.

The map not only expresses the potentials of mapping as a geographical result of demonstrating the geographical representation of individuals who are dealing with a new agency of geographical knowledge. From a practical perspective, it is also about the constitution of an iterative process of knowledge production, whose specifics will be presented now.

## Mapping: Cartography as a Research Process

The research responds to an observation made about underestimating the importance of field work. By understanding space, field practice allows a processual construction of knowledge adapted to live situations in constant evolution (Olmedo, 2015). Sensitive mapping investigates the role of sensitivity in the academic production of spaces. By inviting us to reconsider the sensitive dimension of spaces, it demonstrates that experience should not only be considered in human and social sciences. Instead experience itself should also be the subject of research, as it may be able to shift perspectives and thus introduce an operational dimension. We should therefore consider this research area as an actively evolving space. In this sense, there is no more insurmountable schism between the field and the laboratory or the researcher and the participants of the research.

It is here that the notion of "mapping" occurs (Cosgrove, 1999), a notion that describes the cartographic process. In our case, the idea of a cartographic process allows for a sensitive approach to map-making. Rather than the conception of an individual map, it is the entirety of the processes which is most important for the realization of the cartographic project and its subsequent perception. We become less interested in the object itself, and more interested in its use.

## Making the Maps

The first instance is about emphasizing the process of creating textile cartography. These maps were the product of several days of work, reels of thread and fabric bought in the Souk in Sidi Yusuf, hours of discussions, creative hands, skills – particularly in the fields of embroidery and traditional Moroccan sewing – and lastly the help of a local tailor for the final assembly of the map in 2014. They are therefore composed of "cartographic gestures": cutting fabric, assembling, sewing, embroidering, that allow for a physical expression of knowledge (Olmedo, 2015). In this sense, we place special emphasis on the way in which bodily knowledge of spaces manifests itself in the malleability of the map, both in the physical act of creation and in a formalization of properly communicating this geographic knowledge with others.

Following each participant's involvement, these maps have been created in collaboration with the people whose aim it was to visualize and shape the different perspectives on the map. The map resonates with the sensitive areas and the people who frequent them. This perspective is mediated by the place and time in which the map was made, as well as by the modes of language that were used (oral and textile). In this particular case, the map was created through discussions and textile work.

This work also debates epistemological questions with regards to geography. Based on a critique of representational geography, we are interested in the appearance of "post-representational", "non-representational" (Thrift, 2008), or "more-than-representational" thinking (Lorimer, 2010). We believe in the importance of these concepts for regenerating the concept of geography. At the same time, we distance ourselves from them because of their apolitical approach. From a more anthropological perspective, we

consider sensitive map-making as a relational medium that denotes a departure from map-as-object. The idea of an object in process (see illustrations), otherwise known as mapping, replaces the framework of map-as-image.

### **Sewing Together: Collaboration and Cartography**

This project attempted to research the participants' sensitive relationship to their spaces, the sensitive contact between the researcher and the participants as well as the role of the translator, using local materials and creative methods. What place do these specific languages have in the field of cartography? How do we allow for situation-appropriate map-making in order to avoid reproducing power relationships linked to cartographic knowledge (Burini, 2008)? These maps are collaborative, encouraging the construction of an in-situ knowledge for which the researcher collaborates with the participants of the research. In this research, mapmaking is considered the medium through which the researcher and the participants come together.

On the other hand, this form of mapping raises the question of cartographic language: It encourages the creation of field-adapted cartographic languages. These are born out of interaction with locals in the field, based on which we aim to produce cartographic documents: co-authorship, processual geographical reasoning, creative expression of an empirical phenomenon witnessed "on the spot". These maps are indeed phases of work aimed at experimenting with the ways in which we can depict a lived environment. Their language is therefore dependent on the research location while seeking to correspond to the lived situation of the research participants. Each map generated several cartographic experimentations, allowing for a final product that is as close a representation as possible of the lived situation. The final maps synthesize individual experiences. The different versions correspond to one research process – the exploration of a contextual and open language – that should incrementally improve.

### **Towards New Cartographic Ethics**

At the end of this project, rather than being a representation, the map is a production of space. While retaining the requisite characteristics for mapping – those of depicting space – this project proposes new ways of creating and appreciating maps. By no longer considering the map as an object but rather as the result of its co-creation, we approach the idea of cartography as something that is practiced in relation to a given sensitive situation and is therefore contingent on its creators. In this regard it is more of an "expression of space" inspired by artistic contribution to cartography (Wood, 2006).

This project also raises the question of the possibility for the participants of the research to access the results of the conducted research. These non-textual maps encourage a cartography that takes into account the reality of social situations – in our case the illiteracy of the majority of our participants. The map created in 2010 was initially considered to be a means of communicating an overview of the research results to the participants. What is more, returning to the field in 2014 allowed me to devise research over

the course of several years (four years had passed between my first visit to Sidi Yusuf in 2010). By returning to Sidi Yusuf, I was able to present the results to the research participants without replicating power relationships in the communication of knowledge. These comings and goings make it possible to reflect on the access to knowledge, as these maps were as pertinent to geographers as they were to illiterate women. Textile maps create channels between the world of science and the world of participants of research.

By reintroducing sensitivity to the creation of geographical knowledge, this kind of mapping allows for a complex understanding of geography for non-academic audiences. By reintroducing the haptic sense, this cartography makes knowledge something that can be grasped with your senses. This is the case for both, the makers of the maps seeking to understand and cope with their daily lives, as well as the readers aiming for a tactile understanding of these experiences.

*Translation by Samuel Fraine*

### **Endnotes**

1. This chapter is an abridged English translation of an article published by the author in the review *Cartes & Géomatique* sponsored by the French Committee of Cartography (CFC) in 2016, 229: 135-145. [lefc.fr/new/articles/229-article-16.pdf](http://lefc.fr/new/articles/229-article-16.pdf), June 27 2018. This article and all its illustrations are licensed under a Creative Commons Attribution-NonCommercial-NoDerivatives 4.0 License (CC BY-NC-ND 4.0).

### **References**

- Burini, F. 2008. La cartographie participative et la pratique du terrain dans la coopération environnementale: la restitution des savoirs traditionnels des villages de l'Afrique subsaharienne. *À travers l'espace de la méthode: les dimensions du terrain en géographie*, 18-20 June 2008, Arras.
- Cosgrove, D. 1999. *Mappings*. London: Reaktion Book.
- Lorimer, H. 2005. Cultural geography : the busyness of being "more-than-representational". *Progress in Human Geography*, 29(1): 83-94.
- Olmedo, E. 2015. *Cartographie sensible. Tracer une géographie du vécu par la recherche-création*. PhD Thesis. Paris: Paris I Panthéon Sorbonne.
- Olmedo, E. 2010. Cartographie sensible, émotions et imaginaire. *Visions cartographiques*. [visionscarto.net/cartographie-sensible](http://visionscarto.net/cartographie-sensible), 15 June 2018.
- Thrift, N. J. 2008. *Non-representational theory: space, politics, affect, Milton Park*. Abingdon, Oxon; New York, NY: Routledge.
- Wood, D. 2006. Map Art. *Cartographic Perspectives*, 53: 5-15.

### **Illustrations**

Map on following spread left by Elise Olmedo, 2010.

Map on following spread right by Naima S., Hanane Hafid, Elise Olmedo and women of Sidi Yusuf, 2014.



Textile map showing living spaces of women from Sidi Yusef.



Textile map of Sidi Yusuf.





*Imaging Homelessness in a City of Care* was a participatory mapping project undertaken with 30 single homeless people in Newcastle-upon-Tyne (UK) in 2014. The project's objectives were three-fold: to pilot an innovative mapping-based methodology; to offer single homeless individuals an opportunity to comment on local service provision and delivery; and to inform and challenge public perceptions of homelessness. In what follows, we outline the context for the project and the reasons for adopting a mapping approach. We then discuss the research process and the various insights generated. Finally, we reflect on the effectiveness of the methodology used.

### Research Context

The term "single homelessness" refers to adults without dependent children who are not entitled to housing provision under homelessness legislation in England. In the absence of formal monitoring processes, it is a category of homelessness which remains largely unquantified. Figures indicate, however, that rough sleeping levels have increased by 134% since 2010 (DCLG, 2017). The increased visibility of homelessness on our streets is provoking mixed reactions. Gifts and donations to many homelessness charities have increased, while greater engagement with street homelessness by faith-based groups is also evident (Cloke et al., 2012). At the same time, media scrutiny of the character and morality of homeless people has also increased (Fitzpatrick & Pawson, 2014), and punitive responses to street homelessness also remain prevalent (Harding & Irving, 2014). In this highly polarised context, it is important to both inform and challenge public perceptions of homelessness.

### Research Process

The research proceeded by means of six workshops with 30 rough sleepers and users of supported accommodation. Participants were encouraged to annotate two-dimensional maps of the Newcastle city centre with reflections on the spaces, places and experiences significant to their life courses. The maps played a useful prompting role in the surfacing of participants' experiences, attitudes and values. Many participants were engaged with following a night of rough sleeping, meaning the articulation of life events through conventional talk-based methods would likely have proven challenging. Furthermore, the intuitive nature of map-making was intended to empower participants to take control of the research process. The generated mappings were shared with the artist Lovely JoJo, who prepared a "composite" map. The aim here was to present the participants' perspectives in a manner that was deliberately lo-fi and therefore in keeping with their selective and subjective nature.

### Findings

The composite map displays a complex and often contradictory mix of practices. First, it highlights the large diversity of pathways along which individuals progress into homelessness; "evidence" that, while some people may be more predisposed to falling into homelessness, ultimately, anyone can fall victim. Second, the map highlights the daily challenges associated with street homelessness, as well as the multiplicity of survival strategies employed in response. While many of the strategies in evidence resonate with existing stereotypes, they can also be viewed as instances of "individuals cleverly deploying their creativity, competence and cultural knowledge to survive" (Duneier, 1999: 312). Third, it presents a series of counter-readings of the use of city spaces and forms. Doorways, for example, are reproduced as social and sleeping spaces, while pipes and ducts are shown to provide a modicum of warmth and comfort. Fourth, the map reveals a range of behaviours and activities characteristic of "normal" functioning lifestyles, thus presenting the participants as fully emotional subjects with needs, desires and a genuine sense of themselves (May & Cloke, 2014). Finally, it depicts the variety of the city's homelessness services. While there was evidence of punitive responses to homelessness, most participants spoke highly of the received support.

### Participatory Mapping as a Social Research Method

The map proved highly effective in capturing the imaginations of audiences. The project's launch was attended by over 60 policy makers, practitioners and academics. The project blog has received over 5,000 hits from over 40 countries, and the map has received widespread media coverage, with an audience reach of over 2.5 million. The positive reaction appears to be based on the ability of the map to engage audiences instinctively and emotionally. Those offering comments stressed how the map served to emphasise the many different meanings assigned to the city, whilst also humanising discussions of homelessness. Comments included: "I found the maps of the participants and Lovely JoJo deeply affecting. I find myself returning to them and reconsidering the places I thought I knew."

However, the composite map is not without limitations. It does not provide an objective picture of homelessness in Newcastle-upon-Tyne. On the contrary, it is a social construction with its own performative character. Participants selected information to be mapped based on their "in-the-moment" subjective realities. Furthermore, the map is only partially able to depict the complexity of homelessness. Objects and events which lack geographical specificity (e.g. mobilities) are frequently obscured, despite the array of arrows and symbols. Therefore, mapping processes such as this one are probably most useful when used in combination with other methods of data collection.

## Conclusion

For us, the experience of participatory mapping has confirmed the suggestion that many traditional methods of social science fail to engage with the many aspects of everyday life, thus lying outside the narrow discourse. There are, on occasions, thoughts, feelings and experiences that are simply "unspeakable". The value of maps such as this one, therefore, lies in their ability to engage an audience instinctively and emotionally, rather than through "rational" argument. Creative approaches to writing, mapping and image-making appear to be just some of the ways in which researchers can seek to access and communicate embodied and pre-reflexive knowledge.

## References

- Cloke, P., Johnsen, S. & May, J. 2012. Ethical citizenship? Faith-based Volunteers and the Ethics of Providing Services for Homeless People. In Beaumont, J. & Cloke, P., eds. *Faith-Based Organisations and Exclusion in European Cities*. Bristol: Policy Press: 127–152. [researchportal.hw.ac.uk/en/publications/ethical-citizenship-faith-based-volunteers-and-the-ethics-of-prov](http://researchportal.hw.ac.uk/en/publications/ethical-citizenship-faith-based-volunteers-and-the-ethics-of-prov), 14 January 2018.
- Department for Communities and Local Government 2017. *Rough Sleeping Statistics. Autumn 2016, England*. London: Department for Communities and Local Government. [gov.uk/government/statistics/rough-sleeping-in-england-autumn-2016](http://gov.uk/government/statistics/rough-sleeping-in-england-autumn-2016), 14 January 2018.
- DeVerteuil, G. 2003. Homeless Mobility, Institutional Settings, and the New Poverty Management. *Environment and Planning A: Economy and Space*, 35(2): 361–379.
- Duneier, M. 1999. *Sidewalk*. First edition. New York: Farrar, Straus and Giroux.
- Fitzpatrick, S. & Pawson, H. 2014. Ending Security of Tenure for Social Renters: Transitioning to 'Ambulance Service' Social Housing? *Housing Studies*, 29(5): 597–615.
- Harding, J. & Irving, A. 2014. Anti-Social Behaviour among Homeless People: Assumptions or Reality? In Pickard, S., ed. *Anti-Social Behaviour in Britain*. London: Palgrave Macmillan: 155–165. [link.springer.com/chapter/10.1057/9781137399311\\_13](http://link.springer.com/chapter/10.1057/9781137399311_13), 14 January 2018.
- Jocoy, C.L. & Del Casino, V. 2010. Homelessness, Travel Behavior, and the Politics of Transportation Mobilities in Long Beach, California. *Environment and Planning A*, 42(8): 1943–1963.
- May, J. & Cloke, P. 2014. Modes of Attentiveness: Reading for Difference in Geographies of Homelessness. *Antipode*, 46(4): 894–920.

## Illustrations

Map by Lovely Jojo's (lovelyjojoes.com)



ooty →

↑  
TB Secondary school

↑  
'IN WHITLEY BAY AGED 16-21'  
- SAM



'DID LOTS OF JOB COURSES IN NORTH SHIELDS, JOINERY, DECORATING, NEVER HAD A JOB'  
- A.J.

'STILL USING DRINK + DRUGS BUT VERY SAFE'

↑  
in flat - moving away from dad  
memorys self worth higher

↑  
'I WENT TO TYNE MET COLLEGE I DID LEVEL 1+2 LEARNING SKILLS'  
- LS



planned by man  
School died  
2 friends time  
confusing time  
looking BK

SALVATION ARMY  
cedar House

**BERT, 27**

WENT TO WARRINGTON SCHOOL FOR 9 DAYS BUT DIDNT LIKE IT, SO DIDNT FINISH. MAMA WORKED FT SO COULD SWEAK HOME DURING THE DAY HAD TO HIDE IN THE CURTAINS WHEN MAMA CAME HOME. WAS 20 ST!

BETTER SINCE WE USED TO CHUCK PINS OUT OF THE WINDOW. THATS THE ONLY SIDE OF THESE PLACES

MOVED HERE WHEN I WAS 16. ENDED UP IN THE GENERAL.

1ST FATHERS. FRANKS HOUSE. OK AT THE TIME BUT ALL ON DRUGS AND ALCOHOL. WAS A NORMAL WAY OF LIFE IN THERE. HUNG OUT WITH YOUNG PEOPLE + STARTED TAKING DRUGS. OVERDOSED ON HEROIN.

REN ENGER - FOOD, SHOWER, CLEAN CLOTHES.

SA-3 DAYS, KICKED OUT I DONT KNOW WHAT HAPPENED DURING THESE 3 DAYS - LITTLE MEMORY!

WAS CLEAN, WORKING, HAVING FUN HERE. PROBLEMS STARTED IN THE HOSTELS.

MOVED TO TOMS CLAY VILLAGE. UNITS FOR MEMORIES SAKE. WOULD HAVE SAVED THEM.

IN NEWCASTLE, THERE IS NO NEED FOR ANYONE TO BE HUNGRY AND DIRTY. YOU CAN GET MONEY TO FEED A FEW TIMES A DAY AND ALWAYS GET A SEVERAL REALLY GOOD COMPAS. NEW DRUG CAPITAL OF THE NE.

COME DOWN FROM 90 - 75 PMS OF MATH. WHEN DOWN TO 30, HAS FUNDING TO GO TO PETHAR. WANTS OWN FLAT. WHEN CLEAN NEVER GOING TO TOUCH ANYTHING ADDICTIVE AGAIN.

ELIOT HELPED GET A FLAT HERE. FANTASTIC AS LONG AS COMPANY. BUT LIED ABOUT DRUGS HABIT, WAS STILL USING WITHOUT TELLING HEROM. ACHIEVEMENT. REWARD THROUGH READING WITH GIRLS.

MOVED NEXT TO BE'S MAM. DONT GET ON.

MOVED TO LUTHERINGTON. MOTHER. UP IN SCOTTY SHIELDS. ST.

# NEWCASTLE UPON TYNE



BBC PINK PALACE

Castle Leazes

meeting spot as a young teen - Paul

BERT MOVED HERE WHEN 18

"LEAZES PARK. FIRST PRIZE WITH LASS" - SCOTT

"SLEEP UNDER TREES"

Leazes Park

WARRINGTON TURN

'Slept here'

'drink in town every where'

'USED TO PLAY FOR TOON AT AGE 12 TO 15 MET ALL PLAYERS SADLY LEFT YEAR BEFORE SHEARER'S ARRIVAL - J.T

'Love to go cant afford to go!'

'GOT A HOUSE'

'L.B. 1st time slept RUFF MNS

Arthur's Hill

Gettin High

'Kicked out Yr 4 Trying to Stab Teacher' - Paul

MAM LIVES HERE!

'Went to School from YR 8 to Yr 11. Should have Attended more'

'GOT KICKED OUT FOR HAVING 350ME' - SHIRGEN

Westgate Hill Primary School

'Education is the ability to almost anything without losing your temper or your self - confidence' - Robert Frost

'WENT TO ST JAMES WITH BRO TO SEE RESIDENTIAL WORK. WAS A MESSING UP DAY' - BERT

St James' Park

'LIVED HERE WHEN FIRST HOMELESS. MADE FRIENDS BUT REVOLVED AROUND DRUGS + ALCOHOL' - A.J.

'FOOD'S ALRIGHT... CHAOTIC' - ATE 2 DINNERS + PUDDINGS AND MICHAEL'S DINNER' - GEORGIA

'BEGGED MONEY AND FOOT TO PEOPLE I WANTED TO MEET' - SCOTT

'SAVED MY LIFE'

CHANGING LIVES

'Drop ins volunteer part e.g. to'

CHANGING LIVES

'FRIEND DIED' - FOOD WAS ALRIGHT

FOOD'S KITCHEN

'FOOD'S ALRIGHT... CHAOTIC' - ATE 2 DINNERS + PUDDINGS AND MICHAEL'S DINNER' - GEORGIA

'BEGGED MONEY AND FOOT TO PEOPLE I WANTED TO MEET' - SCOTT

'1st HOUSE SUPPORTED' - HARRIS IS A GOOD KEY WORKER

'MOVED TO ELLIOTT, LIKED GARDEN BETTER THAN PITT STREET' - A.J.

'OK LIVED HERE 4 WEEKS' - STEVEN

'Lived HERE'

'PLACE FOR HELP'

'HELPING GEORGIA GET REHAB AND COUNSELLING'

'IT'S QUIET. USED TO CHAOS, BUT SOMETIMES I MISS IT'

'Lifeline Harm Reduction Service'

'BETTER STACE CHUCKED OUT JR. USED TO CHUCK PINS OUT OF THE WINDOW. USED DIRTY NEEDLES THAT'S THE BAD SIDE OF THESE PLACES'

'WIPE YOUR FEET ON WAY OUT' - SHIRGEN

'1st HOMELESS. FRANCIS HOUSE. OK AT THE TIME BUT ALL ON DRUGS AND ALCOHOL. WAS A NORMAL WAY OF LIFE IN THERE. HUNG OUT WITH YOUNG PEOPLE + STARTED TAKING DRUGS. OVERDOSED ON HEROIN ENDED UP IN THE GENERAL.'

'Friends live here'

'A BIG HELI SENT 3 MONTHS ON THE STREET' - A.J.

'OWN tenancy' - Lived here for 12 years

'DANCE CITY' - 'DANCE IN THE FUTURE'

'Full of checkies Central station'

Elswick Park

'Born + Bread HERE!' - Paul

CHANGING LIVES Hawthorn Terrace

Family

'PROBATION TWICE A WEEK'

'CASINO' - Went to college painting + decorating

'I'D LIKE TO GO ICE SKATING' - LS

'NEW POLICE STATION'

'WANT TO GO BACK' - GORDON

'my college' - David

'studied drama' - David

'I'D LIKE TO SEE GLEE LIVE AT METRO RADIO ARENA' - LS

'WHERE GEORGIA GOT HER HEALTH + SOCIAL CARE DIPLOMA AND ENOUGH UCAS POINTS TO GO TO SUNDERLAND UNI. LEAVING CARE TEAM USED ME AS AN EXAMPLE OF SOMEONE WHO STARTED WITH NOTHING AND WENT TO UNI.'

'EVENT cover ohr contract' - Paul

'Daily walk across Redheugh'

'POST MAN' - M.D.

'DRINKING FIELD (Marby Central)'

'first hostel' - CHARLIE LIVE HERE TOO

'A.J. LIVES HERE. HE GETS ON WELL WITH THE LABS. RENT IS CHEAPER THAN OTHER PLACES. HE LIKES BEING ABLE TO BUY HIS OWN FOOD AND STAY CLEAN HERE.'

'SHINY NEW CARS' - GORDON

'my college' - David

'studied drama' - David

'I'D LIKE TO GO ICE SKATING' - LS

'NEW POLICE STATION'

'MOVED TO SCOTSWOOD' - 'GETTING IN BOTHER IN WALLSEM' - Michael

'GREW UP IN SCOTSWOOD' - STEVEN

'WANT TO GO BACK' - GORDON

'I'D LIKE TO SEE GLEE LIVE AT METRO RADIO ARENA' - LS

'WHERE GEORGIA GOT HER HEALTH + SOCIAL CARE DIPLOMA AND ENOUGH UCAS POINTS TO GO TO SUNDERLAND UNI. LEAVING CARE TEAM USED ME AS AN EXAMPLE OF SOMEONE WHO STARTED WITH NOTHING AND WENT TO UNI.'

'EVENT cover ohr contract' - Paul

'Daily walk across Redheugh'

'POST MAN' - M.D.

'IN SW FOR 10 YEARS GOT A YTS (WHITLEY BAY)'

'GREW UP IN SCOTSWOOD' - STEVEN

'WANT TO GO BACK' - GORDON

'I'D LIKE TO SEE GLEE LIVE AT METRO RADIO ARENA' - LS

'WHERE GEORGIA GOT HER HEALTH + SOCIAL CARE DIPLOMA AND ENOUGH UCAS POINTS TO GO TO SUNDERLAND UNI. LEAVING CARE TEAM USED ME AS AN EXAMPLE OF SOMEONE WHO STARTED WITH NOTHING AND WENT TO UNI.'

'EVENT cover ohr contract' - Paul

'Daily walk across Redheugh'

'POST MAN' - M.D.

THE TYNE. B4 ELLIOTT GAVE ME A BED I WAS HOMELESS I WANTED TO DIE - SAM



TONY SLEPT HERE FOR A NUMBER OF WEEKS

'I WAS MARK' 2005

\*A.J.'S MATE'S LIVE HERE

'SOFA SURFED AT FRIENDS' HERE FOR 6 WEEKS - A.J.

My hostel, I live now - RC

'SLEPT BEHIND' PRIMARY

\*GREGGS 'I WAS WARM BUT POLICE MOVED US ON' GREGGS IS ACTUALLY DOWN HERE. OOPS.

'I WOULD LIKE A FLAT HERE SO I CAN LIVE BY MY OWN RULES' - A.J.

'WHERE MY FRIENDS LIVE GO THERE TO SEE SIOBHAN' - LS 'HOME FUND RAISING AROUND SHIELDSFIELD' RYAN

The City Stadium that never was

'drinking + drugs with friends' cold, drunken nights 'KICKED OUT RENT A'

'SLEPT BEHIND' PRIMARY

\*TONY SLEPT HERE! 'FIRST SLEPT ROUGH UNDER WIRRAK AT 24' 'CAME BACK AT 24' 'EXTRACTOR KEYS' 'WANT A WARM' - GEORGIA

'SLEEP, MATE' 'Parents live here' 'CITY CAMPUS EAST' 'TONY SLEPT HERE IN A TENT!' 'Good MB Lives here' - TH

'This building recycled 95% of the material from the old Warner Cinema'

'BYKER FARM' 'WAS MY HOME AT I DID NOT KNOW WHERE TO GO FOR HELP' - SB

'LIVED IN HOSTEL 2002. LOTS OF GOT TAXED AT IN CHILLI ROAD'

FOR DRUGS DIDN'T LIST ABOUT WHY MONEY

'LIVED HERE FOR 4 MONTHS' 'T-11' 'VERY WARM' 'ON STAIRS' 'S.T.' 'LAING' 'I LIKE AUDIO BOOKS OF COURSE' '20 YRS' 'Rehabilitation' 'Ni. Rehab' 'Healing' 'Plummer' 'Court' 'I TEETING TWICE A WEEK. USEFUL BUT WOULD LIKE MORE SUPPORT TO STAY CLEAN!' - JOE

'North East Council on Addictions'

'LIVED IN SA 5 TIMES' 'SPT!' 'GOT INTO FIGHTS' 'GRIEF OFF OTHER RESIDENTS' RYAN

'This is a area I wouldn't go into' 'AA MEETINGS' 'St. Ann's Church'

'Bad Place go for the + getting' 'I LIKE SWIMMING BYKER POOL WITH S AND HER SUPPORT'

'VERY HELPFUL' 'once in a while' 'FINALLY GOT HELP' 'HAD TO GO A LOT' - SCOTT

'CRISIS' 'dedicated to ending homelessness' 'STAYING TIME HERE DURING MY DIVORCE' 'I FOUND THE STAFF GOOD TO WORK WITH' - SB

'TERRIBLE' 'PEOPLE CLIMBING IN AND OUT OF WINDOWS' 'FOR CANNY WHILE STEVE' 'Smells like trench foot' 'SHIREEN' 'Paddie' 'march' 'sold clothes' 'and rag' 'G.L.'

'LIVED IN SALLY ARMY WITH BROKEN LEG. HAD A FIGHT ON CRUTCHES. VERY CLEAN BUT VERY LAID BACK' - J.T.

'USED TO TALK TO WEATHER MAN' 'PAUL MOONEY' - J.T.

'ELLIOTT' 'A FLAT HE' 'AS LOVE O' 'BUT LIED A HABIT WAS 14 MONTHS WITHOUT T' 'ACHIEVE' 'THROUGH A'

'old job for circuit 1 was shift' - David

'SIGHT SEEING' 'SLEPT NOT NICE' 'Belonging' 'SUICIDE' 'last good night out - open evening for great northern' - David

'I LIKE TO GO FOR WALKS ALONG THE QUAYSIDE' 'FOR WALKS ALONG THE QUAYSIDE. READ THE HISTORY OF THE QUAYSIDE!' - A.J.

'I LIKE TO GO FOR WALKS ALONG THE QUAYSIDE' 'FOR WALKS ALONG THE QUAYSIDE. READ THE HISTORY OF THE QUAYSIDE!' - A.J.

'I often dream about the Tyne bridge, I don't know why'

'MOVED TO WASHINGTON MISTAKE. MOVED NEXT TO EX'S MAM. DIDN'T GET'

'CHANGING LIVES' 'Julie's' 'gym' 'Hall' 'meeting' 'Coourage' 'People' 'can' 'and' 'do'

'SAGE' 'I often dream about the Tyne bridge, I don't know why'

'GOT LOTS OF FOOD PART OF GNR' 'GORDON' 'LIKE THE SAGE BECAUSE MY WORK HAS BEEN SHOWN THERE'

'RUBBISH!' 'TOO MANY PEOPLE GET HURT'

'DRUG CAPITAL OF THE NE.'

'4 REHABS' 'life' '2 yrs' 'of' 'learned' 'to' 'peddle' 'to' 'S#'

'DID NOT WANT TO SLEEP IN THE TOWN CENTRE AS I KNOW AND FELT THAT I WOULD NOT FEEL SAFE. I WAS TOLD THAT TO GET 500 POINTS I HAVE TO BE FOUND BY THE HOUSING OFFICER BUT I WOULD NOT SLEEP IN TOWN!' - SB

'SAM BORN HERE' 'GET JOB CENTRE' 'SMACK TIME CARTER' 'New job love' 'Poundland' 'shoplifting' 'SMACK HEAD!!!' '4 1/2 year' 'MADE GREAT NEW FRIEND PLUS CO-WORKERS' - SCOTT

'GATESHEAD LEAVING CARE TEAM GOT ME A FLAT AT 18. LOOKING FORWARD TO STABILITY AND SUPPORT. JUST ONE HR PER fortnight' 'PROPERTY MANAGEMENT'

'GATESHEAD NO GO AREA' 'Birthplace of marcus' 'Day 22 in the Big Brother House .1.04 an. All of the housemates are in the bedroom' Bentley

'It is a mere suburb, a long, dirty lane, leading to Newcastle - a most filthy spot, containing the vilest class of society' The Marquis of Londonderry on Gateshead, 1831

'GATESHEAD HOSTEL' 'HEROIN' 'HARD' 'BY' 'S#'

'GATESHEAD LEAVING CARE TEAM GOT ME A FLAT AT 18. LOOKING FORWARD TO STABILITY AND SUPPORT. JUST ONE HR PER fortnight' 'PROPERTY MANAGEMENT'

'Gateshead Leaving Care Team' 'Civic Centre' 'social services' 'TOSSERS' - David

'Gateshead Leaving Care Team' 'Civic Centre' 'social services' 'TOSSERS' - David

'Gateshead Leaving Care Team' 'Civic Centre' 'social services' 'TOSSERS' - David

'Gateshead Leaving Care Team' 'Civic Centre' 'social services' 'TOSSERS' - David

'Gateshead Leaving Care Team' 'Civic Centre' 'social services' 'TOSSERS' - David

'Gateshead Leaving Care Team' 'Civic Centre' 'social services' 'TOSSERS' - David

'Gateshead Leaving Care Team' 'Civic Centre' 'social services' 'TOSSERS' - David

'Gateshead Leaving Care Team' 'Civic Centre' 'social services' 'TOSSERS' - David

'Gateshead Leaving Care Team' 'Civic Centre' 'social services' 'TOSSERS' - David

'Gateshead Leaving Care Team' 'Civic Centre' 'social services' 'TOSSERS' - David

'Gateshead Leaving Care Team' 'Civic Centre' 'social services' 'TOSSERS' - David

# Tyneside's Skateworlds and Their Transformation

## Production and Consumption of Participatory Post-Representational Cartographies

Jon Swords, Mike Jeffries  
[accidentalyouthclub.wordpress.com](http://accidentalyouthclub.wordpress.com)



Post-representation cartography is an approach to mapping which emphasizes the processes involved in map-making. The emphasis shifts from "the 'rules' of map design and techniques of cartographic production, and/or documenting and deconstructing the underlying ideologies and agendas of maps, to a processual perspective concerned with how mappings and cartographic design, technique and ideology emerge time and again through a plethora of practices framed within a complex discursive and material context, and the diverse, unfolding work of mappings in the world" (Kitchin et al., 2013: 481). Thus post-representation cartography is

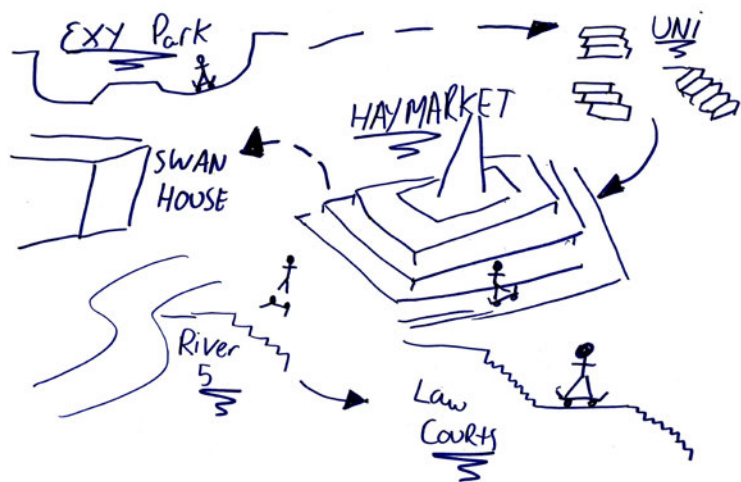

concerned with how representations of the worlds around us become maps through, on the one hand, the use of certain technologies, tropes and methodologies by cartographers (in the broadest possible sense), and on the other hand, how users unfold and recognize maps anew through their style, content and conventions. In some contexts, something which isn't traditionally thought of as a map, may thus become one because it is used as a map. In this way maps become "writerly texts" where the "purpose is to see texts as producing an open series of readings, each of which requires that the reader also be in part author of meaning" (Pickles, 2004: 174).

The map you see here is the result of a project with skateboarders to understand their appropriation of space in Tyneside, in the North East of England, undertaken in 2009-10. Our primary methodology was to ask skaters to map their worlds, but what we actually got were fascinating sketches and doodles full of insight and emotion. In a previous piece we have explained how these sketches and doodles became maps through our analysis and use as locational technologies, and were subsequently aggregated into the map you see here (Swords & Jeffries, 2015; see also Jenson et al., 2012, for insights into the activities of skateboarders). In what follows, we adopt a post-representational approach to explain how the map has unfolded to take on other forms through its use in a variety of contexts.

## Primary Uses

We originally created the mappa mundi of Tyneside's skate scene to give something back to research participants and avoid an extractive research process. We've given out hundreds to skaters, their parents, friends and other interested parties. The skaters are mainly male, under 25, and include locals and students. There are older skaters who lend experience and building skills to help improve spots such as the Wasteland. We further involved skaters in the project by giving them the opportunity to exhibit their photography and video-making alongside maps from the project in an exhibition. In this gallery context the map changes function from a tangible "thankyou" to artwork, and thus the kind of interaction with it shifts, too. The map becomes an object of beauty and contact, countering the portrayal of skaters as unruly, their world hidden from public view. The content of the map is also seen in a different light as the exhibition took place at Dance City in 2010, a publicly funded cultural institution with a curatorial role that legitimizes the work it shows. The skateworld of Tyneside, then, is not only made "official" in the production of a map by academics, but also in the context it was displayed. It thus becomes a political

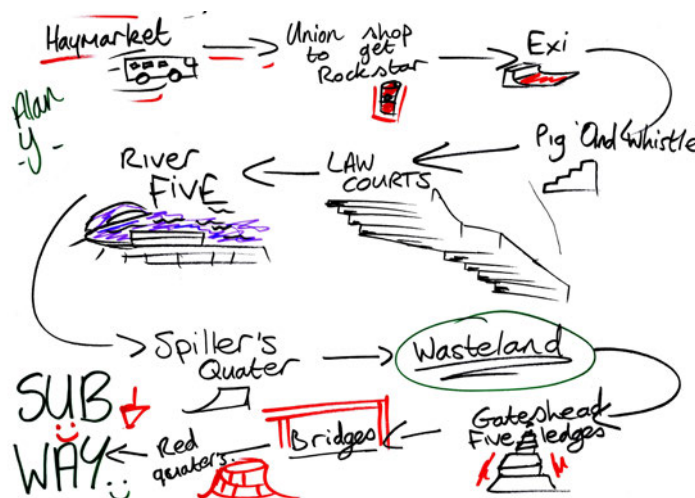

device that implicitly criticizes "authoritative" maps of Tyneside, which exclude people such as skateboarders. The physical existence of the map explicitly counters the city centre maps, which focus on either decorous heritage or contemporary consumption.

The map created an opportunity for skaters to represent and eulogize their world, giving them permission to be proud. This was demonstrated as skaters showed their parents what they had contributed and the spots they went to around the city. Exploratory processes such as this one also illustrate the role of the map as something to examine and learn from. We learnt the social dimensions of skate spots, the journeys skaters take between them, and how they are valued within the community. Skaters shared with us stories and legends of tricks of the past, and the temporal and spatial rhythms of their world. We heard of the old lady who felt safe when skaters were around, the deal between skaters and security guards at the Law Courts for access after work, and the dangers of jumping Leazes 13. The skateboarders discovered new spots, each



other and the fact that people value their presence in the city.

Like many other maps, its "mapness" means it functions as a historical record of the skate scene. The Wasteland, Leap of Faith and Library Plaza no longer exist as the buildings they were part of have been knocked down and redeveloped, so this map is the only "official" record of their location. The map was never designed as a navigational tool, although it would help to find spots, and its historical dimension adds an element of remembrance.



### Subsequent Uses: a Research Tool, a Calling Card and a Product

The map's mapness has allowed it to be mobilized in a series of other contexts. It has become desirable and useful for skaters who weren't involved in the original research. Skate scenes are very visual, and this map has become part of the scopic regime of Tyneside's skateboard community. The existence of the map is an immediate, visible explanation of what we do, its visibility inviting more skaters to join in. As our work has continued, we give out the map to participants, and it incentivizes them to take part. It shows them we are serious about them and their place in the city, and they can show others that institutions like universities are interested in their lives.

Its visual style adopts tropes from other maps of Tyneside with the curve of the river on the background layer recognizable to anyone familiar with the area and the green and yellow lines connecting skate spots reflect the design and colour of Tyneside's Metro light rail system. Even skaters who weren't part of the origi-

nal project have been exposed to it and recognize it when we use it in fieldwork. It thus acts as a calling card when working with new participants who have often heard, or seen our work.

As our research has continued we have worked with other urban sports groups. The photograph to the right shows BMXers tracing their world over the skateboarder's city. The map again shows this new group we are serious about them, and offers them an opportunity to counter what to many would be seen as a similar appropriation of the city. What is revealed in the BMXers version, however, differs in a number of ways. The most obvious is the larger territory BMXers can access in a day, their bikes enabling them to venture further afield. The scale of the spots BMXers appropriate is also larger. The size of BMX bikes and the greater speeds they are able to achieve requires long runs ups and outs to perform tricks safely.

The skate maps have also facilitated responses even in formal gallery settings where no annotations were requested. In the photograph below you can see our work exhibited at Dance City in

2014. A breakdance festival was being hosted in the venue, and a group of dancers aged 8 or 9 added themselves to the maps on display. This was a delightful surprise and indicates the map does work by itself to engage young people in mapping their city. The children pictured felt comfortable to subvert the conventions of display to engage with the mapping process.

Away from fieldwork, the map also legitimizes us as researchers in meeting with potential new backers and research partners. We can show a tangible, interesting output from a previous project which

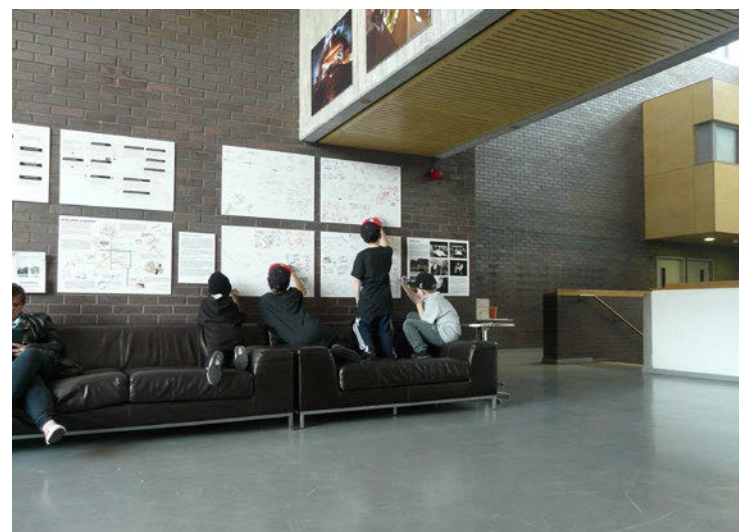



fascinates people in a way an executive summary or journal article can't. Here the map maintains its role as an explanatory tool, but it also works to show what we're capable of producing. Its mapness again helps here as the process and product are made visible, which encourages partners to explore what they would like.

To conclude this brief biography of this map, we have tried to trace the different forms it takes as it unfolds while people use, edit and re-inscribe it with meaning. It has become a locational tool, a historical record, artifact, work of art, calling card, a thankyou, an agent in itself and a prompt for discussion and exploration. It has taken on these forms in a variety of sites, including the places it depicts, within cultural institutions, universities, imaginations of viewers and now in an atlas. It has been unfolded and refolded to become a legitimatizing tool for us as its original authors as well as for skaters and others as they re-inscribe it with new meanings. Now, in its current context, we hope you, the reader, will find your own meaning in it.

#### References

- Jenson, A., Swords, J. & Jeffries, M. 2012. The Accidental Youth Club: Skateboarding in Newcastle-Gateshead. *Journal of Urban Design*, 17(3): 371–388.
- Kitchin, R., Gleeson, J. & Dodge, M. 2013. Unfolding Mapping Practices: A New Epistemology for Cartography. *Transactions of the Institute of British Geographers*, 38(3): 480–496.
- Pickles, J. 2004. *A History of Spaces: Cartographic Reason, Mapping and the Geo-Coded World*. London: Routledge.
- Swords, J. & Jeffries, M. 2015. Tracing Postrepresentational Visions of the City: Representing the Unrepresentable Skateworlds of Tyneside. *Environment and Planning A: Economy and Space*, 47(6): 1313–1331.

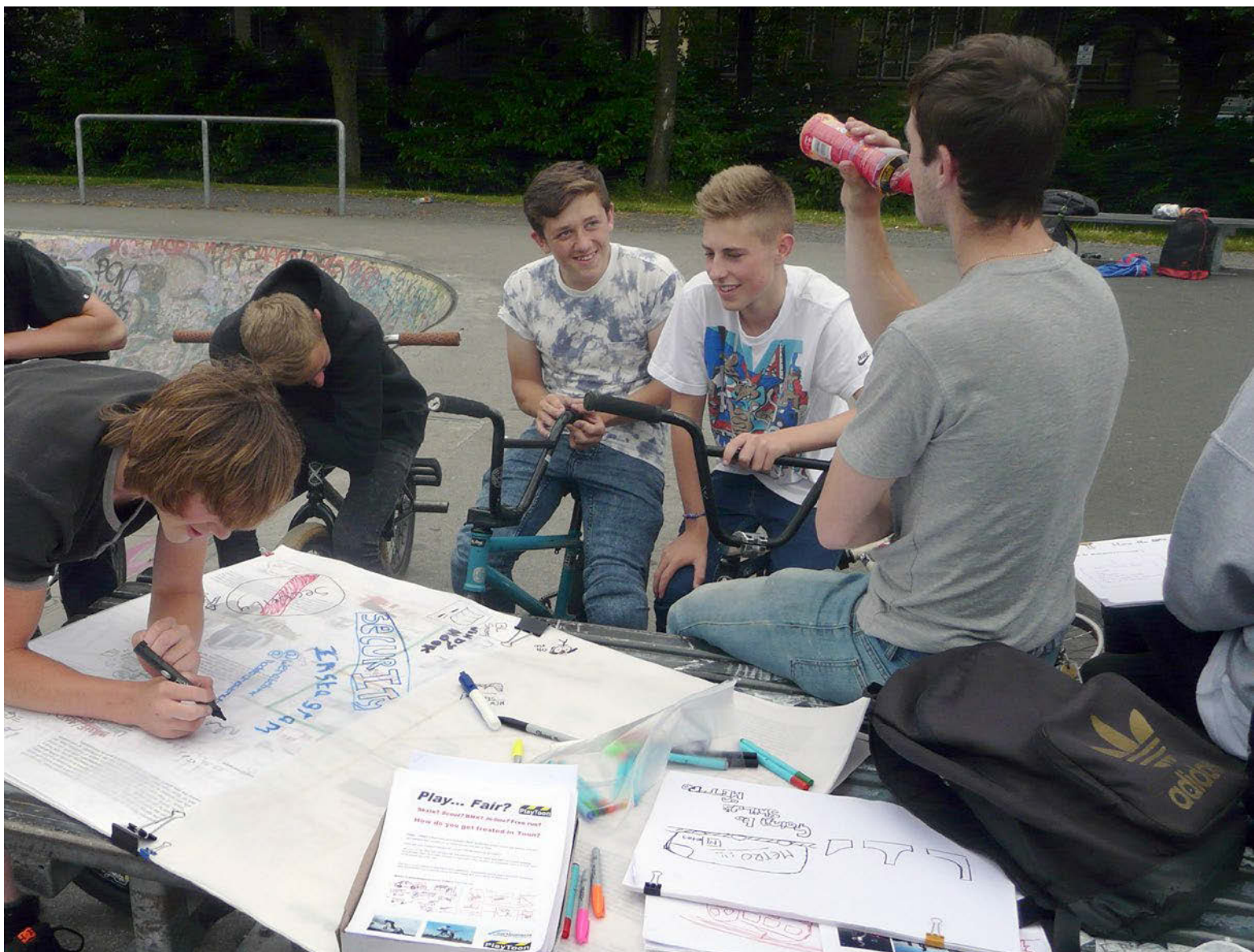

# play:space newcastle

For some, skateboarders are a public nuisance, vandals, the rebellious youth. For others, skateboarders portray freedom, enjoyment and creativity. However you consider them, skateboarders change the way we understand the places they appropriate within cities. Their actions reject normative uses of urban space as they flip, grind and ollie their way through a city not always visible to the layperson. Using spaces rejected by other social groups skaters transform the built environment into playgrounds and arenas: an innocuous set of steps becomes a beginner's rite of passage, a ledge is transformed into an grind block, a bank becomes a kicker...

We were interested to better understand how skateboarders use, explore and transform parts of Newcastle upon Tyne. We spoke to as many skaters as we could find and asked them to map their favourite spots. We could have written a report or journal article to tell everyone what we found, but not many people would read that. Instead, we created this skater's mappa mundi as an attempt to summarise what we found.

Contemporary Haymarket appears to be the least skated spot of the most popular sites highlighted by participants. Until recently, skateboarders would frequently use the steps and flat surface for tricks. In 2002, however, a by-law was passed excluding skaters from the area which included the threat of a £500 fine for transgression. It is not only since this restriction has been imposed that Haymarket has been the source of marginalisation, and social resistance. The participants revealed that they have faced a longstanding effort to maintain skateboarding at Haymarket. Respondent 4 told how he "used to get a lot of grief off the police". Despite this, skateboarders have always presented some form of resistance by continuing to skate and then "run away" when the police arrived. Borden suggests this temporary appropriation of space for a matter of minutes, which is repeated over weeks, is evidence to suggest that there is conflict between the social groups.



"Haymarket was the central spot. It's where you'd hook up"

Session - on ::



Leazes 13

Haymarket

Exi Park

Smooth Park

Pig

Monument

Pig and W

Gap2Bent

River 5

Newcastle College

"First thing I ever kickflipped"

"Who was the first person to ollie that set like? Jamie or someone?"

Leazes 13/gap

"Gary and Kurt were first to try it from what I know. Gary ended up cracking his head and having to have it stapled up. The first to I and it was Neil, then Kurt did it and I think the cougar has landed it (not sure)"

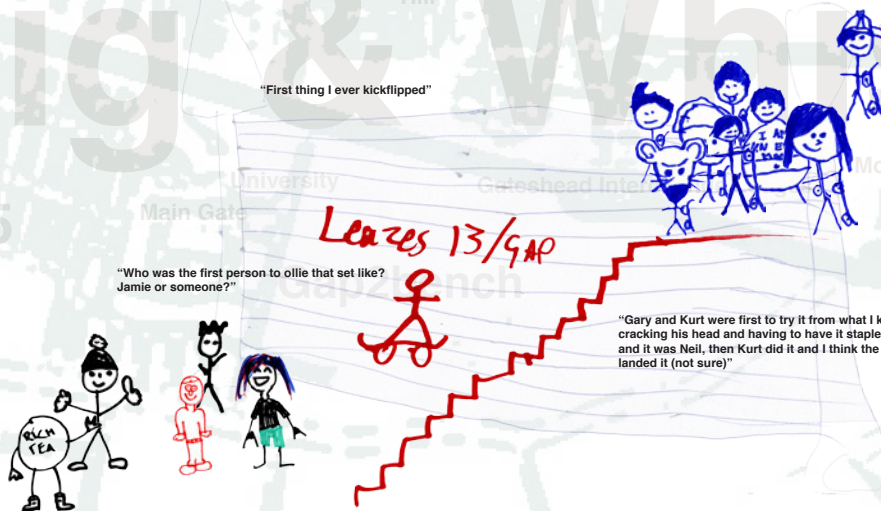

Native



Where to go for food?

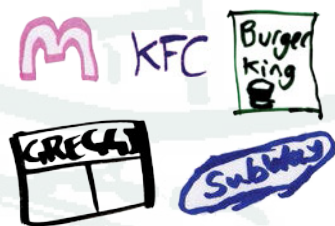

The Law Court

Opening Times: Weekdays 6 till late and all weekend

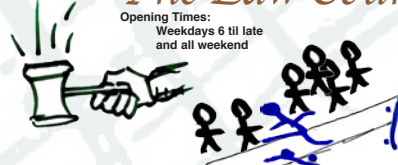

In his book about architecture and skateboarders, Iain Borden suggests skateboarders appropriate space by offering a creative re-working of its temporal and spatial characteristics. This is most clearly illustrated at the Law Courts. Skateboarding could not be further away from the intended use of the building, but the continuous appropriation of the double set of eight stairs over a number of years has created a hybrid space. During the day the steps provide lawyers access to the Court, in the evening they function as obstacles for tricks. The skateboarders, however, are aware they are not the dominant force within this informal relationship. To ensure the Law Courts remains a viable skate spot older skaters educate their less experienced counterparts about the access arrangements.

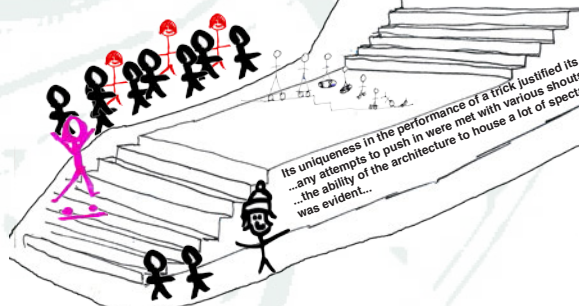

Exhibition Park is the fifth most popular spot highlighted in the maps. 'Exi' was built in the spring of 2004 and was intended to give the youth a space which was away from the commercial areas. It was constructed to relieve the pressure put on public space by young people. The skate park allowed designers to exclude skateboarders even further within the city centre through anti-skate measures, as they now have a "place" of their own. In the choice of location, skateboarders were built out of the city and pushed to the peripheries. The prescriptive nature of Exhibition Park, the lack of 'buzz' from many separate obstacles, and the proliferation of non-skaters means the very space created for skateboarders is seen as exclusionary.



# WASTELAND

## Wastelands

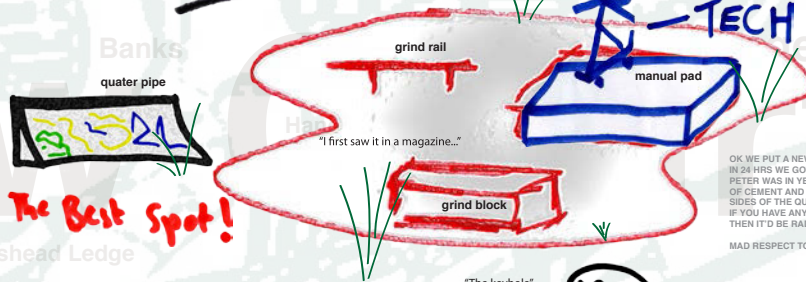

OK WE PUT A NEW POT IN THE SHOP FOR CEMENT MONEY. IN 24 HRS WE GOT £12. PETER WAS IN YESTERDAY, HE RECKONS £120 WILL GET A ERTHA KI LOAD OF CEMENT AND FINISH THE MANNY PAD, NIPPLE AND SIDES OF THE QUARTER ETC. IF YOU HAVE ANY SPARE SHRAP AND SKATE THE WASTEGROUND THEN IT'D BE RAD IF YOU CHIPPED IN. MAD RESPECT TO ALL INVOLVED IN BUILDING!

"Everything you could want to skate..."

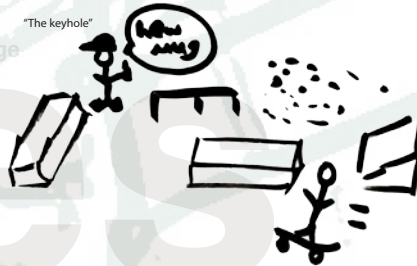

The Heaton Wasteland is another example of a creative re-working of space. The derelict area of land is a space rejected by most of society, but annexed for the city's skate scene by its use as a summer playground for skateboarders. In an entrepreneurial approach to ensure its enhanced use, skaters have set up a materials fund to help purchase concrete and tools to build new ramps, rails and blocks. The area is to be built on soon, but as one skater put it "We've had it for ten years, we'll just find somewhere else."

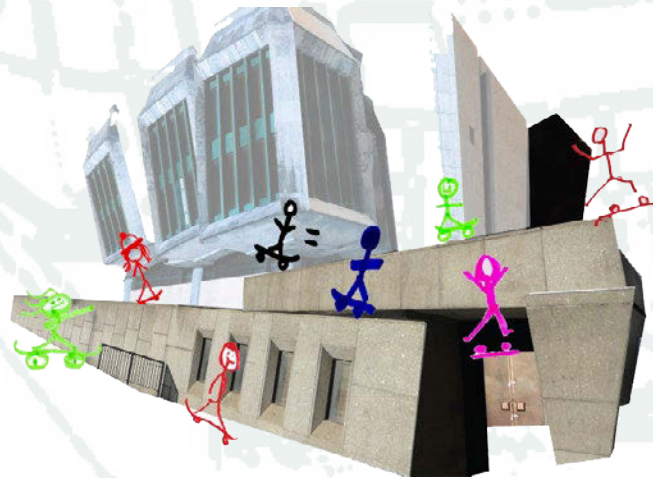

The appropriation of Five Bridges has produced a contrasting outcome to that of the Wasteland. Whereas both locations have been used by skateboarders for many years, Heaton is to be destroyed whilst Five Bridges has been transformed into a legitimate skate location recognised by Gateshead Council and the police. The temporal patterns of appropriation at Five Bridges contrast the Wasteland's: Heaton is used in the summertime, Bridges offers skaters somewhere to go all year around, no matter the weather.

# BRIDGES

...used by skateboarders because of its ability to shelter them from the rain



"People don't get mugged or stabbed with hypodermis there when skaters are occupying the spaces."

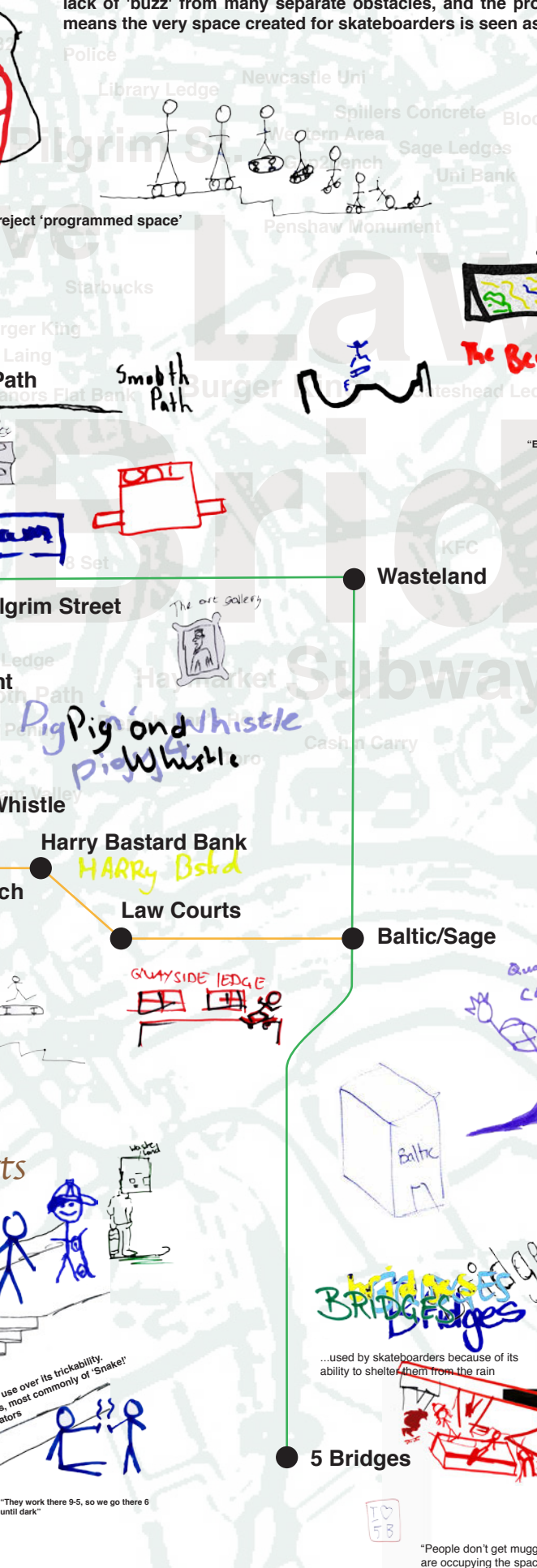

# Far Rock

## AnneMarie's Mental Map of New York

Aaron Reiss

[aaronreiss.com/far-rock](http://aaronreiss.com/far-rock)

This map is based on interviews with AnneMarie, who, at thirteen years old, was struggling with teen pregnancy and her unexpected success as a young movie actress. AnneMarie's story was the inspiration for Hannah Weyer's novel *On The Come Up*.

The map depicts Far Rockaway, the isolated neighborhood on the outskirts of New York City where AnneMarie grew up. I wanted the map to reflect the isolation of the place as AnneMarie imagined it.

To do that, I started by asking AnneMarie to make a few drawings of her neighborhood from memory. For one, I asked her to focus on personal landmarks and how they related to each other geographically. For another, I asked her to map common journeys she made. Lastly, I asked her to map the neighborhood's boundaries, edges and places of entry and exit.

Going over her drawings, I saw that her routes and trajectories would often hit common obstacles (the Nassau Expressway, the coastline, large government housing complexes, etc.), which forced her to turn or end her journey. As a young girl, AnneMarie rarely had cause or opportunity to leave Far Rockaway, and these obstacles became boundary lines. The map beyond these borders starts to lighten, and eventually the buildings dissolve into a void. AnneMarie assumes that the world beyond Far Rockaway is a lot like her own, but she is not exactly certain what is beyond.

The map that I drew imagines Far Rockaway as a kind of island anchored to the world by a single piece of coastline. The neighborhood itself shows non-descript patterns of structures – the faceless buildings that don't much concern or interest a child as they move along their established routes to school or to the corner deli. Landmarks that give AnneMarie's personal map its reference points punctuate the patterns: the homes of friends and the major social institutions that define her life.

Far Rockaway sits on a peninsula at the outer boundary of New York City, and the A Train is the only subway that reaches it. Far Rockaway is the last stop on that line. As a young girl without a car, the A Train was the only way AnneMarie really left her neighborhood. I drew the A Train as the only reference to Far Rockaway being part of the larger New York City, as an umbilical cord that connects the socially isolated area to the rest of the city.

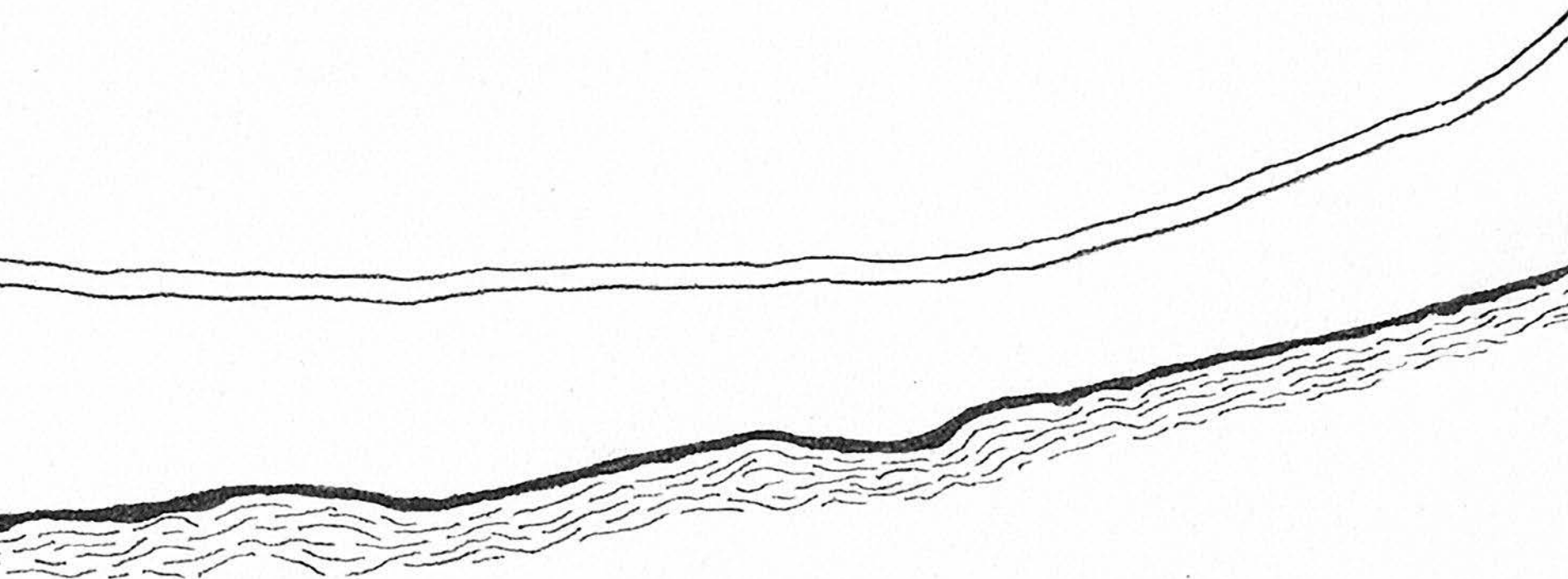







# Counter-Cartographies as Self-Reflection

# Information Overload

## From the Map to the Ground, and Back

Elisa T. Bertuzzo, Günter Nestl<sup>1</sup>

habitat-forum-berlin.de





1-2-3 – it looks so harmless on the map: a thin line that runs eastwards, then takes a sharp 90-degree turn northwards and again 90-degrees eastwards up to the edge. Yet on the ground, the line is a concrete wall, built to demarcate the boundary between two worlds, the "legal" and the "illegal", the accepted and the barely tolerated. That these boundaries are merely fictional becomes evident once you take a walk along and then cross that wall. Because the "legal" neighbourhood, with its rusty huts leaning on decrepit-looking apartment buildings and the children playing barefoot on the roads, doesn't actually differ from what you'll see on the other side – only that the majority of its residents prefer to take care of their everyday purchases at the shops and often send their children to the schools of the neighbourhood behind the wall. On that side, the same one- and two-storey buildings made of corrugated iron create an even more dense pattern, and the roads are only partially paved. When taking a closer look, you realise how the construction of the wall must have cut certain houses and courtyards in two, and considering the number and shape of the tin sheets fixed onto it in order to form roofs and carve out rooms, you may conclude that this has happened some time back. Why have the two neighbourhoods been separated? Who built that wall? And what does it all have to do with our map? *From the map to the ground and back*, reads its subtitle. It points at the work process from which the map emerged and at its double function: to represent social relations and personal memories, experiences, insights, and simultaneously encourage self-reflection. But I'll better explain one thing at a time.

The neighbourhood behind the wall, surrounded on all other sides by what remains of a former canal filled with detriments and illicitly disposed construction waste, is Karail Basti, one of Dhaka's largest and oldest self-organised settlements. We – a loose network of students and researchers coordinated by the non-profit Habitat Forum Berlin – have been studying the circumstances and preconditions of its social production since 2009. It is widely known that Bangladesh, low-lying on the world's biggest delta, is exposed to serious risks vis-à-vis global warming and is prone to seasonal floods and land erosion, due to both the long monsoon periods and ill-implemented river embankment projects. When people are forced to leave their villages in the aftermath of related calamities or out of sheer poverty and migrate to Dhaka, the majority ends up in one of its numerous *basti*: residential settlements of spontaneous, that is unplanned, origin ("slums", as they are pejoratively called by many). How do they organise themselves there? How do they ensure the provision of basic services – water, electricity, roads, gas – which the authorities generally refuse to deliver on grounds of the illegal land occupation? How far does self-organisation reach, and where does its scope end? These are the main questions we asked ourselves at the beginning of the research. The sketches and diagrams placed around and inside the "proper" map offer answers to some of them on the basis of data gathered within a baseline study in 2012, 2013 and 2014. At the time, we were mainly concerned with issues such as housing conditions and production, built infrastructures, as well as public amenities (open spaces, mosques, market facilities, schools, etc.) in Karail. Progressively, we embedded all information into a map of the settlement, drawn on the basis of its Google Earth-picture

of 2013 and amended through on-site verifications, discussions and workshops with selected groups of inhabitants.<sup>2</sup>

Our decision to fill a map with the fieldwork evidences (while also reflecting on it in articles for newspapers and academic journals, field reports, a blog<sup>3</sup>, etc.) had first of all a practical reason: We felt that a visual outcome would be easier to review with the inhabitants of Karail, whose language, Bengali, few of us could speak. The second reason will resonate with other practices of counter-mapping collected in this book. We wanted to oppose official maps of

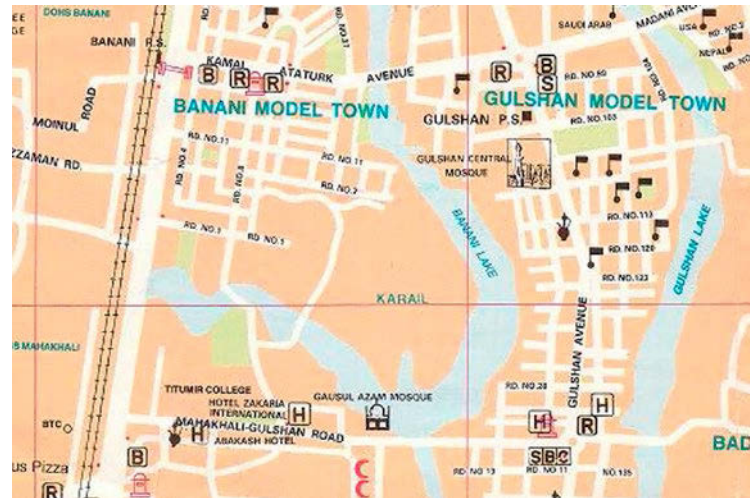

Dhaka, in which the area covered by Karail Basti was (and to this date is) portrayed as an empty spot, a state-of-the-arts map, in order to call attention to the existence and everyday struggles of its more than 100,000 inhabitants. Like many others in this city, they are literally made invisible by the state and its overall anti-poor attitude in questions of urban development and planning. Thereby, the continuous shifts from the map to the ground and back that were required to amend the Google Earth-picture confronted us with the benefits, but also the limitations of mapping. Depending on the perspective, a satellite image reveals overwhelmingly much, or very little of Karail Basti. You are astonished by the density of dwellings only to find out, once you are at someone's home for a tea, that the single housing units are subdivided into even smaller rooms and lent to respective sub-tenants: one family, one room – this is the standard. You are proud you've located each and every mosque only to be asked why you haven't recorded the trees, palms and especially the banyan trees, on whose branches benign as well as malign spirits dwell, as the local residents say. You get familiar with the whole *basti* to realise when returning after six months that your favourite spot, the overall fabric of a particular area, and even the population structure, have changed considerably due to the replacement of tin structures with brick buildings.<sup>4</sup> In other words, the plural views on what the map ought to show and the steady transformations we came across thanks to the personal interactions and the *longue durée*-approach of our study (we'd chosen to cover at least ten years of developments in the settlement) presented us with a dilemma: We would either have to make our map more general and abstract or accept that it may become outdated in no time.

In spite of this probably well-known limitation we could see some of our main goals coming to fulfilment. Variations of the



main map helped us to tackle increasingly complex questions related to spatial development with individuals and groups of residents; moreover, from time to time, Karail's community-based organisation (CBO) leaders used them in their ongoing struggle for recognition and legalisation of the *basti*. It was during a meeting with them, back in 2012, that we discovered their *samajer manchitra*, community maps (see first map at the end of the article). One of the main differences between NGOs that pursue a rather emancipatory programme and those that simply distribute aid is that the first encourage community-based organisation among members of the disadvantaged social groups. The activists of DSK, a prominent representative of this kind of NGOs in Bangladesh,<sup>5</sup> are trained to turn development projects, generally focused on infrastructural upgrading, into occasions to collaborate with the inhabitants, foster their networking and thus "help them to help themselves". This somewhat inflationary slogan, taken seriously, means that the aim of an NGO should be to make itself unnecessary in the long run if not sooner. It will accompany the concerned groups in the process of detecting their own needs and forging coalitions so that they become able to carry out projects and campaigns by and for themselves. Mapping together facilitates such a process, as shared problems are identified and possible solutions emerge "naturally", by means of comparison, and from an occupation with space that conflates its physical and social factors in the drawing. It stood out that the CBO leaders had been producing one or two community maps per year since 2009, initially under the guidance of DSK activists, later independently, and that the regular exercise had increased not only their understanding of

technical and infrastructural requirements, but also their sense of "ownership" of the settlement. They also performed regular countings of the population: That their census' results matched with our own estimates was all the more important, as most statistics circulated by the state, but also by NGOs and international agencies, are strongly flawed.<sup>6</sup>

So, now we knew that Karail's inhabitants, and in particular its CBO leaders, were able to produce and use maps in order to plan and execute localised development interventions. This gave us one more reason to try and push our mapping practice to a new level, experimenting with personalised expression forms and mixing the geographic logic with other logics. The inhabitants' community maps acted as an inspiring model for this endeavour: They were highly synthetic yet innumerable stories emanated from them nonetheless. We reckoned this had to do with their collective and manual generation and with an approach that didn't at all pretend to explain or reduce the complexity of relations and relationships, structures and negotiations so deeply entrenched in Karail's everyday life. Similarly, our interpretation ought to pass on this information poetically and function *poietically*, that is, trigger an ideally infinite generation and regeneration of observations according to changing perspectives. In short, the *samajer manchitra*



compelled us to turn mapping into (a way of) storytelling. This is the radical lesson our Information Overload map entails: Stop counting; start talking with the inhabitants of a place. Do it excessively. And while searching for words to name what your ears resonate of, what you've got before your eyes and what your memory and body won't ever forget, you'll notice the place is already speaking to you with its own voice.

"And, what about the wall?", you will ask now. The wall, a symbol of how the powerful would like to regiment space in a city whose population growth is tagged the fastest of the world and where land prices are constantly rising, has been standing between Karail and T&T Colony until today. It is our hope that, also looking at this ridiculously thin line on the map, people on both sides will soon dismiss their fear of distinctions, such as "legal-illegal", forged only in order to retain the status quo in a city deserting its duty to cater to all inhabitants, and jointly demand a fair redistribution of living space.

#### Endnotes

1. Text by Elisa T. Bertuzzo, Photos by Günter Nest
2. Ours is a no-budget study that runs thanks to each participant's personal and political commitment, scientific passion and friendship. The local teams were built by Louisa Scherer, Paul Klever, Farhana Kaniz Sharna (2012), Abdul Kader Khan (Komol), Anna Sauter (2013), Marian Knop, Lisa Lampe, Tamanna Siddiqui (2014), and guided by Günter Nest and Elisa T. Bertuzzo.
3. Cf. [habitat-forum-berlin.de/page/adda-discourses.html](http://habitat-forum-berlin.de/page/adda-discourses.html)
4. Building with bricks instead of corrugated iron makes it easier to pile, onto the ground floors, mezzanines and first floors. Whereas the mezzanines are generally allotted to single men, especially cycle-rickshaw pullers and construction workers, the tiny rooms on the first floors are being increasingly rented out to students, young couples and professionals.
5. Acronym for Dushtha Shashtya Kendra, [dskbangladesh.org](http://dskbangladesh.org). Habitat Forum Berlin has collaborated with this organisation since 2014.
6. In particular, the government's census downsizes the population of Karail and other basti, whereas most NGOs (local and international) and donor agencies tend to overestimate the numbers, clearly to cater to respective agendas.

#### Illustrations

The map INFORMATION OVERLOAD – From the Map to the Ground and Back was created by Günter Nest, Marcus Jeutner, Paul Klever, Anna Sauter, Louisa Scherer, and Elisa T. Bertuzzo.

The reproduced community map from 2013 was drawn by Mohiuddin with inputs from Selina, Md. Mannan and Shahid Gazi.

আমাজি  
কডা  
৩৫



# কমান্ডিং

## বাস্তু

২০১৩/১২/০১২

**চিত্র সমূহ**

- = বাড়ি বাড়ির ঘর = ২০০৭০
- = CBO ঘর
- = প্রতিবন্ধীদের ঘর
- = গ্রাম সমূহে পাথরখানা
- = সুন্দর/অ-মারাত্মক পানি
- = মসজিদ = ৭ টি
- = পানির পোতা = ২ টি
- = স্কুল = ২২ টি
- = ড্রাম
- = গলি/গাটা
- = পানির পাইপ
- = কবরস্থান
- = বাড়ি কল্যাণ মন্দির = ২ টি
- = খুয়া = ১৫০ টি
- = চৌকি
- = বিদ্যায় কেন্দ্র = ১ টি

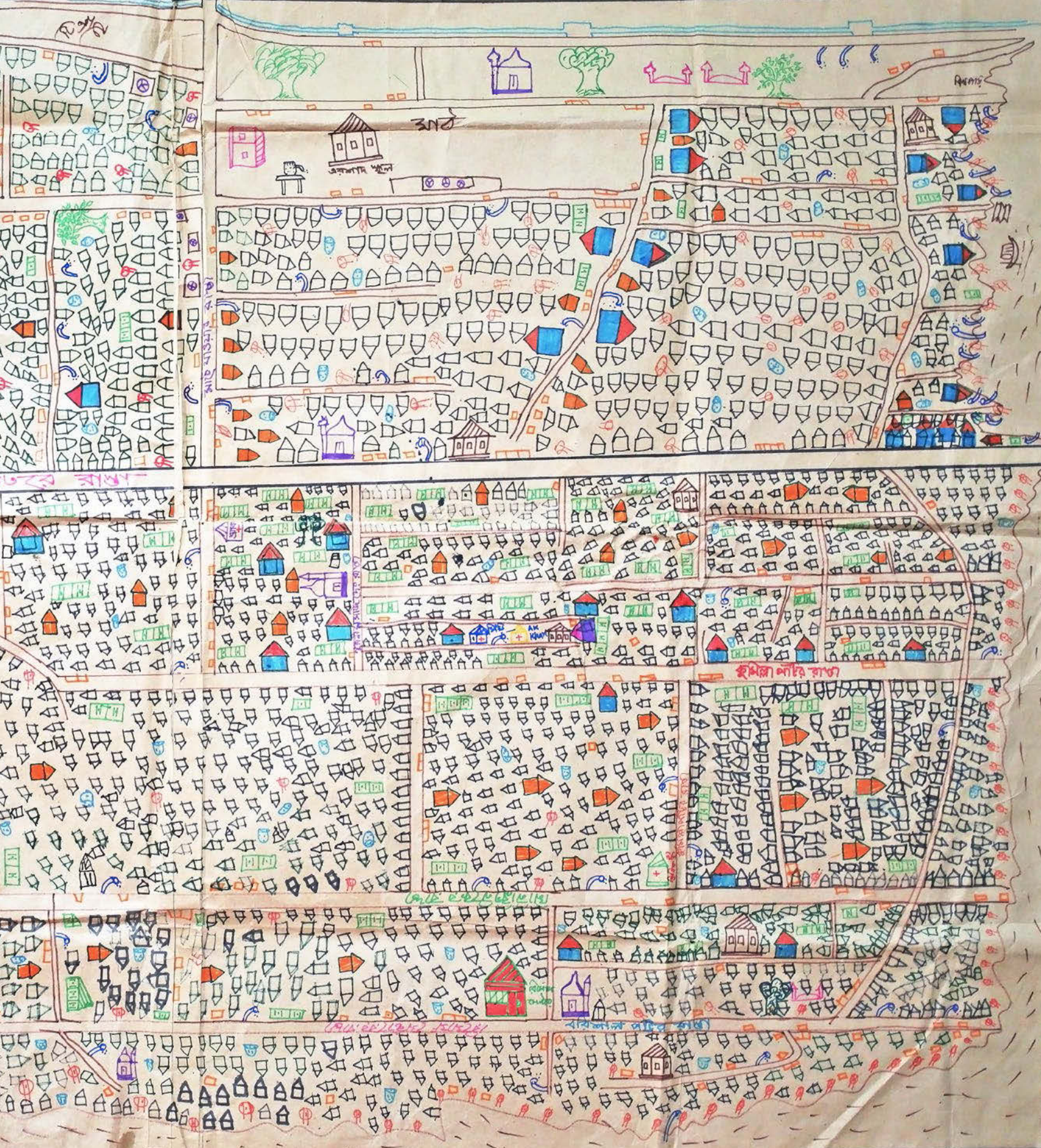

- = বিদ্যা
- গ্যারেজ = ৪০
- = জাপ
- সেমিটোরী কন = ৬ টি
- = খোরকা
- বিবি ক্লিনিক
- = ডিটি
- স্যাটেলাইট
- ক্লিনিক = ১ টি
- = A K-KH
- = টে
- সেভার = ৪ টি
- = বাজ
- ২ টি
- অ-কুপ্র২৭
- সহায়
- ১। সেন্টার
- ২। জাতি
- ৩। খোরকা
- ৪। গ্যারেজ
- ৫। মসজিদ
- ৬। স্কুল
- ৭। পানির পোতা
- ৮। পানির পাইপ
- ৯। জাতি
- ১০। জাতি
- ১১। জাতি
- ১২। জাতি
- ১৩। জাতি
- ১৪। জাতি
- ১৫। জাতি
- ১৬। জাতি
- ১৭। জাতি
- ১৮। জাতি
- ১৯। জাতি
- ২০। জাতি
- ২১। জাতি
- ২২। জাতি
- ২৩। জাতি
- ২৪। জাতি
- ২৫। জাতি
- ২৬। জাতি
- ২৭। জাতি
- ২৮। জাতি
- ২৯। জাতি
- ৩০। জাতি



HOUSE ROOMS ACCOMMODATION LIVING HOUSE BUILDING NARROW CORRIDOR WITH ROOFS TWO FLOORS HUT CORRUGATED KITCHEN SHARED KITCHEN FACILITIES ROOMS HUT RESIDENTIAL HOUSES BASED ON RURAL DESIGN ACCOMMODATION COURT YARD STRUCTURE DWELLING HOUSE SHARED SPACES COURTYARD HOUSES BASED ON RURAL DESIGN CORRU GATED IRON HUT SCHOOL RICE SHOP SHOPS HOUSES TEA STALL MEETING ROOMS HOUSES BASED ON RURAL DESIGN ACCOMMODATION COURT YARD STRUCTURE DWELLING HOUSE SHARED SPACES COURTYARD HOUSES BASED ON RURAL DESIGN CORRU GATED IRON HUT SCHOOL RICE SHOP SHOPS HOUSES TEA STALL MEETING ROOMS HOUSES BASED ON RURAL DESIGN ACCOMMODATION COURT YARD STRUCTURE DWELLING HOUSE SHARED SPACES COURTYARD HOUSES BASED ON RURAL DESIGN CORRU GATED IRON HUT SCHOOL RICE SHOP SHOPS HOUSES TEA STALL MEETING ROOMS

HOUSE ROOMS ACCOMMODATION LIVING HOUSE BUILDING NARROW CORRIDOR WITH ROOFS TWO FLOORS HUT CORRUGATED KITCHEN SHARED KITCHEN FACILITIES ROOMS HUT RESIDENTIAL HOUSES BASED ON RURAL DESIGN ACCOMMODATION COURT YARD STRUCTURE DWELLING HOUSE SHARED SPACES COURTYARD HOUSES BASED ON RURAL DESIGN CORRU GATED IRON HUT SCHOOL RICE SHOP SHOPS HOUSES TEA STALL MEETING ROOMS HOUSES BASED ON RURAL DESIGN ACCOMMODATION COURT YARD STRUCTURE DWELLING HOUSE SHARED SPACES COURTYARD HOUSES BASED ON RURAL DESIGN CORRU GATED IRON HUT SCHOOL RICE SHOP SHOPS HOUSES TEA STALL MEETING ROOMS HOUSES BASED ON RURAL DESIGN ACCOMMODATION COURT YARD STRUCTURE DWELLING HOUSE SHARED SPACES COURTYARD HOUSES BASED ON RURAL DESIGN CORRU GATED IRON HUT SCHOOL RICE SHOP SHOPS HOUSES TEA STALL MEETING ROOMS

HOUSE ROOMS ACCOMMODATION LIVING HOUSE BUILDING NARROW CORRIDOR WITH ROOFS TWO FLOORS HUT CORRUGATED KITCHEN SHARED KITCHEN FACILITIES ROOMS HUT RESIDENTIAL HOUSES BASED ON RURAL DESIGN ACCOMMODATION COURT YARD STRUCTURE DWELLING HOUSE SHARED SPACES COURTYARD HOUSES BASED ON RURAL DESIGN CORRU GATED IRON HUT SCHOOL RICE SHOP SHOPS HOUSES TEA STALL MEETING ROOMS HOUSES BASED ON RURAL DESIGN ACCOMMODATION COURT YARD STRUCTURE DWELLING HOUSE SHARED SPACES COURTYARD HOUSES BASED ON RURAL DESIGN CORRU GATED IRON HUT SCHOOL RICE SHOP SHOPS HOUSES TEA STALL MEETING ROOMS



daughter, lawyer. at the in dhaka is a disap- a job. it huge mon- t was the m public hours a day, for example as helpers in their families' shops, as rickshaw pullers or as collect from the streets of gulshan and banani plastic bottles, bags, construction wa materials. this is why children, and especially this latter group, are well informed ab guidance was indispensable while making first steps in karail. among the first thin mosque. all their families, they said proudly, contributed to the fund-raising f committee"). ar'ju-apa. one of the most enjoyable things remain the chats with my s how hard those days used to be, at the beginning, when they arrived from nohakha their hands and their hunger, the twins that just crawled. how many times they w midnight with a cup of boiled rice in their bellies. alamgir, her husband was emp but the pay wasn't enough. so one day, she left the babies at a neighbour's and houses of the rich... she recalls how she joined an NGO programme, learnt sewin first sewing machine. every day, after 12 hours work, they stayed up late, she se of the boys. how many struggles, how much sacrifice. and the mastan, the mafia threatened them all to destroy their huts unless they'd pay. a week's savings were illegal, all of them knew, who would protest? where? the police wasn't be another loan, 20,000 bucks from grameen bank, she installed a tailor sh vegetable market. those days, nobody in the settlement could afford ha clothes. but she mended worn-outsaris, shirts, sawar kamiiz. and when they

# C/Artographies of Positionality

Or How We Try to Situate Ourselves as a Working Group in Academia

Working Group Critical Geographies of Global Inequalities, University of Hamburg





*"This is a map! Is it? It's a drawing! Is it really a map? It is!"*

## Welcome Confusion!

Confusion helps us to get our thoughts, emotions and boundaries moving and opens spaces for discussions and reflections on multiple levels. Being engaged as scholars in a neoliberalizing academy, we participate in the production and distribution of knowledge by writing articles about other people's lives, by researching (in) the global south, by giving talks, etc., on a regular basis. These practices generate a lot of confusion and challenges. As an academic working group under the label "Critical Geographies of Global Inequalities" (CGGI) we collectively decided on welcoming these processes of confusion. Inspired by joint readings and discussions of works on feminist slow scholarship (Mountz et al., 2015), decolonizing methodologies (Smith 2012), cultivating practices of joy (Kern et al., 2014) and wellbeing within academia (Mullings et al., 2016), we began to deal with questions around power relations and knowledge production and how we as a working group are situated within these, but also how we position ourselves to these.

## Art Meets Cartography – Artography?

While trying to reflect on our own theoretical and methodological research practices individually and at the same time wanting to develop a stance as a collective, we quickly reached the limits of the conventional range of scientific practices. We realized that at this point thinking, discussing, and writing as our standard tools to acquire new perspectives on different themes was not enough for us. This is why we started to include creative and visual elements into our reflection processes. It became clear that engaging creatively with our own work also made it possible to deal with complex subject-related issues as well as theoretical questions and methodological approaches simultaneously on one piece of paper. In collaboration with Neele Bunjes<sup>1</sup> – a Hamburg-based artist and illustrator – we started a collective artistic mapping process based on the interdependencies of art and scientific knowledge production. Moving between the steps of reflection, imagination, visualization, representation and discussion over and over again, this map represents the current intermediate result of our discussion, which is part of the ongoing negotiation of our positionalities as well. It is therefore neither fixed nor final.

Within our working group we have multiple interests and positionalities. Subsequently we need to negotiate between different regional foci, subject matters and methodological approaches. Furthermore, our theoretical perspectives range from political ecology, poststructuralism, integrative geographies, global urban research to decolonial feminism, to name just a few. In order to accommodate these multiple aspects, the map is illustrated in a style of "hidden objects games". The different puzzle pieces represent this diversity on different layers; all the pieces of the puzzle are related through methodological tools, theoretical perspectives, subject-related aspects, etc., thus creating one whole picture and putting "us" in place. Without going into detail of the illustrated elements, we want to briefly highlight three dimensions of representation and their role in mapping our working group's positionalities.

## Putting Our Cards on the Table

### Table

The background of the illustration shows the surface of a table. What you cannot see is that this table is located in an office in a German university building surrounded and used by a mainly white, privileged group of academics. This table is not any table but the central meeting point of our working group. Sitting around this table, we work, chat, discuss, have coffee or tea (hence the cups), share ideas, laugh and cry. Thus, it is us looking at the table but at the same time we are also part of the picture in which we find ourselves visualized and (re)presented – e.g. at the speaker's desk or in the figure that is drawn by someone and simultaneously about to draw itself while still reflecting on its own drawers in the head. What is on the surface is therefore the result of multiple power relations around that table, negotiating, among other things, categories of power differences, positions in academia and the limits of reflection(s).

### Topics

The visual elements on the surface represent selected topics that we consider relevant for the map. The different subject-related puzzle pieces highlight collective interests within the working group, such as different forms of knowledge production, impact of power relations or inequalities and resistance. However, it is not only about what actually comes up but also about how these topics are being represented from our perspective as European academics and put into context visually within the map. Who speaks, who acts, what does a scientist look like, how can we visualize othering processes without reproducing visual stereotypes? How do you depict water as a society-nature relation? And so on.

### Tools

The presence of tools like the needle, the pen and the rubber illustrate the working group's active role in defining and framing contents within knowledge production by also questioning them at the same time. On the one hand, we "stitch" together perspectives and topics while, on the other hand, it may involve drawing lines or making them invisible. Different theoretical perspectives (glasses) highlight certain aspects more than others, and different scales (magnifying glasses) remind us of (hi)stories which are inscribed into our bodies and thus shape our positionalities as researchers and as individuals. These tools help to point out and to reflect on the researchers' impact in the making and unmaking (masking and unmasking) of knowledge.

## Negotiating Positionality Visually

Mapping our working group involved and still involves a profound reflection of our individual and collective practices of doing geography. Presenting ourselves as a collective to others through this map can be understood as an effort to withstand current tendencies of individualization in science (my "Hirsch-Index" is bigger than yours!). It is also an attempt to follow calls for the decolonization of knowledge production. We consider taking the time to reflect and rethink our own entanglements within power relations in the academic universe as a first essential step within this process.

The creative approach to the negotiation process enhanced our ability for reflection. The visualization not only provided space for connecting different forms of knowledge (e.g. embodied, creative, theoretical, etc.), it also revealed prejudiced hidden mechanisms of imagination that affected our representations of things, people and beings. Setting out to create a critically engaged, reflexive, multifaceted map of our working group, it turned out that our imagination was not so diverse after all. An early version of our visualization of all persons pictured on the map represented a heteronormative society as white, adult, able-bodied, although in reality we work with all different kinds of people. Representations of diversity only became a question through the process of visualization itself. It revealed stereotypes in knowledge production as, for example, people of color were placed within "indigenous knowledge" while the scientist was depicted as an old white man giving lectures. Since this kind of visualization represents dominant global inequalities and hierarchical structures in academia, this could also be read as a critique, but at the same time it runs the danger of reproducing these power relations we actually want to overcome.

Bringing collective cartography and art together in a positionality-map allowed us to present different dimensions of negotiation on an equal level without prioritizing theory over subject and practice over reflection or vice versa. Processes of visualization called for a more careful engagement with knowledge production and imagination. Yet, the map is open for discussion and different readings for everyone, full of ambiguities and incomplete in its meanings. Every time we look at it, something else comes to the fore and demands interpretation and explanation. Every time the answer is a different one for each of us, since we and our positionalities are not fixed and our ability to reflect will hopefully grow.

So, yes, it is a map, perhaps not in a conventional geographic sense but in an ideally (non-)materialistic and relational way, and yes, we are still confused.

## Endnotes

1. neele-bunjes.de

## References

- Kern, L., Hawkins, R., Falconer Al-Hindi, K. & Moss, P. 2014. A Collective Biography of Joy in Academic Practice. *Social & Cultural Geography*, 15(7): 834–851.
- Mountz, A., Bonds, A., Mansfield, B., Loyd, J., Hyndman, J., Walton-Roberts, M., Basu, R., Whitson, R., Hawkins, R., Hamilton, T. & Curran, W. 2015. For Slow Scholarship: A Feminist Politics of Resistance through Collective Action in the Neoliberal University. *ACME: An International Journal for Critical Geographies*, 14(4): 1235–1259.
- Mullings, B., Peake, L. & Parizeau, K. 2016. Cultivating an Ethic of Wellness in Geography. *The Canadian Geographer*, 60(2): 161–167.
- Smith, L.T. 2012. *Decolonizing Methodologies: Research and Indigenous Peoples*. Second edition. New York: Zed Books.

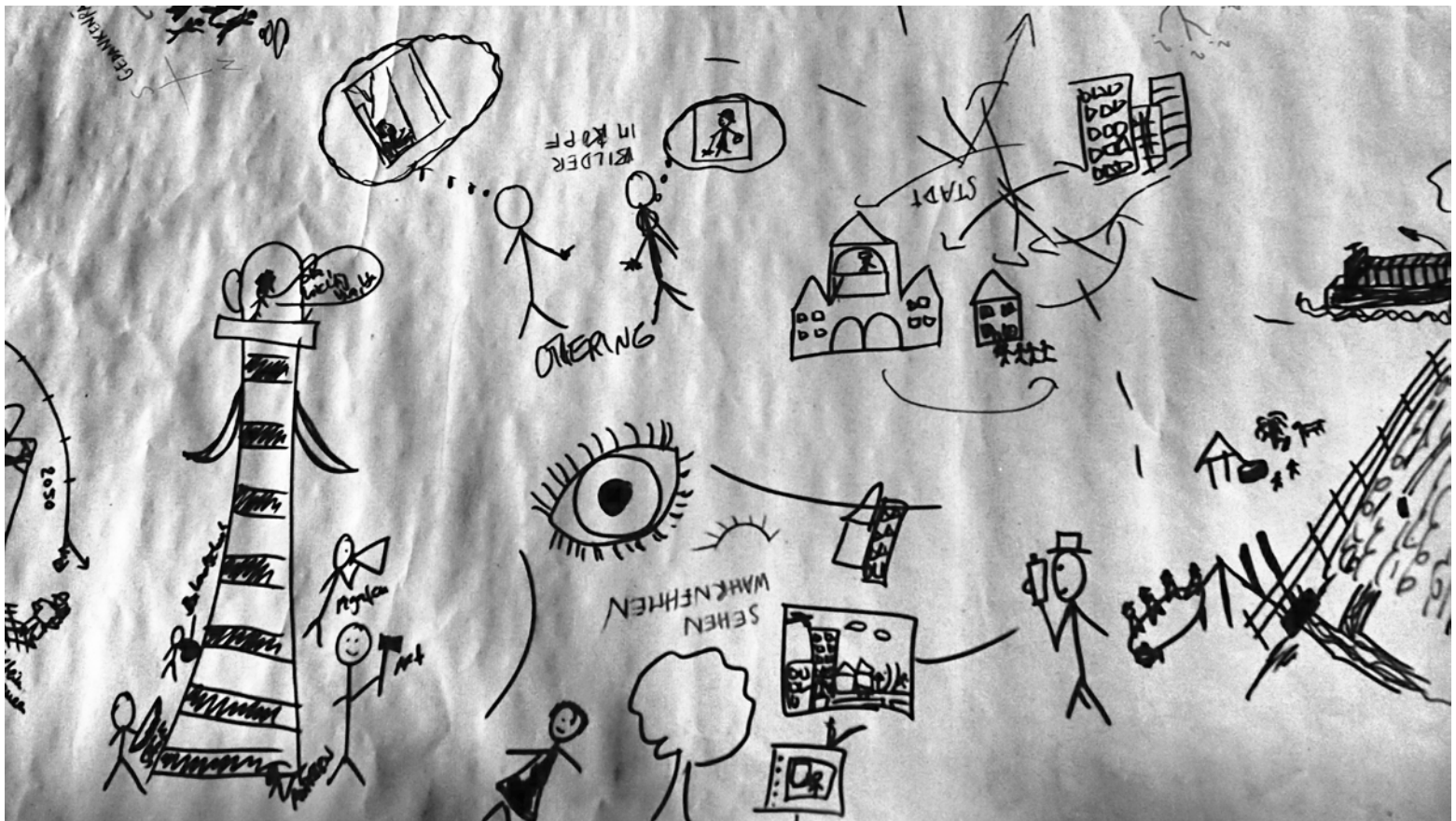
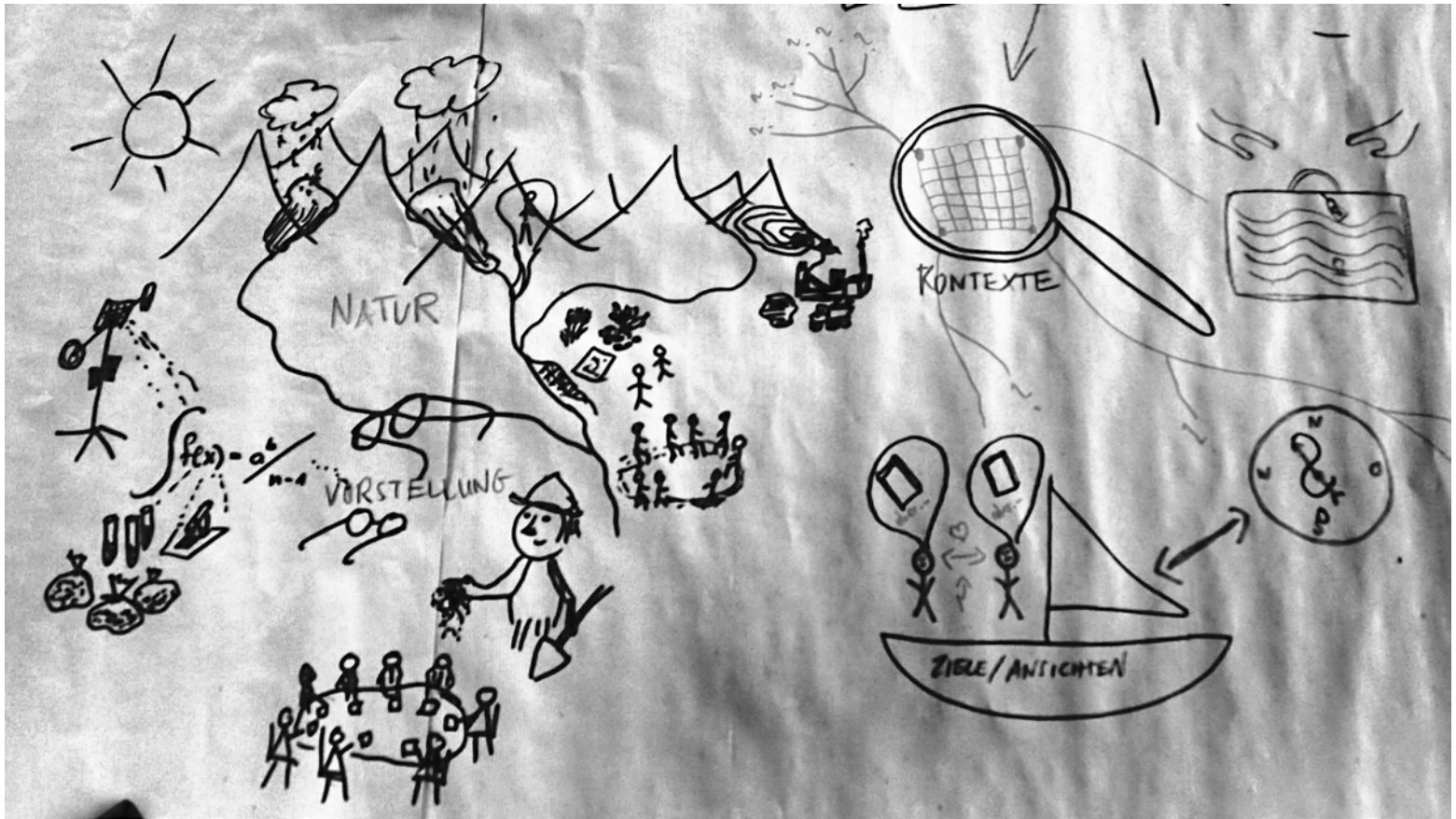





# Deep Maps

Brett Bloom  
breakdownbreakdown.net



Making a Deep Map is a way to be conscious of a place in such a manner as to hold multiple layers of understanding of the present moment in a non-reductive and robust manner. This is in contrast to the ways we normally speed through and consume the landscapes and places of our petroleum-driven, industrialized lives, and the related sense of self this produces. A Deep Map of a place includes many things: direct perceptions of that place; its inhabitants' memories; embodied understandings as the place enters you in numerous ways that are emotional, psychological, physical, spiritual and transcendental; geological formations; more-than-human actors like animals, plants, microbes and landscapes; historical developments from different eras; weather patterns; agricultural uses; modern infrastructure; bioregional processes; contradictory ideological ratiocinations and more. A Deep Mapping of a place potentially has no limits to complexity as long as it is meaningful and you have – or a group has – the ability to hold an awareness of the varying ways of understanding. The layers can be added as long as this helps elucidate and makes present a complex way of relating. This short text describes where the idea of a Deep Map comes from and how it can be developed further and applied as a methodology in direct social and spatial encounters.

The idea of a Deep Map, as an emergent method – and cultural formation – for thinking the world in terms and ways that work to eliminate petro-subjective positions,<sup>1</sup> was directly inspired by William Least Heat-Moon's book *PrairyErth: A Deep Map* (1999). In the book, he describes borrowing the ethnographers' process of "thick description." This concept was introduced by anthropologist Clifford Gertz in his book *The Interpretation of Cultures* (1973). A thick description enumerates a culture and its behaviors while it simultaneously gives a dense context so that the behavior becomes understandable to those not a part of the culture being described. Least Heat Moon's use of Deep Mapping takes on a powerful literary approach to understanding a place. *PrairyErth* tells the story of several counties in Kansas that once thrived but are now in severe decline with few denizens. Least Heat Moon creates incredibly dense contexts for telling the stories of the current inhabitants and what might motivate them to stay as things continue to decline and the world changes around them. Least Heat Moon starts each exploration of the various Kansas counties he covers in *PrairyErth* with a bevy of quotes. He takes them from historical records, daily newspapers, poems, philosophy books and many other sources from the local culture as readily as elsewhere. These quotations begin to sensitize you to the many things he will be talking about on the pages that follow immediately after. In presenting you with a particular place, he might describe important geological formations, then move on to how the indigenous people used the land, their displacement by settlers, the fast industrialization of the place, and then the decline of the modern economy, which sets the stage to meet people who have stayed in towns that are mostly vacant and falling apart. The book is a dazzling achievement that makes the stories of these places thrive and become tangible, almost a shared reality with the people he talks to.

## How to Inhabit a Deep Map

I am an artist and activist and am interested in how I can make cultural tools that help shift us out of one way of being in the world into another that is less violent and destructive, which can help us survive climate breakdown and chaos. Instead of making art that you look at, I make work that you experience directly in a cultural way, very much like you would if you went to a concert where you were asked to sing and clap along the entire time. Your presence and your expression of yourself are critical to the success of the gathering. I have 20 years of experience working as an artist in groups and making art collaboratively. This has given me a lot of experience in facilitating all kinds of group processes to amplify the subjects explored.

I use Deep Mapping as a cultural tool that can help shift our behavior and allow us to experience what it might be like to have petroleum out of our sense of self and the kinds of social formation we nurture. Least Heat Moon makes Deep Maps with writing; I have borrowed this notion to carefully craft immersive experiences to be shared and gone through with others. They have been organized and realized with the explicit purpose of practicing the de-industrialization of our individual and collective sense of self, to begin to understand what post-oil subjectivity might be. I have organized long camps and workshops where a Deep Map is created for people to enter.

Inhabiting a Deep Map is a social process, a pedagogical tool, and a way of tuning yourself to the complexities of being in any place. I work to convey a strong sense to the people who join the camps and workshops that they will be experiencing the given place we are in in a way that differs dramatically from petroleum-based space and time, which flattens places and our experiences of them.

In the summer of 2015, I co-organized a camp in rural Scotland that focused on the dramatic landscape that surrounded the Scottish Sculpture Workshop (SSW), the venue that hosted the gathering. This landscape is heavily industrialized yet maintains a beauty and mystery that gives one a sense that it could be restored and understood in radically other ways. The camp lasted 11 days. Around 30 people attended. We engaged where we were with directly embodied learning processes. We used exercises that come from a variety of sources. One source that is used frequently is Deep Listening. It is a practice developed by the American composer and electronic music pioneer, Pauline Oliveros, to train ourselves to use our vast perceptual capacities to sense sounds, energy flows, and ancient rhythms in ourselves and the world. A simple beginner's exercise – that has many similarities to meditation, but is directed towards the outside world and not one's inner peace – is to sit and listen for 30 minutes to all the sounds one hears moving from the global (hearing everything at once) to the focal (listening to a specific sound until it stops). The results are always quite surprising. Thirty people listening all to the same sonic environment in this way will each come up with very different understandings of what it is they heard. It becomes immediately clear that the wildness of existence is just on the other side of a very permeable threshold!

We combined these exercises with discussions about climate breakdown and our fears about the future. We read and discussed texts that sensitized us to various issues like animistic knowledge and how to regain the powerful tools of sensing the world that we



have evolved with but suppress with regular calls to being rational about everything. We had guests come and talk about a variety of subjects that included land reform, soil and spirituality, re-inhabiting rural Scotland via the tradition of hutting, and more. We had workshops where we walked, with ecologist Nance Klehm, around the small town where SSW is located and learned empathic tools for understanding plants and their characters in addition to the medicinal properties of these plants that were growing in the cracks of sidewalks and in alley ways. Another workshop, led by soil scientist Bruce Ball, had us looking at soil samples everyone was asked to bring from their homes so we could understand how the soil worked and how to gauge its relative health. We made excursions to a nearby permacultural farm. We took a longer trip to an enormous rewilding initiative on 10,000 hectares by an organization rewilding the Scottish landscape – Trees For Life is restoring the Caledonian forest on a former estate where overgrazing and hunting for many generations had destroyed much of what had been there.

We had a sauna made so people could relax after the long 12-hour days of activities (see image on opposite page). The interior was made from locally harvested larch, and the rocks that sat on the wood-burning stove came from streams, fields and the hills surrounding SSW. The exterior was made from old whiskey barrels and had an amazing smell every time it rained. The sauna was used by artist Mari Keski-Korsu to do whisking and heat balancing for those who wanted it. This is an ancient Baltic healing tradition that she is trained in. Keski-Korsu made whisks from various trees that were in the hills surrounding SSW. A typical session went like this: You would sit in the sauna with Mari for 30 minutes, exit and cool down a bit, then reenter after she rinsed you with birch water. You would lie naked and face down on a pillow of aromatic leaves. Mari would then whisk your body, swirl heat from the top of the sauna down over your body and then massage parts of your body with the tree branches. Next you would turn over. A hot bunch of leaves put on your genitals. More clumps of hot aromatic leaves put over your face. And even more put under your arm pits as Mari continued to move the hot air over your body, beat the soles of your feet, and literally melt your consciousness into a completely other place. Keski-Korsu also introduced the group to animal communication via a workshop with Clydesdale horses, which were used for centuries to work the landscape.

After many days of being constantly immersed in these kinds of experiences, a relatively strong group cohesion emerged for most people as did an alternate sense of place and time. This was not just my own perception but something that was communicated to me directly or in passing when I overheard others making statements that revealed this, particularly about their shifted sense of time. This has been an organic part of all the Deep Map situations I have organized. Each group arrives at this state at a different moment, but they do get there and the Deep Map is an important part of this.

### Extending Deep Mapping

Permacultural resource mapping, developed by the late Bill Mollison and others, can be used to help visualize aspects of a Deep Map. These processes are highly compatible and are very powerful when combined. I am constantly inspired by illustrations from the *Permaculture: A Designers' Manual*, by Bill Mollison (1988), in particular two maps that show the production of a single chicken egg. One shows an industrial egg and all the resources that go into making it, complete with all the energy-intensive and wasteful processes like the burning of fossil fuels to make many of the materials needed to house, feed and transport eggs laid by the chickens. This map is contrasted with another that shows a permacultural egg and how its making dramatically reduces the wasteful and polluting energy inputs needed by creating things like self-generating food sources that feed the chicken as the chicken's waste feeds it, and so on.

The image above demonstrates how I have used permacultural resource mapping. Material like this map is used in the gatherings I organize. This particular map is of an individual's Petro-Subjectivity; it presents many potential intersections in one's life with oil and its presence in every imaginable process and action. Making maps like these are useful to help think about how you would go about organizing your own Deep Map experience.

### Instructions for Making a Deep Map

Making a Deep Map takes a significant amount of time to organize and construct. It requires a commitment of resources, finding collaborators and creating a situation where one is a facilitator among other facilitators. Everyone involved in some way becomes a co-creator of meaning and experience. The Deep Map enables an experience where no one person, discourse, or narrative holds power over an understanding of the things you are investigating. They are combined, piled up and co-exist even when they seem to be contradictory. The Deep Map gives participants immediate, directly embodied participation in the subjects and leaves them with an understanding that is not possible otherwise.

1. Start by organizing an extended, immersive gathering – like a camp<sup>2</sup> – where there is a lot of time to explore a specific set of concerns from multiple perspectives. The gathering can be for a 3-day weekend or much longer. This can happen in a city and is an option which deserves experimenting with. However, a rural location makes for greater group cohesion



and concentration as people will be taken away from the stresses and demands of their urban lives.<sup>3</sup>

2. Explore topics in several different, overlapping, layered ways. Make space for people who use multiple, and contradictory, kinds of "languages" for understanding the world, for example: academic, activist, spiritual, myth-telling, empathic, visionary, scientific or any combination of these.
3. Explore topics through multiple kinds of activities: lectures, directly embodied learning, walks, discussions, readings, hands-on workshops, team-building exercises, interspecies communication and more to address your set of concerns.
4. Have your activities unfold in a variety of settings. You can have multiple discussions, for example, but try different social formations to do this: formal presentations in a circle, a loose gathering around a bonfire at night with food and drinks, on top of a high-rise building, a moderated discussion on spectrum,<sup>4</sup> plus many more ways.
5. Take care to provide a thoughtful blend of variation and repetition. It is good to have too much happening, so there is this feeling of being overwhelmed, but make sure it is in a positive way. Give people the freedom and feeling that they can opt out of things if they become overwhelmed. Reassure them that there is no judgement if they need to take a break and take care of themselves.
6. Take excursions to visit people, initiatives, landscapes or anything else that offers yet another perspective or way of considering what it is you are exploring. This puts people into an additional dynamic situation that you have not organized but that will only amplify your other activities.
7. Figure out the economics of the Deep Map gathering. This is relative to the ambition and scale of what you want to organize. Deep Maps can work with grants where people have only to pay for a little bit of the gathering, or maybe you have to ask people to cover all the costs of transportation, food, speaker fees, workshops, etc. Keep it affordable for participants if you can.
8. Decide who you want to invite to your Deep Map. This will effect what you organize and the kind of experience you have. You can have an open call and accept anyone who answers the fastest. You can have folks answer questions that show their level of engagement with the subjects you are exploring and then make a curated selection. Perhaps you develop a different strategy to bring people in, but it is good to give this aspect of organizing a Deep Map enough consideration.
9. Make Deep Map guidelines.<sup>5</sup> They can be as minimal or as detailed as your gathering requires, but should be used to help strengthen and support the success of the Deep Map.



#### Endnotes

1. Petro-subjectivity is something that each of us experiences constantly. It is a sense of self and the world that shapes who we are and how we think. It stems in part from the fact that the use of oil is present in everything we do. It has shaped the concepts that govern our thinking. Our use of language and the basic concepts that structure our existence are breathed through the logic of oil relationships and form the metaphoric universe we bathe ourselves in when we speak to one another about who we are, what we do and what the world around us consists of. From *Petro-Subjectivity: De-Industrializing Our Sense of Self*, by Brett Bloom, Breakdown Break Down Press, 2015.
2. A great resource for understanding the history and forms of camps and their potentials for being used in a variety of capacities, for making Deep Maps and other things, is Charlie Hailey's *Camps: A Guide to 21st-Century Space*, MIT Press, 2009.
3. Commuting restraints were so severe in London that it cut a lot of time off of when we could start and end our days together: In Helsinki, people were distracted by the proximity to their "urban busyness" – the fear that they might be missing out on something else – and it effected the cohesion of the group.
4. This is a specific kind of discussion used by activists to visualize the various positions people represent in a debate. In the space where you are holding your discussion, you designate two extreme positions in a debate and give them a physical location, perhaps by marking the spaces with chairs. You ask people participating to locate themselves at or between these two points. The discussion is facilitated and draws out the differences as a way to discuss the issues.
5. An example of Deep Map (Camp) Guidelines:
  - This is a place of respect for differences in race, ethnicity, gender, sexuality, religion, ideology, temperament, pace, ability, introversion and extroversion.
  - We practice discourse diversity, in the sense of biodiversity, and the necessarily complex set of experiences, cultures, education, and so on that shape each of us.
  - We have respect and awareness for the non-human participants in the camp at the site and anywhere we may go.
  - We work together to make this a safe space for you and for anyone at the camp. It is important to take care of yourself, to make sure you are healthy, and that you are not stressed out by anything at the camp. Take time away if you need to from group situations and processes. Ask for help should you need it.
  - This is a place for constructive, generous criticism, reflection, and pushing each other to learn and understand in an intense yet nurturing manner.

#### References

- Bloom, B.A. 2015. *Petro-Subjectivity: De-Industrializing Our Sense of Self*. academia.edu/18494906/Petro-Subjectivity\_De-Industrializing\_Our\_Sense\_of\_Self, 14 January 2018.
- Hailey, C. 2009. *Camps: A Guide to 21st-Century Space*. Cambridge, Mass: MIT Press.

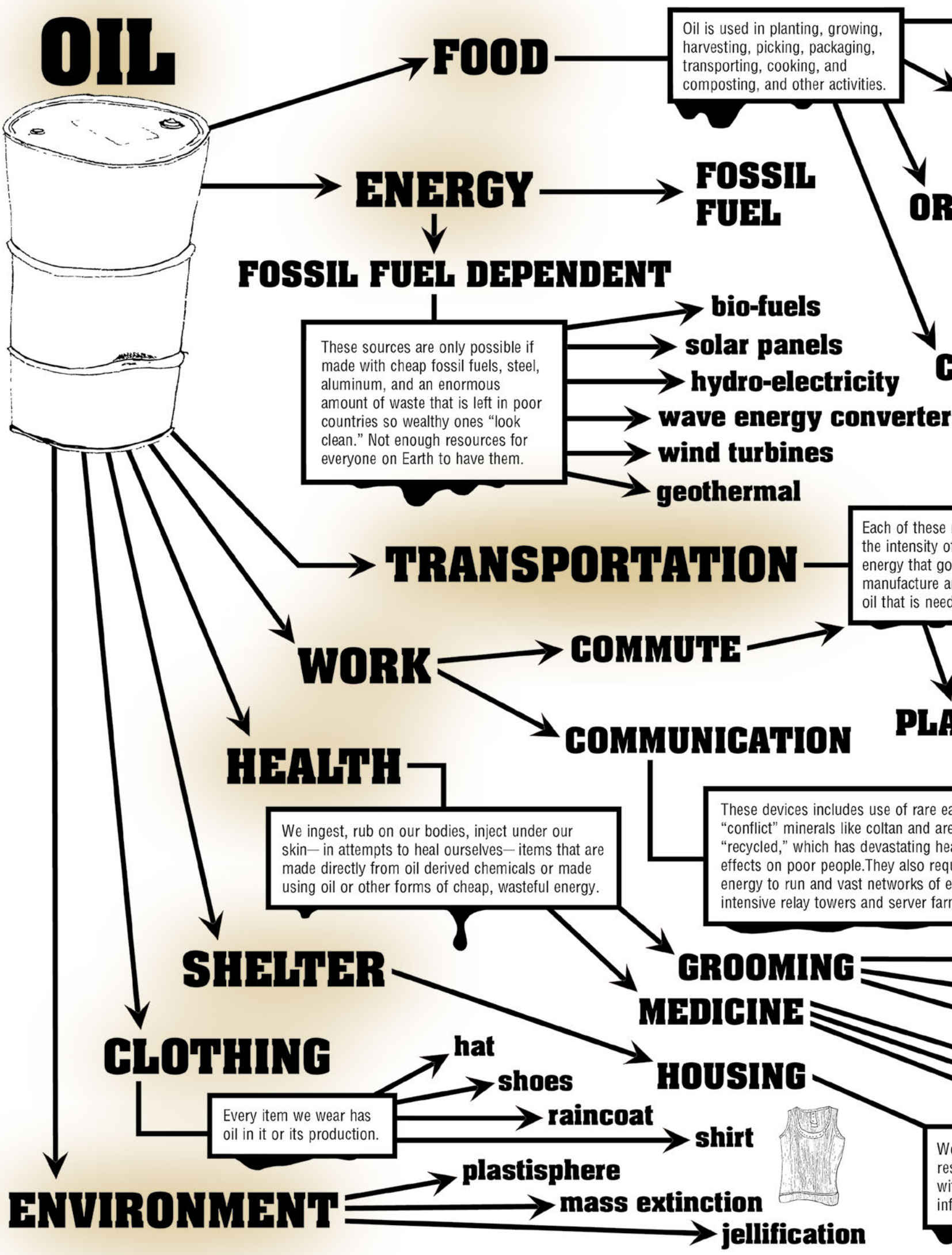

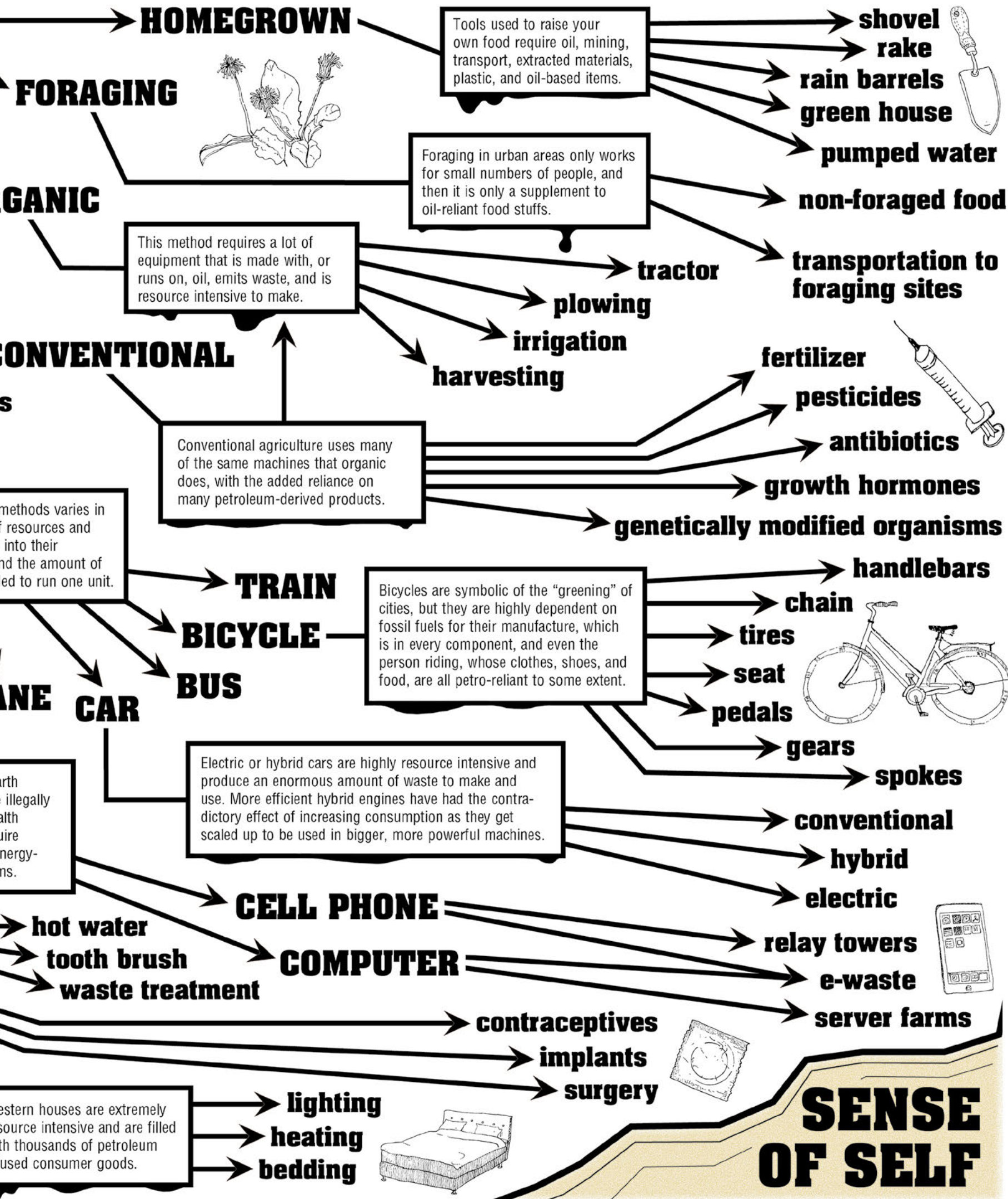



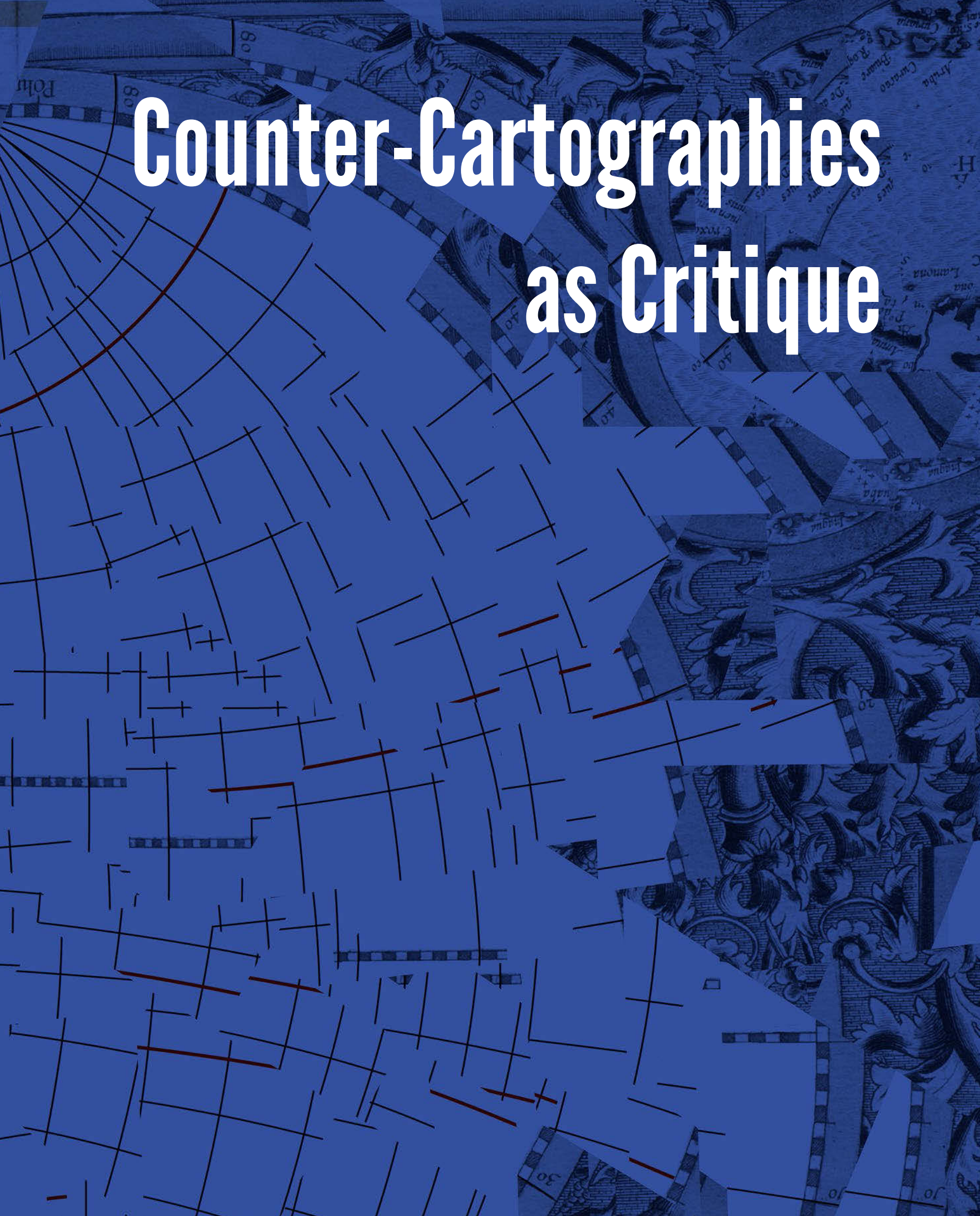

# Counter-Cartographies as Critique

# Uneven Digital Geographies

... and Why They Matter

Mark Graham, Stefano De Sabbata, Ralph Straumann, Sanna Ojanperä

geonet.oii.ox.ac.uk

by Mark Graham (@geoplace)  
and Stefano De Sabbata (@maps4thought)  
Internet Geographies at the Oxford Internet Institute  
2013 • geography.oii.ox.ac.uk

data source:  
Times Higher Education  
timeshighereducation.co.uk

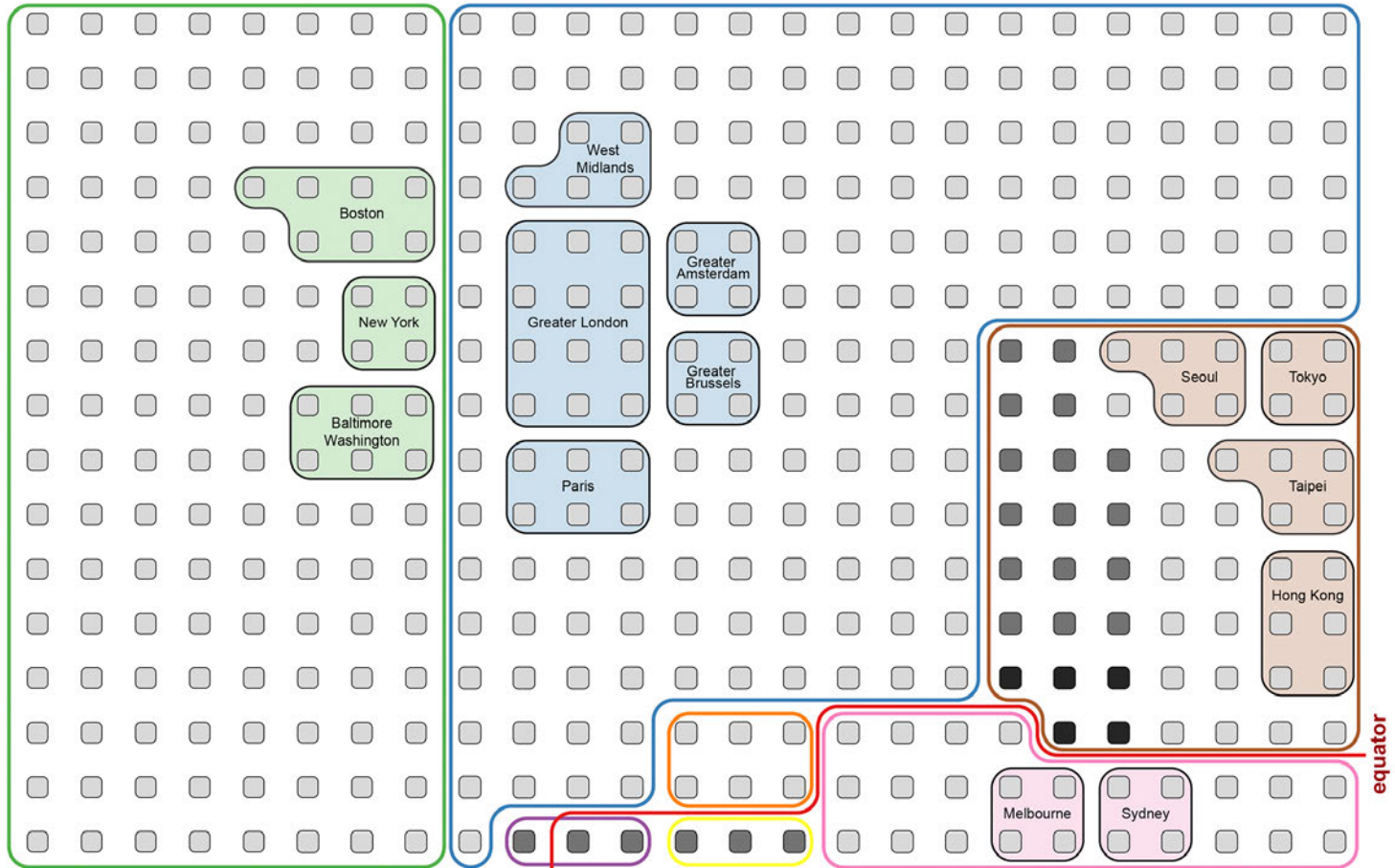

## Top 400 Universities according to Times Higher Education 2013-2014

- North America
  - Latin America & Caribbean
  - Europe
  - Middle East & North Africa
  - Sub-Saharan Africa
  - Asia
  - Oceania
- High-income
  - Upper-middle-income
  - Lower-middle-income
- Country economy classification according to the World Bank 2013 data.worldbank.org/about/country-classifications

Information has always been spatial. It is produced somewhere; it is used somewhere; it moves between places (Graham et al., 2015a). And the geographies of information have always been imbricated in power relationships. Some people have far more control over it than others, and some places are central in information ecosystems whilst others are peripheral.

For instance, the map Top 400 Universities (see opposite page) shows the locations of the world's top 400 universities as ranked by the Times Higher Education. It also illustrates the relative wealth of the country that hosts each university. There are no universities from low-income countries present on the list, and India is also the only lower-middle income country represented, being home to five of the world's top-400 ranked universities. Most of the world's elite universities are in the Global North, most of the world's published academic knowledge is produced in the Global North, and even acceptance rates for most journals tend to be higher for authors from the Global North. Amazingly, the Greater London cluster alone contains the same number of top-400 universities as all of Sub-Saharan Africa, the Middle East and Latin America combined! We have a state of affairs where the Global North has tended to be a producer of knowledge and the Global South has tended to be a consumer of it.

Relatedly, the maps Submission by Country... and Acceptance Rate by Country ... (Graham, 2015) were created from some submission data that SAGE journals shared with us. Amongst other things, the data tell us where authors of articles come from and the primary discipline of the journal they are submitting to.

We see much more academic content coming from the Global North than from the Global South. Africa in particular is notable for its absence. Most countries on the continent fail to register even a single journal article submission. Not only do a lot of countries in the South have a particularly low number of submissions, they also have very low acceptance rates for the small numbers of submissions that they do have, further deepening the geographic divides in knowledge production.

However, many have pointed to the internet as a way of transcending some of these traditional constraints. Access to the internet, in theory, allows users to access the sum of all codified human knowledge; it allows people to participate in a more level playing field. This is because there are relatively few geographic barriers to the information flow over the internet. With a few exceptions (notably China and a few other authoritarian regimes), content like a Wikipedia page or Google Book is equally accessible to anyone on Earth.

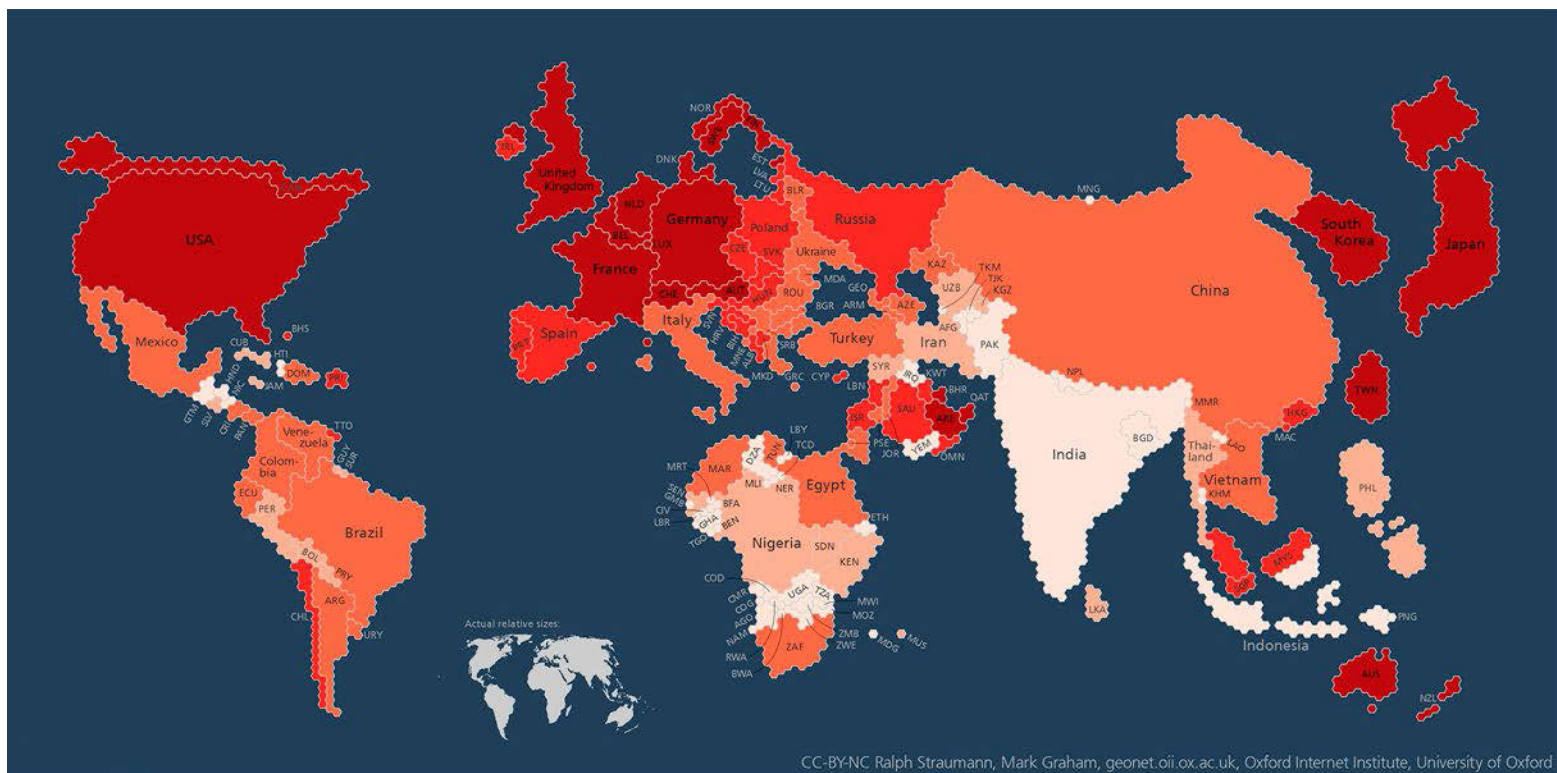

## The World Online

### Percentage of people online

80–100% 60–80% 40–60% 20–40% 0–20%

### Number of people online

One ● represents roughly 470,000 people online.

The countries are scaled proportionally to the number of Internet users in that country. Countries with fewer than 470,000 people online have been removed from the map. The shading indicates the percentage of the population that is online.

The visualization uses 2013 data from the World Bank's Worldwide Development Indicators project and from Natural Earth.

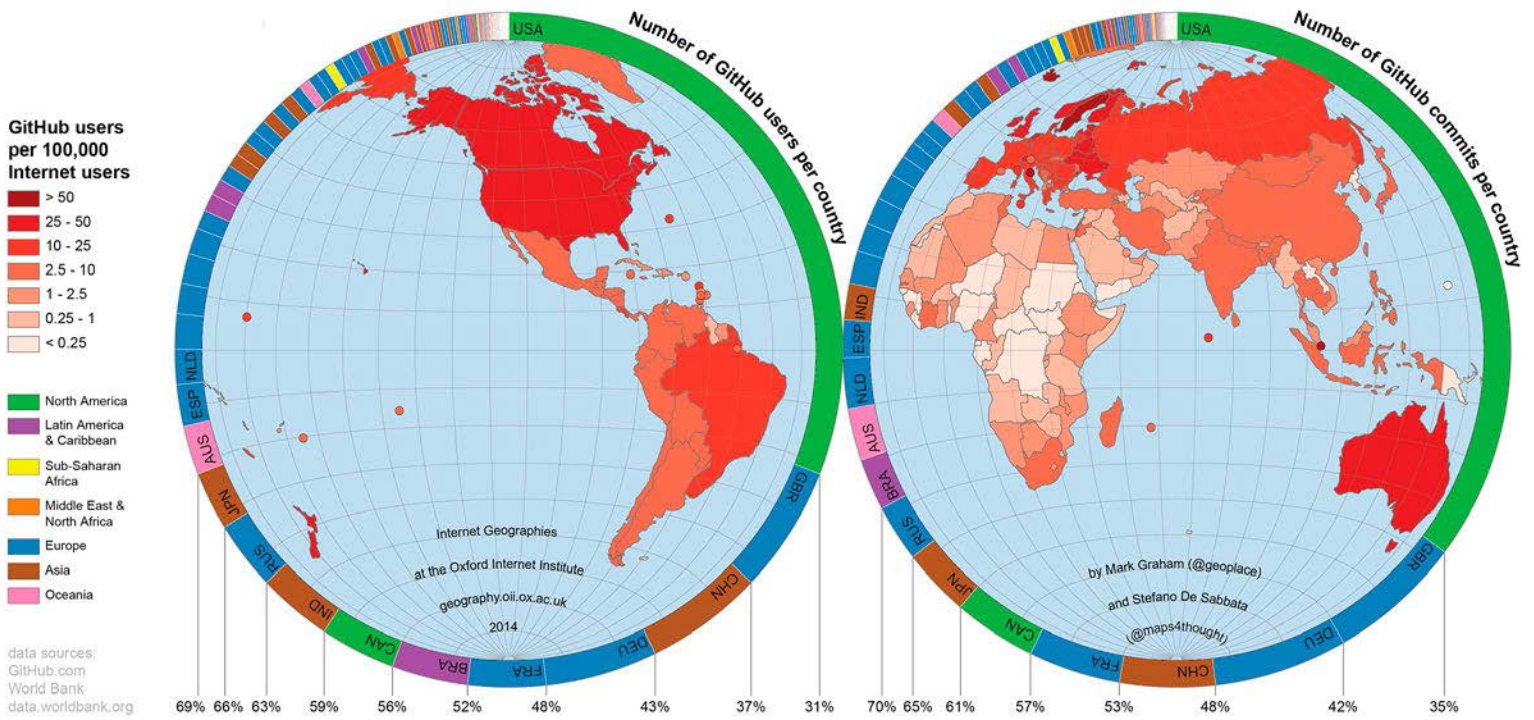

# GitHub | Mapping collaborative software

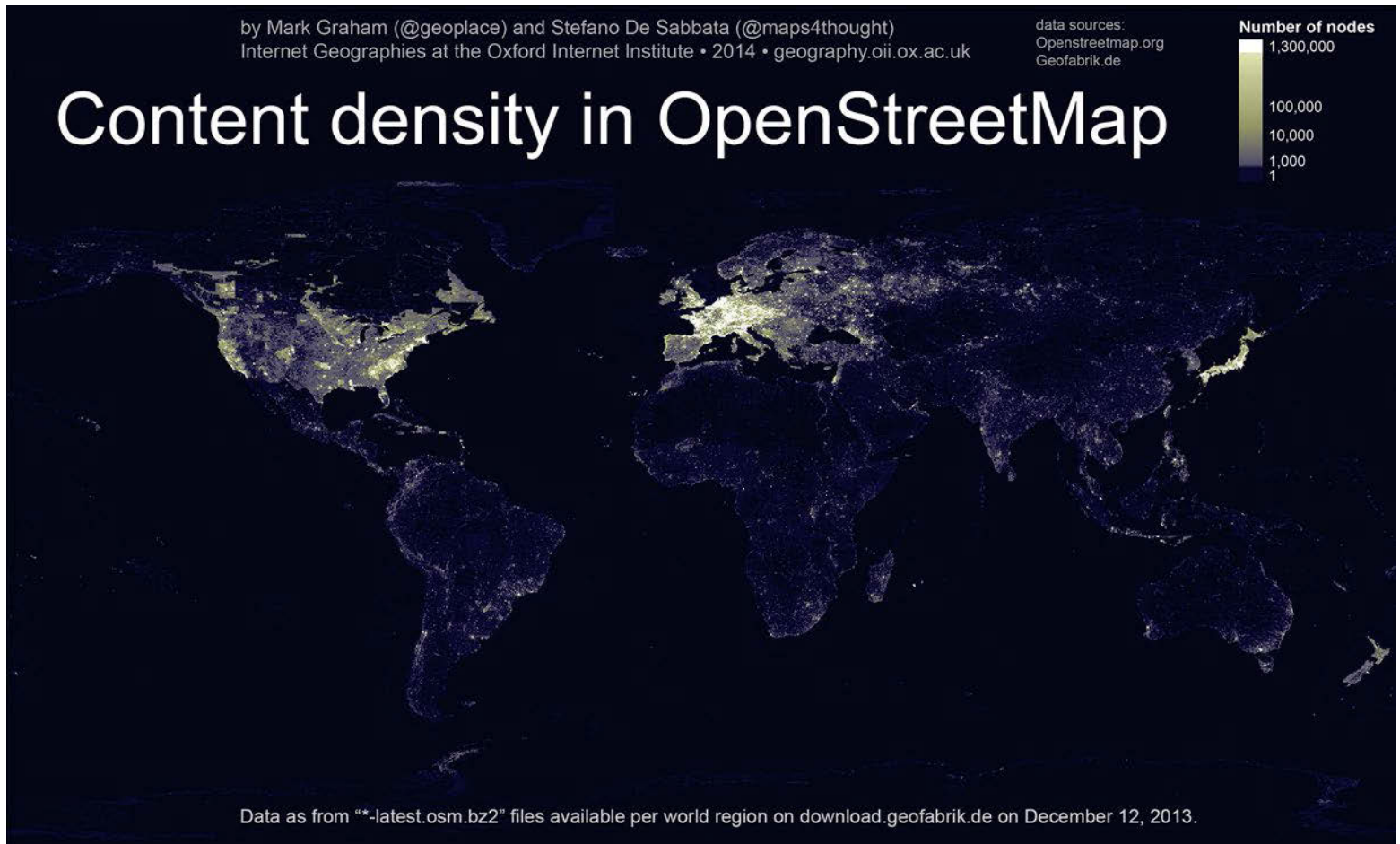



But it is worth remembering that the internet, and information within it, is also characterised by real geographic inequalities. A majority of humanity has still never used the internet, and some parts of the world have very little representation in our digital world.

But, even with those imbalances in mind, it is worth remembering that there are about four billion internet users in the world. All of those people can potentially contribute to the wealth of information that we all share and use on the internet. The problem is that they don't.

## Digital Participation

We can look at one of the world's biggest and best-known hosting services for software development projects, for instance: GitHub. The shading of the map *GitHub | Mapping collaborative Software* (see opposite page top) illustrates the number of GitHub users as a proportion of each country's internet population. The circular charts surrounding the two hemispheres depict the total number of GitHub users (left) and commits (right) per country.

North America and Europe each account for about one third of the total number of GitHub users. The Middle East, North Africa, and Sub-Saharan Africa together represent less than 1% of GitHub users, and just about 1% of commits. Switzerland alone counts almost as many GitHub users as the Middle East and North Africa region, and more than Sub-Saharan Africa. The geography of digital engagement in this facet of the "knowledge economy" is thus starkly uneven.

Wikipedia is another useful example of a platform that in theory allows anyone in the world to submit information to it. In practice, though, we also see massive inequalities in the amount of content submitted to Wikipedia from different parts of the world. The vast majority of Wikipedia is written by people in the Global North, and only a tiny amount of content comes from people in the South (see Graham et al., 2016, for more on the topic). This matters because editors from the North can easily overpower editors from the South when writing about contested topics.

The Middle East is perhaps the part of the world where we see these divides most starkly manifested. There are almost as many edits that come from Israel as from the entire rest of the region combined: from Morocco in the West to Iran in the East (Graham, 2012). Thus people in just a few parts of the world seem to have much more voice than everyone else (see Ojanperä et al., 2017 for more on this topic).

## Digital Representation

Not only are some parts of the world left out of practices of digital participation, some parts of the world are also covered by much thinner augmentations of information than others. These layers of information help to comprise and define a place: It is thus important to understand not just where they come from but also where they represent.

The map *Content Density in OpenStreetMap* (see opposite page bottom) shows the location of edited content in the world's largest collaborative mapping project: OpenStreetMap. In OpenStreetMap, high-income OECD countries are home to about 80% of the submitted content. We thus end up with comparisons like the fact that Egypt accounts for as many nodes as Iceland, despite being 10 times as big and being home to 250 times the population.

We can see similar uneven geographies of digital representation if we look at GeoNames (see following page), which is the world's largest freely available gazetteer (i.e., a dictionary of geographic place names). The pixel colours represent the number of names referring to a geographic place per spatial unit: a square of a one tenth degree of latitude and one tenth degree of longitude (see Graham & De Sabbata, 2015 for more on the method).

The US accounts for slightly more than a quarter of the database. There is actually more content created about the US than all of Asia combined (Asia accounts for only about 23% of geographic content, despite being home to over half the world's population). Interestingly, the information presences that we see are characterized by unusual patterns. Not only do we see the usual suspects of Western Europe and the United States with large amounts of geographic information, but we also see significant densities in places like Sri Lanka, Iran, and Nepal. By defining structured geographic information about the world, gazetteers ultimately have the power to shape and structure how geographic meaning is made. The presences and absences of data within shape how the world is digitally re-made.

Finally, it is worth exploring the geography of content in Wikipedia. The map *The Geographical Uneven Coverage of Wikipedia*, presented on the double page, points out the highly uneven spatial distribution of (geotagged) Wikipedia articles in 44 language versions of the encyclopaedia. Slightly more than half of the global total of 3,336,473 articles are about places, events and people inside the red circle on the map, occupying only about 2.5% of the world's land area (see Graham et al., 2014, for more on this research). Much like GeoNames or OpenStreetMap, Wikipedia plays an important role in shaping how we understand the world. The geography of content within it, therefore matters immensely.

## Placenames per square kilometre in GeoNames

(Percentiles)

- >0.24 (>90)
- 0.11 - 0.24 (75 - 90)
- 0.04 - 0.11 (50 - 75)
- 0.01 - 0.04 (25 - 50)
- ≤0.01 (<25)

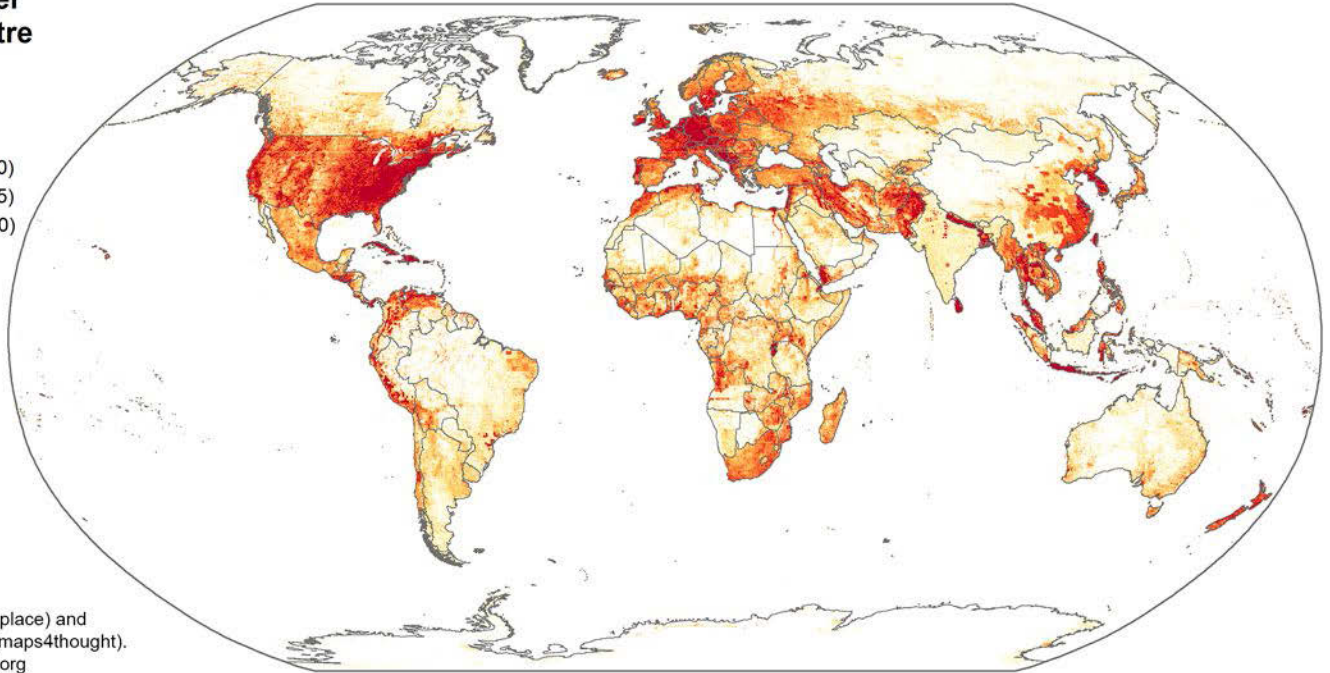

by Mark Graham (@geoplace) and  
Stefano De Sabbata (@maps4thought).  
data source: geonames.org

## Information Geographies and the Geographies of Information

It is worth remembering that the geography of information production has always been characterised by significant geographic biases. But the fact that billions of people are now connected to the internet was seen by many as a moment of change. The internet has been described as a "leveller" and a "democratiser" (c.f. Graham et al., 2015) – allowing anyone to access what Wikipedia refers to as "the sum of all human knowledge"; allowing anyone to contribute. If users in Manchester, Mombasa, and Mumbai are connected, there should be no difference in their propensity to access and create digital knowledge, right?

In practice, we see a very different world from that vision. A world in which some places are far more visible than others. A world in which people in some parts of the world have a much bigger say in how our digital environments are constructed (see also Graham, 2015b).

Let's remember that the places we live in are increasingly digital. Our cities are no longer just made of bricks, mortar, glass and steel. They are also made of data (Graham, 2013; Graham et al., 2013).

As such, it will continue to be hugely important to interrogate the digital layers of places. Where are they? What are they? What do and don'ts, they exclude? Who constructs them and who is sidelined? And who controls them (Shaw & Graham, 2017)? These are the questions that we need to be asking if we ultimately want to work towards less uneven and more just information geographies.

## References

- Graham, M. 2012. Mapping Edits to Wikipedia from the Middle East and North Africa. [markgraham.space/blog/mapping-edits-to-wikipedia-from-the-middle-east](http://markgraham.space/blog/mapping-edits-to-wikipedia-from-the-middle-east), 13 January 2018.
- Graham, M. 2013. Geography/Internet: Ethereal Alternate Dimensions of Cyberspace or Grounded Augmented Realities? *The Geographical Journal*, 178(2): 177–182.
- Graham, M., Hogan, B., Straumann, R.K. & Medhat, A. 2014. Uneven Geographies of User-Generated Information: Patterns of Increasing Informational Poverty. *Annals of the Association of American Geographers*, 104(4): 746–764.
- Graham, M., Zook, M. & Boulton, A. 2013. Augmented Reality in Urban Places: Contested Content and the Duplicity of Code. *Transactions of the Institute of British Geographers*, 38(3): 464–479.
- Graham, M. 2015a. The Geography of Academic Knowledge. [geonet.oii.ox.ac.uk/blog/the-geography-of-academic-knowledge](http://geonet.oii.ox.ac.uk/blog/the-geography-of-academic-knowledge), 13 January 2018.
- Graham, M. 2015b. Information Geographies and Geographies of Information. *New Geographies*, 7: 159–166.
- Graham, M. & De Sabbata, S. 2015. Mapping Information Wealth and Poverty: The Geography of Gazetteers. *Environment and Planning A: Economy and Space*, 47(6): 1254–1264.
- Graham, M., Andersen, C. & Mann, L. 2015. Geographical Imagination and Technological Connectivity in East Africa. *Transactions of the Institute of British Geographers*, 40(3): 334–349.
- Graham, M., De Sabbata, S. & Zook, M.A. 2015. Towards a Study of Information Geographies: (Im)Mutable Augmentations and a Mapping of the Geographies of Information. *Geo: Geography and Environment*, 2(1): 88–105.
- Graham, M., Straumann, R.K. & Hogan, B. 2016. Digital Divisions of Labor and Informational Magnetism: Mapping Participation in Wikipedia. *Annals of the Association of American Geographers*, 105(6): 1158–1178.
- Ojanperä, S., Graham, M., Straumann, R.K., De Sabbata, S. & Zook, M. 2017. Engagement in the Knowledge Economy: Regional Patterns of Content Creation with a Focus on Sub-Saharan Africa. *Information Technologies & International Development*, 13: 33–51.
- Shaw, J. & Graham, M. 2017. An Informational Right to the City? Code, Content, Control, and the Urbanization of Information. *Antipode*, 49(4): 907–927.



# The Geographically Uneven

While it is an invaluable resource of knowledge for geographic distribution. Below map is based on 3,44 language versions. Each article is represented by

oiiioiiioii Oxford Internet Institute  
oiiioiiioii University of Oxford  
oiiioiiioii



There are **more** Wikipedia articles **inside** this circle **than outside** of it

This map project a

# Geographic Coverage of Wikipedia

For numerous users, Wikipedia's articles have a strong bias in their geographic coverage. This visualization shows the geographic coverage of 336,473 geotagged articles in November 2012 data dumps of Wikipedia, with each article represented by an orange dot.



This visualization is part of the Information Geographies project, available at <http://geography.oii.ox.ac.uk>.

CC-BY-NC  
Ralph Straumann, Mark Graham  
Data sources: Wikipedia, Natural Earth

# From Data Commons to (Critical) Cartography

## Linking Data Sources for a Gender Street Map of Vienna

Florian Ledermann

genderatlas.at

### Female Mayors in Austria

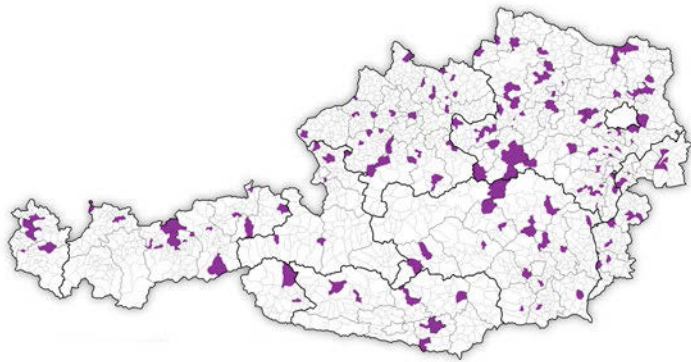

### Street Names in Vienna



### Pioneers



### Commuters in Burgenland

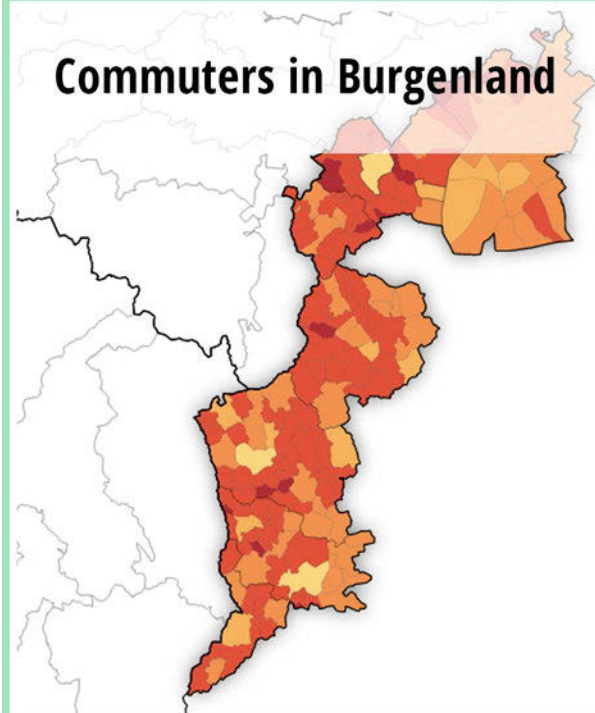

Creating a map can be an effective strategy to challenge established representations of reality. However, for many critical cartography projects, initial ideas of what should be made visible on the map are quickly followed by the sobering insight that suitable data is often simply not available. Even when we would be willing to pay for the data or work with commercial or governmental institutions to get access to data, we may find the specific market-driven or governance-centered view of these actors shapes the data that is collected and released in the first place and therefore available for map-making projects.

For the genderATlas project, we faced the challenge that while a lot of statistical data on various aspects of the representation and opportunities for women is collected by official statistical bodies, the granularity of those data is usually limited to the level of administrative units, such as counties and municipalities, restricting any cartographic project using the data to reproducing this predominant way of structuring space according to the established hierarchy of political administration. For any more fine-grained analysis, such as the reflection of the representation of women in public space on an urban scale, we would be on our own – extensive spatial data sets on the issue of gender equality are simply not available on a fine-grained scale in Austria.

To allow us to produce a map for the topic of gender representation in urban public space, we developed an approach of working with data commons that are not by themselves concerned with the topic (like Wikipedia or OpenStreetMap), but allow us to link those sources together and build upon them. In the process, we would contribute to the commons in the form of corrections and additions, as identified by the needs of our project. By "standing on the shoulders of giants", we could leverage the precision and extensiveness of these community-driven initiatives to support our critical mapping project.

## Data Scraping

As of January 2016, Vienna has 6,842 streets and squares. The topic of fair representation of women in street names is well known and publically debated in Vienna, but no comprehensive publically available data source exists that would allow detailed analysis or visualization. Also in the realm of data commons, a data set with the required information was not available.

Wikipedia provides a comprehensive list of street names for Vienna, separated by district, which is well maintained and includes a short comment on the origin of the name.<sup>1</sup> These comments include the name of the person the street is named after, but not their gender in an explicit format. In a first step, we constructed a computer-processable list of street names and their "base names" (the entity the street is named after) by scraping the data from Wikipedia, using a Python script. Errors that occurred during the data scraping (e.g. due to inconsistent formatting of the list) were fixed directly in Wikipedia, thereby contributing to an improved data common.

## The (False) Promise of Total Automation

The second data commons we used was a free list of first names and their gender assignment.<sup>2</sup> An initial attempt to assign gender information to the base names automatically through a script by simply looking up the first word (assumed first name) on the list of names failed – only about 19% of streets were assigned a base name that could be linked to a specific gender (15.1% male and 3.6% female). However, this process gave us a starting point for subsequent manual processing.

In this manual data processing step, all street names, the automatically assigned gender information and the comments from Wikipedia were exported to a spreadsheet and edited manually. This took approximately two full working days and resulted in a reliable source of information for the analysis. It showed that 57.4% of the streets were named after a male person and only 5.2% after a female person (a factor of 1:11). Interestingly, the automatic assignment step worked considerably better for female names (3.6% vs. 5.2% correctly assigned) while it worked for only a fourth of the male names (15.1% vs. 57.4%)! The reason for this difference lies in the fact that for female persons, the first name of the person is more often added to the street name (e.g. Maria-Theresien-Straße), while for male persons, only the family name is often used, making it impossible to detect the gender with our automatic approach.

Computer technology often suggests that everything can be automated and manual labor or interpretation becomes obsolete. Our project shows that this is a false promise – although all information was available, extensive human processing was required to complete the process and verify the correctness of the data. The automatic processing even skewed the results to grossly overestimate female representation, which illustrates the fact that even "neutral" technical algorithms can and will amplify subtle discriminatory aspects of social reality if applied without critical supervision and the possibility for human intervention.<sup>3</sup>

### **Classification Ambiguities**

Even if a manual processing step is performed, a seemingly simple task, like assigning a gender to historical names, is not free of ambiguities. Some streets in Vienna are named after historical persons (Maria-Theresien-Straße), others after fictitious or religious characters (Mariengasse), yet others may be named after places that are in turn named after real or historical persons (Mariahilferstraße). We decided to include only streets named after historical persons in our categorization in order to reflect the social acknowledgement of real people in public space and to omit fictitious characters and derived toponyms from the gender categories.<sup>4</sup>

### **Producing the Map with OpenStreetMap data**

In a last step, the annotated street name data was joined with geometry data from OpenStreetMap (OSM)<sup>5</sup>. Geometry from OSM was selected and downloaded, using the Overpass API<sup>6</sup>. The final online map was produced with the help of the mapmap.js cartographic library<sup>7</sup> to create an interactive visualization of the data from the analysis. Viewers of the map can switch between a street map, revealing details like short biographical sketches of the historical persons, and a diagram view, where all streets are lined up in three categories (female, male, other) by their length.

### **Response**

Although the facts we showed on our map were well-known before and are subject of an ongoing debate in the city, the map got a very positive reception and is, at the time of writing, the second-most accessed map in the genderAtlas. We suspect that some of the popularity is also owed to the unconventional animation, showing the powerful but somewhat ambiguous role that "special effects" have, even for spreading critical messages.

However, like any counter-hegemonial project with high visibility, the map also attracted trolling and criticism, with some critics focusing on the classification ambiguities discussed above. It was important to have a clear policy on how to deal with these ambiguities within the project in order to respond to such criticism (which, however, often seemed to be not intended as constructive feedback anyway but purely to find flaws in a project opposed on political grounds); in a next version of the map, we are planning to communicate these decisions even more explicitly and consider providing a user interface for letting the viewers decide on the classification policy, for example, on whether or not to include toponyms in the categorization.

The attempts of individuals to discredit the project based on perceived errors shows, however, that accuracy of the data and a clear documentation of how ambiguities and edge cases are dealt with is of special importance for counter-hegemonial and critical projects, even for seemingly simple and straightforward projects, like visualizing the representation of gender in the street names of a city. The resulting map and data is available at [genderatlas.at/articles/strassennamen.html](http://genderatlas.at/articles/strassennamen.html)



## Endnotes

1. List of street names in Vienna by district / Wikipedia  
[de.wikipedia.org/wiki/Liste\\_der\\_Straßennamen\\_von\\_Wien](https://de.wikipedia.org/wiki/Liste_der_Straßennamen_von_Wien)  
License: CC-BY-SA
2. List of first names classified by gender / Albert Martin  
[albertmartin.de/vornamen/](http://albertmartin.de/vornamen/)  
License: Public Domain
3. An example of the consequences of omitting extensive (and expensive!) manual processing and checking is demonstrated by an online map produced by the company Mapbox ([mapbox.com/blog/streets-and-gender/](https://mapbox.com/blog/streets-and-gender/)) – although they claim to have produced gender-labeled street maps similar to ours, using a fully automated process, even a quick sampling of their maps immediately reveals serious flaws (for example, on their London map, Bishopsgate is labeled female and Cornwall Road is labeled male, for whatever reason).
4. One of the main points of criticism after our release of the map was that we did not categorize the well-known Mariahilferstraße as female – it is actually named after a district (Mariahilf) that is named after a church (Mariahilfer Kirche) that is named after a painting (Maria Hilf by Lucas Cranach, of which a copy is located in the church) that depicts Maria, the mother of Jesus Christ, considered by some historians a real historical person. So how would you classify it?
5. Street geometries / OpenStreetMap  
[openstreetmap.org/](https://openstreetmap.org/)  
License: ODbL
6. Overpass API / Roland Olbricht  
[wiki.openstreetmap.org/wiki/Overpass\\_API](https://wiki.openstreetmap.org/wiki/Overpass_API)  
License: Affero GPL v3
7. mapmap.js / Florian Ledermann  
[github.com/floledermann/mapmap.js](https://github.com/floledermann/mapmap.js)  
License: Affero GPL v3

## Illustrations

Author map: genderATlas

# Street Names and Gender in Vienna

Vienna's street names are a reminder of famous people and meaningful events. This way they tell stories about the city and its development. However, men and women are not equally represented in the urban space. Of 4379 street names related to individual persons, only 361 refer to women.

In the spirit of gender-equal urban planning, there are currently attempts to counteract this imbalance by naming streets after female pioneers in newly developed city quarters, as for example in the "Seestadt Aspern". In 2012, this led to more traffic areas being named after women than after men for the first time in Vienna's history. In spite of these efforts, still only 5.2% of Vienna's streets hold a female's name. In relation to the length of the streets it is only 3%, since it is mostly alleys and few prestigious streets which are named after women.

**1** The **Wilhelminenstraße**, named after Wilhelmine von Montléart-Sachsen-Curland, is the longest street in Vienna named after a woman. In 1888 she financed the construction of the Wilhelminen-Hospital in Vienna, which is also named after her and is still in use today.

**2** The **Kretschmerweg**, named after Ingrid Kretschmer, who was a geographer at the University of Vienna, was not yet mapped in OpenStreetMap when this study began. Our research contributed to completing the data.

**3** In the second communal district of Vienna, an earlier head of district named some streets after female members of his family. For example, the **Herminengasse** or **Helenengasse**.

**4** From 2013 on, all streets in the **Seestadt Aspern**, a new urban development area in Vienna, have been named after women.

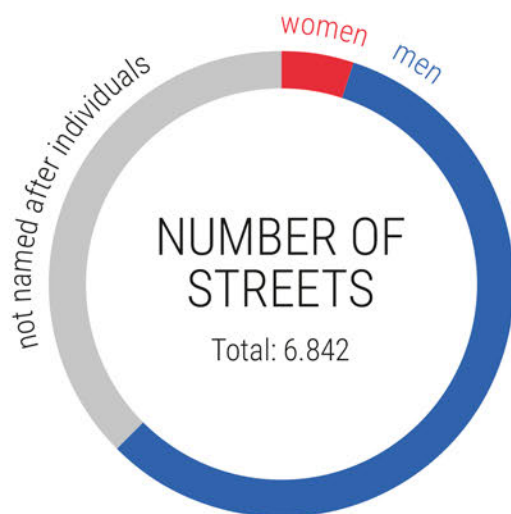

## STREET LENGTH

110 km 1.540 km

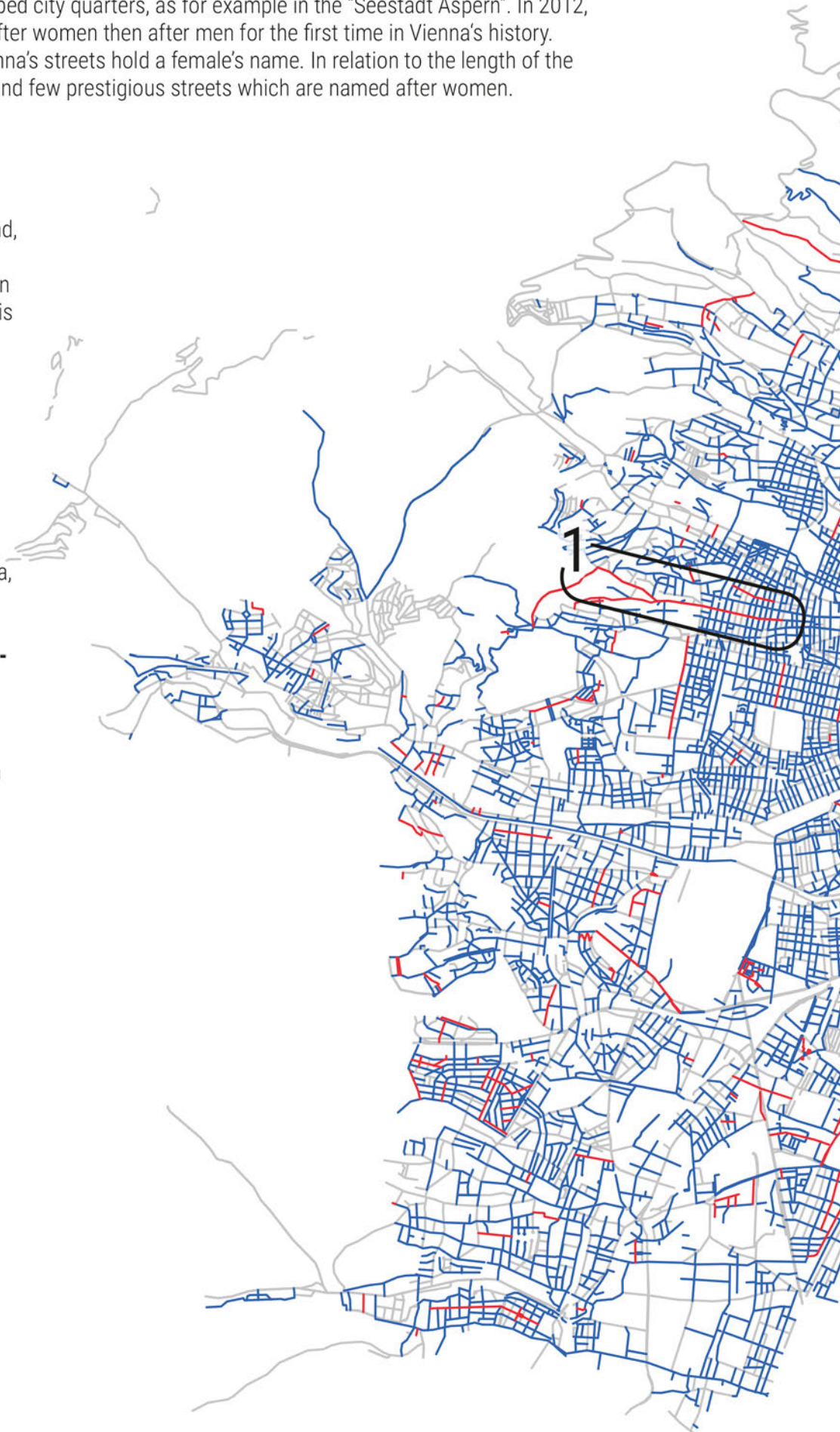

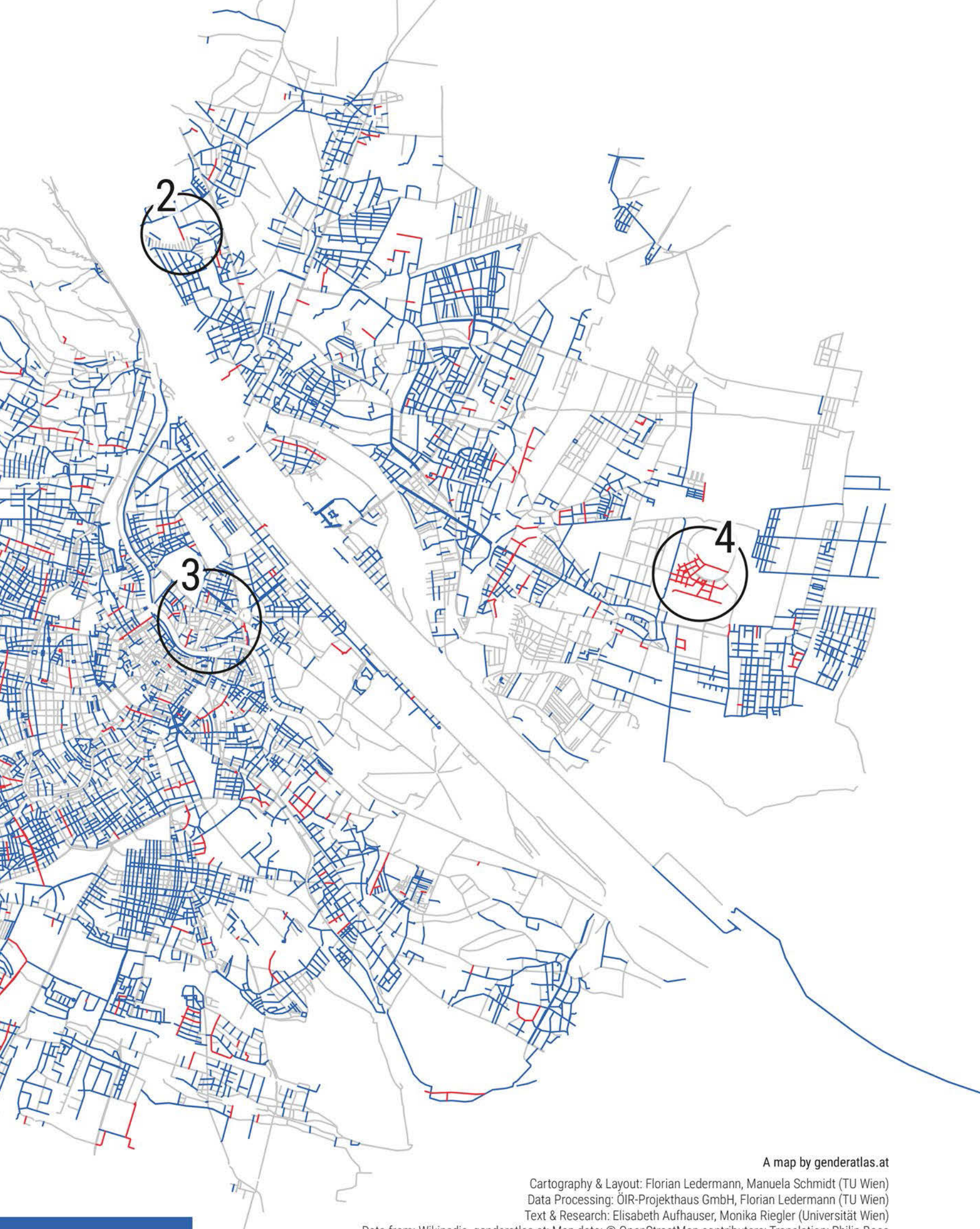

A map by [genderatlas.at](http://genderatlas.at)

Cartography & Layout: Florian Ledermann, Manuela Schmidt (TU Wien)  
Data Processing: ÖIR-Projekthaus GmbH, Florian Ledermann (TU Wien)  
Text & Research: Elisabeth Aufhauser, Monika Riegler (Universität Wien)

Data from: Wikipedia, [genderatlas.at](http://genderatlas.at); Map data: © OpenStreetMap contributors; Translation: Philip Boos

# Towards *unMaking Maps*

## A Guide to Experiments in Paracartography

John Krygier, Denis Wood



The problem with cartography ... the *problem*? The *problems*. There are so many of them! The list doesn't stop. It just goes on and on. It's hard even to know where to start. There's the data, first of all, with its usual presumptions of ... *objectivity* (whatever that's supposed to mean); and then there's the host of garbagemethods, with their pretensions of accuracy and precision; and finally there's the pointlessness of it all – of so much of it – of the making of maps simply to be making maps, like we can't live without them, like no one ever went anywhere until they had Google Maps on their phones, like the affectation of the *need* for maps, as though ... what? as though the world would grind to a halt without them? We don't get it!

And *we* like maps.

We like maps and we don't get it, *haven't* gotten it, for years. We especially haven't gotten the flood of academic claptrap that, like a vampire, sucks everything it can from the map. One of us, Denis, wrote the first of his series of papers (threatening finally to become a book) on the cartography of reality back in 1973. "The Cartography of Reality" argued that the only real experience any of us have of the world is our own – *our own experience* – and that the world that most maps brought into being was wholly imaginary, thanks largely to all the blather about objectivity and standards. And John first presented "unMaking Maps" at the New York Conflux back in 2006, a presentation of stuff he'd been working on for years, of him drilling holes in an atlas to make his Puncture Atlas, of pinning Hamlets from the Driftless Cuestaform Hill Land of Southwestern Wisconsin into insect display cases ("collected, pinned in place and labeled, the carcasses of places"), of his Atlas of the North, to say nothing of his Atlas of the South (the two of them made by running a single atlas across a table saw) ...

Our title here, "unMaking Maps", obviously refers to our textbook, *Making Maps: A Visual Guide to Map Design for GIS*, with the hope of ... undoing it? Something like that. At the very least of calling into question every one of its endless presumptions that if you're going to be making maps, we know the way to do it. And of course we *do*.

And we don't.

And it's this side of our practice, the side that wonders at ... at the neat line, for instance (where on the Earth is it?), that has us venturing into patacartography, the cartographic face of pataphysics, the discipline described by Alfred Jarry at the beginning of the last century as "the science of the realm beyond metaphysics;" or, and perhaps better because even broader, paracartography, those mapmaking practices that lie beside or beyond the mapmaking that cartographers have strained to confine. More generally, if cartography is contemporary accepted theory and practice, then patacartography and paracartography are map-making theories and practices that lie *outside* the limits of cartography. Dissatisfaction with these limits is rampant, especially when it comes to expressing ranges of human, social, and cultural phenomena. Yet experiments towards alternatives have been circumscribed. One constraint is that we have all so internalized cartographic conventions that we can't easily think outside them. Undoing, confounding, and/or contradicting these conventions may be one way to get into alternative mappings.

Alternative mappings could range widely. They could borrow from or hybridize conventional cartography, maybe even influ-

ence it, but they are never obliged to conform to its ideas of what maps are supposed to be. The maps of artists, of activists engaged in indigenous and counter-mapping, diagrammatic social mapping, and maps guiding or emerging from psychogeographic activities are but a few examples of the forms paracartography may take, but others may reach for the wild blue yonder.

The outcomes of the paracartographic practices and experiments we're exploring may expand the possibilities of mapping, may be funny or amusing, may undermine mainstream cartographic theory and practice, may be a waste of time, may help to understand the conventions and limitations of maps, may be stupid or puerile or may even leak out into the world, inspiring engagement with place and landscape. *unMaking Maps: A Guide to Experiments in Paracartography* is aimed at the growing number of people who want to explore the possibilities of mapping ... beyond accepted practice.

But why? Why would anyone want to do this?

The paracartographic answer would be, "Why not?", which is pretty unanswerable, but there are plenty of more reasonable answers, too. Perhaps the most important is that while most maps are unfathomably authoritative – they're right, they're accurate pictures of our world – they're simultaneously incredibly impoverished. That is, they may be right, but right about so unbelievably little. The world we actually live in is richly multidimensional, it has sunlight and starlight, it has shadows, it has birdsong and the roar of motorcycles, it has people and animals, and it's powerfully dynamic, changing not just day by day, but minute by minute and year by year. None of this makes it onto your Google map or onto the government topographic survey or onto the map hanging in the front of the classroom. None of this *or any of the rest of it*, which is the overwhelming most of it.

That is, most of the world doesn't make it onto those authoritative maps which are the cynosure of most mapmakers' eyes. Given this impoverishment, how is it that they're so authoritative? How is it that they're so authoritative and *have been so authoritative for so long*? For the way we treat maps today is the way we've been treating them for five hundred years, even though by our current standards those old maps were so terribly wrong! This reflects the reality that our attitude toward maps has less to do with the *maps* themselves than with the way they've been presented to us. There are things in the world that we're taught to think about as ... right. We think about these as reference authorities: catalogues, calendars, concordances, encyclopedias, directories, phone books, dictionaries (the *Oxford English Dictionary* (look it up!)), thesauruses (*Roget's!*), glossaries (at the end of every textbook), textbooks (*Organic Chemistry* – no subtitle needed), the *National Geographic*, the *Times* (New York or London), style guides (*The Chicago Manual of Style* (16th Edition!)), cookbooks, field guides, travel books ("What does Michelin say?"), footnotes, citations, legal citations, priests, eye witnesses, constitutions, parliamentary procedures ...

All of these – there really aren't that many – constitute objectifying resources that permit a claimant to insist that, "It is not I, not I who says this, but ..." before dropping, like a tombstone, the name of a reference object (Langenscheidt's, the Wikipedia, Larousse, Merck). Maps are exactly like the rest of these: the maps of Google, Hammond, Bartholomew, Rand-McNally, Esselte, the National Geographic Society, AAA, Mobil, Michelin, the United

States Geological Survey, other national mapping services, state and provincial highway maps, the *Thomas Guides*, Falk's, bus maps, maps of metro lines ... Maps objectify by *winnowing out our personal agency*, replacing it with that of a reference object so constructed by so many people over so long a time that it might as well have been constructed by no one at all ("It is not I who says this, but ... *the entire human race*"). Citation enhances a source's authority but also the authority of the one who cites it. The reflected light is blinding. Opposition is extinguished.

"You don't believe the map? Check it out!"

unMaking Maps want to recover what actually *is* lost when everything is given away, and we think the easiest way to do this is by making fun of cartography as she's writ. Laughter: it undoes every authority. For example, we all know the story of how we figured out the earth was a sphere (Eratosthenes, mariners, Columbus, Magellan, photos from space), and this story is told to undergird this accepted (if individually rarely rarified) belief. Despite this, an insane number of people continue to believe (and insist) that the earth is flat, surrounded by a wall of ice we call Antarctica. But instead of *defending* one position or another – hotly, with indignation – what if you simply ... squash them together as John has here? Immediately the corners of the mouth rise.

Contrariwise, what if you take something that's indubitably flat – like the US state of Wisconsin – and "project" it onto a globe, as John has here? Again, the corners of the mouth rise.

In both cases, instead of adding to the volume of stuff *written* about maps, John did what had to be done, used his hands to defeat the verbal onslaught from the academic hacks, made things, performed a material intervention against the flow of words. And with the mouth in a smile, it becomes much easier to question other cartographic shibboleths, like scale, margins, orientation, legends, size, readers, words, symbols, purpose, audience, materiality, need for, legibility, intelligibility – hell, everything. Playing – *playing!* – with these opens a thousand doors onto extraordinary paracartographic possibilities. We've begun these investigations, but there's nothing to stop you from doing the same thing. In a game like this, the more the absolutely merrier.

**Welcome to the paracartographic wonderland!**

#### Links

Drilled Atlas: Puncture Atlas of the U.S.

A video of John Krygier drilling through an atlas

[youtube.com/watch?v=1e8-QPsZeR8&spfireload=5](https://youtube.com/watch?v=1e8-QPsZeR8&spfireload=5)



Sawed Atlas: Atlas of the North | Atlas of the South

A video of John Krygier sawing an atlas in half

[youtube.com/watch?v=A\\_OtiqobTvU](https://youtube.com/watch?v=A_OtiqobTvU)









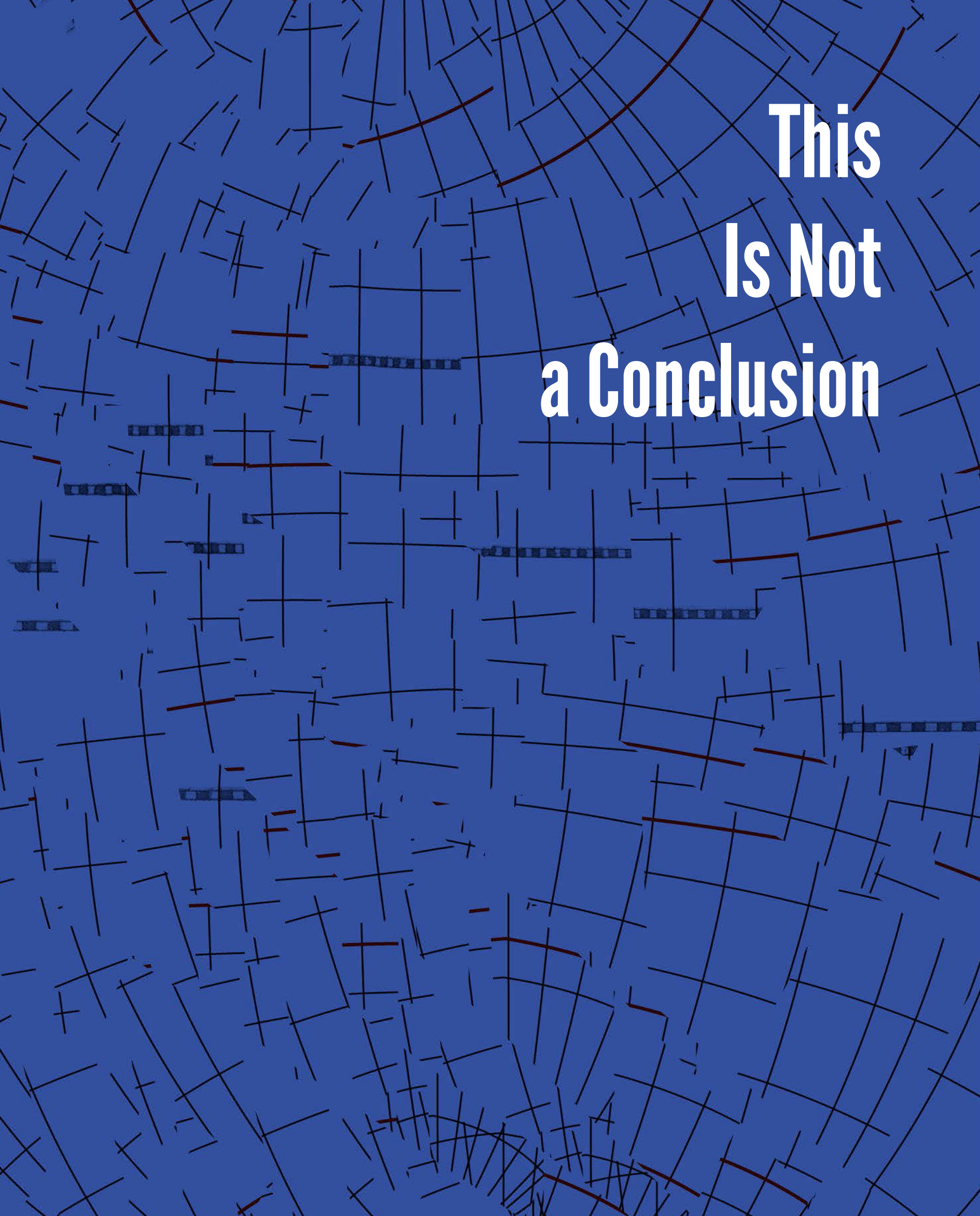

**This  
Is Not  
a Conclusion**

# Discussing Counter-Cartographies

Before finally printing Not-an-Atlas, we invited critical cartographers engaged in activism, art and academia to reflect counter-cartographies in general and Not-an-Atlas in particular. We wanted to complete this publication by deepening our understanding of maps and atlases, as well as map-making and atlas-making. At the same time, we wanted to pose new questions and point towards future ways of developing a counter-cartographic culture. We do not claim integrity. Instead we want to close this book by leaving it open for more. This is not a conclusion because Not-an-Atlas does not end with this discussion. Moreover, it is part of a cartography in movement that started long before and might keep on moving for quite a bit.

The people behind Not-an-Atlas, like the editors of *An Atlas of Radical Cartography* (Mogel & Bhagat, 2007) do not believe that counter-cartographies stand or speak for themselves. We believe that maps can be a point of departure and even a practical tool that helps to analyze and support local and global change. But only if we differentiate between the map and the territory (see article page 86), maps can become part of a "fluid movement whose tactics range from art-making to direct action to policy-making. This slow, cumulative, and constant work across many scales of action is what creates social change" (Mogel & Bhagat, 2007: 12). So, in a nutshell, Not-an-Atlas wants to support emancipatory transformation on the ground by supporting counter-cartographies within and beyond these pages (see notanatl.org).

To find an appropriate way of not-ending this publication, we asked critical cartographers to reflect on some questions, to ask their own questions, to tell us about their doubts, to act and to react. We wanted to initiate a reflective dialogue, and we are delighted to unite the following most proficient individuals and collectives for this experiment.

**kollektiv orangotango+:** Could you please introduce yourself?

**André Mesquita:** I am a historian and researcher, I write about art and political activism. In practice, I have used counter-cartographies in my work while sometimes conducting workshops with students, artists and social movements. I also make many diagrams to organize my work as a researcher and curator. Right now, I'm making a giant diagram for an exhibition I'm curating! (see article page 26)

[andremesquita.redezero.org](http://andremesquita.redezero.org)

**Denis Wood:** I've thought, written and curated shows about maps for the last 50 years. I've published seven books about maps, some in several editions. I've also made a few maps. I still don't like them. (see articles pages 165 & 322)

[deniswood.net](http://deniswood.net)

**Felipe Martín Novoa:** I am an anthropologist at the National University of Colombia. For more than a decade I have participated in processes of education, communication and self-organization of indigenous communities in the Colombian Southwest. In order to criticize the neocolonial processes in South America, I studied the strategies of privatization of territories within the frame of imperialism. I collaborate in the planning and construction of the Self-Communication School of the Putumayo. I am a co-author of *Geopolítica del Despojo – Biopiratería, Genocidio y Militarización* (CEPA Editores, 2016).

[geopoliticadeldespojo.com](http://geopoliticadeldespojo.com)

**Francis Harvey:** I have been curious for maps for most of my life, especially "unconventional" geographical representations. Now I work at the Leibniz Institute for Regional Geography in Leipzig, Germany after teaching at universities in the US and Europe for a number of years. Most of my research does not directly follow this curiosity, but it informs it in various ways.

[ifl-leipzig.de/de/das-ifl/mitarbeiter/harvey-francis.html](http://ifl-leipzig.de/de/das-ifl/mitarbeiter/harvey-francis.html)

**Iconoclasistas:** We are a duo formed by Pablo Ares and Julia Risler in 2006. In our projects we combine graphic art, creative workshops and collective research. All our productions are licensed under creative commons and are distributed via Iconoclasistas.net. In 2008, we started to experiment with different cartographic tools in spaces of collective work. This is how the collective mapping workshops and the processes of collaborative territorial research were born. In 2013, we published the *Manual of Collective Mapping – Critical Cartographic Resources for Territorial Processes of Collaborative Creation*. We are part of a dynamic network of affinity and solidarity spread all over the world, which allows us to adjust the elaboration of playful and pedagogic resources from a "tactical horizon". (see articles pages 86 & 183)

[iconoclasistas.net](http://iconoclasistas.net)

**Lize Mogel:** I am an interdisciplinary artist and counter-cartographer, working between the fields of cultural production, popular education, public policy and mapping. I use maps to make the politics of place visible, including public green space in Los Angeles, future territorial disputes in the Arctic and water and wastewater infrastructure systems in New York City. I co-edited the book/map collection *An Atlas of Radical Cartography* (JOAAP, 2007) with Alexis Bhagat.

[publicgreen.com](http://publicgreen.com)

**Liz Mason-Deese & Tim Stallmann from the Counter Cartographies Collective:** We are a collective that began in Chapel Hill, North Carolina, in 2005. We use mapping to intervene in spaces and flows of knowledge production, to destabilize centered and exclusionary representations of the social and the economic, and to construct new imaginaries of collective struggle and alternative worlds. Our major projects include disorientation guides, situated drift-interventions, and community cartography convergences. (see articles pages 26 & 212)

[countercartographies.org](http://countercartographies.org)

**kollektiv orangotango+**: Jeremy Crampton and John Krygier once wrote that critical cartography is "a one-two punch of new mapping practices and theoretical critique" (2005). As critical geographers we wanted to focus Not-an-Atlas on counter-cartographies because we felt a lack of presence of counter-mapping practices compared with the theoretical critique of maps. This might be a quite limited view from a critical geography perspective. However, we wanted to show that working critically with maps can be more than deconstructing them and that critique can also lead to new and critical forms of map-making. So we invited some of the people with whom we hope to share the same critique of maps. But do we really? Let's keep it simple: What do you not like about maps?

**Denis Wood**: I hate the insistence of maps that they've got it right. They never do.

**Tim Stallmann**: I think that maybe the counter-cartographic question here is not so much "what do you not like about maps" as "what do you not like about how maps are being used".

**Liz Mason-Deese**: Well, I think maps are produced with certain uses in mind, and those shouldn't be ignored. Along that line, I think it's important to not forget that critique aspect of counter-mapping. So I think what I don't like about maps is that they try to present themselves as neutral, as somehow not always already political. And I think the critique of that gets lost in some activist or participatory mapping projects.

**Francis Harvey**: I don't like their reification and essentialist understanding for many people from all walks of life, even in the humanities, and the lack of critical distance to their selectivity and biases. It seems to me that too often maps are needed in a rush and people end up following the conventions they would usually criticize or strive to go beyond.

**André Mesquita**: I do not like the obsession with which the capitalist and neoliberal world approaches the use of maps. This means the manipulation of data and how those cartographies end up being used only as means of surveillance, imprisonment, annihilation and genocide of communities and populations.

**Lize Mogel**: Maps can obscure the data and stories behind them in search of a totalizing surface. Also, given the ubiquity of mapping in the digital age, there's an over-reliance on geography as the frame.

**Tim Stallmann**: There's plenty not to like, but one thing that comes to mind for me particularly is the way that single-variable choropleth maps (colored areas) have become a go-to solution for many non-profit and government agencies which are trying to "democratize" neighborhood-level data or make it more "accessible".<sup>1</sup> Choropleth maps are easy to make, and they adapt to nearly any quantitative indicator. So, increasingly they've become the first mode of representation for data portals or neighborhood atlases that are focused on spatial inequality – like the 500 Cities project, Healthy City, the USDA Food & Environment Atlas, etc.

These maps work well at showing overall spatial patterning in a particular indicator but end up conflating *place*-based differences with Cartesian geographic *space*. This can lead to the hiding of deep histories of exclusion, oppression and resistance, which have much more to do with particular racialized bodies and particular physical structures in place than they have to do with the latitude and longitude coordinates defining a given neighborhood or region.

**André Mesquita**: We also have to remain alert regarding our tendency of wanting to map absolutely everything that is around us, because maps are tools with ambivalent purposes.

They can serve the purpose of freeing, but they can also serve the purpose of controlling and destroying – "to make war", as Yves Lacoste (1976) said about geography. Personally, I prefer not to create mappings of social movements, because many times this kind of action can give too much visibility to collectives, spaces and actions that must remain invisible to the control apparatus and the capitalist/military radar. Perhaps we need to be more strategic than tactical about this kind of analysis, remaining aware of the actions and risks as well as the consequences of mapping. We should also realize that there are initiatives that deal with these questions very carefully and with a great degree of consciousness about the effects of producing maps about histories of resistance. This is, for example, the case with the collective mapping carried out by the Iconoclastas (see articles pages 86 & 183). During the collective workshops they organize with social and student movements, everything included within the map is discussed and agreed upon collectively. I believe these experiences of discussion and decision-making about the power of mapping are a fundamental pedagogical stage in the cartographic practice.

**Liz Mason-Deese**: André brings up an important point here. This is something we have had to deal with in the Counter Cartographies Collective when working with migrant communities. Many migrants do not want to be mapped for various obvious reasons, and in this case visibility could be very dangerous. Consequently, we chose to focus on mapping the regimes that attempt to police, control, or produce certain types of migrants. I think this tendency of wanting to "map everything", something that I see all the time with my students, is something that should always be questioned, and questioned collectively in relation to social movements.

**Felipe Martín Novoa**: I do not like the standardization and the discourse of objectivity, in addition to the impossibility of generating a dialogue beyond the work created, which produces a narrative and reactions or an analysis of it by the viewer. From a deconstructive perspective toward cartography and because the conceptions and creations of our worlds are valuable for the vindication of our positions toward reality, we cannot cede this role to "experts" who attempt to homogenize reality through a rational and Cartesian framework. It is necessary to break with this concept of the representor and represented.

**Iconoclastas**: I do not like it because maps are incomprehensible when they offer very little in terms of communication or because they are difficult to read – and when form becomes more import-

ant than content and the maps become aesthetic products while losing their political value. I also don't like it when a fashionable attempt to intervene through a geographical profile without any objective or tactical approach is called a "map".

**kollektiv orangotango+**: We agree. Knowing that all maps have an agenda, we feel that too many atlases lack clarity about this fact. Also there is a lack of reflexivity. That was one reason for choosing *This Is Not an Atlas* as the title of our collection. All of us counter-cartographers seem to have something in common. We criticize maps and at the same time we constantly read, use and make maps ourselves. We appreciate maps, so it seems we all share this contradictory love for them. So what is it that maps are good and better at?

**Iconoclastas**: Maps are good for prefiguring actions, recomposing outlooks, reflecting upon our strengths and recognizing our weaknesses and threats. Furthermore, maps potentiate the processes of territorial co-research. They facilitate reflection based on a common graphic medium. They turn the interventions into something playful, allowing to think from other perspectives: less rational, more sensitive, corporal, emotional and experimental. Maps rapidly summarize complex processes and allow sketching the guidelines of a territorial research project, which can be deepened over a long period. Maps help to compose spaces of collective work in which the participants' bodies play a key role and activate themselves through the articulation with the others.

**Francis Harvey**: Graphically communicating geographical connections and relationships. The abilities and possibilities for simple maps have increased in the last 30 years. And simple can mean conventional, but it doesn't have to. I am convinced that for many contemporary uses the map you use isn't your grandfather's or grandmother's map. Today a map is more of a graphic technology for reducing spatial ambiguity and/or providing geographical insights in the context of institutionalized geographies.

**Lize Mogel**: Maps help us *believe* that we can fully understand large, complex systems. Counter-maps can help us understand the politics of place.

**Felipe Martín Novoa**: To me, what makes maps interesting and full of possibilities is precisely the narrating capacity of cartographies and the possibilities of building diverse modes of thinking about the territories we inhabit. A few months ago, I was immersed in an exercise of mapping the collective history of indigenous communities in the municipality of Puerto Asís in Putumayo in the Amazonian region of Colombia. This mapping was done by taking the marks in their bodies, building a collective history about identity and understanding the human body as a map. I also participated in another project that focused on the creation of a cartography of analysis of the conflict surrounding the oil industry. This mapping was based on multimedia resources such as video, animation, interactive cartography, etc. These pieces of work make us think about maps as flexible tools in continuous construction. Currently, there is a resurgence of critical cartography, created because of the needs of people and groups to present diverse critical

analyses of the imposed reality. They are building new proposals of re-territorialization and empowering diverse groups, based on ethnicity or gender diversity, or the hybrid urban and/or rural "subcultures" and their philosophical and ideological diversities. They are thus generating new cognitive processes for a world in permanent crisis.

**André Mesquita**: I think good maps are those that produce good uses. Maps that, through their limits, information, and blank spots, allow me to make my own counter-cartographies about the world. I see these possibilities in many of the projects of cartographic artists. Many times, I do not just want to map a known territory but to invent other territories, imaginary worlds, dreams and new constellations. This kind of radical imagination made possible by cartography is something politically powerful.

**Liz Mason-Deese**: Maps are good at changing our relationships with the earth, with the territory, with one another. Of course that can be good or bad. I think maps are at their best when they are part of a collective process, when they bring people together in new encounters that can produce new ways of seeing and inhabiting the world.

**Denis Wood**: Maps are good at identifying who owns what, at telling people where they're supposed to be, at laying down the law. But as Proudhon said, property is theft; people ought to be where they want to be. And, as Proudhon also said, laws "are spider webs for the rich and mighty, steel chains for the poor and weak, fishing nets in the hands of government", which could also be a good definition of most maps. So maps are good at doing bad things!

**André Mesquita**: I also like to think of the many connections present in the maps as energy flows, like the great organograms produced by the Bureau d'Études (see article page 26). You can look at those flowcharts as if they were a visualization of a company's actors; however, the administrative aesthetics used by the Bureau d'Études for re-appropriating a standardized or even military model of visual organization is what can change a "bad" map into a very powerful and interesting image. I think that this is an example of how counter-cartographies produce new subjectivities and new desires for researching and discovering even more of those processes. At the same time strategic knowledges are created that feed the actions of many movements.

**Tim Stallmann**: This question – What are maps good and better at? – begs the bigger question of what is a map! In the broadest sense of the term – maps as visual (or auditory) constructions with some sort of linkage to space or place – I think maps are good at being non-linear. They're good at opening up questions and conversations. And they're good at suggesting new ideas and new linkages. I think they are also powerful in that they can incorporate elements of visual (or sound or movement) art, moving beyond the rational and drawing emotional and spiritual responses in much the same ways that poetic forms of writing open up new possibilities.

**kollektiv orangotango+:** Maps are powerful tools that can be used for different purposes. And counter-cartographers like you draw a picture of a world of possibilities and non-dominant realities. What kind of inspiration do you get from critical maps?

**Iconoclastas:** All the available inspiration to continue thinking that it is possible to change the fixed state of things at the mental, material, social and political level, etc. The creation of critical maps potentiates the formation of complex panoramas of determined subjects and territories. Critical maps allow a memorable view from a bird's perspective as you travel in a reflective way over a determined space and time. During this flight, everything is possible: a simple distraction or a comment from another participant could initiate a memory or a surprising experience. A powerful picture can help to create similar perspectives. Also, the processes of dissent or temporary disagreement regarding perspectives on the territory create tensions and evolve when the playing field is defined by a "tactical horizon" of common goals.

**Denis Wood:** Critical maps give me the sense that it's not all over yet, that there's still reason to keep on breathing.

**Francis Harvey:** And that it is possible to be critical with and about maps in a proverbial sea of mediocrity. Cartographical clarity and power remain inspiring.

**Lize Mogel:** Critical maps tell very different stories and have different political effects than conventional and institutional maps do. Around the time that Alexis Bhagat and I started working on *An Atlas of Radical Cartography* in the mid-2000s, I was inspired by the maps of counter-cartographers like Bureau d'Études (see article page 26), Philippe Rekacewicz (see article page 244) and hackitectura. They were mapping global flows as well as creating more local counter-maps, such as the Spatial Information Design Lab's mapping of "million dollar blocks" and the Institute for Infinitely Small Things' "pay to play" mapping of Cambridge, MA. I am interested in the inherent and visible politics of these kinds of mappings, and how they serve spatial justice.

**Felipe Martín Novoa:** More than inspiration, it was kind of like diarrhea because the beginning of our work on cartography resulted from work we were doing in response to the militarization of the US military bases in Colombia. Thus the process developed along with several street art collectives and along with street interventions and transmissions. Out of this process, the need to shed light on what was happening at that moment arose. After compiling all the information, a friend suggested to create a map for sharing the wealth of information in a way that would be simpler to understand and also attractive from a design perspective.

**André Mesquita:** I consider myself a punk cartographer! I think the first critical maps I found in my life that inspired me were in some of the lyrics of punk bands, such as "Map Ref. 41°N 93°W"<sup>2</sup> by Wire or even "End on End"<sup>3</sup> – a song by Rites of Spring that does not directly engage with cartography, but I always imagined that the song could also be about someone in a room choosing data and information, making diagrams of secret powers over and

over again very intensely in order to understand the world's cycles – such as Mark Lombardi (see article page 26). Songs inspire me to think about maps all the time. For instance, the record *Yanqui U.X.O.* (2002) by Godspeed You! Black Emperor: On the back of the cover you find a diagram with the names of the most important record companies and world entertainment conglomerates, directly or indirectly connected corporations allied with the industrial-military complex. Even though the graphics were quite limited, that information blew my mind!

**kollektiv orangotango+:** But, apart from your personal connection between punk and cartography, is there another link between these seemingly distant cultures?

**André Mesquita:** One of the best qualities of critical maps is that they are tools in the best do-it-yourself spirit. I was very inspired by connecting with Chris Jones and the 56<sup>a</sup>, an info shop that has existed in the neighborhood of Elephant & Castle in London since 1991 (see 56a.org.uk). Chris has an archive of critical maps created by the 56<sup>a</sup>, and he organized a festival in 2005 called *You Are Here But Why?* The festival included an exhibition of alternative maps produced by collectives and during workshops. My contact with the 56<sup>a</sup> was important because I could see that Chris and his colleagues were producing maps that were not only related to the process of gentrification and real estate speculation of Elephant & Castle. They were also creating diagrams, timelines and diverse graphics about unusual occurrences that I also found quite interesting, such as punk rock and reggae events or the history of the workers' autonomy in Italy. There was not only one theme to be studied on these maps, and that made me realize that critical maps are inspirational because they open up to life – they are open to the organization of ideas, to the telling of stories and to suggesting alternative futures. What is inspiring about these maps – based on my interest in music and autonomous spaces – is that all of this goes against the establishment, and for me this is the spirit of what we do and the spirit of this anti-atlas.

**Tim Stallmann:** Critical maps, more than anything, give me the inspiration of knowing that other people in the world are out there doing this kind of work. To me, each map is a potential conversation: How did you come up with that design? How did you collect that data? What have the intended and not intended effects (and affects) been? And then, maybe, what should we build together next?

**kollektiv orangotango+:** We think these are exactly the issues that inspired us to publish *Not-an-Atlas*. So, with this in mind, we dove into the world of counter-mapping. We started to ask ourselves what it meant to (not) publish an atlas, and we reflected on existing counter-atlases. On our journey we shifted from *Critical Atlas* to *Anti-Atlas* to *An Atlas from Below* until we finally agreed on *This Is Not an Atlas*. So "atlas" was a central topic in our discussions during the editing process. Eventually we asked ourselves: If this is not an atlas, what *is* an atlas? Now we are curious to know from you: What do you think of when you hear the word "atlas"?

**Iconoclastas:** I think about something enormous, worldwide and expanded, a general panoramic view of things, a complex pic-

ture about a particular theme, a gesture of arrogance necessary to create a story, and therefore something that causes fear but also curiosity. And it is also an expression that is hip, hackneyed and in many cases has become meaningless.

**Tim Stallmann:** I always get excited when I hear the word atlas. It makes me think that someone, or some group of people, has taken the time to create or curate a set of maps which explore a theme through a diverse range of dimensions – I expect to see a wide range of maps in an atlas. But I also expect some sort of narrative flow I can sink my teeth into and really curl up with.

**Denis Wood:** What comes to mind when I hear the word "atlas" is Atlas, the African king, renowned as an astrologer, whom Mercator put in the frontispiece to the collection of maps that he intended as ... but a *part* of a gigantic cosmogonic meditation that he was calling ... *Atlas*. This *Atlas* of Mercator's was never intended solely as a collection of maps. It just so happened that the maps were the only part he managed to publish in his lifetime. And even so, "atlas" became a term for far more than a collection of maps: It could be a collection of *anything* – blood vessels or fish, for example – arranged in some kind of systemic fashion. Or, like Gerhard Richter's *Atlas*, a collection of photographs, newspaper cuttings and sketches barely arranged at all. That's what I think of ...

**Francis Harvey:** Here I want to point to Micheal Serre's atlas, a significant work by him, which takes up the cultural significance of the atlas in post-enlightenment science and society. Bruno Latour's discussion of globes in *Facing Gaia* seem to offer some important ideas in this direction. The globe seems to transcend our experiences but, like the atlas, it is never transcendent but just a model bound up in our material knowledge and experience. Its authority arises in its political capillary power based on the myth of atlas as interpreted by cartographers for hundreds of years. The potential of this power also comes from its relevance and function.

**Lize Mogel:** An atlas is a heavy tome, an authority, a reference, utility: it defines the territory, speaks the language of institutions, gathers dust. A counter-atlas is created from the political moment, it is made and remade, is rooted in the local, contains and transmits knowledges from the ground up.

**André Mesquita:** For me, an atlas is an open process that merges different ways of seeing, interpreting and intervening in the world. In his book, *The Practice of Everyday Life*, Michel de Certeau (1984) reminds us that the ancient name of atlas is "theater", and that a map puts together in the same scheme "heterogeneous places, some received from a tradition and others produced by observation". I like to think that a "scene" that results from this theater is a map that questions a cartographic tradition as well as our positivist outlook on territories. And that it becomes a critical tool that helps us to know, remember, problematize and especially act within the world. Through the same interpretation, an atlas can be a "machine of thought and action", and it needs to be activated through its use.

**kollektiv orangotango+:** So then, what do you envisage by Not-an-Atlas? And how does it feel to be part of Not-an-Atlas?

**Denis Wood:** It feels great. I'm happy to be part of any effort to contest, query, throw into doubt or otherwise discombobulate the tired orthodoxies of mainstream mapmaking.

**Francis Harvey:** Very good. It's an important contemporary project and contribution in a number of fields. Hope there will be an exhibit.

**Tim Stallmann:** I'm excited but also curious to see the finished product – how will Not-an-Atlas be more than the sum of its parts?

**Iconoclastas:** It feels great to share spaces with other collectives, and we truly look forward to learning a great deal from the experiences of others. We believe that many coincidences are widespread all over the world, and this gives us a common territory we should debate collectively: Why are so many people making maps? What use do maps have? Why do we need to explain/approach our territories from a cartographic perspective? Is this in any way linked to a wider process of a general loss of meaning, certainty or comprehensibility?

**Felipe Martín Novoa:** To conceive of a world atlas as a collection of critical or anti-systemic cartographies is a supremely profound and interesting topic. Conducting analyses of issues from a counter-hegemonic perspective while debating the construction of critical cartographies produces a dialogue of thinking about territories, practices and thoughts and using the language of maps. This generates a central problem of how to exert a dialogue of using maps. How do we make sure all these projects and participating groups engage in a dialogue that enriches our work?

**kollektiv orangotango+:** That's exactly the point! So, going beyond your positive feelings: What are your expectations towards this Not-an-Atlas?

**André Mesquita:** I think that an anti/not-atlas does not simply negate or reject official maps. Instead it creates new conventions and definitions and especially produces counter-memories, counter-narratives and alternative social exercises of counter-cartography. Rejecting a traditional and normative view of the world through counter-cartographies must be accompanied by a political position aimed at transforming the territory in which we live, even if this change – as we know – is slow, difficult and can be uncertain at times. An anti-atlas must direct us to the autonomous movements of resistance and collective action; it must be open to affect and be affected by social struggles and by people who are in the streets, fighting against the violence and inequality of this capitalist/patriarchal/racist system. Producing an anti-atlas means creating dissent and ways to act along with these movements; it is a way to destabilize what is assumed to be "the only" and "official" truth about our history.

**Felipe Martín Novoa:** Beyond thinking about maps as alternative, counter-hegemonic or anti-capitalist narratives, we need to think about the processes underlying the creation of each of our own

works and the wealth that each of these conceptions, reflected in our cartographies, represents. We need to think about the artistic aspect of these maps while also understanding the critical and collective analysis of the art that maps entail.

**kollektiv orangotango+:** For us as editors and activists it would be the greatest reward to know that this collection of counter-cartographies leads to new maps and solidary cooperation. That it inspires emerging cartographers and supports grassroots movements struggling for a more free, egalitarian and ecological global society. It is a great pleasure to be in touch with over a hundred counter-cartographers, to know about all these different struggles around the world, to be reminded that all these people are fighting day by day to create another world. But after reviewing so many maps from different places, it somehow looks like a globalized panorama of mappings of globalized struggles. So we ask ourselves if there is still space for the prospering of a local mapping culture? What kind of local differences and specifics do you observe in counter-cartographies? Or is it already a homogenized global culture?

**Tim Stallmann:** My experience has been that counter-cartographies are still very much a "minor" knowledge, one that is passed on by word of mouth and through personal encounters rather than through a formalized canon. There seem to be many counter-cartographies, although it is hard to say that any of them are *not* globalized – but rather there are multiple globalized cultures of counter-cartography, each located in different places. From my own position in Durham, North Carolina, a network of counter-cartographies tied to critical digital humanities, oral history, and anti-gentrification/anti-displacement movements feels "closest"; but I can see many other formations out there – countermapping/counter-cartographies springing from indigenous movements in Mexico, Canada and the Western US, a South American formation anchored with Iconoclastas, etc. The differences I've seen tend to spring from different problems and contexts; they are not necessarily a priori stylistic differences.

**Iconoclastas:** Maps with graphic languages are very communicative and universally understood because "an image is worth more than a thousand words". We also need to remember that the West has a hegemonic power that renders invisible other ways of understanding spaces and territories that are part of ancestral cultures or native peoples around the world. The great challenge will be getting to know other forms of approaching and representing territorial space: Maps with imaginary scales, inexistent references or an iconography that tries to mark the "unmarkable". A map should allow us to go beyond the visible and help us to walk through the gates of perception.

**André Mesquita:** As I always say, counter-cartographies need to go beyond representations. It is a learning process that is alive, and I think that their existence is tied to experiences from movements from the South and decolonial practices. The experiences of the Zapatistas and the Chiapas-uprising during the decade of the 1990s radically transformed the configuration of the social, political and economic map of the world. Without a doubt, these

acts totally transformed our local and transnational views, and they also have a great impact that needs to be considered when we think about cartographies. "Asking we walk", as the Zapatistas say, is something that helps us to understand the idea of a map as an action.

**Lize Mogel:** In *An Atlas of Radical Cartography* (2007), Jai Sen writes about a late 1980s project in which the group Unnayan (a collective of radical planners and architects) mapped informal settlements at the margins of Kolkata and used these maps to convince planning officials to provide services to settlers. He writes: "After all is said and done, the maps that we at Unnayan prepared used the same vocabulary of mapping the world as those with power-over did. The techniques of representation we used were all drawn from our skills as professionals trained in the formal worlds of planning and architecture. We rarely discussed or developed the maps with those whose lives and struggles we were documenting. There is nothing wrong (and everything right) about using such skills for counter-purposes. The questions nevertheless arise: What would the maps have been like if we had developed them with the settlers themselves? Did the settlers have a vocabulary of their own for mapping the world around them, as many folk cultures do? And would such maps have lived on, including through memory and oral culture, in ways that our maps could not and did not?" In most of the counter-mapping projects I have seen (or created), the map's political agency hinges on its use of accepted mapping techniques to speak the language of power. Does the choice to use this language preclude other kinds of more local representation? Can other forms of local representation gain the same power as the map? Map and data literacy is important, but what do we lose by prioritizing the form of the map?

**kollektiv orangotango+:** ... and this brings us back to the discussion: in what ways Not-an-Atlas is or is not an atlas? We say it is not an atlas as it does not claim any integrity or completeness. Instead it is to be understood as a possible, preliminary encounter of mapping experiences. It is not a finished project but has to be continued. In this sense, the online version notanatl.org will be dynamic, open for new maps, processes and representations. Not-an-Atlas should not be seen as the standard reference representing the state of the art of counter-cartography. It needs to be contested in its form and content. So we should ask ourselves: What do these supposed counter-cartographies need to truly overcome dominant representations, languages and aesthetics?

**Iconoclastas:** It is something that we need to propose as a constant challenge, as a permanent question in each process that we develop! For example, how can we incorporate the maps of the communities that have no access to the internet? Or the maps which are only passed along by spoken language? Or those who represent their territories through dances, songs or food? It would be wonderful to think of maps as living organisms, because we know that by creating a map, we take a "picture of the moment", but at the same time the depicted territories are in steady change and transformation. So, how can we represent this open sense that maps should have? How can we visualize that they are in continuously constructed subjectively?



**Felipe Martín Novoa:** It would be good to rethink the construction of these new territorialities from a perspective of diversity of identities. Thereby the construction of and the return to invisibilized or forgotten struggles signify critical mapping beyond simply considering it as a tool. In doing so, the aim would be to transcend the space of maps as such, highlighting the transformative capacity of collectivities dialoguing from different spaces and visions: maps talking with maps. This is a perspective of how to understand our realities and proposals.

**Lize Mogel:** Counter-mapping can be a kind of "sousveillance". Even as mapping from below gives our communities the power of visibility, these representations and data sets are then also available to the interests of capital.

**Tim Stallmann:** I myself often fall into the trap of describing counter-cartography by using a temporal story about maps: Maps *once were* tools of the Empire and the state *then* critical cartographers developed new ways of reading maps; *now* counter-cartographers attempt to use those same tools in the service of justice movements. But the more I study history, the more I realize that critical and counter-movements have been a constant presence, one that state power is continually trying to erase. I think that counter-cartographies (including *This Is Not an Atlas*) have a blind spot concerning our historical predecessors, and I want to challenge myself and others, over the forthcoming decade, to continue unearthing and sharing examples of counter-cartographies of the past!

**Francis Harvey:** I see this question in relation to Magritte's famous painting, e.g. *La Trahison des Images* ("Ceci, n'est pas une pipe") and the paradox of reality in the ideology of implicit essentialism that lubricates capitalist discourse. Maybe the most overlooked blind spot is how distortions and biases from maps and atlases lurk in the shadows, but are really in plain sight. The sense of "let the atrocious images haunt us", as Susan Sontag put it, has become more and more present in societies I know. Too often, too easily and too blissfully we seem to slide over the erasures and complexities of maps and atlases.

**André Mesquita:** Will we be able to go beyond discussions about representations and power of maps from this atlas and transform our lives? We are talking about social change here! In Brazil, as well as in most regions of Latin America, we are living a terrible social and political moment. I hope that the maps and histories of this anti-atlas help us to bring light to the present struggles and to optimize them.

**kollektiv orangotango+:** In discussions and mappings with militants and radicals from Latin America and Southern Europe we very strongly feel an urge to create common narratives across differences. In fact, we deal with a lot of shared issues and we should start to address them as such, conceiving of ourselves as engaged in common struggles. We see many parallels between your work and ours, as well as between the different counter-cartographies gathered in *Not-An-Atlas*. So we are already somehow engaged in a common struggle. Just like André, we, too, hope that the dis-

ussion we are having here will reinforce present struggles and inspire new counter-cartographers maybe precisely by emphasizing the common grounds of this cartographic multitude. We thank all of you for participating in this discussion and hope to find ways to continue this dialogue.

*Severin Halder, Paul Schweizer, Boris Michel and Laurenz Virchow have been speaking for kollektiv orangotango+.*

*Translation support by Carla Guerrón-Montero & Nicole Jullian*

#### Endnotes

1. There's an active and interesting discourse by, for example, the Detroit Digital Justice Coalition or the Our Data Bodies project, about whether these sorts of "data portals" increase participation or actually increase surveillance of marginalized communities, but I'm not talking about that here.
2. "An unseen ruler defines with geometry; An unrulable expanse of geography; An aerial photographer over-exposed; To the cartologist's 2D images knows; The areas where the water flowed; So petrified, the landscape grows; Straining eyes try to understand; The works, incessantly in hand; The carving and the paring of the land; The quarter square, the graph divides; Beneath the rule, a country hides; Interrupting my train of thought; Lines of longitude and latitude; Define and refine my altitude [...]."
3. "I've had days of end on end, Where nothing changed 'cause nothing ever began, Restless movement in an empty room, Gathering shadows of a darkened blue; And oh, it feels so strange, Oh, it feels so strange when it comes again; Cycles of end on end, Edges begin to blend, Time following time, A pattern becomes defined [...]."

#### References

- Certeau, M. de 1984. *The Practice of Everyday Life*. Berkley: University of California Press.
- Crampton, J.W. & Krygier, J. 2005. An Introduction to Critical Cartography. *ACME: An International E-Journal for Critical Geographies*, 4 (1): 11-33.
- Lacoste, Y. 1976. *La géographie, ça sert, d'abord, à faire la guerre*. Paris: Maspéro.
- Mogel, L. & Bhagat, A. eds. 2007. *An Atlas of Radical Cartography*. Los Angeles: Journal of Aesthetics & Protest Press.







# Glossary

## **596 Acres**

champions resident stewardship of land to build more just and equitable cities. As NYC's community land access advocacy organization, we help neighbors to see vacant lots / buildings as opportunities for creating community hubs, and support local campaigns to get there (40 successes so far). We create web-tools that support local land use decision-making ([livinglotsnyc.org](http://livinglotsnyc.org), [urbanreviewer.org](http://urbanreviewer.org), [onedollarlots.org](http://onedollarlots.org) and [nycommons.org](http://nycommons.org)) and go hand in hand with our organizing and advocacy work. [596acres.org](http://596acres.org).

## **Aaron Reiss**

is a visual journalist living in NYC with works in the *New Yorker*, *The New York Times* etc. He became interested in mapping during his undergraduate years, when he was awarded a small grant to map the city of New Haven as he wished it were seen through the eyes of Yale students. Since then, he has been making maps that explore how people imagine the places they inhabit – from rural villages in China, to the outer boroughs of New York City. He sees maps as a beautiful means for talking about important issues.

## **Adele Irving**

is a researcher at Northumbria University, England. Adele specialises in multiple exclusion homelessness. Through innovative methodologies, together with Oliver Moss she has undertaken a series of projects aimed at challenging and informing public understanding of homelessness. These include *Sounding Off: An Investigation of Visible Street Homelessness and People, Pavements and Property*.

## **Alfredo Wagner Berno de Almeida**

is an anthropologist, professor at Amazonas State University (UEA) and Maranhão State University (UEMA), and coordinator of the New Social Cartography Project of the Amazon.

## **André Mesquita**

is based in São Paulo and conducts research on the articulations between art, politics, and activism. During the past years, he was involved in a range of projects and exhibitions across the globe as resident researcher, (co-)curator and/or contributor, and has published numerous books. André currently investigates the theme of secrecy and its relationships with contemporary societies and artistic practices, and works as Head of Mediation and Public Programs at the Museu de Arte de São Paulo (MASP). He received his PhD in Social History from the University of São Paulo in the Faculty of Philosophy, Languages and Literature, and Human Sciences. [andremesquita.redezero.org](http://andremesquita.redezero.org).

## **Anna Hirschmann**

was part of *platzda?!*, a network of groups, activists and scientists in Vienna, organizing campaigns and actions between 2010 and 2013. It fought for access to vacant buildings, urban commons and a just city, working against the privatization and commercialization of urban space. Parts of the network later reassembled in the Right to the City Network Vienna.

## **Anne Laure Amilhat Szary**

is a full professor at Grenoble-Alpes University, France, and director of CNRS Pacte, a pluridisciplinary social sciences research centre ([pacte-grenoble.fr/en](http://pacte-grenoble.fr/en)). As political geographer dedicated to border studies, her comparative analysis of border dynamics in Latin America and in Europe has led her to formulate the notion of "mobile borders". Her latest research concerns the interrelations between space and art, in and about contested places. She is a founding member of the antiAtlas of Borders collective ([antiatlas.net/en](http://antiatlas.net/en)), and co-editor of *Borderities. The Politics of Contemporary Mobile Borders*, which stresses the unequal access to border crossing.

## **The Anti-Eviction Mapping Project**

is a digital cartography activist collective based in the San Francisco Bay Area, with new chapters in Los Angeles and New York City. Producing data visualizations, counter-maps and narrative pieces with multiple community partners, the project accentuates anti-capitalist, anti-racist, and feminist practices. The AEMP's work is intended to amplify and inform about on-the-ground displacement and resistance struggles.

## **Arnisson C. Andre Ortega**

is an assistant professor at the University of the Philippines Population Institute (UPPI), specializing in urbanization, migration, and critical demography. Together with Cian Dayrit, Ma. Simeona M. Martinez, and Kristian Karlo C. Saguin he has been conducting collaborative counter-mapping projects that aim to expose dispossession and militarization in the Philippines.

## **Boris Michel**

is a geographer at the University of Erlangen-Nuremberg (Germany). He is interested in the history of geography, urban studies and cartography. He never does maps but frequently teaches about them. He is also an editor of "sub\urban" an open-access journal for critical urban studies.

## **Brett Bloom**

is an artist and environmental activist working together with various publishing houses: Temporary Services, Half Letter Press, and Breakdown Break Down Press. He is based in Northeast Indiana (USA).

**Carolina Bertolini**

is a geographer. She holds a master's degree in society and culture in the Amazon. She is a researcher in the New Social Cartography Project of the Amazon.

**Christoph Lambio**

Geography and Information Technology are my passions and professions. When not coding, you'll find me on a yoga mat or on a surfboard. I am interested in how informatics and maps can be combined to make the world a better place.

**Cian Dayrit**

is an artist who collaborates with marginalized communities and has produced works of art showing cartographies of power, imperialism and spatial politics.

**Claudia Martinez Mansell**

is a humanitarian worker and independent researcher. Her collaborators Mustapha Dakhoul and Firas Ismail are from Bourj Al Shamali and currently completing their university studies.

**Colectivo de Geografía Crítica del Ecuador**

is an interdisciplinary collective working in Ecuador since 2012. We are producing a series of maps, articles, manifestos and pedagogical pamphlets with two objectives: on the one hand to visualize, denounce and denaturalize the multiple forms of oppression which express and reproduce themselves, and on the other hand to support the struggles of territorial defense.

**The Counter-Cartographies Collective (3Cs)**

is a collective that began in Chapel Hill, North Carolina, in 2005, and we use mapping to intervene in spaces and flows of knowledge production, to destabilize centered and exclusionary representations of the social and the economic, and to construct new imaginaries of collective struggle and alternative worlds. Our major projects include disorientation guides, situated drift-interventions, and community cartography convergences.

**CRAC Valparaíso**

is a cell and collaborative research platform working in the city of Valparaíso since 2007. Using research, action, critical pedagogy, and radical architecture, CRAC proposes a critical entanglement with the public sphere, the city, and the territory as a network of connections and associations of social experiments. Since 2014, we experiment with cartographies related to different issues in the city of Valparaíso and beyond. CRAC is developed by Paulina E. Varas and José Llano Loyola, who do research in arts and architecture in relation to situated knowledge.

**Denis Wood**

I've thought, written and curated shows about maps for the last 50 years. I've published seven books about maps, some in several editions. I've also made a few maps. I still don't like them.

**The EJAtlas**

is housed at the ICTA, Universitat Autònoma de Barcelona. It is co-directed by Leah Temper and Joan Martínez-Alier, and coordinated by Daniela Del Bene. It was an initiative of the EJOLT (Environmental Justice Organizations Liabilities and Trade Project) and is currently financed by the ERC Advanced Grant 2016-2021 to Joan Martínez-Alier for the project EnvJustice (a global movement for environmental justice) and by the Acknowl-EJ project (Academic-Activist Co-Produced Knowledge for Environmental Justice), 2016-2019 funded by the ISSC, directed by Leah Temper and Ashish Kothari. The EJAtlas is based on the work of hundreds of collaborators, including academics, concerned citizens, informal committees, NGOs and other activist groups, who have been documenting environmental and social injustice and supporting communities on the ground for years.

**Elisa T. Bertuzzo**

is a researcher and lecturer focusing on everyday practices of resistance against exclusionary politics, especially in South Asia.

**Élise Olmedo**

has been a post-doctoral researcher at Aix-Marseille University, the Norbert Elias Center (UMR 8562, CNRS) and the national Museum of European and Mediterranean Civilizations (Museum) since 2017. She defended her PhD in geography at Paris 1 University in 2015. The thesis is about contemporary practices of sensitive mapping by artists, urban planners and social science researchers. This work concerns realms of critical cartography, research-creation and emotional studies.

**Erica Hagen**

is a co-founder and director of Map Kibera, which created the first free and open map of the Kibera slum in Nairobi in 2009. She is also director of the GroundTruth Initiative in Washington, DC, where she works with partners to use digital technologies, citizen media and mapping for greater citizen voice and impact.

**Erin McElroy**

is a co-founder of the Anti-Eviction Mapping Project and the Radical Housing Journal. She is a doctoral candidate in Feminist Studies at UCSC, studying post-socialist Romanian technoscapes.

**Fernanda García**

is a primary school teacher and biology student. She works as director and sole teacher in a rural school in Cerro Largo, Uruguay, where she organizes mapping sessions with children.

**Florian Ledermann**

is a researcher and lecturer at the Research Group Cartography of TU Wien, Austria. His primary research interests are interactive cartography and the critical analysis of digital mapping practices.

**Fórum de Juventudes do Rio de Janeiro**

is a space to articulate oneself and to struggle for rights, especially against racism. The group is led by Black Youth social movements and residents of favelas and other peripheral areas.

**GeoComunes**

is a collaborative cartography project in Mexico. Its focus is the support of Territorial Defense Processes in both urban and rural spaces. In 2017, GeoComunes began two new lines of work: a research project centered on Special Economic Zones (SEZ) in southern Mexico, and a research project dealing with the real-estate boom in Mexico City.

**Geoide en Revolución**

started as a group of geography students at the Universidad de Buenos Aires (UBA), offering a space for debate and collective actions. Since 2007, we have been the representational body of Geography students at UBA. However, the group is also open to other students, regardless of whether they belong to any political parties or not. Due to individual and collective growth, Geoide extended its spaces of action: In cooperation with various grassroots organizations, we are working to transform the realities we study.

**Günter Nest**

is a teacher, curator, and instinctive photographer. Since 2001, he has acted as the managing director of Habitat Forum Berlin. Habitat Forum Berlin is a platform for the exchange of ideas and know-how around the question "how can inhabitants reclaim, negotiate and shape liveable housing and living conditions in urban or rural contexts all over the world"?

**HarassMap**

is an Egyptian community initiative working to create an environment that does not tolerate sexual harassment and to guide others who want to replicate our model around the world. Together we are building a future in which schools, universities, restaurants, shops, workplaces, and eventually all of Egypt are safe spaces that never tolerate sexual harassment and always help people when they are harassed.

**Hyderabad Urban Lab (HUL)**

was started in 2012 with the aim of conducting research on urban issues in a way that would bridge the gap between academia and life at the bottom. HUL believes that the urban grid is an interconnected network of resources and opportunities that should ideally be available and accessible to everyone who stakes a claim to them. Harsha Devulapalli and Indivar Jonnalagadda are research associates at HUL.

**Iconoclasistas**

consists of Julia Risler and Pablo Ares. Julia Risler holds a PhD in social sciences and is a lecturer and researcher at the University of Buenos Aires. She analyses and writes about the forms of biopower. Pablo Ares is a graphic artist. He draws comics and illustrations, and since 2000 he has also been designing maps. From 1998 to 2005 he was a member of Grupo de Arte Callejero (GAC).

**Imaginando Buenas**

is a multi-disciplinary collective founded in 2008 and based in Montevideo. It is interested in and working with a wide range of topics from politics to design, objects to territories, music and visuals, friendship and love.

**Ina Fisher**

has been a member of the Alarmphone for several years. The conditions of our work have changed a lot since the beginning: huge numbers of crossings in 2015 / 2016, then the dangerous passages in the Central Mediterranean in 2017. What will 2018 be like?

**Janina Dobrusskin**

is an urban geographer at the Humboldt University of Berlin, Germany. As scholar and activist she's interested in policies of migration and housing, in commons and feminist geographies.

**John Krygier**

Maps are strange things: I've been poking about exploring how they are made, how they work, and what their consequences can be for three decades. I teach stuff, some of it map-related, in geography and environmental studies at Ohio Wesleyan University in Delaware, Ohio (USA).

**Jon Swords**

is a geographer in the Department of Geography and Environment Sciences at Northumbria University. His research examines the funding and geographies of the creative economy as well as new forms of cartography and visual methodologies. Most recently, he's been researching how patronage platforms produce new forms of arts funding and how immersive experiences can enhance engagement with heritages.

**Julian Stenmanns**

teaches and does research at the Department of Human Geography in Frankfurt am Main, Germany. He is an economic geographer with a variety of research interests, including the politics of economic space, digital media and global inequality. Currently, Julian is researching the political economy of logistics and seaports with case studies in West Africa and Europe.

**Karl Heyer**

is a geographer who is usually most enthusiastic about what he is currently doing. This has led him to engage with a range of topics within geography and beyond, mainly dealing with questions of social & environmental (in-)justice. Being part of the PhD program "Boundary Formations in Migration Societies" in Osnabrück and Göttingen, his current research revolves around the Italian migration regime and the utilisation of space & time in controlling migrant im\_mobilities. Karl enjoys teaching and feels there is a necessity to amplify scientific and political knowledge in society, which he is working towards by facilitating (university) seminars, playing music with his bands, and co-editing this book.

**Kartographische Aktion**

offers maps for demonstrations and political actions. This mainly includes anti-fascist protests, but also anti-capitalist as well as ecological or feminist campaigns. Our maps help participants to orient themselves on site and to achieve their political objectives.

**Kristian Karlo C. Saguin**

is an assistant professor in the University of the Philippines (UP) Geography Department. He specializes in urban political ecology, agrarian studies, environmental governance, food geographies, fisheries and critical development.

**Laurenz Virchow**

is inspired by critical pedagogy, action research, and radical geography. He learns on a trial and error basis, by collectively mapping neighborhoods, working in them, and sharing enthusiasm.

**Leah Temper**

is a trans-disciplinary scholar-activist specialized in environmental justice politics, ecological economics and political ecology. She is based at the Institute of Environmental Sciences and Technology (ICTA) at the Autonomous University of Barcelona. She is the founder and co-director of the Global Atlas of Environmental Justice ([ejatlas.org](http://ejatlas.org)) and is currently the principal investigator of ACKnowl-EJ (Activist-academic Co-production of Knowledge for Environmental Justice, [acknowledgej.org](http://acknowledgej.org)), exploring how transformative alternatives are born from resistance against extractivism. She is also part of the newly formed MappingBack collective working on indigenous cartographies of extractive conflicts.

**Marc Amann**

is an activist in social movements, with focus on creative protests, civil disobedience and commons.

**Mark Graham**

is the Professor of Internet Geography at the Oxford Internet Institute (OII) and a Faculty Fellow at the Alan Turing Institute. Together with Stefano De Sabbata and Sanna Ojanperrä he works on a European Research Council-funded project (335716) called GEONET. The project aims to understand the geographies, drivers, and effects of Sub-Saharan Africa's emerging "information economies".

**Markus Wende**

is a Berlin-based animator, illustrator and comic artist with a predilection for social and human topics.

**Martina O'Brien**

is a visual artist whose practice explores links between people, nature and technology, largely developed through engagement with differing communities of interest.

**mapping.postkolonial.net**

is the product of a cooperation of the Munich-based activist group [muc] münchen postkolonial, the artists' lab Labor k3000 and the Ecumenical Office for Peace and Justice, Munich. Its research, concept, publishing, design and programming were done by a small team of activists, social scientists, historians, programmers and artists.

**Mike Jeffries**

is a zoologist by training and ecologist (most of the time) in the Department of Geography at Northumbria University. He is fascinated by how cities are used – modern architecture in particular – and also by lo-fi cut'n'paste visual methods. As with so many ecologists it is hard to tell when the child with a net and jam-jar dabbling in a pond turned into the researcher with a net and a white tray dabbling in multivariate statistics.

**Nermin Elsherif**

is a critical geographer, designer, and an urban researcher from Egypt. She is currently a PhD candidate in the field of Memory and Material Culture at the Amsterdam School for Heritage. In 2015, she started her own research project Other Maps of Egypt, implementing academic and alternative learning initiatives like the History Workshops Egypt with whom she worked to produce the map shown here. More about the workshops: [historyworkshopsegypt.net/blog](http://historyworkshopsegypt.net/blog)



**Nico Baumgarten**

For some time I studied but never graduated in geography. I did the layout of this book. That was supposed to be my only role in this project. But as it was a collective process and I have difficulties to keep my mouth shut I somehow became some sort of editor of this book too. In my other life I'm taking photographs, make exhibitions, hand-bind (photo)books, self-publish photo-books (sometimes with cats in them) and build tree-houses. [nicobaumgarten.net](http://nicobaumgarten.net)

**Nicolás Frank**

is a geographer and assistant professor at CURE, Universidad de la República, Uruguay, where he integrates the Labour Studies Group. He has co-organized research-action projects since his days of student activism.

**Oliver Moss**

is a researcher at Northumbria University, England. Oliver has a particular interest in phenomenological and non-representational approaches to the analysis of urban environments. Through innovative methodologies, together with Adele Irving he has undertaken a series of projects aimed at challenging and informing public understanding of homelessness. These include *Sounding Off: An Investigation of Visible Street Homelessness and People, Pavements and Property*.

**Pappsatt**

is an art and media collective working at the intersection between left-wing politics and design. The collective is engaging in artistic and political movements, that are claiming the right to the city for everyone. [pappsatt.org](http://pappsatt.org)

**Paul Schweizer**

went from exploring and writing on urban space as a youth, to writing and exploring on urban space with youth (and all kinds of people), co-creating our everyday environments.

**Philip Boos**

I studied Urban Geography and graduated from HU Berlin in 2015. Since then I have been working as a research associate in the fields of social innovation and sustainable consumption. I'm interested in urban studies, mobility research and spatial perception. At the moment I am focused on cycling and bicycle culture both from a scientific as well as an activist perspective. In association with *kollektiv orangotango+* I worked with several authors and translated their contributions for this book.

**Philippe Rekacewicz**

is a geographer, experimental cartographer and information designer born in 1960. His fields of research include socio-geographic and cartographic-artistic projects linked to the perception, imagination and representation of space and territories.

**Projeto Nova Cartografia Social da Amazônia**

The objective of the New Social Cartography Project of the Amazon is to enable the self-cartography of traditional peoples and communities. Social movements in this region represent collective identities referring to particular and territorialized social situations.

**Ralph Straumann**

is a visiting researcher at the Oxford Internet Institute, and head of data science at EBP in Zurich, Switzerland.

**Raphael Kiczka**

is currently working in the social housing sector in Vienna. As a scholar and activist he is dealing with housing policies, the neo-liberalization of urban policies, and migration.

**Renato Antonio Gavazzi**

is a geographer with a specialization in biodynamic agriculture. He has worked with indigenous peoples since 1983, training indigenous teachers in Brazil, Venezuela and Bolivia. As part of his work in the Pro-Índio do Acre Commission (CPI / AC), he conceptualized the Agroforestry Indigenous Agency (AFIA) for the territorial and environmental management of the Acre Indigenous Lands. He has organized several books and maps for indigenous schools, as well as plans for the territorial and environmental management of different peoples. He currently works as a consultant and pedagogical coordinator for the formation of an Agroforestry Indigenous Agent by the Territorial and Environmental Management Program of the CPI / AC.

**Sanna Ojanperä**

is a PhD student at the Oxford Internet Institute and the Alan Turing Institute. She is also a Future of Work Fellow with the OECD.

**Sarah Mekdjian**

is an assistant professor for Geography at the University Grenoble Alpes and PACTE laboratory (France). Her research deals with contemporary conditions of exile. She's questioning the asymmetric statuses of "refugees", "asylum seekers", "migrants", or "national citizens" produced by the Nation-States and international laws, but also the asymmetric statuses of "researchers" as "experts" and "immigrants" as "non-experts witnesses". Reasserting the principle of intelligence equality, she uses creative counter-cartographies with people in various administrative and social situations as a relational tool in trying to overthrow these divisions.

**Severin Halder**

My endeavours in activism and geography are driven by experiences with everyday resistance in Rio de Janeiro, Bogotá and Maputo. These inspirations guided me through the last decade while working within kollektiv orangotango, the Allmende-Kontor community garden network and academia in Berlin. Now I hold a PhD, I know how to draw and edit maps collectively but I still would love to plant more of my own food.  
orangotango.info

**Sheilla Borges Dourado**

holds a PhD in Law with specialty in Human Rights. She is a professor at the Post-graduation Program in Social Cartography and Politics of the Amazon, Maranhão State University (UEMA). She is also a researcher in the New Social Cartography Project of the Amazon.

**Silke Greth**

My first true engagement as a critical geographer started in the field of education against discrimination and the simple pleasure of teaching. Experiences outside the university showed me a need to create an open learning community within the academy. After some years I decided to dig deeper into the dirt and work at the very foundation of life, where I am now on my long way to becoming a farmer.

**Ma. Simeona Martinez**

is an assistant professor at the University of the Philippines (UP) Geography Department. She specializes in GIS, community mapping, remote sensing and agrarian transitions.

**Stefano De Sabbata**

is a lecturer at the School of Geography, Geology and the Environment at the University of Leicester. He is also a research associate at the Oxford Internet Institute.

**Stephan Liebscher**

was trained in migration and border regime research focusing on cartography, space making and movements. He is involved in projects investigating the participation of refugees and undocumented persons in local services.

**Till Straube**

teaches and does research at the Department of Human Geography in Frankfurt am Main, Germany. He is an economic geographer with a variety of research interests, including the technopolitics of economic space, digital media and global inequality. Till is currently working towards his PhD, doing research on predictive policing, digital geography and code studies.

**Tobias Morawski**

is a communication designer, artist and author. He studied Spatial Strategies at the weissensee academy of art berlin (KHB), and works in the Graffiti Archive (being part of the Archive of Youth Cultures e.V.). His book Reclaim Your City - Urbane Protestbewegungen am Beispiel Berlin was published in 2014 by Assoziation A.

**The Working Group Critical Geographies of Global Inequalities (CGGI)**

mainly deals with persisting relations of inequality and power from a critical perspective. We usually work with ethnographic and visual methods, as well as critical cartographies and discourse analyses. Our group serves as a space for discussion and mutual exchange in which we can develop collective standpoints but also accommodate different types of questions and approaches.



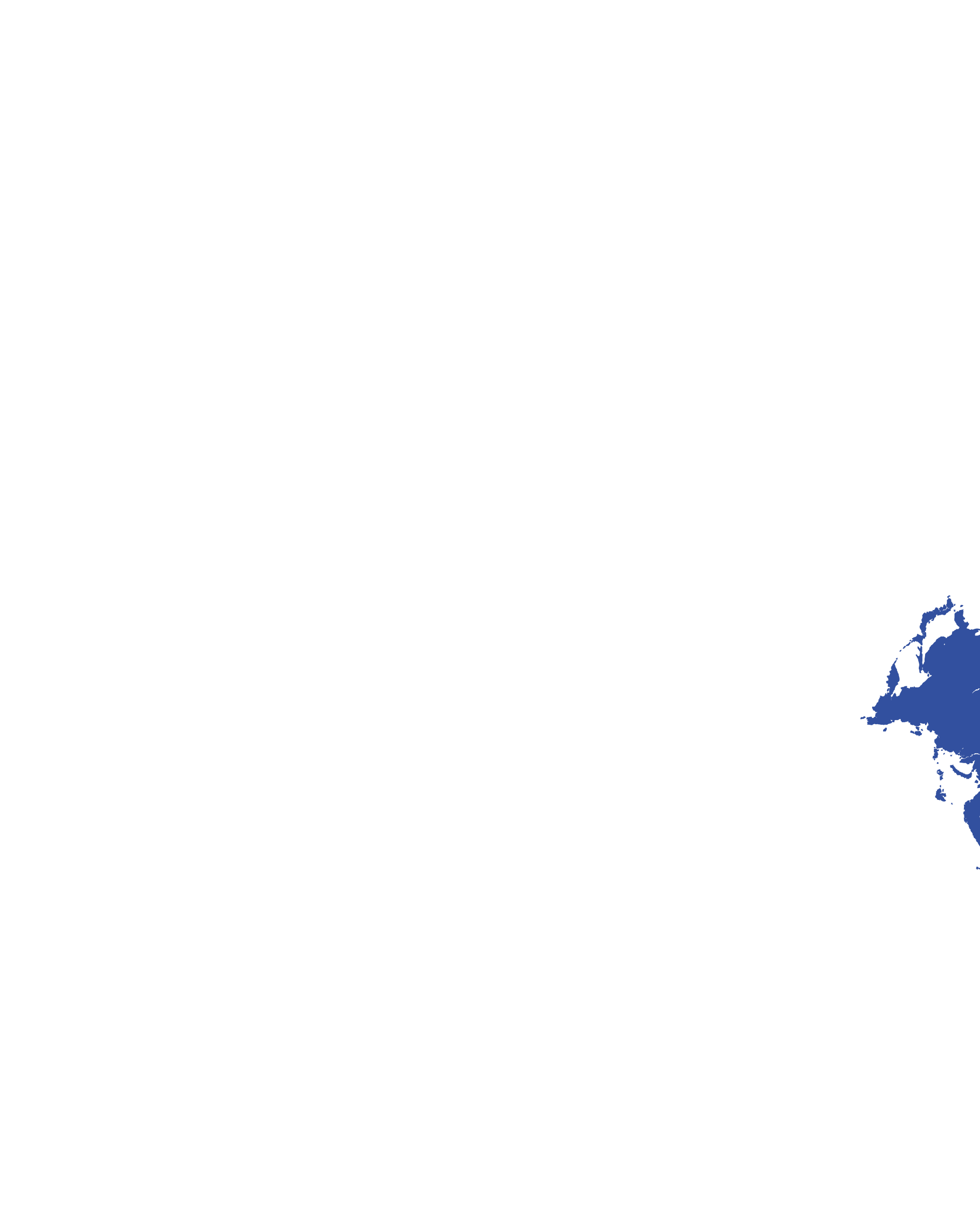

Visit [notanatlas.org](http://notanatlas.org)

*This Is Not an Atlas* ends here, but it continues online. On [notanatlas.org](http://notanatlas.org) we share more maps, struggles, projects, texts and inspirations. Here you can also download this book as an ebook – for free! It is published under the Creative Commons license feel free to distribute it to fellow cartographers.

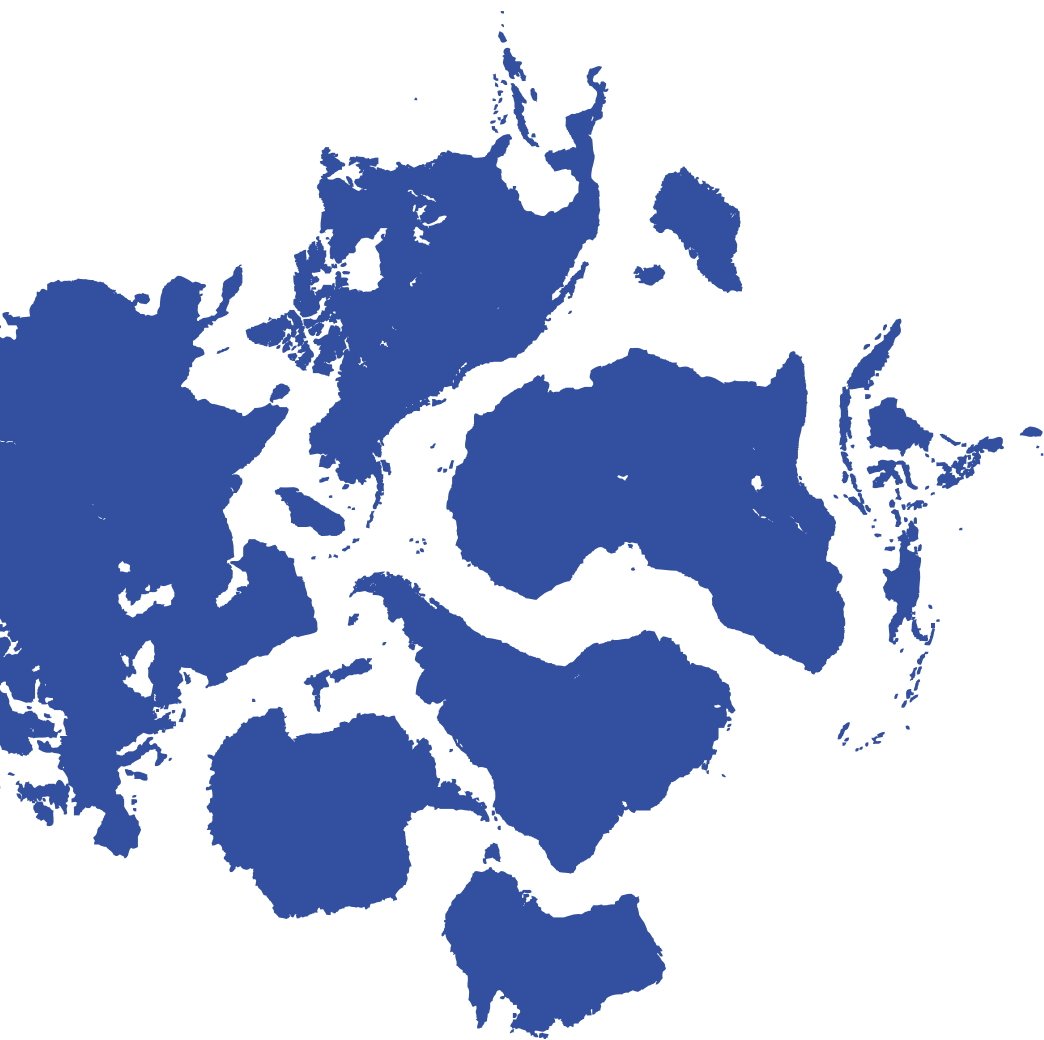



# Actors and Supporters

## **kollektiv orangotango**

kollektiv orangotango is a network of critical geographers, friends and activists who deal with questions on space, power and resistance. Our geographical activism seeks to support oppositional actors and processes that emphasize marginalized perspectives and instigate social change by prefiguring social alternatives. We conduct emancipatory educational work as well as concrete political and artistic interventions. These are supposed to enforce reflections on, and the change of social conditions. Through workshops, publications, mappings, excursions, and creative interventions within public space, we collectively learn how to read space and how to initiate emancipatory processes from below. By sticking to the traditions of activist research, we connect theoretical reflections and concrete actions. So far we have engaged in the fields of right to the city, (urban) agriculture, critical pedagogy, alternative housing and solidarity economy. All of this is happening through collective and self-organized practice. In other words: "We're going slow, because we're going far"!  
orangotango.info

## **LE MONDE diplomatique**

Le Monde diplomatique (LMd) is linking people who take a serious interest in world events across the globe: There are 37 foreign editions in 20 languages. That represents a world circulation of more than 2 million readers. LMd stands out in an increasingly uniform media landscape for its critical vision, in-depth analysis of world issues and reports that illuminate the state of the planet. Since 1995, the daily newspaper *taz.die tageszeitung* has published the German-language edition of LMd. Each month the German LMd covers all major stories from the Paris-based parent edition, expertly translated, with some Berlin-based commissions, too. Since 2003, the German editorial team has edited seven different issues of the comprehensive *Atlas der Globalisierung* with maps and infographics that explain the world around us. Twice a year, the editorial team publishes the journal *Edition Le Monde diplomatique* with its focus on special issues, such as China's foreign policy, the global food industry or Great Britain in times of the Brexit.  
monde-diplomatique.de  
atlas-der-globalisierung.de

## **Rosa-Luxemburg-Stiftung**

The Rosa-Luxemburg-Stiftung is one of the six major political foundations in the Federal Republic of Germany, tasked primarily with conducting political education both at home and abroad. The Stiftung is closely linked to Die Linke, the German Left Party. Since its founding in 1990, the Stiftung's work has adhered to the legacy of its namesake, German socialist leader Rosa Luxemburg, and seeks to represent democratic socialism with an unwavering internationalist focus. The Stiftung is committed to a radical perspective emphasizing public awareness, enlightenment and social critique. It stands in the tradition of the workers' and women's movements, as well as anti-fascism and anti-racism. The Stiftung promotes a critical analysis of society and fosters networks of emancipatory political, social and cultural initiatives around Germany. Internationally, it participates in cooperative development projects and advocates for a dialogue between the Global North and South conducted on equal footing. Based on the firm belief that social change requires a reflective confrontation with today's capitalist society as a whole, the Stiftung strives to develop alternative concepts and approaches for a comprehensive process of social-ecological transformation enabling the creation of a more united and just society.  
rosalux.de

## **Foundation anstiftung**

The Foundation anstiftung carries out research into commons, do-it-yourself and sustainable regionalisation. A key element of this is creating a new perspective on what Western societies understand by "prosperity". Since quality of life is not just about having a large number of different products, the Foundation networks and promotes subsistence practices in everyday life and draws attention to their importance for a sustainable society in a sustainable global context. The Foundation is involved in a wide variety of civil society-based innovative activities in urban and rural areas. These include open spaces, such as community gardens, intercultural gardens and open workshops on crafting and fabbing, as well as initiatives aimed at reviving neighbourhoods and artistic interventions in public space. We also coordinate a research network, document current research activities, organise research workshops and, jointly with other foundations, award a prize for research into the ecological economy. In our academic work, we cooperate with various networks of practitioners, institutes and research organizations.  
anstiftung.de









**This Is Not an Atlas** gathers more than 40 counter-cartographies from all over the world. This collection shows how maps are created and transformed as a part of political struggle, for critical research or in art and education: from indigenous territories in the Amazon to the anti-eviction movement in San Francisco; from defending commons in Mexico to mapping refugee camps with balloons in Lebanon; from slums in Nairobi to squats in Berlin; from supporting communities in the Philippines to reporting sexual harassment in Cairo. **This Is Not an Atlas** seeks to inspire, to document the underrepresented, and to be a useful companion when becoming a counter-cartographer yourself.

**ISBN 978-3-8376-4519-4**