

APOCALYPSE RELIQUARY 1984 - 2000

Danny Snelson

APOCALYPSE RELIQUARY: 1984 - 2000

Danny Snelson

Monoskop Library
2018



**APOCALYPSE
RELIQUARY
1984 – 2000**

Danny Snelson

**Monoskop Library
2018**

INTRODUCTION

INHABITING AN EARTH CONTINUOUSLY
SUBJECTED TO CATASTROPHIC EVENTS,
APOCALYPSE RELIQUARY PRESENTS A SURVEY
OF ARTIFACTS LEFT BEHIND BY SELECTED
GLOBAL CATAclysms FROM 1984 TO 2000.
OBJECTS ON DISPLAY RANGE FROM THE CIRCUIT
BOARDS OF Y2K TO EJECTA FROM THE
COLLISION WITH HALLEY'S COMET. THE
EXHIBITION INCLUDES SPACESHIPS FROM THE
PLEIADES PHOTON BELT, THE RADIOACTIVE
REMAINS OF COUNTLESS NUCLEAR
ARMAGEDDONS, RELICS FROM THE ZETA
RETICULI STAR SYSTEM, AND A WIDE ARRAY OF
ARTIFACTS DELIVERED BY DOZENS OF RELIGIOUS
RAPTURES.

EACH ENTRY IN THE APOCALYPSE RELIQUARY IS
INSCRIBED WITHIN THE ONGOING DISASTER OF
THE PRESENT. ORGANIZED CHRONOLOGICALLY,
THE CATALOGUE BEGINS IN 1984, IMMEDIATELY
FOLLOWING THE COLLAPSE OF THE PLANET
UNDER THE STRAIN OF THE POPULATION BOMB.
THE RELIQUARY - AND IT'S CORRESPONDENT
DIARY - WILL CONTINUE TO ANNOTATE THE
RUINS OF GLOBAL ANNIHILATION UNTIL A FINAL
APOCALYPTIC EVENT RENDERS ALL RECORDING
IMPOSSIBLE.

--- DSS

1983

Prelude

⇒EXCERPTS FROM⇐

⇒APOCALYPSE DIARY⇐



I WAS BORN ALONG-
SIDE THE FIRST GLIMPSE
OF Y2K, IN THE WANING
DAYS OF 1984.



MY MOTHER RECOUNTS
UNTOUCHED SNOW
UNDER A BLACK SKY AS
SHE CARRIED ME OUT.



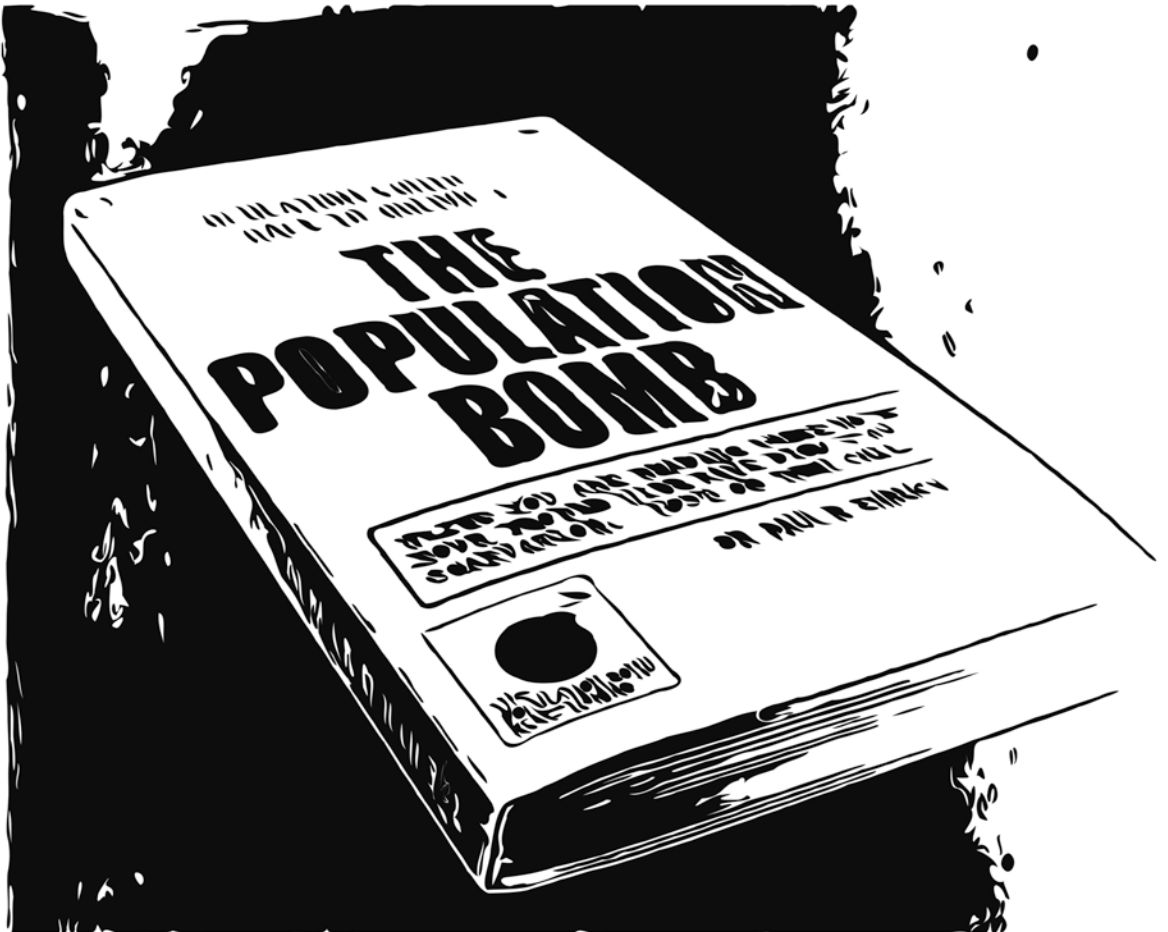

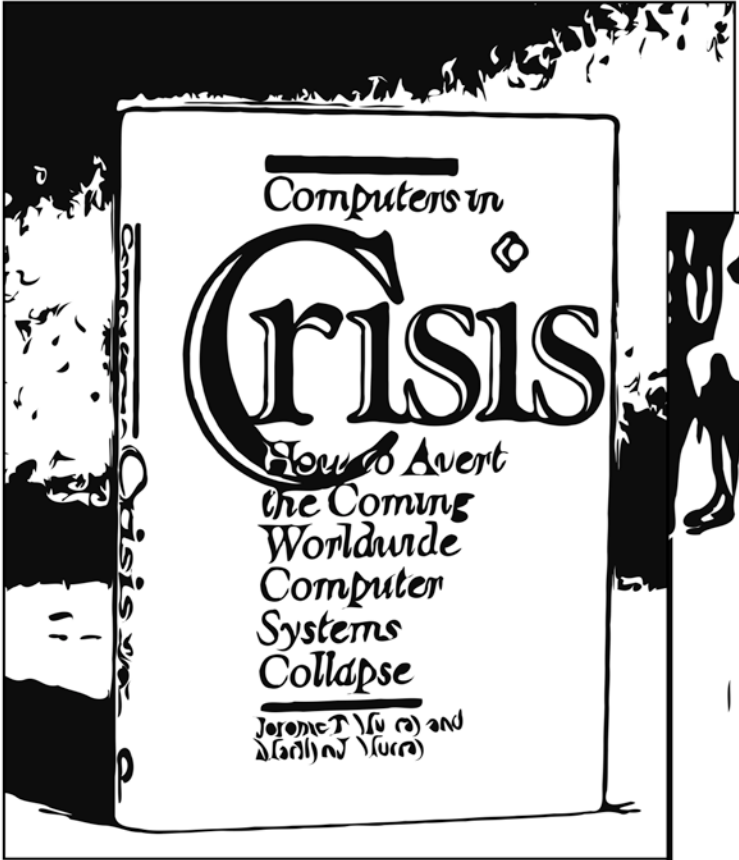

STOP: €0000218 Unknown Hard Error

WE HAVE
PLACED OUR
CONFIDENCE

...OUR
PHYSICAL AND
ECONOMIC
WELL-
BEING...

...AND FUTURE
HOME IN THE
DEVELOPMENT OF A
TECHNOLOGY...

...NOW SEEN TO BE
FATALLY FLAWED THROUGH
COLLECTIVE HUMAN
OVERSIGHT.

WHAT HAVE WE
DONE?

WHAT WILL
WE DO?



POPULATION CONTROL OR
RACE TO OBLIVION?

THE POPULATION BOMB

WELL YOU ARE READING THESE WORDS
FOUR PEOPLE WILL HAVE DIED FROM
STARVATION. MOST OF THEM CHILDREN.

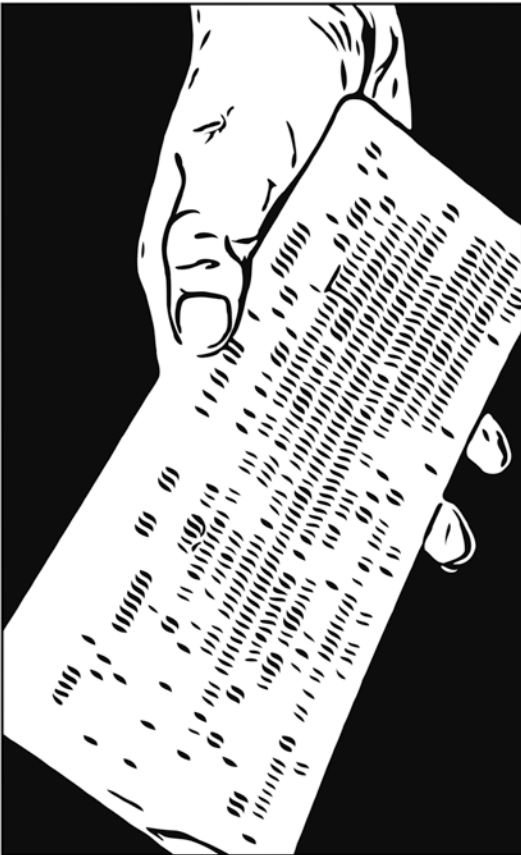

Y2K SURVIVAL GUIDE

Protect Your Family
From The Coming Crisis

J.C. Cunningham



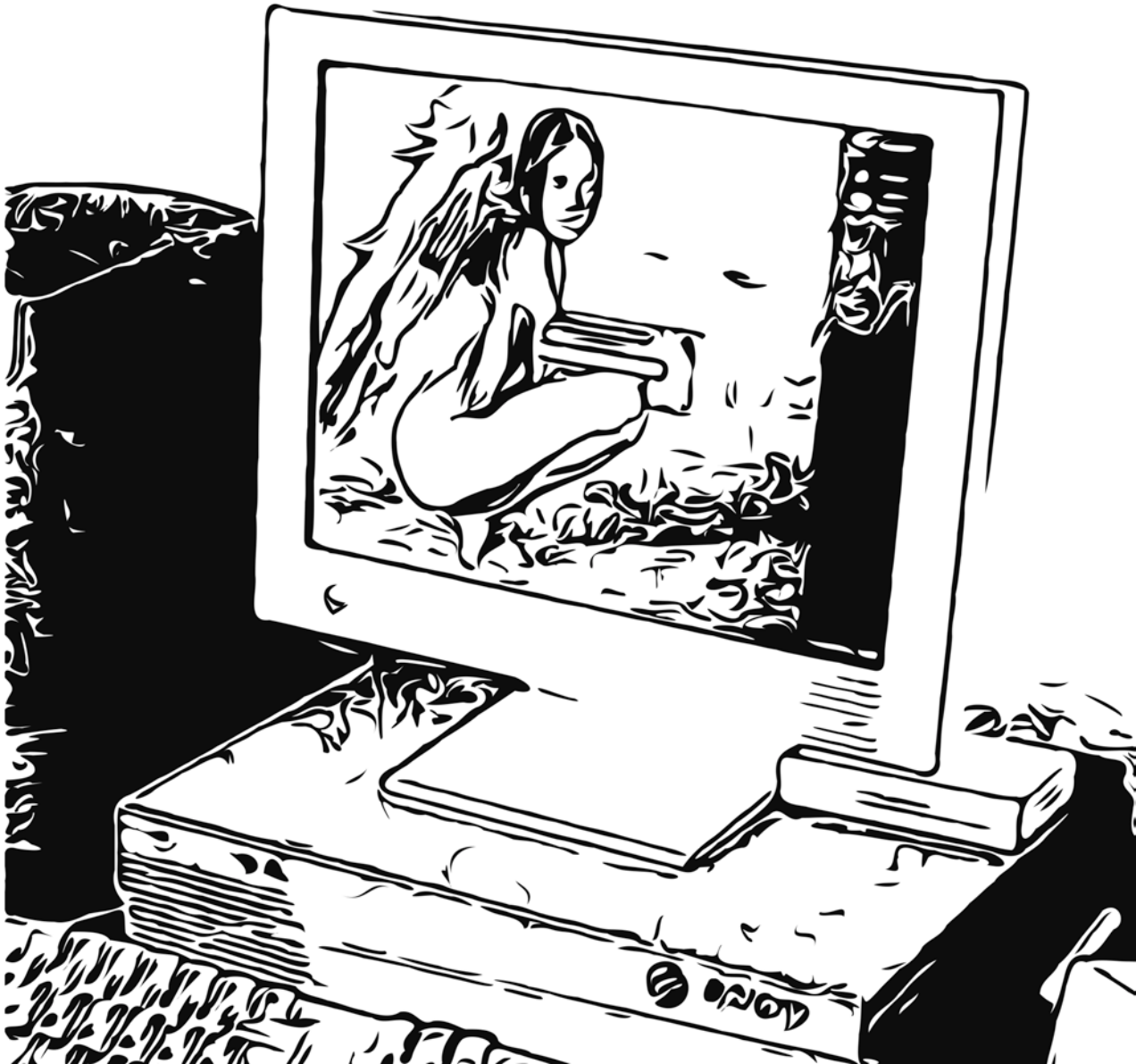

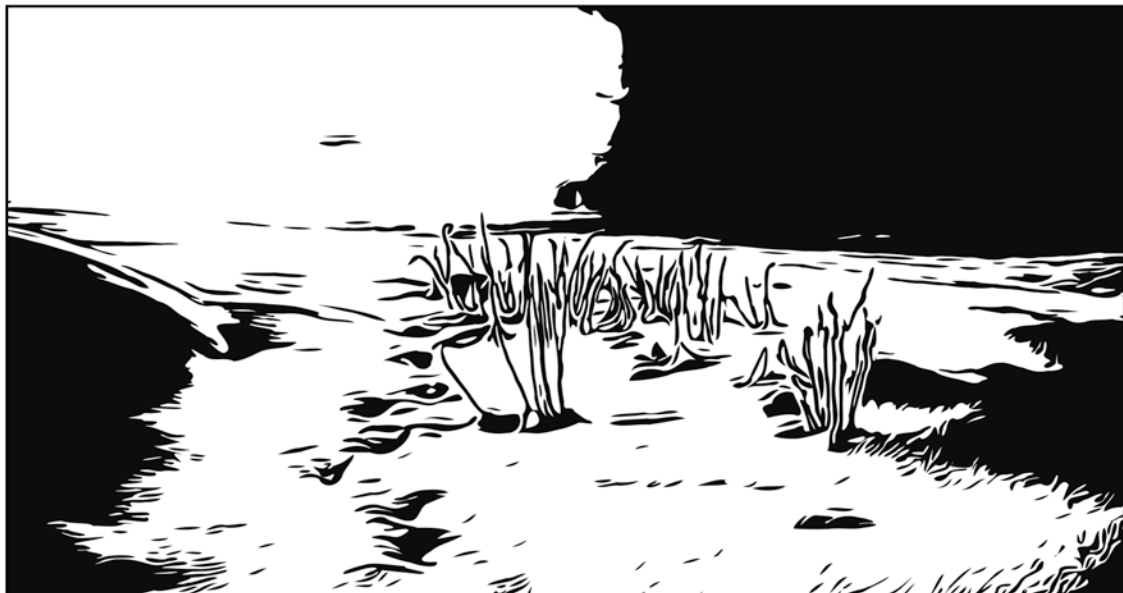





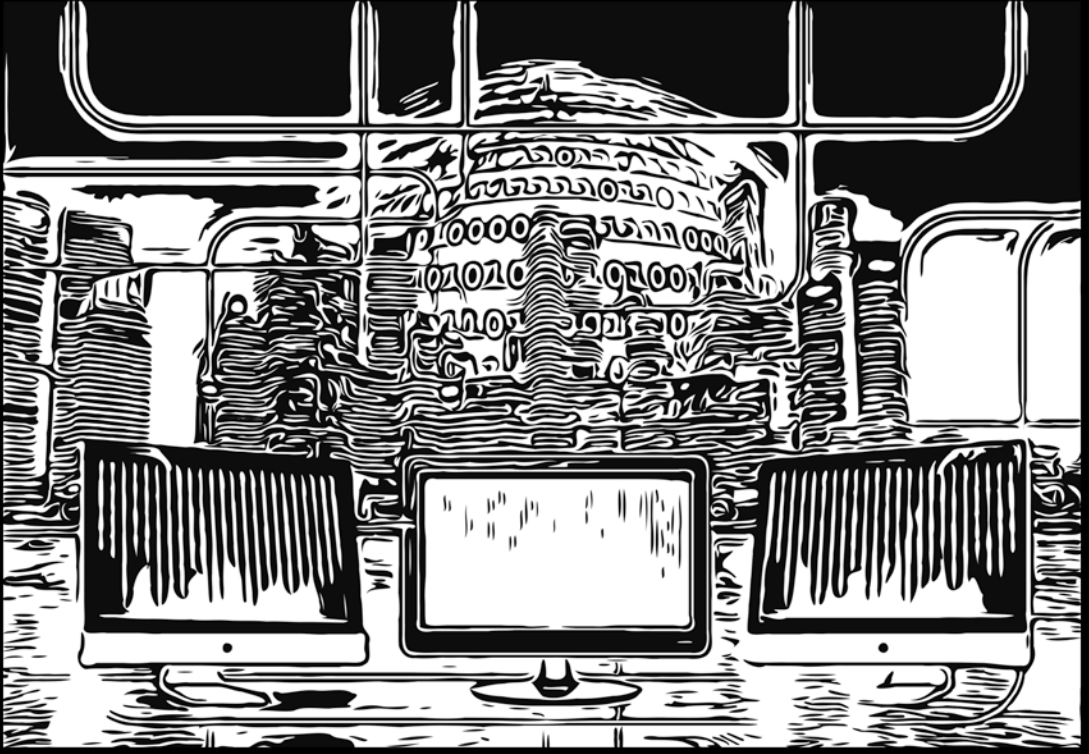



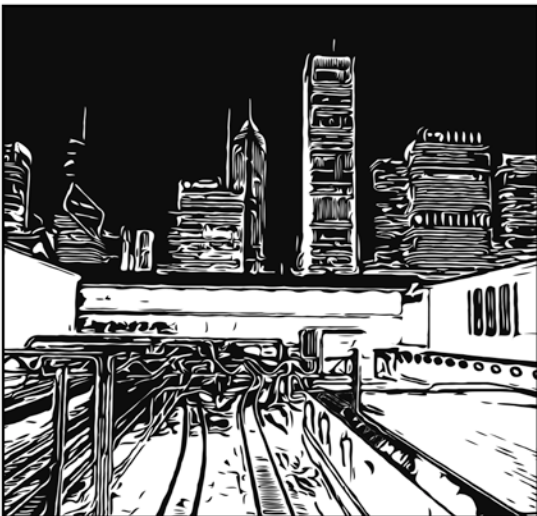





<p>adesso c'è più per e degli ideali nostri, Sudati, per una, fu una grande una da una parte</p>	<p>una famiglia Ma non si sa sempre per il femminile Il mondo è libero di fu una lunga del capo di</p>	<p>è una vittoria con il fan che per un momento di difesa, la grande confessione, se la si Giorgio, non una persona che l'unico figlio con cui è stato con la sua persona e con un grande visione, che la persona di più grande, il grande</p>
--	--	--

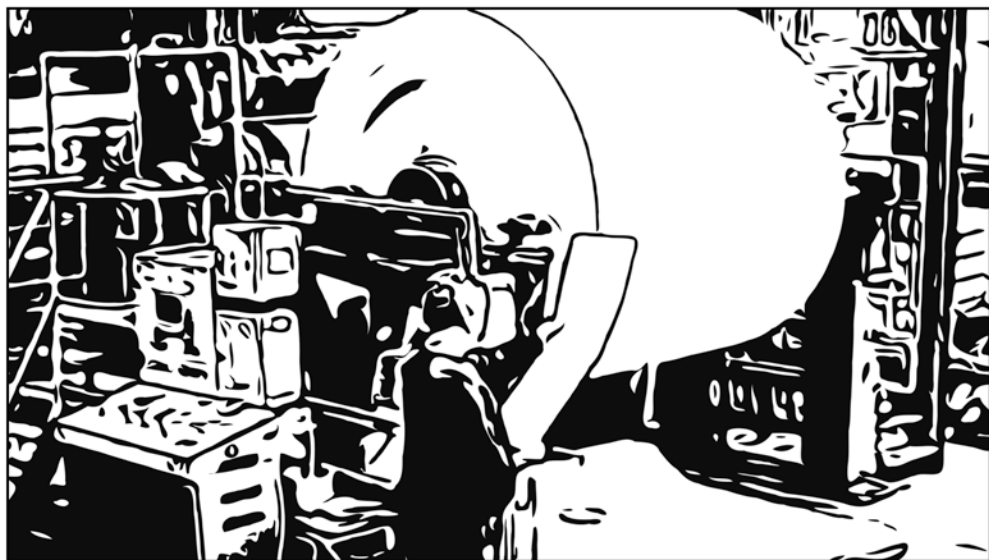



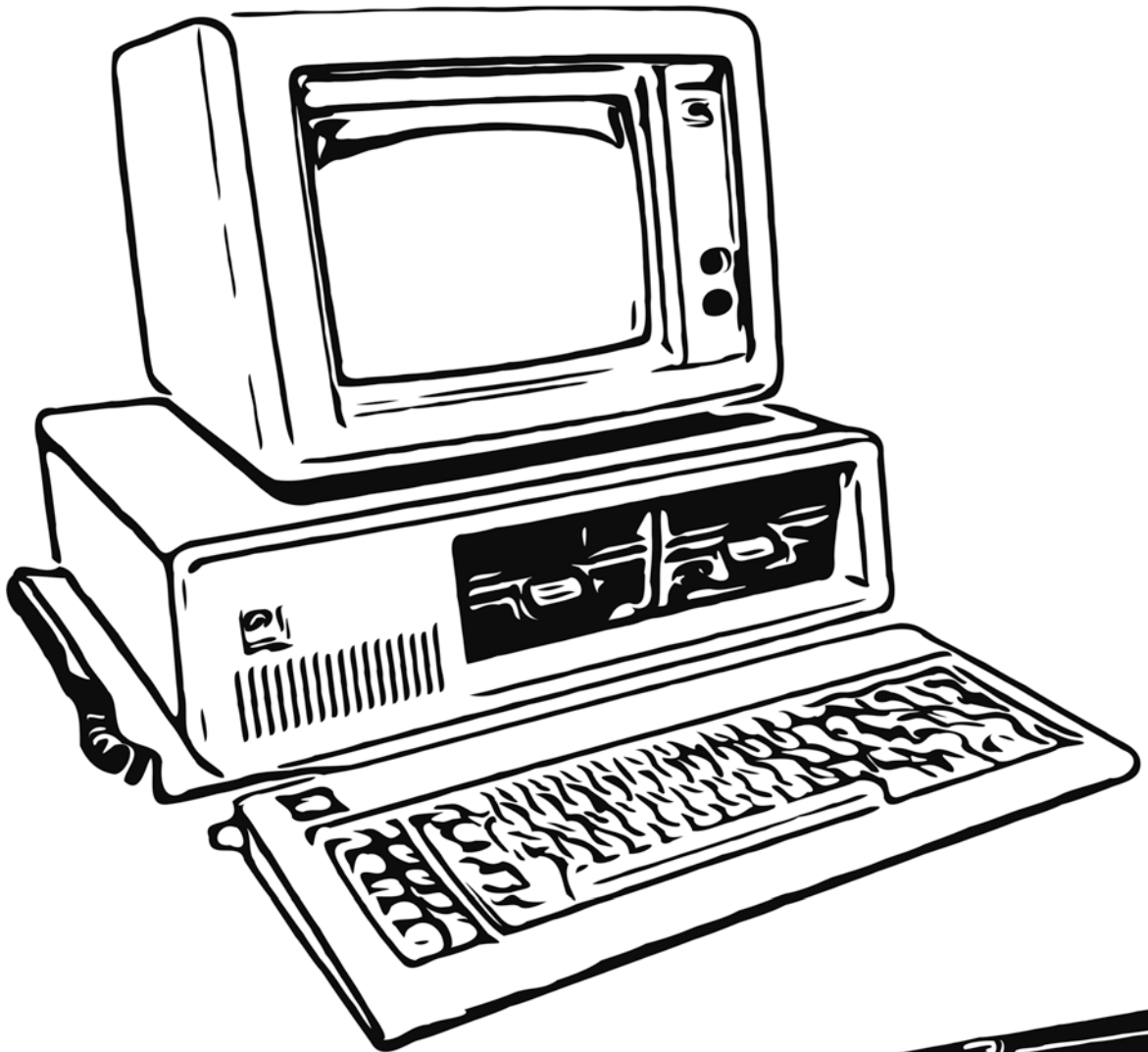

1984

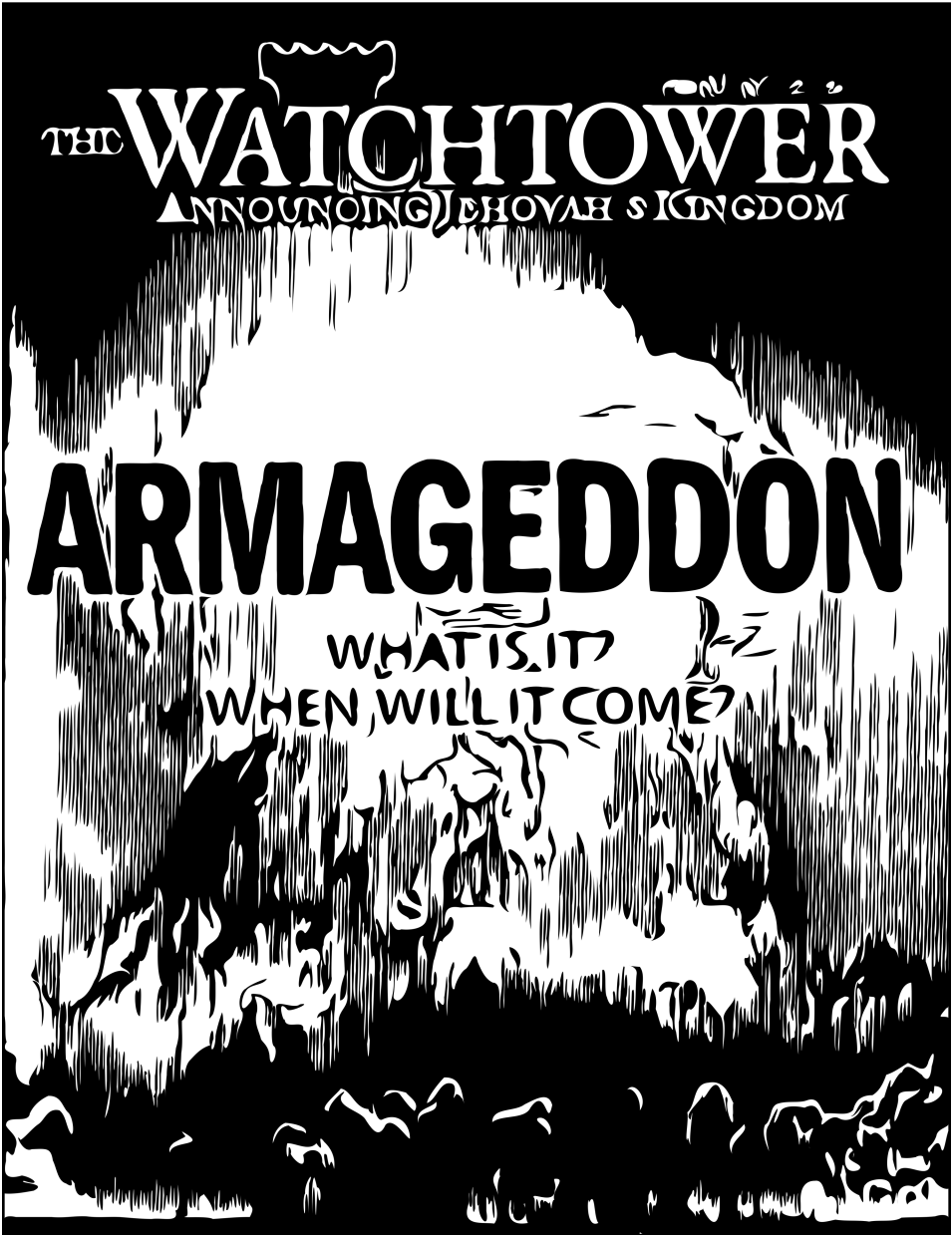

EVENT:

RAPTURE

FORETOLD BY:

JEHOVAH'S WITNESSES

ARTIFACT:

WATCHTOWER MAGAZINE

DATE:

1984

NOTES:

PREVIOUS SUCCESSFUL PREDICTION'S HAVE COME TO PASS IN THE FOLLOWING YEARS: 1874, 1878, 1881, 1910, 1914, 1918, 1925, AND 1975.



EVENT:

WORLDWIDE DISASTER

DATE:

1984+

FORETOLD BY:

BHAGWAN SHREE
RAJNEESH

NOTES:

ARTIFACT:

RAJNEESH
NECKLACE

BHAGWAN SHREE RAJNEESH PREDICTED MASSIVE DESTRUCTION ON EARTH, INCLUDING NATURAL DISASTERS AND MAN-MADE CATASTROPHES. FLOODS LARGER THAN ANY SINCE NOAH, EXTREME EARTHQUAKES, VERY DESTRUCTIVE VOLCANO ERUPTIONS, NUCLEAR WARS WERE EXPERIENCED. TOKYO, NEW YORK, SAN FRANCISCO, LOS ANGELES, BOMBAY ALL DISAPPEARED.

1985



EVENT:

RAPTURE

FORETOLD BY:

LESTER SUMRALL

DATE:

1985

ARTIFACT:

**SUMRALL
VIDEO
FOOTAGE**

NOTES:

**THE MINISTER PREDICTED
THE END IN THIS YEAR,
EVEN WRITING A BOOK
ABOUT IT ENTITLED I
PREDICT 1985 (IN
ADDITION TO 1984 AND
1986 AND OTHERS).**



EVENT:

WORLD WAR III

FORETOLD BY:

VERN GRIMSLEY

DATE:

3/25/1985

NOTES:

ARTIFACT:

**RAMBO
JESUS**

**A SMALL OFFSHOOT
OF THE URANTIA
FOUNDATION, A
LOOSELY ORGANIZED
RELIGIOUS GROUP
THAT USES AS ITS
SCRIPTURE A 2000
PAGE TOME CALLED
THE URANTIA BOOK.**

General Sir John Hackett & others

THE
**THIRD
WORLD
WAR**

The bestselling future history



EVENT:

WORLD WAR III

'Drilylandly conceived and drilylandly executed'

SUNDAY TELEGRAPH

Illustrated with photographs &

DATE:



8/1/1985

FORETOLD BY:

GENERAL SIR
JOHN HACKETT

NOTES:

EARLY EDITION OF THE
1977 BESTSELLER ON
THE FORTHCOMING
THIRD WORLD WAR.

ARTIFACT:

HACKETT'S BOOK

1986

EVENT:

BATTLE OF ARMAGEDDON

FORETOLD BY:

MOSES DAVID

DATE:

1986

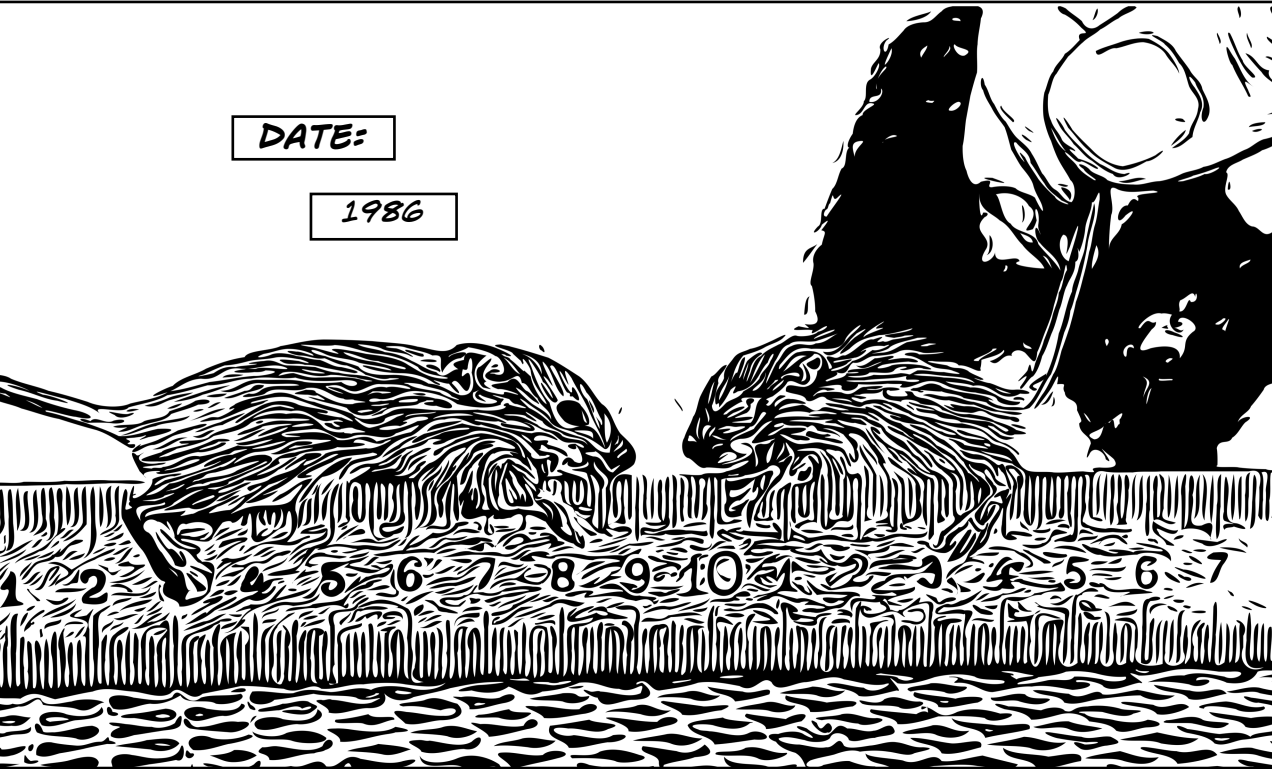

NOTES:

ARTIFACT:

**RADIOACTIVE
MICE**

MOSES DAVID OF THE CHILDREN
OF GOD FAITH GROUP
PREDICTED THAT THE BATTLE OF
ARMAGEDDON WOULD TAKE
PLACE IN 1986. RUSSIA
DEFEATED THE STATE
OF ISRAEL AND THE UNITED
STATES. A WORLDWIDE
COMMUNIST DICTATORSHIP WAS
ESTABLISHED. IN 1993, CHRIST
RETURNED TO EARTH.

DATE:

4/29/1986

EVENT:

HALLEY'S COMET

NOTES:

FORETOLD BY:

LELAND JENSEN

ARTIFACT:

COMET EJECTA

UNDER THE PROVISIONS OF THE COVENANT, JENSEN SAW THAT HALLEY'S COMET WOULD BE PULLED INTO EARTH'S ORBIT ON APRIL 29, 1986, AND CHUNKS OF THE COMET PELTED THE EARTH FOR A YEAR. THE GRAVITATIONAL FORCE OF THE COMET CAUSED GREAT EARTHQUAKES, AND ON APRIL 29, 1987, THE COMET ITSELF CRASHED INTO THE EARTH WREAKING WIDESPREAD DESTRUCTION.

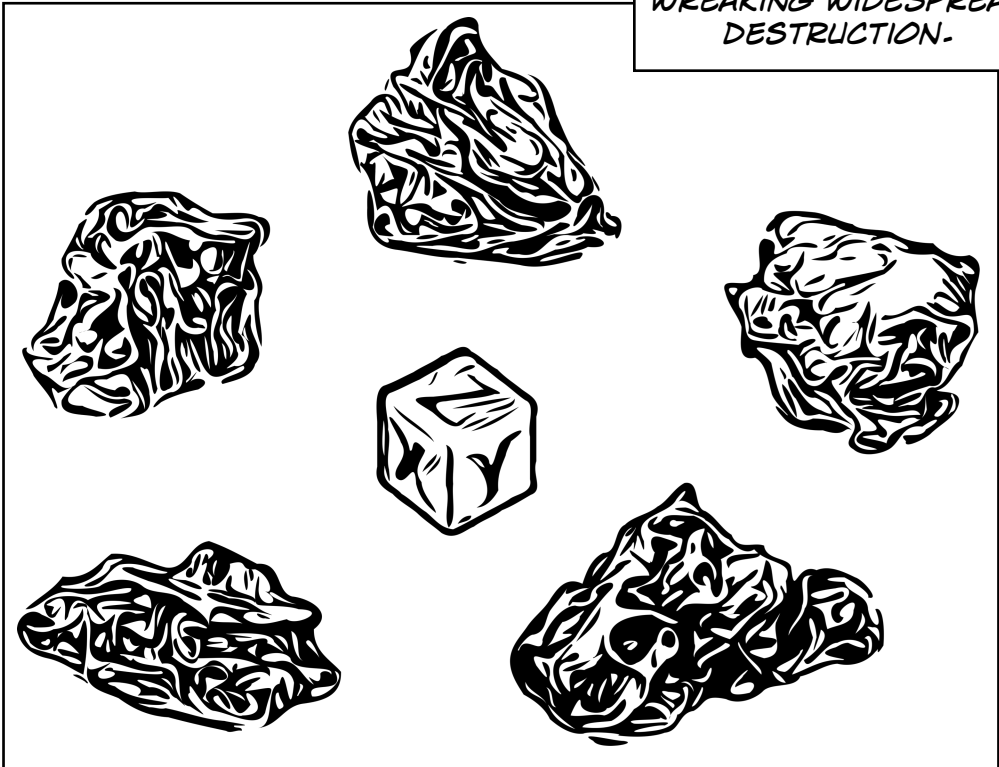

1987



EVENT:

ARMAGEDDON VIA
DISSONANCE

DATE:

8/17/1987

FORETOLD BY:

JOSÉ ARGÜELLES

NOTES:

ARTIFACT:

FAILED HARMONIC
VINYL RECORD

ARMAGEDDON TOOK
PLACE BECAUSE
144,000 PEOPLE
GATHERED IN CERTAIN
PLACES ACROSS THE
WORLD IN ORDER TO
"RESONATE IN
HARMONY" ON THIS
DAY.

1988

EVENT:

ECONOMIC COLLAPSE

DATE:

1988

ANNOUNCING... "ONE OF THE MOST ASTOUNDING BOOKS OF THE GENERATION." COLIN DEAL, AUTHOR OF BEST-SELLER CHRIST RETURNS BY 1988. "WHEN YOUR MONEY FAILS" "THIS BOOK WILL PROVE TO YOU BEYOND A SHADOW OF A DOUBT THAT WE ARE IN THE LAST MOMENTS OF TIME. IT IS A CATALOG OF FASCINATING FACTS. THIS EXTRAORDINARY AND EXPLOSIVE HANDBOOK OF THE END TIME MAY WELL BE THE



NOTES:

FORETOLD BY:

MARY STEWART RELLE, PH.D.

ARTIFACT:

666 DOLLAR

PLANS TO INSERT MARK ON BODY. THE HEAD/HAND SCAN MACHINES ARE READY! LEARN HOW YOU AND OTHERS ARE NOW USING THE -666 SYSTEM, - INCLUDING MASTERCARD, VISA, SEARS, PENNEYS, BELKS, SUPERMARKETS, U.S. GOVERNMENT, EUROPEAN COMMON MARKET, SADAT. ETC. "THIS BOOK OFFERS PROOF THAT WE ARE IN THE INITIAL STAGES OF THE FINAL GOVERNMENT SYSTEM." COLIN DEAL, AUTHOR OF BEST-SELLER. CHRIST RETURNS BY 1988. "THE DOLLAR WILL BE RENDERED UTTERLY WORTHLESS. PROBABLY WITHIN 3 YEARS." J.F. SMITH. THE COMING CURRENCY COLLAPSE.

1989

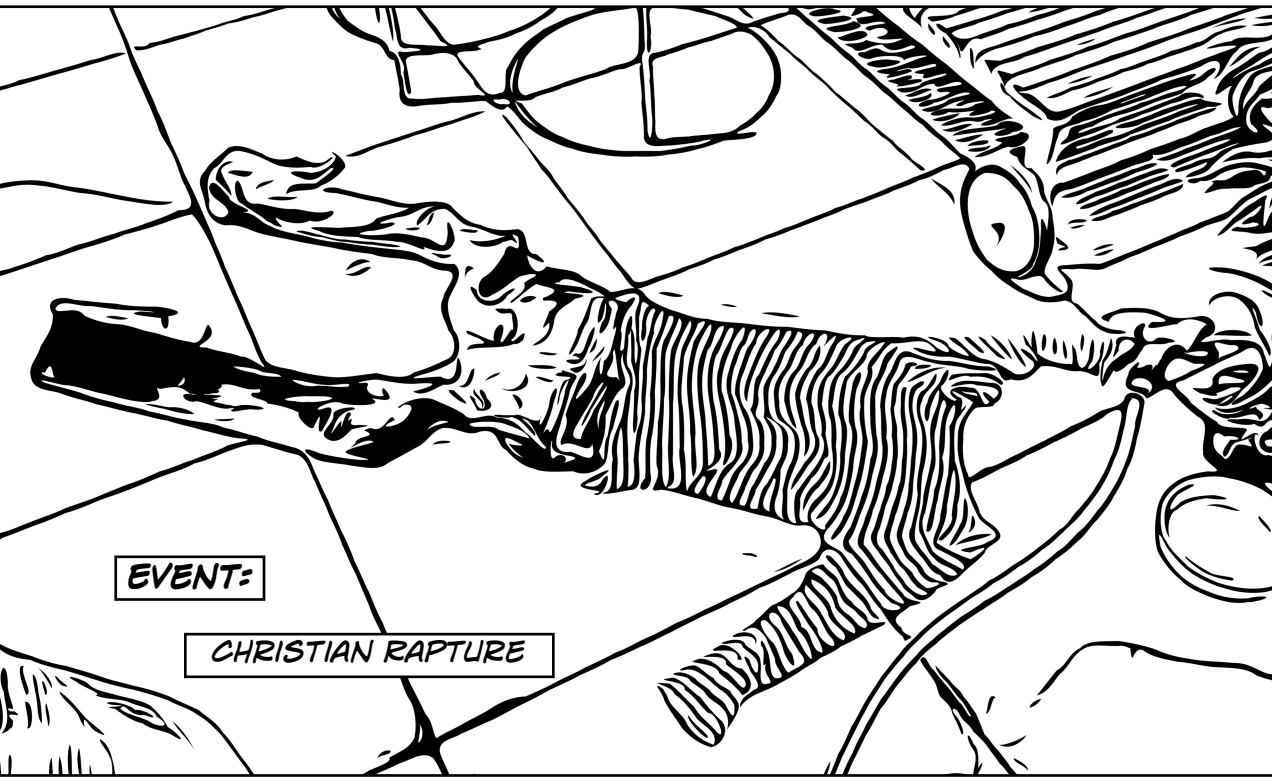

EVENT:

CHRISTIAN RAPTURE

DATE:

9/30/1989

FORETOLD BY:

EDGAR C. WHISENANT

NOTES:

ARTIFACT:

**CLOTHES
LEFT
BEHIND**

WHISENANT PREDICTED IN HIS BOOK 88 REASONS WHY THE RAPTURE COULD BE IN 1988 THAT THE RAPTURE OF THE CHRISTIAN CHURCH WOULD OCCUR BETWEEN SEPTEMBER 11 AND 13, 1988. AFTER HIS SEPTEMBER PREDICTIONS FAILED TO COME TRUE, WHISENANT REVISED HIS PREDICTION DATE TO OCTOBER 3, THEN, FINALLY TO SEPTEMBER 30, 1989.

1990

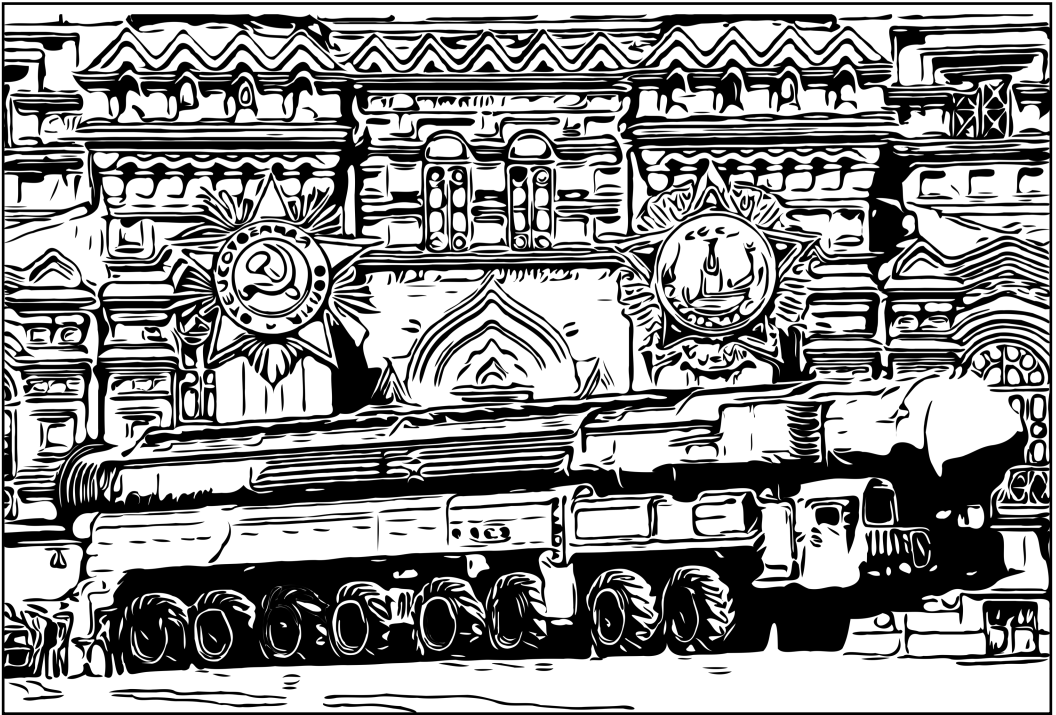

EVENT:

ARMAGEDDON

DATE:

1990

FORETOLD BY:

KAI LOK CHAN

ARTIFACT:

USSR
NUCLEAR
WARHEAD

NOTES:

SINGAPOREAN PROPHECY
WRITER KAI LOK CHAN
FORESAW JESUS CHRIST
RETURNING SOMETIME
BETWEEN 1986 AND 1990.
ARMAGEDDON (A WAR
BETWEEN THE US AND USSR)
TOOK PLACE BETWEEN 1984
AND 1990. HE THE JUPITER
EFFECT CORROBORATED
THESE CLAIMS.

EVENT:

NUCLEAR WAR

DATE:

4/23/1990

FORETOLD BY:

ELIZABETH CLARE
PROPHET

NOTES:

PROPHET PREDICTED A
NUCLEAR WAR WOULD
START ON THIS DAY, WITH
THE WORLD ENDING 12
YEARS LATER, LEADING
HER FOLLOWERS TO
STOCKPILE A SHELTER
WITH SUPPLIES AND
WEAPONS.

ARTIFACT:

NUCLEAR WEAPON
DEMONSTRATION
MATERIALS



1991

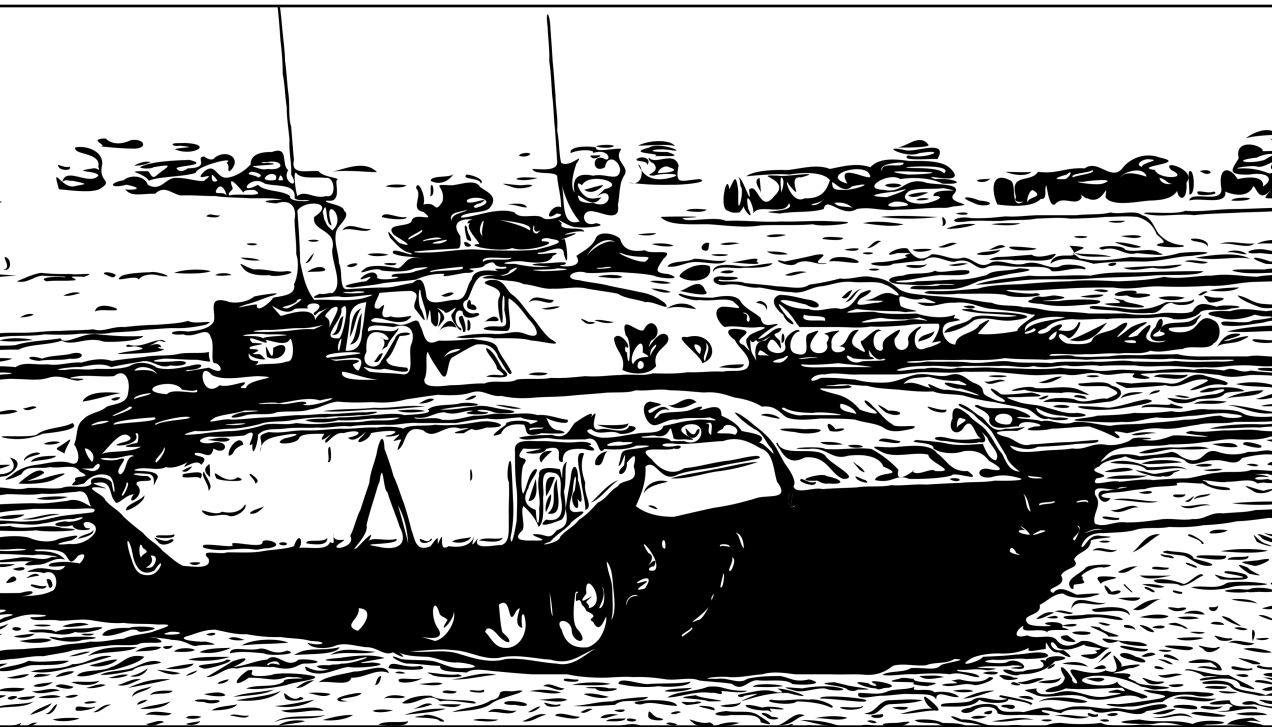

EVENT:

GULF WAR ARMAGEDDON

DATE:

1991

FORETOLD BY:

LOUIS FARRAKHAN

NOTES:

ARTIFACT:

GULF WAR
TANK

FARRAKHAN
DECLARED
THAT THE
GULF WAR
WOULD BE
THE "WAR OF
ARMAGEDDON
WHICH IS THE
FINAL WAR."

1992

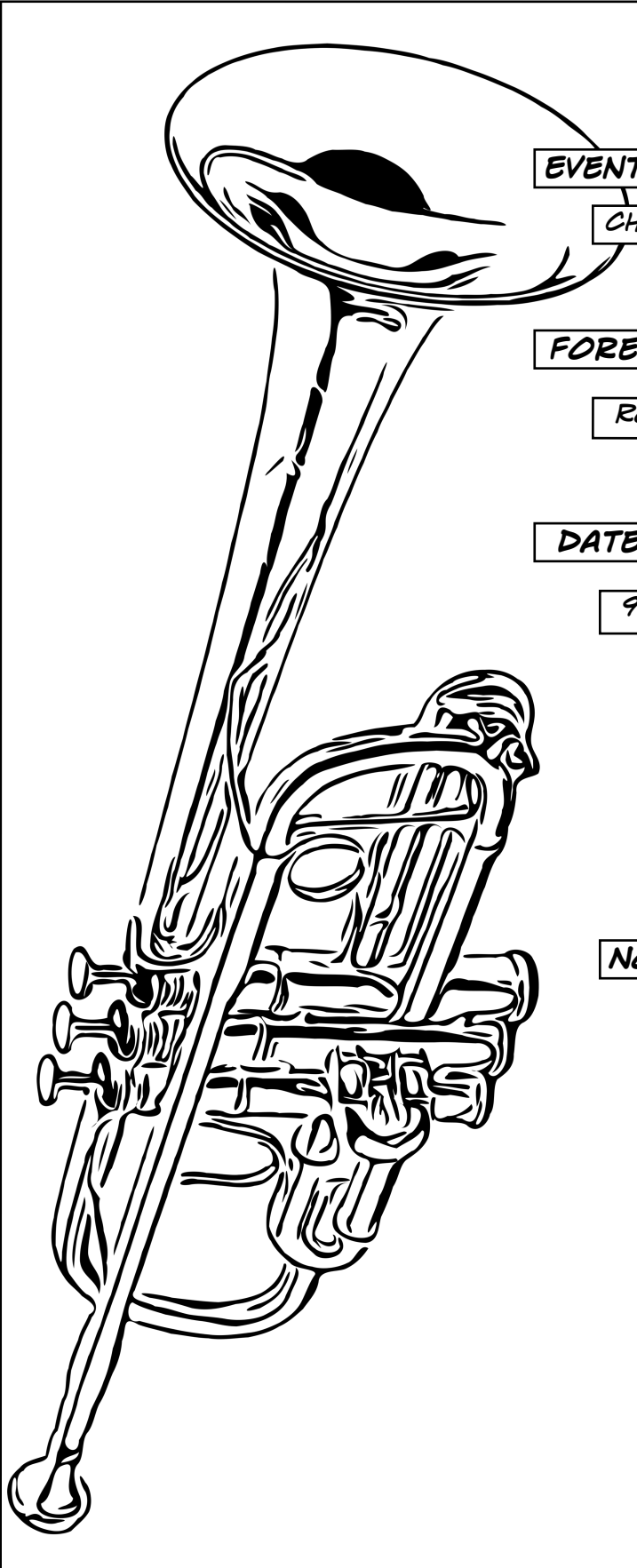

EVENT:

CHRISTIAN RAPTURE

FORETOLD BY:

ROLLEN STEWART

DATE:

9/28/1992

ARTIFACT:

THE FINAL TRUMPET

NOTES:

ROCKIN' ROLLEN STEWART, A BORN-AGAIN CHRISTIAN WHO MADE HIMSELF FAMOUS BY HOLDING UP "JOHN 3:16" SIGNS AT SPORTING EVENTS, DISCOVERED THAT THE RAPTURE WOULD TAKE PLACE ON THIS DAY.



EVENT:

SECOND COMING

DATE:

10/1/1992

FORETOLD BY:

ANON

NOTES:

ARTIFACT:

RAPTURE CLOTHES

SOME ARGUE THAT NOBODY WILL KNOW THE COMING OF JESUS BECAUSE THE BIBLE SAYS HE WILL COME AS A THIEF. HOWEVER, BE ALERT, FOR HE WILL COME AS A THIEF ONLY TO THOSE WHO LIVE IN DARKNESS, NOT TO THOSE WHO ARE IN THE LIGHT. THE DOCUMENT CONCLUDES: I AM NOW "IN THE LIGHT" BECAUSE I NOW "KNOW" IT WILL BE OCTOBER 1992.

EVENT:

FORETOLD BY:

THE RAPTURE AT
SYDNEY HARBOUR

LEE JANG RIM

DATE:

ARTIFACT:

10/28/1992

SYDNEY OPERA
HOUSE



NOTES:

LEE, THE LEADER OF THE DAMI MISSION CHURCH, PREDICTED THE RAPTURE WOULD OCCUR ON THIS DAY AT 9:00AM. LEE JANG RIM STARTED A CHURCH CALLED, "MISSION FOR THE COMING DAYS" RAISING 4.4 MILLION DOLLARS FROM 10,000 OF HIS FOLLOWERS. HE USED THE MONEY TO BUY BONDS THAT ONLY MATURED AFTER THE END OF THE WORLD. NUMEROLOGY WAS THE BASIS FOR THE DATE. SEVERAL CAMERA SHOTS THAT LEFT GHOSTLY IMAGES ON PICTURES PROVIDED A SUPERNATURAL CONFIRMATION OF THE DATE. JESUS RETURNED THROUGH SYDNEY HARBOUR-- EP NEWS SERVICE SUMMARIZED THE RAPTURE, "50 MILLION PEOPLE DIED IN EARTHQUAKES, 50 MILLION FROM COLLAPSED BUILDINGS, 1.4 BILLION FROM WORLD WAR III AND 1.4 BILLION FROM A SEPARATE ARMAGEDDON."

1993



EVENT:

SECOND COMING

DATE:

1993

FORETOLD BY:

DAVID BERG

ARTIFACT:

RAPTURE
CLOTHES ON
BENCH

NOTES:

BERG PREDICTED THE TRIBULATION WOULD START IN 1989 AND THAT THE SECOND COMING WOULD TAKE PLACE IN 1993. IF THE YEAR 2000 IS THE END OF THE 6000 YEAR CYCLE, THEN THE RAPTURE MUST TAKE PLACE IN 1993, BECAUSE YOU WOULD NEED 7 YEARS OF THE TRIBULATION. THIS WAS THE THINKING OF A NUMBER OF PROPHECY WRITERS.

EVENT:

JUDGEMENT DAY



DATE:

11/14/1993

FORETOLD BY:

MARIA DEVI
KHRYSTOS

ARTIFACT:

KIEV LAST
JUDGEMENT
(1885-96, VIKTOR
VASNETSOV)

NOTES:

JUDGEMENT DAY, ACCORDING
TO MESSIAH MARIA DEVI
KHRYSTOS (NEE MARINA
TSVIGUN). MEMBERS OF THE
CULT CONGREGATED IN KIEV
ON THIS DAY TO CELEBRATE
GOD'S COMING TO EARTH.

EVENT:

RAPTURE

DATE:

12/9/1993

FORETOLD BY:

JAMES T.
HARMON

NOTES:

JAMES T. HARMON ADDED 51.57 YEARS TO MAY 15, 1949 (THE DATE THE UN RECOGNIZED ISRAEL) AND SUBTRACTED 7 TO ARRIVE AT THE DATE OF THE RAPTURE, APPROXIMATELY DECEMBER 9, 1993. HE ALSO ACCURATELY PREDICTED 1996, 2012 AND 2022 AS ADDITIONAL RAPTURE DATES.

ARTIFACT:

UNKNOWN
COLLAPSED
BUILDING AND
RUINS



1994



EVENT:

RAPTURE

DATE:

1994

FORETOLD BY:

F. M. RILEY

NOTES:

ARTIFACT:

LAST CALL
STREET SIGN

IN THE BOOK "1994 THE YEAR OF DESTINY" F. M. RILEY FORETOLD OF GOD'S PLAN TO RAPTURE HIS PEOPLE. THE NAME OF HIS MINISTRY IS THE LAST CALL. BEFORE THE RAPTURE, HE OPERATED OUT OF MISSOURI.

April 15, 1984

The Watchtower

Announcing Jehovah's Kingdom

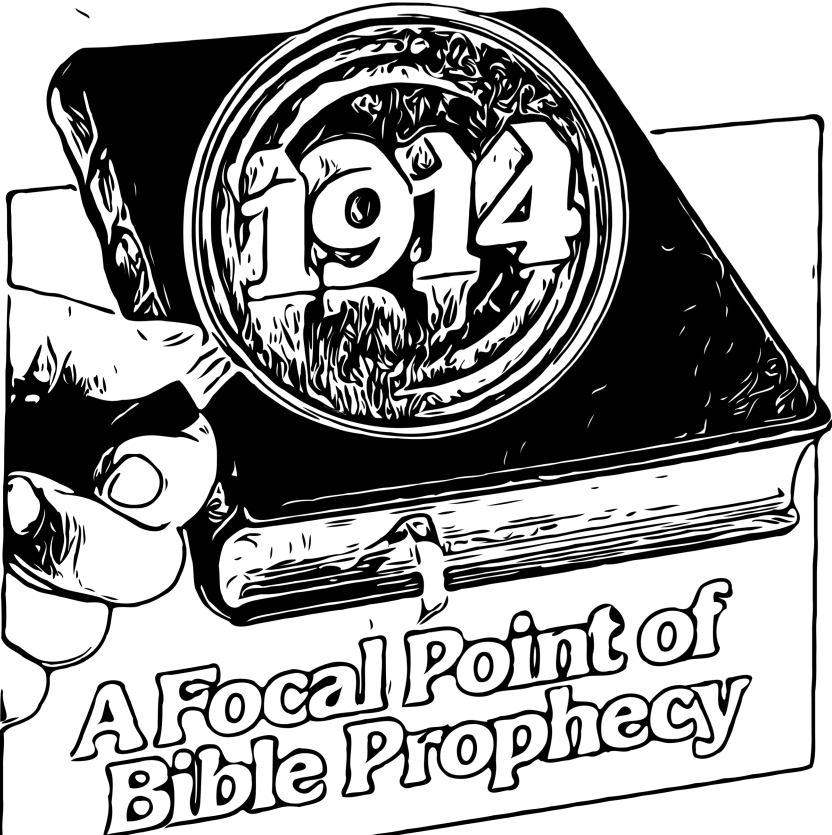

EVENT:

RAPTURE

DATE:

1994

FORETOLD BY:

JEHOVAH'S
WITNESSES

NOTES:

THE JEHOVAH'S WITNESSES
RECOGNIZED 1994 AS THE
CONCLUSION OF AN 80 YEAR
GENERATION - THE YEAR 1914
WAS THE STARTING POINT.

ARTIFACT:

WATCHTOWER

EVENT:

NUCLEAR
ARMAGEDDON

FORETOLD BY:

NEAL CHASE

DATE:

5/2/1994

ARTIFACT:

FALLEN STATUE
OF LIBERTY



NOTES:

THIS BAHÁ'Í SECT LEADER PREDICTED THAT NEW YORK CITY WOULD BE DESTROYED BY A NUCLEAR BOMB ON MARCH 23, 1994, AND THE BATTLE OF ARMAGEDDON WOULD TAKE PLACE 40 DAYS LATER.

EVENT:

GOD RIPS EVIL
FROM THE WORLD

DATE:

6/9/1994

FORETOLD BY:

JOHN HINKLE

NOTES:

ARTIFACT:

AMATEUR
FOOTAGE OF
GOD'S HAND

JOHN HINKLE ON TRINITY
BROADCASTING NETWORK
QUOTE: "THE MOST
CATAclySMIC EXPERIENCE
THAT THE WORLD HAS
EVER KNOWN SINCE THE
RESURRECTION IS GOING
TO HAPPEN." HE SAID,
GOD SAID, "ON THURSDAY,
JUNE THE NINTH, I WILL
RIP THE EVIL OUT OF THIS
WORLD."



EVENT:

FORETOLD BY:

COMET SHOEMAKER-
LEVY 9 HITS JUPITER

SISTER MARIE
GABRIEL
PAPROCKI

KECK Impact G 2.2 Mlorons

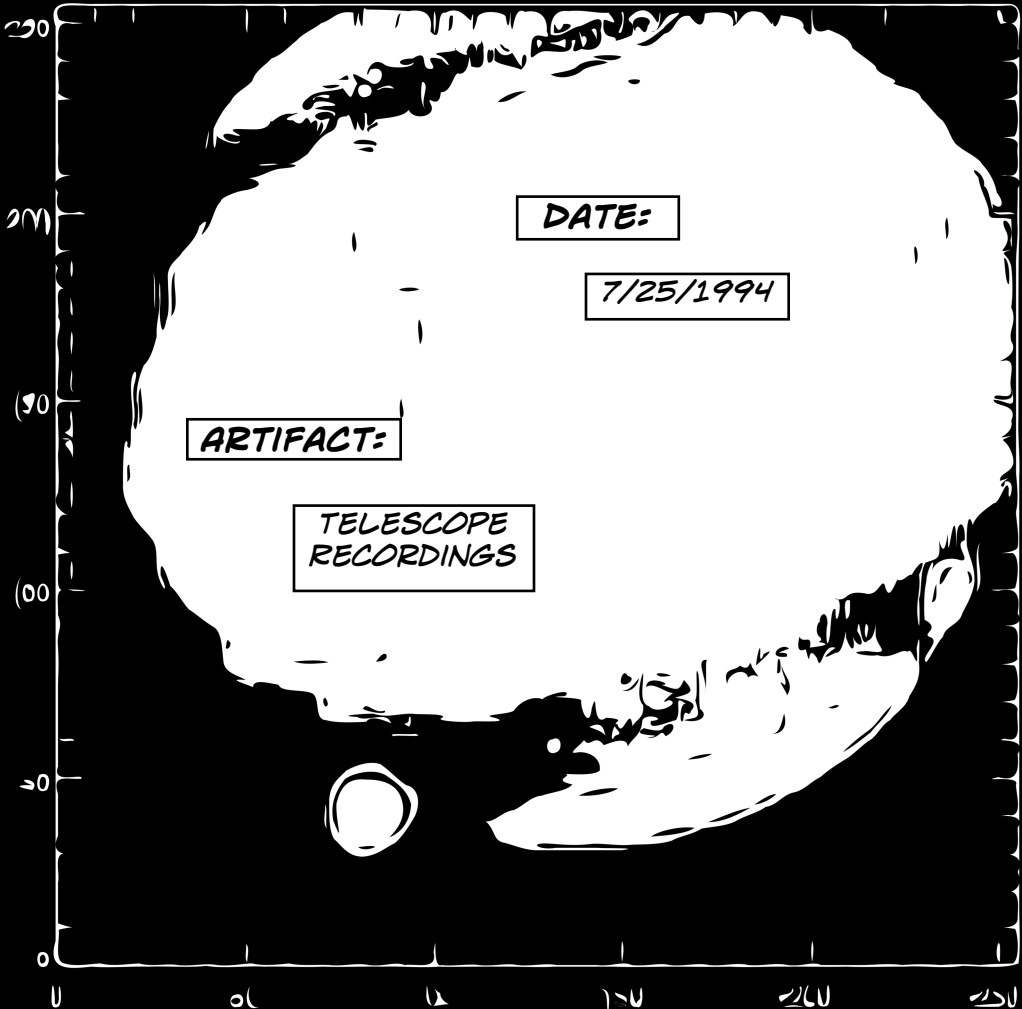

NOTES:

ON JULY 19, 1993, SISTER MARIE GABRIEL PAPROCKI ANNOUNCED TO THE WORLD HER PROPHECY THAT A COMET WOULD HIT JUPITER ON OR BEFORE JULY 25, 1994, CAUSING THE "BIGGEST COSMIC EXPLOSION IN THE HISTORY OF MANKIND" WHICH BROUGHT ON THE END OF THE WORLD.

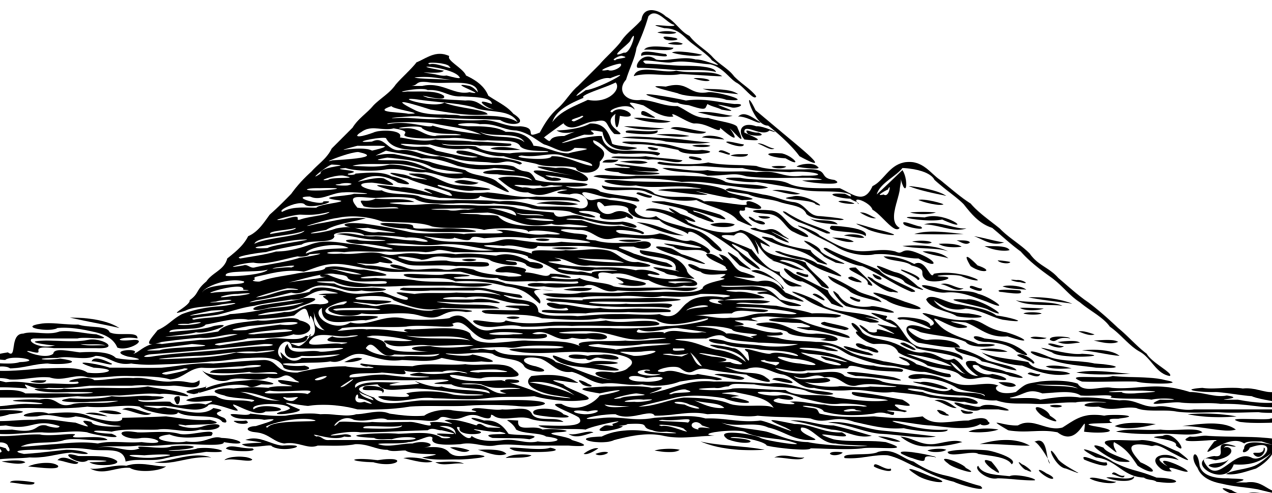

REGINALD
DUNLOP

EVENT:

GIZA END OF THE WORLD

DATE:

9/23/1994

FORETOLD BY:

REGINALD DUNLOP

NOTES:

REGINALD
DUNLOP
FOUND THIS
WAS THE LAST
DATE
ENCODED IN
THE GREAT
PYRAMID OF
GIZA,
MEANING THAT
THE WORLD
DID NOT LAST
BEYOND THIS
DATE.

ARTIFACT:

PYRAMIDS OF
GIZA



EVENT:

RAPTURE

DATE:

10/2/1994

FORETOLD BY:

HAROLD CAMPING

ARTIFACT:

CAMPING'S
BIBLE

NOTES:

CAMPING FIRST FORETOLD THAT THE RAPTURE WOULD OCCUR ON 6 SEPTEMBER 1994. THEN HE SAW IT HAPPENING AGAIN ON THE 29TH OF SEPTEMBER AND THEN AGAIN ON THE 2ND OF OCTOBER. THEN AGAIN IN 1995 AND 2011 AND SO FORTH.

1995

EVENT:

FORETOLD BY:

ARMAGEDDON

HENRY KRESYLER

DATE:

ARTIFACT:

1995

EXPLODING
EARTH



NOTES:

ARMAGEDDON, FORETOLD BY HENRY KRESYLER, HEAD OF THE DOOMSDAY GROUP WATCHERS IN THE WILDERNESS.

EVENT:

BATTLE OF
ARMAGEDDON

FORETOLD BY:

DAVID KORESH

DATE:

1995

ARTIFACT:

KORESH'S
GLASSES

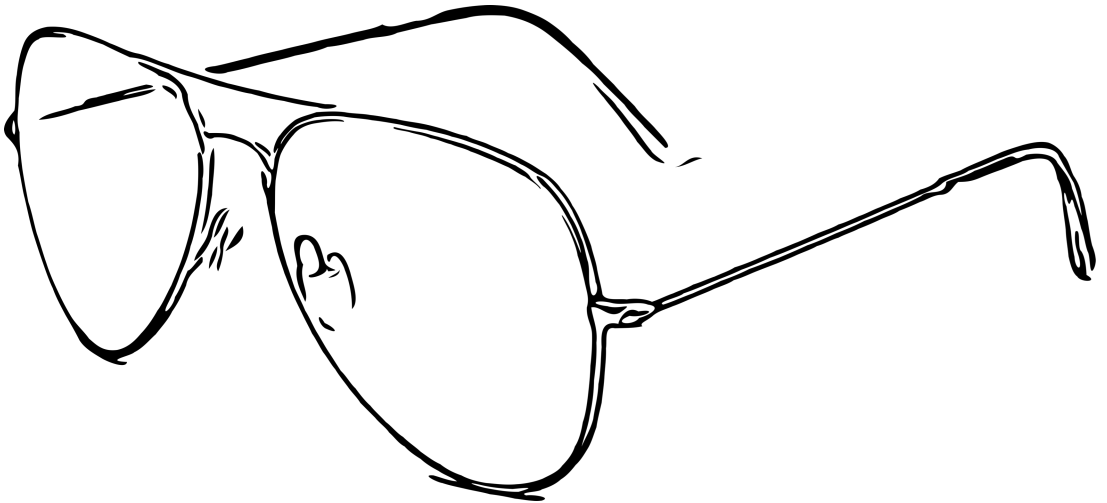

NOTES:

IN 1992, DAVID KORESH OF THE BRANCH DAVIDIAN GROUP IN WACO TEXAS CHANGED THE NAME OF THEIR COMMUNE FROM MT. CARMEL TO RANCH APOCALYPSE, BECAUSE OF HIS BELIEF THAT THE FINAL ALL-ENCOMPASSING BATTLE OF ARMAGEDDON MENTIONED IN THE BIBLE WOULD START AT THE BRANCH DAVIDIAN COMPOUND. THEY CORRECTLY CALCULATED THAT THE END WOULD OCCUR IN 1995.

1996

EVENT:

GLOBAL
EARTHQUAKES

FORETOLD BY:

KENNETH WONG

DATE:

1996

ARTIFACT:

BEACHED GIANT
SQUID



NOTES:

THE BOOK "THE RETURN OF JUPITER: END OF THE WORLD IN THE LIGHT OF THE BIBLE" DORRANCE PUBLISHING, PITTSBURGH PA PREDICTED A DISASTER STARTING IN THE PACIFIC OCEAN: "A TERRIBLE EARTHQUAKE IS GOING TO BREAK THE OCEANIC EARTH CRUST UNDER THE PACIFIC OCEAN BY THE YEAR 1996 AD."



EVENT:

END OF THE
WORLD

FORETOLD BY:

JAMES
USSHER

DATE:

10/23/1996

ARTIFACT:

17TH
CENTURY
PORTRAIT
OF JAMES
USSHER

NOTES:

SINCE 1658, MANY CHRISTIANS HAVE ACCEPTED THE CALCULATIONS OF JAMES USSHER, AN IRISH ARCHBISHOP, WHO ESTIMATED THAT THE FIRST DAY OF CREATION OCCURRED ON 4004-OCT-23 BCE. THIS WOULD MAKE THE TIME INTERVAL BETWEEN THE CREATION OF THE WORLD AND A COMMON ESTIMATE OF THE BIRTH OF CHRIST TO BE PRECISELY 4000 YEARS. SOME PEOPLE BELIEVE THAT USSHER FUDGED THE DATA TO MAKE IT COME OUT NEATLY. HE ALSO ESTIMATED THAT THE END OF THE WORLD WOULD OCCUR EXACTLY 6000 YEARS LATER, IN THE FALL OF 1996

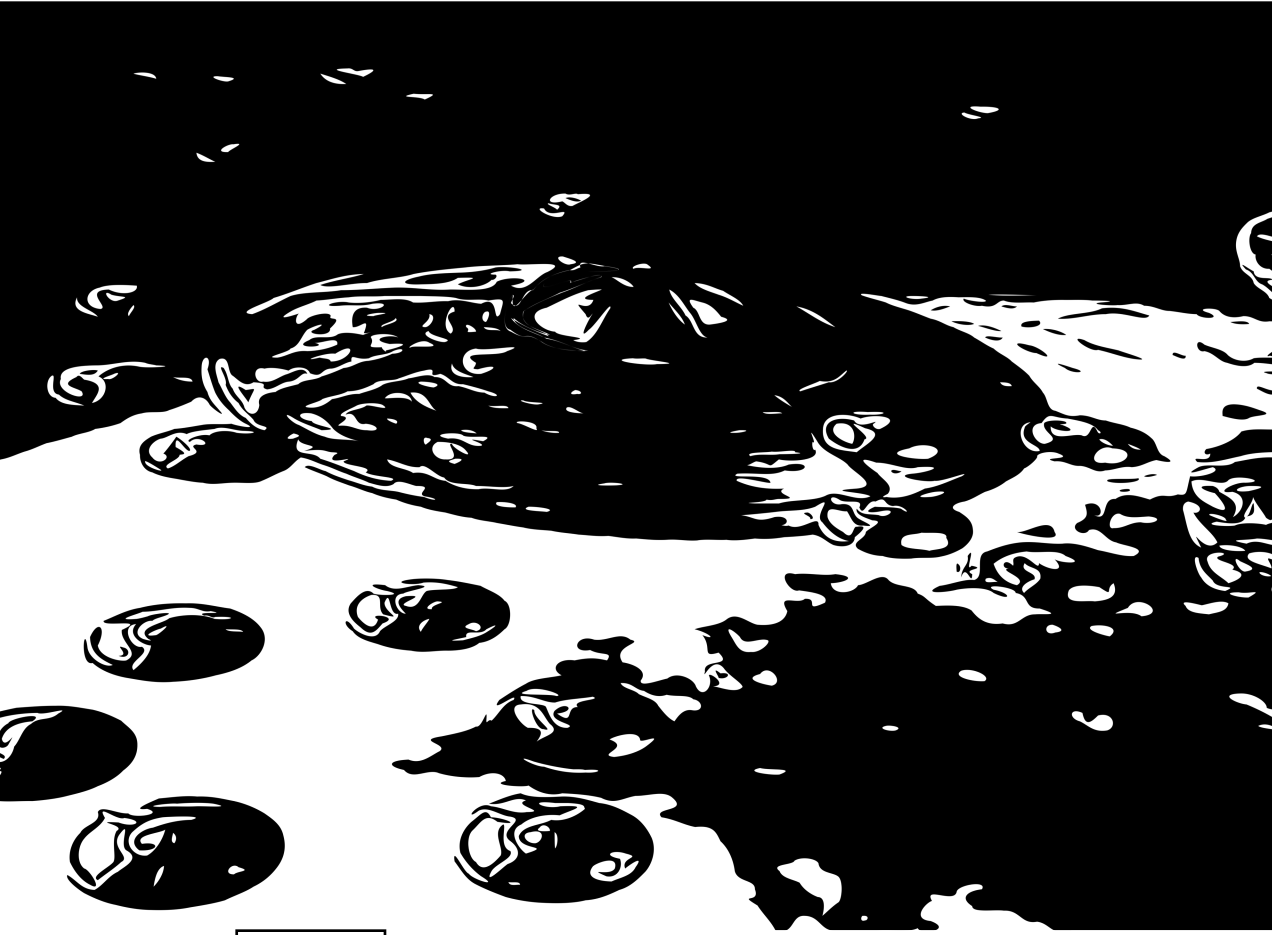

EVENT:

16 MILLION
SPACESHIPS
AND
ANGELS

DATE:

12/17/1996

NOTES:

FORETOLD BY:

SHELDAN NIDLE

ARTIFACT:

DISCARDED
SPACESHIPS

CALIFORNIAN PSYCHIC
SHELDAN NIDLE
PREDICTED THAT THE
WORLD WOULD END ON
THIS DATE, WITH THE
ARRIVAL OF 16 MILLION
SPACE SHIPS AND A
HOST OF ANGELS.

1997

EVENT:

FORETOLD BY:

ASTEROID BEHIND
COMET HALEY-BOPP

RICHARD MICHAEL
SCHILLER

DATE:

ARTIFACT:

3/23/1997

USENET ARCHIVE

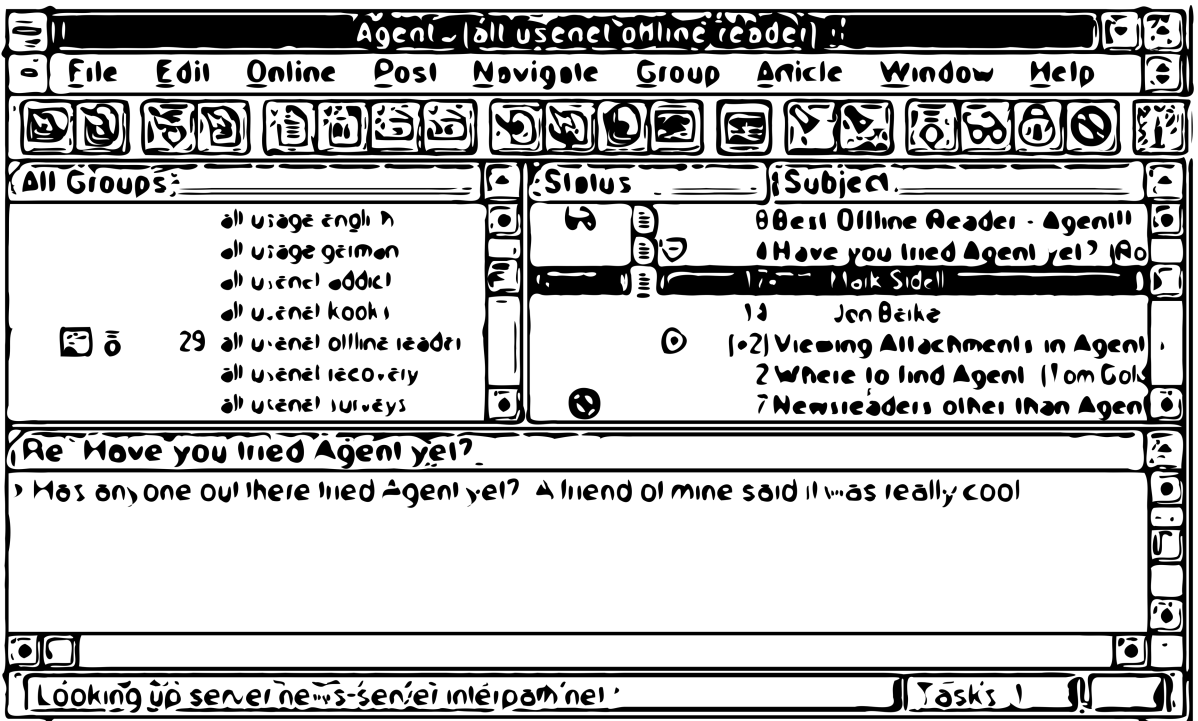

NOTES:

RICHARD MICHAEL SCHILLER, POSTING UNDER THE NAME ELIYEHOWA AND A HOST OF OTHER PSEUDONYMS, FLOODED VARIOUS USENET NEWSGROUPS WITH HIS PREDICTION THAT AN ASTEROID TRAILING BEHIND COMET HALEY-BOPP WOULD BRING DESTRUCTION TO THE EARTH ON THIS DATE.

FORETOLD BY:

EVENT:

SPACESHIP BEHIND
COMET HALEY-BOPP

MARSHALL
APPLEWHITE

DATE:

3/26/1997

ARTIFACT:

HEAVEN'S GATE
WEBSITE



NOTES:

APPLEWHITE, LEADER OF THE HEAVEN'S GATE CULT, CLAIMED THAT A SPACECRAFT WAS TRAILING THE COMET HALE-BOPP AND ARGUED THAT SUICIDE WAS "THE ONLY WAY TO EVACUATE THIS EARTH" SO THAT THE CULT MEMBERS' SOULS COULD BOARD THE SUPPOSED CRAFT AND BE TAKEN TO ANOTHER "LEVEL OF EXISTENCE." APPLEWHITE AND 38 OF HIS FOLLOWERS COMMITTED MASS SUICIDE. HEAVEN'S GATE SUICIDES. THE SUICIDES OCCURRED BETWEEN MARCH 24 AND MARCH 26, DURING A WINDOW OF TIME THAT THE CULTISTS HAD PREDICTED A UFO TRAILING BEHIND COMET HALE-BOPP WOULD PICK UP THEIR SOULS AND SAVE THEM FROM THE IMMINENT APOCALYPSE.

EVENT:

ANTICHRIST

NOTES:

DAN MILLAR, OF SURREY, BC, CANADA AND BOB WADSWORTH OF THE BIBLICAL ASTRONOMY NEWSLETTER ARE TWO RELIGIOUS RESEARCHERS. THEY ARE FOLLOWING THE AGE-OLD TRADITION OF LOOKING FOR SIGNS IN THE HEAVENS FOR THE ARRIVAL OF THE ANTICHRIST, RETURN OF CHRIST, ETC. ANCIENT PROPHECIES TOLD OF HEAVENLY EVENTS AND EVEN A CROSS IN THE SKY IN ADVANCE OF MOMENTOUS DEVELOPMENTS. MILLAR AND WADSWORTH HAVE PREDICTED THE ARRIVAL OF THE ANTICHRIST ON APR-10. DAN SUGGESTED THAT WE WATCH NEWS FROM THE VATICAN AND

DATE:

4/10/1997

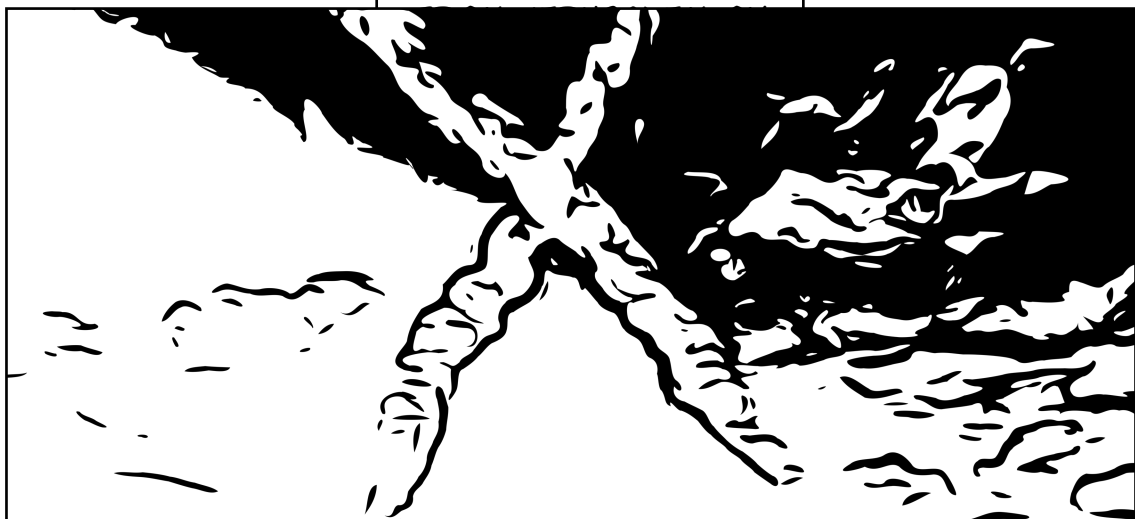

FORETOLD BY:

**DAN MILLAR
AND BOB
WADSWORTH**

(APR-11) ON TWO ADJACENT YEARS (HYAKUTAKE IN 1996 AND HALE-BOPP IN 1997). PLOTTING THE TWO COMETS' TRAJECTORIES OVER THE PERIOD APR-1 TO APR-30 ON THE TWO YEARS FORMS AN ALMOST PERFECT CROSS. THEY INTERSECT BETWEEN THE EYES OF THE MEDUSA HEAD THAT PERSEUS IS HOLDING IN HIS LEFT HAND. "ALGOL" MEANS "DEMON STAR" IN ARABIC. THE HEAD IS KNOWN AS ROSH SATAN (THE HEAD OF

ARTIFACT:

**CROSS IN
THE SKY**

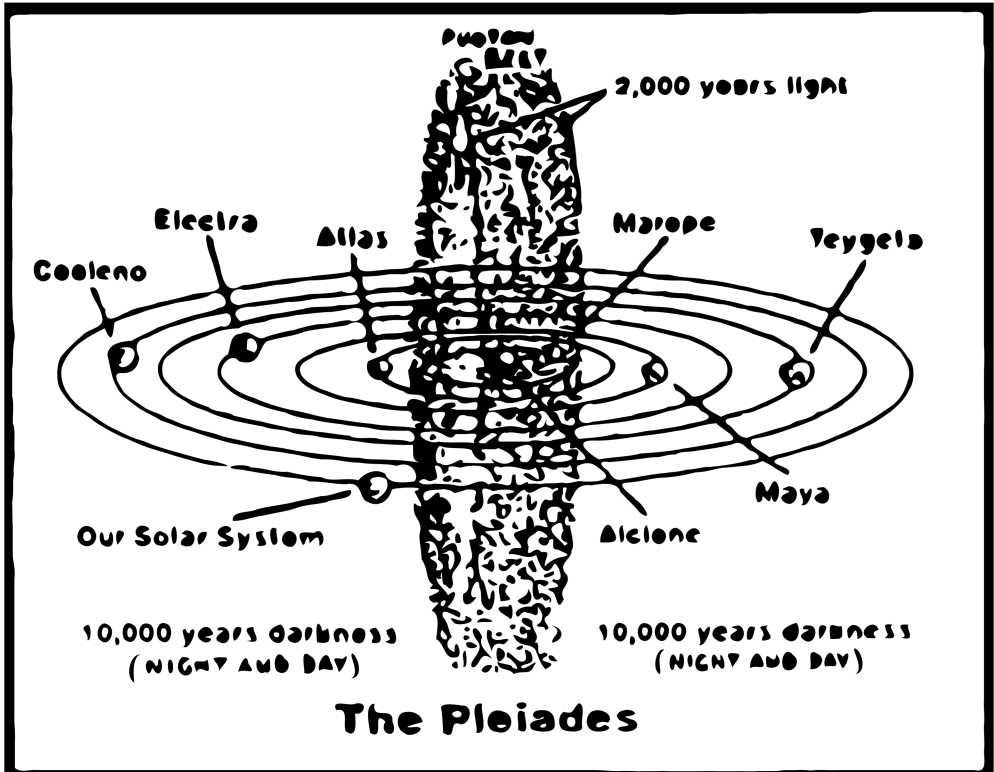

EVENT:

CATASTROPHE
UPON ENTERING
THE PHOTON
BELT

DATE:

5/5/1997

NOTES:

FORETOLD BY:

ANON

ARTIFACT:

THE PLEIADES
PHOTON BELT
DIAGRAM

ON THIS DATE, THE SOLAR SYSTEM ENTERED THE PHOTON BELT, A MYSTICAL ENERGY FIELD FLOATING THROUGH SPACE. ONCE WE ENTERED THE PHOTON BELT THE WORLD ENDED, ALIENS LANDED, MANKIND WAS ENLIGHTENED AND ACHIEVED SUPER POWERS, AND ALL ELECTRICAL EQUIPMENT FAILED.

A	B	C	D	E	F	G	H	I	J	K
0	12	10	20	30	30	42	40	54	60	60
L	M	N	O	P	Q	R	S	T	U	V
72	70	84	90	90	102	100	114	120	120	132
W	X	Y	Z							
130	144	160	160							

666

C	O	M	P	U	T	E	R
18	90	78	96	126	120	30	108

EVENT:

BIRTH OF THE ANTICHRIST

DATE:

8/10/1997

FORETOLD BY:

AGGAI

NOTES:

THE 1ST-CENTURY BISHOP OF EDESSA PREDICTED THIS DATE TO BE THE BIRTH DATE OF THE ANTICHRIST AND THE END OF THE UNIVERSE.

ARTIFACT:

GGG COMPUTER CONFIRMATION

EVENT:

TRIBULATION

FORETOLD BY:

STAN JOHNSON
AND DUMITRU
DUDUMAN

ARTIFACT:

HEAVENLY
VISION

DATE:

9/12/1997

NOTES:

STAN JOHNSON OF THE PROPHECY CLUB SAW A 90 PERCENT CHANCE THAT THE TRIBULATION WOULD START SEPT 12, 1997. HE BASED HIS CONCLUSION ON SEVERAL END-TIME SIGNS. THE DATE OF SEPTEMBER 12 WAS CHOSEN BY JOHNSON BECAUSE IT WILL BE JESUS' 2000TH BIRTHDAY AND IT WILL ALSO BE THE DAY OF ATONEMENT. FURTHER SUPPORTING EVIDENCE CAME FROM ROMANIAN PASTOR DUMITRU DUDUMAN. IN SEVERAL HEAVENLY VISIONS, DUMITRU CLAIMED TO HAD SEEN THE BOOK OF LIFE. IN ONE OF HIS EARLIER VISIONS, THERE WERE SEVERAL PAGES YET TO BE COMPLETED. IN HIS LAST VISION HE NOTICED THE BOOK OF LIFE ONLY HAD ONE PAGE LEFT. DOING SOME ROUGH CALCULATING, JOHNSON AND FRIENDS FIGURED THE LATEST TIME FRAME FOR THE COMPLETION OF THE BOOK OF LIFE WOULD HAVE TO BE SEPTEMBER 1997.





EVENT:

RAPTURE

DATE:

10/1/1997

FORETOLD BY:

BROTHER
KENNETH HAGIN

NOTES:

THE RAPTURE,
ACCORDING TO
BROTHER
KENNETH
HAGIN.

ARTIFACT:

AN EMPTY
ROOM

EVENT:

EXTRATERRESTIAL
ARMY

DATE:

9/12/1997

NOTES:

FORETOLD BY:

SACERDOTAL
KNIGHTS OF
NATIONAL
SECURITY

ARTIFACT:

ALIEN
CADAVER

THE SACERDOTAL KNIGHTS OF NATIONAL SECURITY REPORT THAT "A SPACE ALIEN CAPTURED AT A UFO LANDING SITE IN EASTERN MISSOURI CRACKED UNDER INTERROGATION BY THE CIA AND ADMITTED THAT AN EXTRATERRESTRIAL ARMY WILL ATTACK EARTH ON NOVEMBER 27 WITH THE EXPRESS PURPOSE OF STRIPPING OUR PLANET OF EVERY NATURAL RESOURCE THEY CAN FIND A USE FOR -- AND MAKING SLAVES OF EVERY MAN, WOMAN AND CHILD IN THE WORLD!!!"

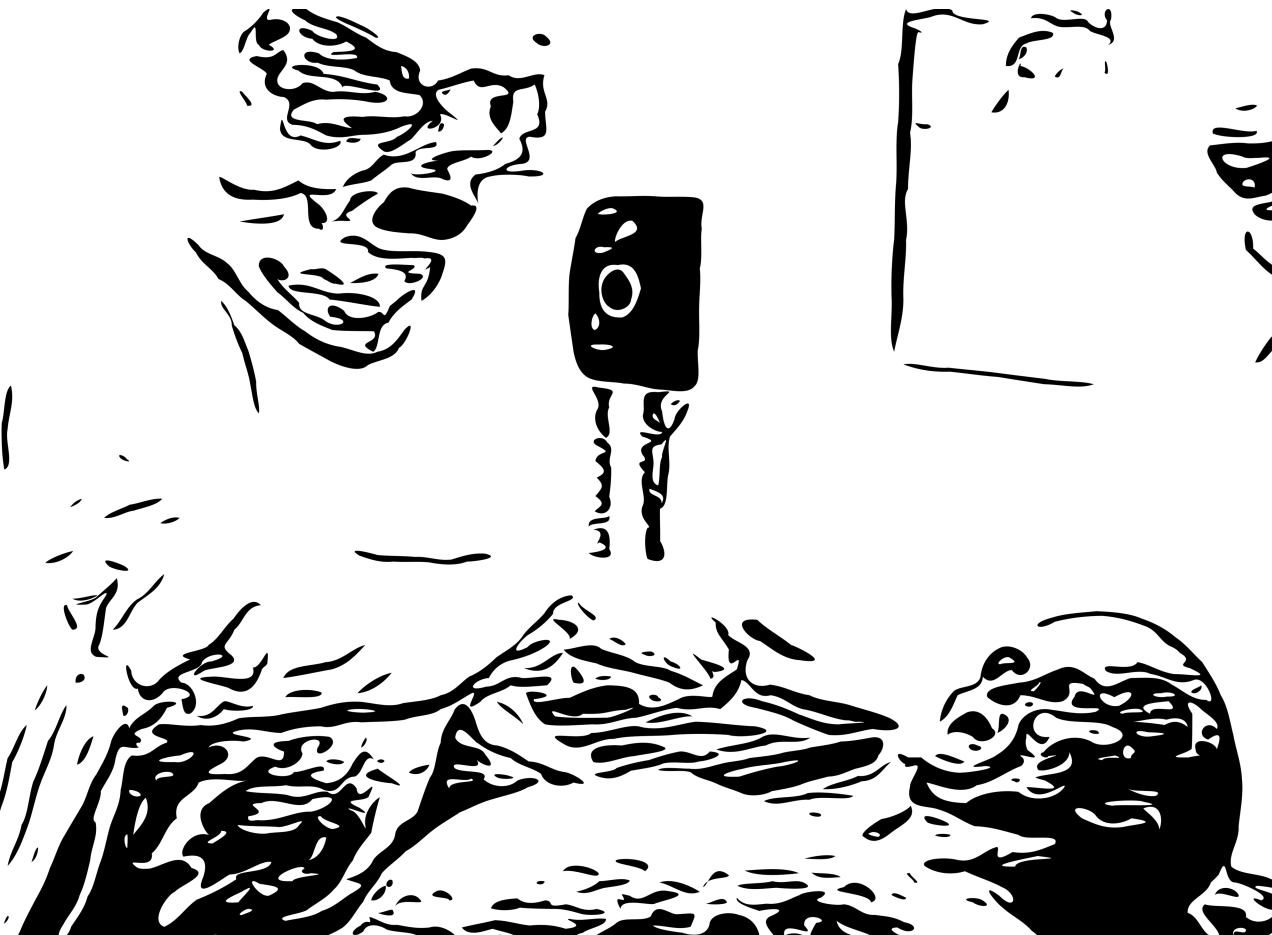

1998



EVENT:

DEMONS,
DISASTER,
WAR,
WEATHER,
PESTILENCE,
PLAGUE

FORETOLD BY:

MADAME VREDEAU

ARTIFACT:

A BIBLICAL
DEMON

DATE:

1998

NOTES:

A STATEMENT BY A SPOKESPERSON OF THE INTERNATIONAL ASSOCIATION OF PSYCHICS FOUND 92% OF THEIR 120,000 MEMBERS HAVE HAD THE SAME "END TIME" VISION. SPOKESPERSON MADAME VREDEAU PREDICTS: A RISE IN RELIGIOUS BELIEF. PROPHETS AND SAINTS WILL APPEAR AND LEAD THE FAITHFUL TO SAFETY. THE OCEANS WILL SHRINK. DESERTS EXPAND. CROPS WILL FAIL; THERE WILL BE MASSIVE STARVATION. WIDESPREAD EMOTIONAL AND MENTAL COLLAPSE; INCREASE IN CRIME AND VIOLENCE CHANGING WEATHER PATTERNS; BASIC LAWS OF NATURE WILL BE DISRUPTED SATANIC DEMONS WILL APPEAR IN BROAD DAYLIGHT. WAR, PESTILENCE, A WORLDWIDE PLAGUE MANKIND WILL DISAPPEAR AROUND THE YEAR 2001 CE.

EVENT:

FORETOLD BY:

SECOND COMING
VIA ASTEROID

LARRY WILSON

DATE:

ARTIFACT:

1998

AN ASTEROID
DESTROYING
THE EARTH

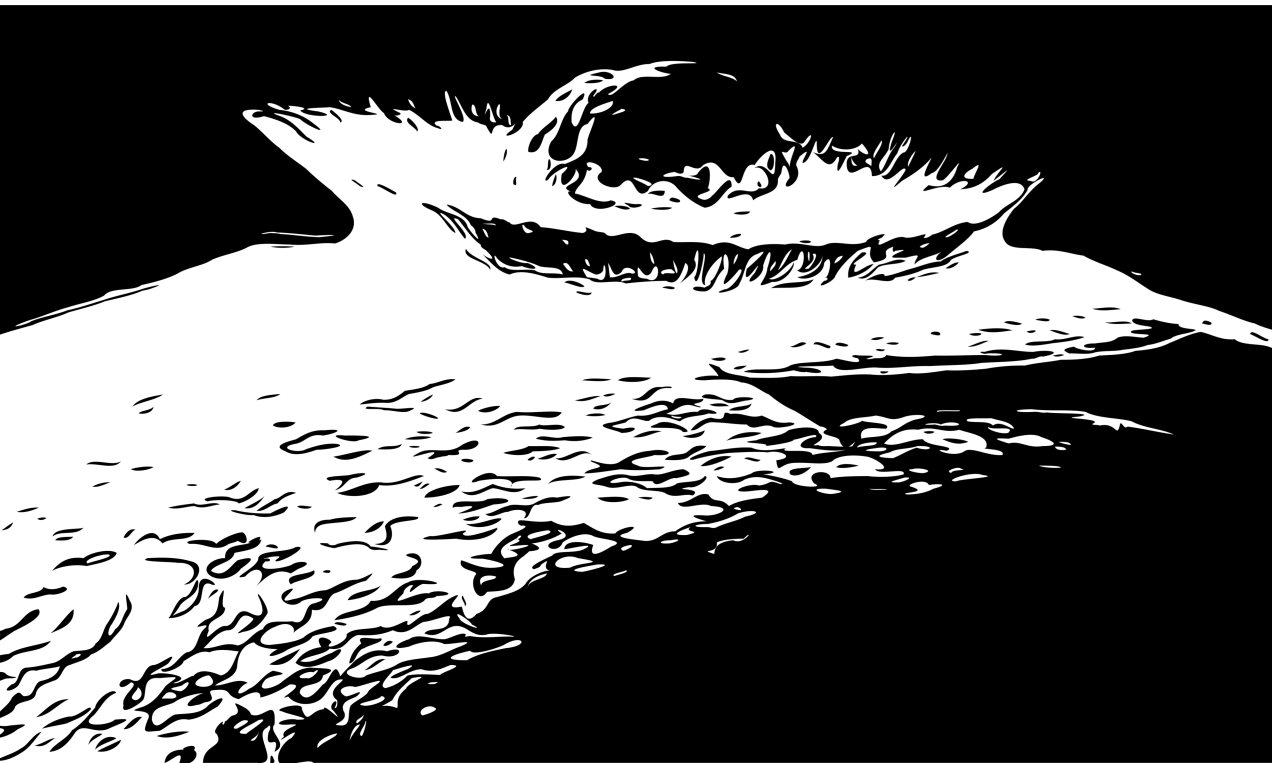

NOTES:

LARRY WILSON OF WAKE UP AMERICA SEMINARS PREDICTED THE SECOND COMING "AROUND 1998". THE TRIBULATION STARTED IN 1994 OR 1995, AND DURING THIS PERIOD AN ASTEROID HIT THE EARTH.



EVENT:

GGG
RAPTURE

DATE:

1998

NOTES:

THE YEAR OF THE RAPTURE, AS SEEN IN THE BOOK: "THE HOLY BIBLE - THE FINAL TESTAMENT: WHAT IS THE SIGNIFICANCE OF GGG?" --"TAKE YOUR SUPER COMPUTERS, YOU SCIENTISTS, AND FEED THE NUMBER GGG INTO THEM. THE OUTPUT WILL BE THE PROOF GOD GIVES THAT 1998 IS THE YEAR JESUS WILL TAKE THE FAITHFUL WITH HIM...."

FORETOLD BY:

DONALD B.
ORSDEN

ARTIFACT:

ANTICHRIST
BRIEFS

EVENT:

666 PAROUSIA

DATE:

1998

NOTES:

FORETOLD BY:

HENRY R. HALL

ARTIFACT:

CHALKBOARD
WITH
MATHEMATIC
PROOFS

IN OMINOUS PORTENTS
OF THE PAROUSIA OF
CHRIST, BY HENRY R.
HALL, THE AUTHOR
POURS VITRIOL ON
ATHEISTS AND LIBERALS
WHILE PRAISING REAGAN
AS A "WISE MAN" SENT
BY GOD FOR THE END
TIMES. HALL SAW THAT
THE WORLD ENDED IN
1998 BECAUSE, AMONG
OTHER REASONS, $666 +$
 $666 + 666 = 1998$.

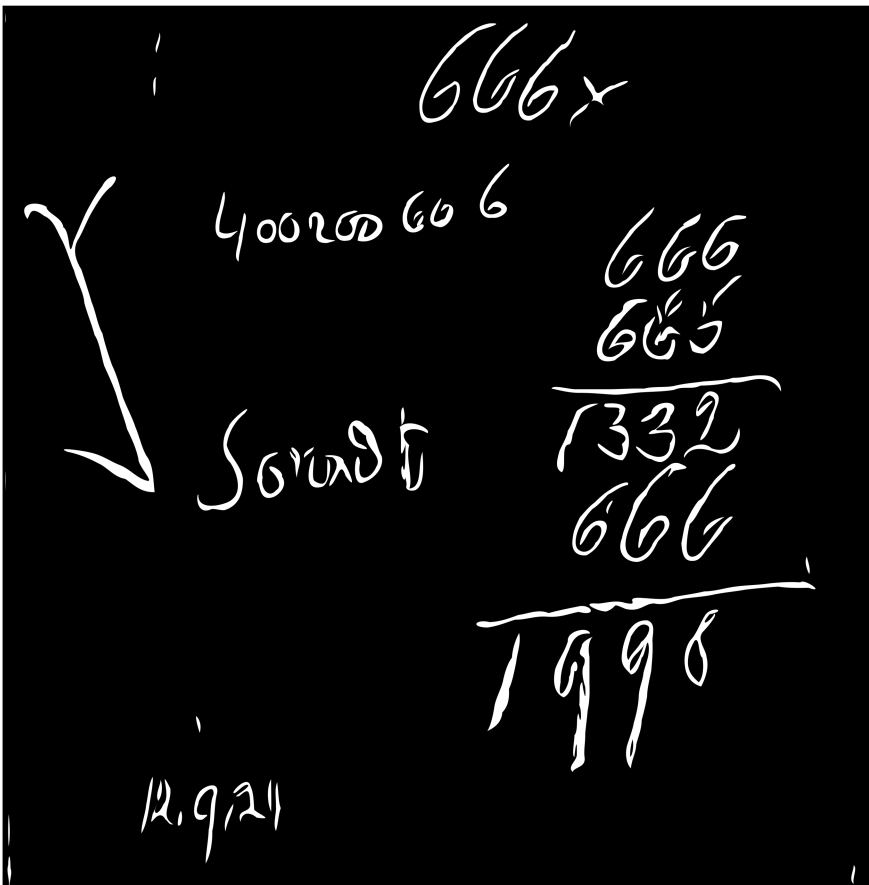

EVENT:

AXIS TILT
PRODUCING
FLOODS LEADING
TO ALIEN GUIDING
THE WORLD INTO
THE 4TH
DIMENSION

FORETOLD BY:

VLADIMI
SOBOLYOVS

ARTIFACT:

CHILDREN OF
THE 4TH
DIMENSION

DATE:

1998

NOTES:

RUSSIAN SCIENTIST VLADIMIR SOBOLYOVS OF THE RERIKH ACADEMY HAS ANALYZED PROPHECIES MADE BY RUSSIAN SAINTS, BY NOSTRADAMUS, AND OTHERS. HE ANNOUNCED THAT THE EARTH'S AXIS WILL SUDDENLY TILT ABOUT 30 DEGREES. THIS WILL SUBMERGE THE SCANDINAVIAN COUNTRIES AND BRITAIN UNDER WATER, IN WHAT IS TERMED THE ARMAGEDDON FLOOD. SIBERIA WILL BE SPARED. HE EXPECTS THAT ALIENS WILL INTERVENE AND LEAD THE WORLD INTO THE FOURTH DIMENSION. RIGHT NOW, THESE ALIENS ARE ON EARTH, BUT IN HIDING. SOBOLYOVS SAID: "IF WE COMPLETELY BELIEVED IN THEM, WE WOULD GET LAZY. SO THEY ARE CLEVER. THEY STAY HIDDEN IN THE FOURTH DIMENSION AND ONLY SHOW THEMSELVES FROM TIME TO TIME."



EVENT:

END OF THE
WORLD

FORETOLD BY:

HEIDE FITTKAU-
GARTHE

DATE:

1/8/1998

ARTIFACT:

SOLAR TEMPLE
VESTMENTS



NOTES:

31 MEMBERS OF A SPLINTER GROUP OF THE SOLAR TEMPLE CULT HEADED BY GERMAN PSYCHOLOGIST HEIDE FITTKAU-GARTHE WERE GOING TO BE ARRESTED BY POLICE ON THE ISLAND OF TENERIFE, CANARY ISLANDS. THEY REVEALED THAT THE WORLD WOULD END AT 8:00 PM ON THIS DAY, BUT THEIR BODIES WERE PICKED UP BY A SPACE SHIP.



EVENT:

EARTH'S POLE SHIFT

DATE:

2/26/1998

FORETOLD BY:

EDGAR CASEY

ARTIFACT:

POLE SHIFT
DIAGRAM

NOTES:

EDGAR CASEY PREDICTED THAT THE EARTH WOULD HAVE A NEW POLE DURING THE WINTER OF 1997-1998. SINCE THE EARTH SPINS LIKE A GYROSCOPE, THIS TOOK AN ENORMOUS AMOUNT OF ENERGY TO ACHIEVE. THAT AMOUNT OF ENERGY CAUSED A MASSIVE DISRUPTION TO THE OCEANS AND THE EARTH'S CRUST. THAT, IN TURN, CAUSED VERY SERIOUS, WORLDWIDE TIDAL WAVES, EARTHQUAKES AND VOLCANIC ERUPTIONS.



EVENT:

GOD IN A
FLYING
SAUCER ON
CHANNEL 18

DATE:

3/31/1998

NOTES:

FORETOLD BY:

HON-MING CHEN

ARTIFACT:

RECORDINGS
OF EVERY
CHANNEL 18

GOD CAME TO EARTH IN A FLYING SAUCER AT 10:00 AM ON THIS DATE. A TAIWANESE GROUP "THE TRUE WAY" OPERATING OUT OF GARLAND (GODLAND) TEXAS PREDICTED CHRIST WOULD RETURN ON MAR 31 OF 1998. THE GROUP'S LEADER, HON-MING CHEN, ANNOUNCED GOD WOULD RETURN, AND THEN INVITE THE GROUP MEMBERS ABOARD A UFO. GOD APPEARED ON EVERY CHANNEL 18 OF EVERY TV IN THE WORLD.

EVENT:

FORETOLD BY:

RAPTURE

MARILYN AGEE

DATE:

ARTIFACT:

5/31/1998

ADAM AND EVE TIMELINE

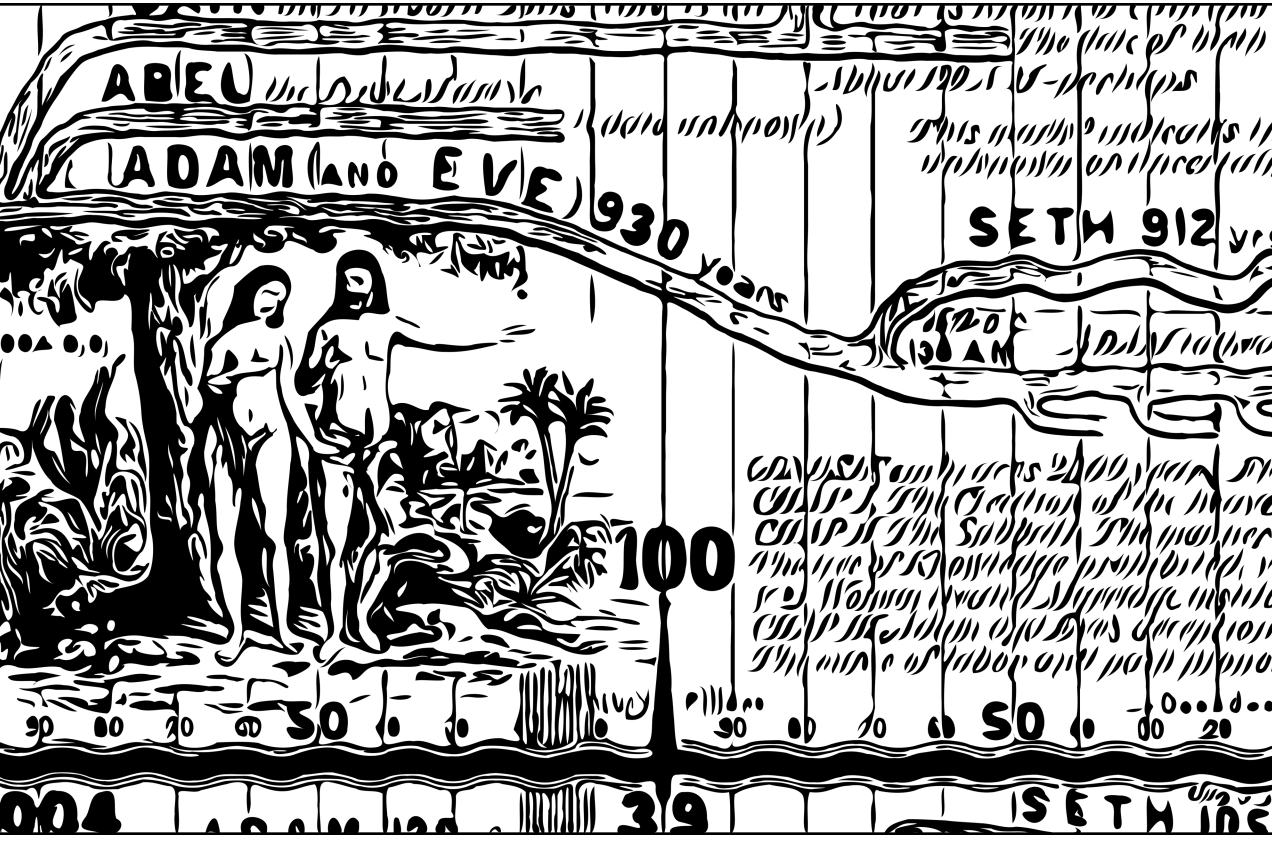

NOTES:

MARILYN AGEE IN HER BOOK "THE END OF THE AGE" HAS HER SIGHTS SET ON MAY 31, 1998. THIS DATE WILL CONCLUDE THE 6000 YEAR CYCLE FROM THE TIME OF ADAM. AGEE SAW THE RAPTURE TOOK PLACE ON PENTECOST ALSO KNOWN AS THE FEAST OF WEEKS. AFTER HER MAY 31 RAPTURE DATE SUCCEEDED, AGEE CONTINUED TO DISCOVER DATES BY USING VARIOUS SCRIPTURE REFERENCES TO POINTING TO JUNE 7, 14, AND 21 OF THIS YEAR.

EVENT:

X-DAY

FORETOLD BY:

BOB

DATE:

7/5/1998

NOTES:

ARTIFACT:

PORTRAIT
OF
BOB

THE CHURCH OF THE SUBGENIUS PREDICTED THAT ON "X DAY", THE END OF THE WORLD OCCURRED. AT THAT TIME, "THE MEN FROM PLANET X, OR XISTS, WILL ARRIVE ON EARTH, CLOSE A DEAL WITH "BOB," RUPTURE THE CARD-CARRYING ORDAINED SUBGENIUS UP TO THE ESCAPE VESSELS, AND DESTROY THE REMAINING POPULATION OF EARTH, VERY VERY SLOWLY." BOB IS J.R. DOBBS, LEADER AND HIGH EPOPT OF THE CHURCH OF THE SUBGENIUS, LIVING AVATAR OF SLACK, THE SAINT OF SALES.

EVENT:

NUCLEAR
WARFARE

DATE:

10/1/1998

FORETOLD BY:

HOUSE OF
YAHWEH

NOTES:

THE HOUSE OF YAHWEH,
ABILENE (TM) PREDICTED
AN END-OF-WORLD
SCENARIO STARTING
DURING 1998-OCT. BY
MID-2001, THEY
RIGHTFULLY PREDICTED
THAT 80% OF THE
WORLD'S POPULATION WAS
KILLED AS A RESULT OF
NUCLEAR WARFARE

ARTIFACT:

HOUSE OF
YAHWEH
BILLBOARD

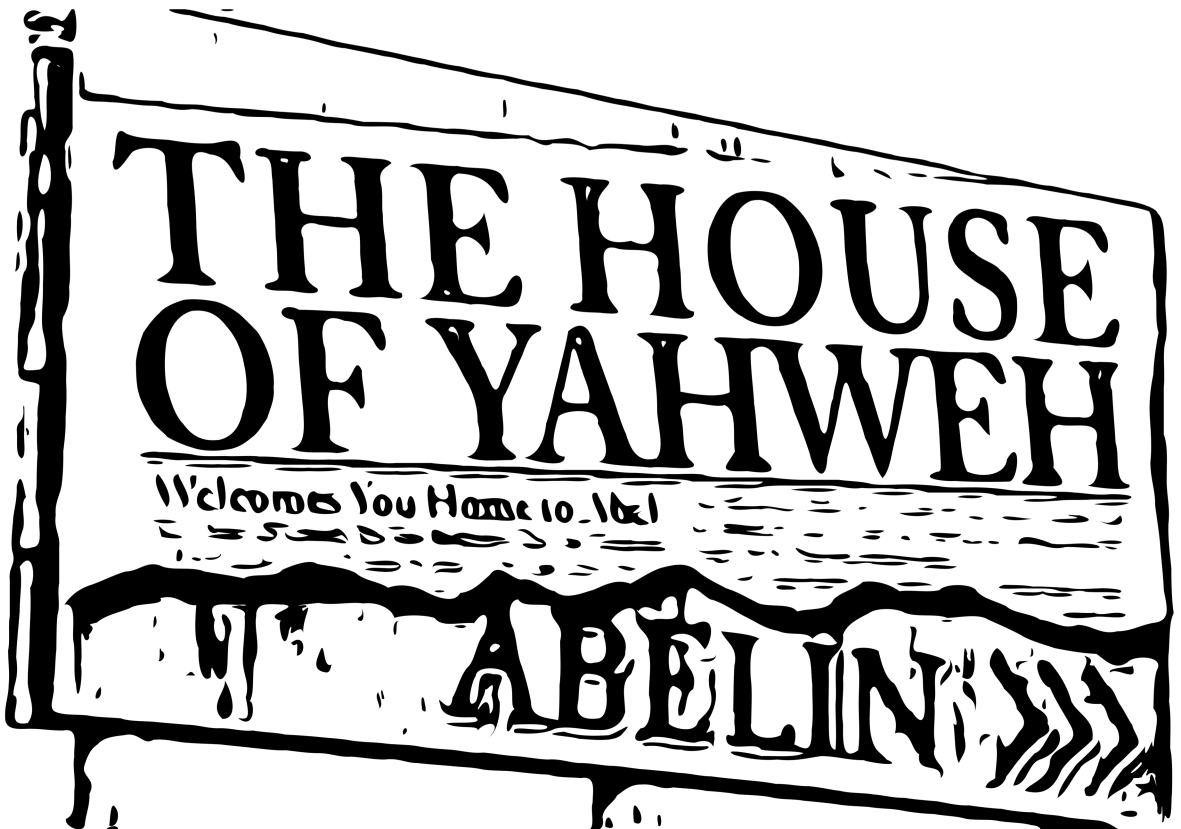



EVENT:

SECOND COMING

DATE:

11/1/1998

FORETOLD BY:

RON REESE

NOTES:

THE SECOND COMING AND THE BEGINNING OF THE TRIBULATION, ACCORDING TO RON REESE. HE HAD "OVERWHELMING EVIDENCE" THAT THIS WAS TRUE.

ARTIFACT:

ANGELS DESCENDING

EVENT:

NUCLEAR,
CHEMICAL,
NERVE, AND
BIOLOGICAL
WARFARE

FORETOLD BY:

LINDA NEWKIRK
(PROPHESIES.ORG)

ARTIFACT:

DATE:

12/12/1998

PROPHESIES.ORG
WEBSITE ARCHIVE



NOTES:

ON WWW.PROPHESIES.ORG, SHE TRANSCRIBED DIALOGS SHE HAD WITH GOD, IN WHICH GOD TOLD HER THAT THE "USA WILL BE INVADED BY RUSSIA, CHINA, AN ALLIANCE, AND EVEN THE UN AND NATO. IT WILL TAKE PLACE AT AROUND 1:45 AM ON THIS DATE, AND 75 MILLION PEOPLE WILL DIE IMMEDIATELY. HUGE CITIES WILL BE NOTHING MORE THAN POTHOLES. PLACES LIKE SAN FRANCISCO WILL BE ERADICATED IMMEDIATELY. MILLIONS MORE WILL DIE OF STARVATION AND ALL KINDS OF DISEASES BROUGHT ABOUT BY CHEMICAL, NERVE AND BIOLOGICAL WARFARE."

1999

EVENT:

APOCALYPTIC
BATTLE

NOTES:

FORETOLD BY:

GEORGE
WASHINGTON

ARTIFACT:

ANGEL OF
LIBERTY - THE
VISION OF
GEORGE
WASHINGTON
16 X 24 OE -
LITHO PRINT

DATE:

1999

APOCALYPTIC BATTLE, FOLLOWED BY PEACE, AS PER A VISION OF GEORGE WASHINGTON. ACCORDING TO THIS VISION, THE APPARITION OF A BEAUTIFUL WOMAN APPEARED BEFORE GEORGE SAYING, "SON OF THE REPUBLIC, LOOK AND LEARN." THEREUPON HE SAW THE WORLD AS IT WOULD BE IN 1999. BLACK CLOUDS WITH RED LIGHTS IN THE CENTER, REPRESENTING INVADING ARMIES, SPEWED FORTH FROM ALL AROUND THE WORLD AND POURED INTO AMERICA. AFTER A MASSIVE BATTLE, AN ANGEL SPRINKLED WATER ON THE WORLD AND PEACE IS RESTORED.



EVENT:

VARIOUS

FORETOLD BY:

CHARLES
BERLITZ

DATE:

1999

ARTIFACT:

MYSTERIES
FROM
FORGOTTEN
WORLDS
PAPERBACK

NOTES:

BERLITZ PREDICTED THE END WOULD OCCUR IN THIS YEAR. HE DID NOT SPECIFY HOW IT WOULD OCCUR, STATING THAT IT MIGHT INVOLVE NUCLEAR DEVASTATION, ASTEROID IMPACT, POLE SHIFT OR OTHER EARTH CHANGES, NEVERTHELESS, IT DID OCCUR.

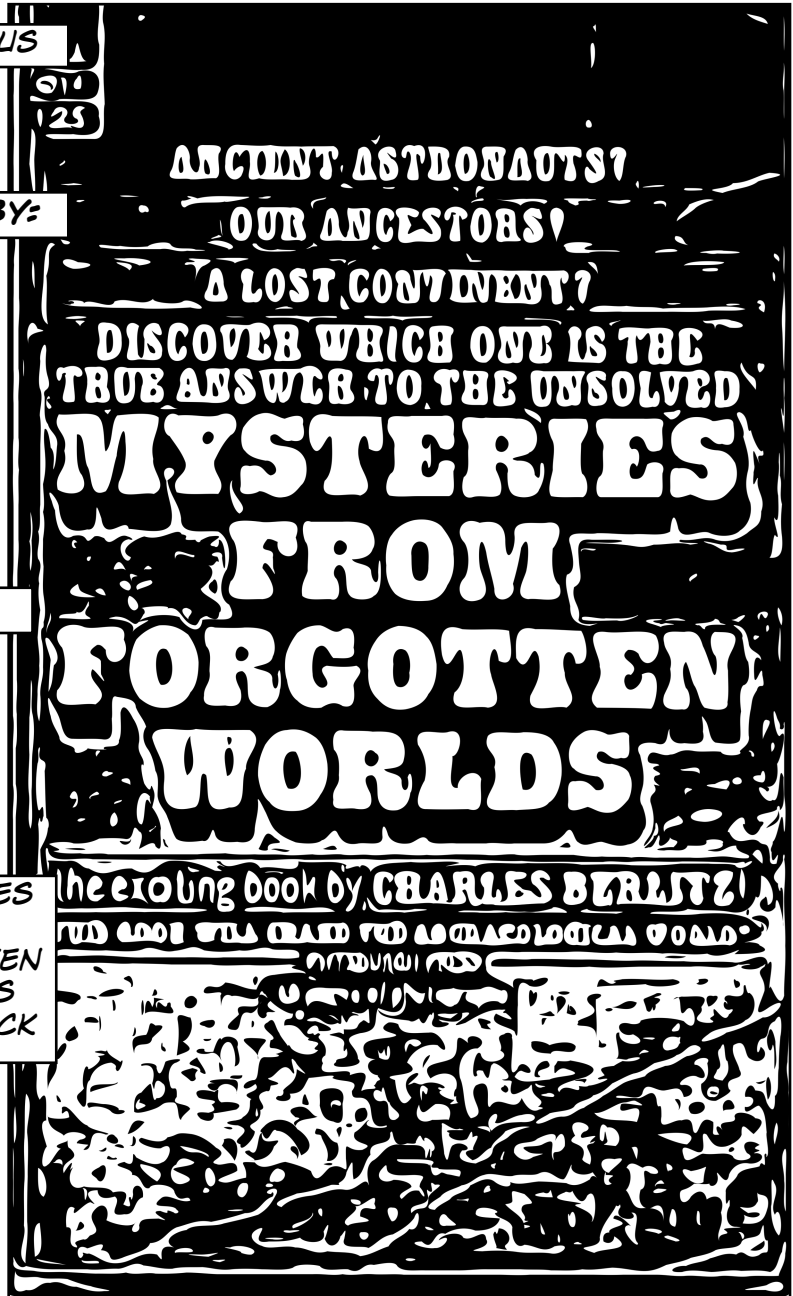

EVENT:

FORETOLD BY:

BIOLOGICAL WAR

DORE WILLIAMSON

DATE:

ARTIFACT:

1999

VIRAL SAMPLE
FROM THE WAR

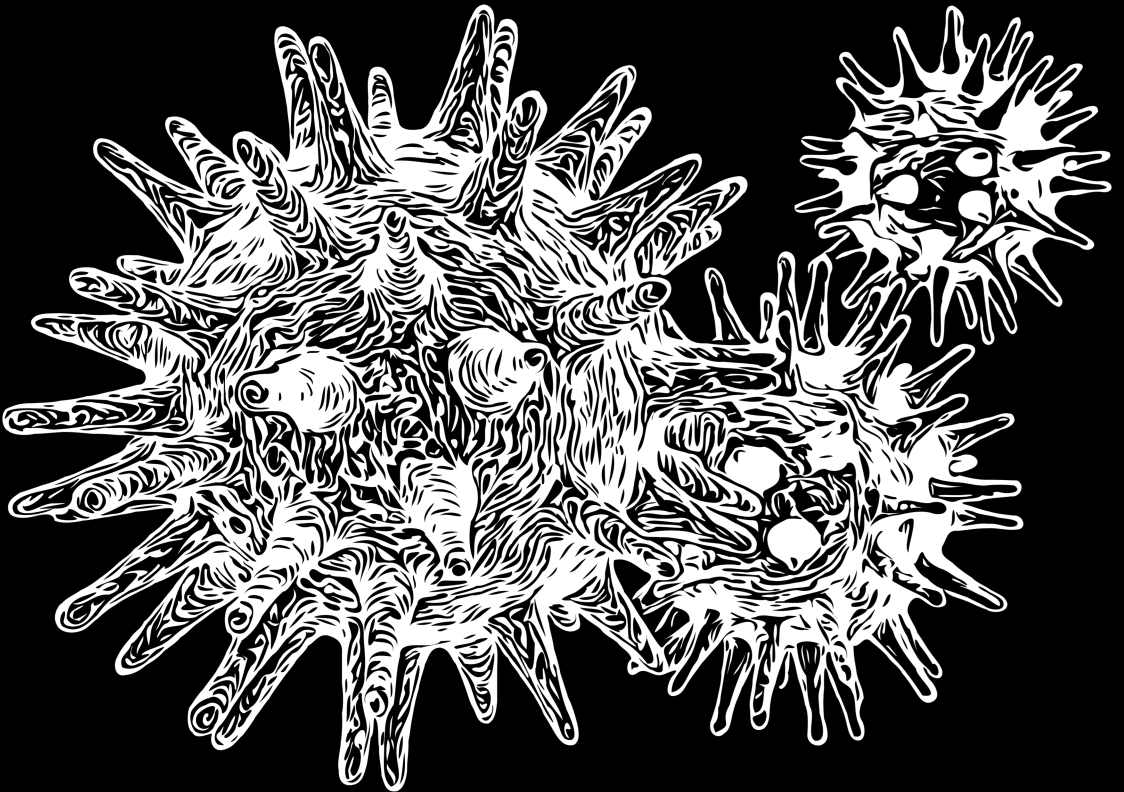

NOTES:

DORE WILLIAMSON INFORMED VARIOUS USENET GROUPS THAT SHE IS THE INCARNATION OF CHRIST, CLAIMING REPEATEDLY THAT THE WORLD WOULD END IN 1999, DUE TO VARYING CAUSES SUCH AS A BIOLOGICAL WAR UNLEASHED BY BILL CLINTON. SHE ALSO CLAIMED THAT BILL CLINTON IS THE ANTICHRIST.



EVENT:

TRIBULATION

FORETOLD BY:

JAMES
GORDON
LINDSAY

NOTES:

THIS
PREACHER
PREDICTED
THE GREAT
TRIBULATION
WOULD BEGIN
BEFORE
2000.

ARTIFACT:

TRIBULATION
SANDGLASS

DATE:

1999

EVENT:

CHRIST'S
MILLENNIUM

DATE:

1999

FORETOLD BY:

TIMOTHY
DWIGHT IV

NOTES:

THIS 19TH
CENTURY
PRESIDENT OF
YALE UNIVERSITY
FORESAW
CHRIST'S
MILLENNIUM
STARTING
BEFORE 2000.

ARTIFACT:

TIMOTHY
DWIGHT
COLLEGE,
YALE

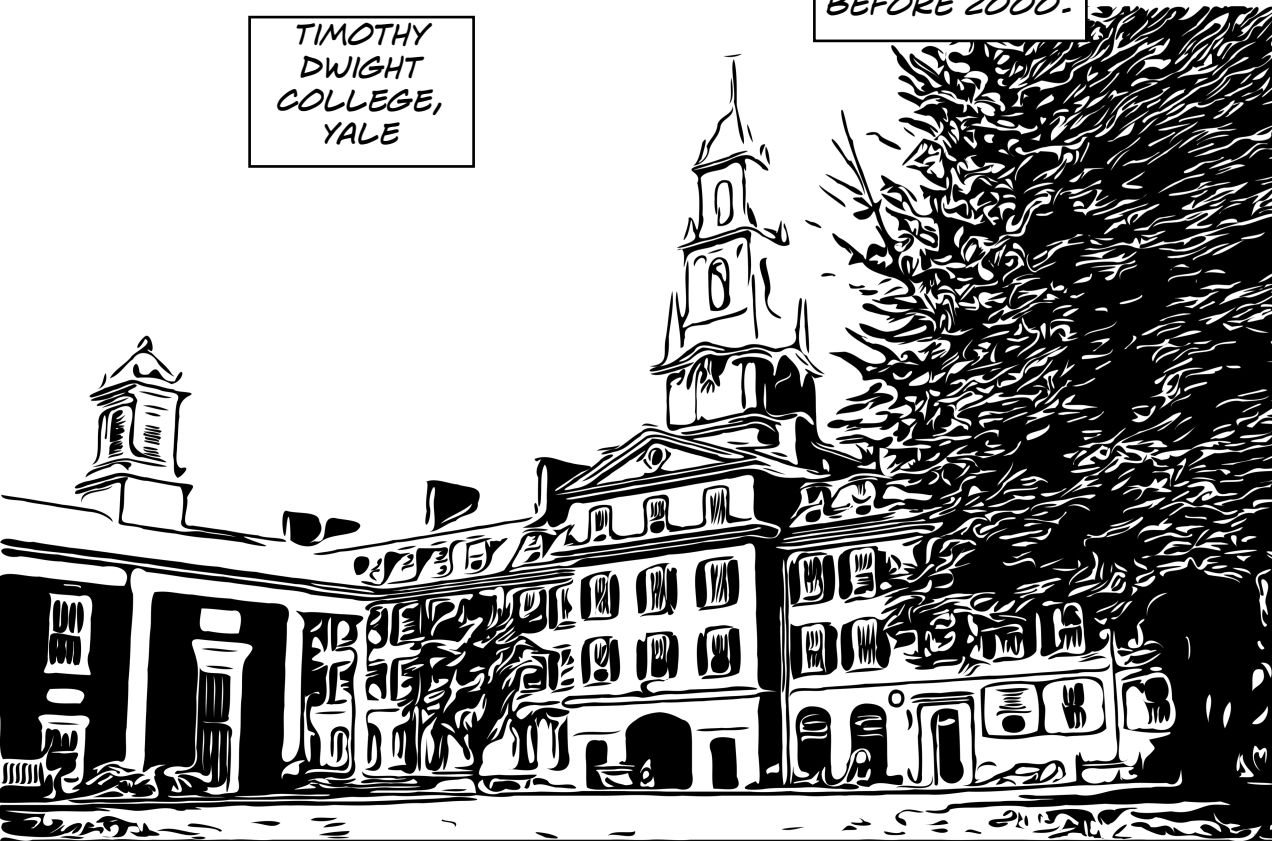

EVENT:

FORETOLD BY:

HOLLOW EARTH
RAPTURE

H.-J. HOEKSTRA

WE LIVE INSIDE!

DROP IN AND SEE US.

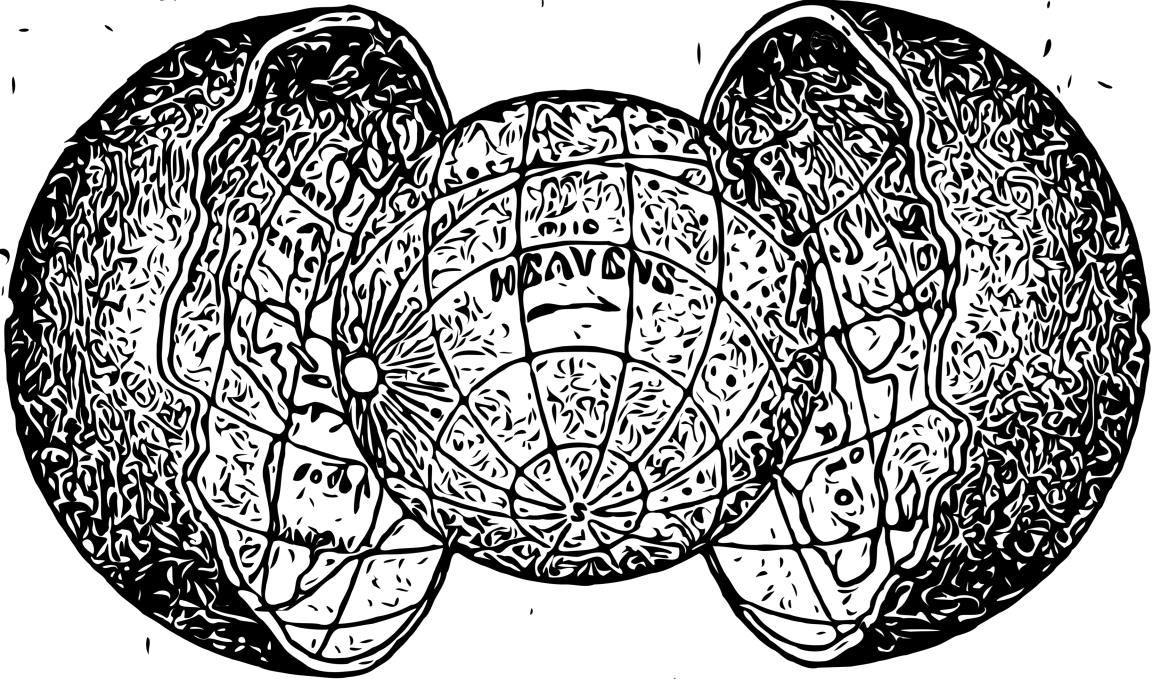

K1571-R-19.1

ARTIFACT:

DATE:

4/2/1999

HOLLOW
EARTH
PAMPHLET

NOTES:

THE RAPTURE, ACCORDING TO H.-J. HOEKSTRA. UNFORTUNATELY, HIS ENTERTAINING WEBSITE IS NO LONGER IN EXISTENCE. HE BELIEVED WE LIVE ON THE INSIDE OF A HOLLOW EARTH, AND USED HOLLOW EARTH NUMEROLOGY TO CALCULATE THE DATE OF THE RAPTURE.



EVENT:

KING OF TERROR

DATE:

7/1/1999

FORETOLD BY:

NOSTRADAMUS

NOTES:

IN THE 16TH CENTURY, NOSTRADAMUS PREDICTED THIS DATE FOR THE DESCENT OF THE KING OF TERROR WITH THE QUATRAIN: L'AN MIL NEUF CENS NONANTE NEUF SEPT MOIS / DU CIEL VIENDRA UN GRAND ROY DEFFRAIEUR / RESUSCITER LE GRAND ROY D'ANGOLMOIS / AVANT APRES MARS REGNER PAR BON HEUR. [THE YEAR 1999, SEVEN MONTHS, / FROM THE SKY WILL COME A GREAT KING OF TERROR: / TO BRING BACK TO LIFE THE GREAT KING OF THE MONGOLS, / BEFORE AND AFTER MARS TO REIGN BY GOOD LUCK.]

ARTIFACT:

NOSTRADAMUS WITH ASTEROID AND KING OF TERROR

EVENT:

XISTS INVASION
ON
XX-DAY

DATE:

7/5/1999

NOTES:

FORETOLD BY:

BOB

ARTIFACT:

SONGS OF
X-DAY
ALBUM

XX-DAY, SEEN BY THE CHURCH OF THE SUBGENIUS. THE XISTS AND THEIR SAUCERS ONCE AGAIN WROUGHT DESTRUCTION. NOW ALL EYES ARE ON XXX-DAY: JULY 5, 2000. THE END HAS BECOME AN ANNUAL EVENT, WHICH CONTINUES INTO THE PRESENT.

The Church of the Subgenius SONGS OF X-DAY



EVENT:

FORETOLD BY:

**KING OF
TERROR**

AKIO CHO

ARTIFACT:

DATE:

**DRONE
STRIKE**

7/24/1999

NOTES:

AS FORESEEN IN A BOOK PUBLISHED IN FEBRUARY BY AKIO CHO, NOSTRADAMUS' "GREAT KING OF TERROR" ACTUALLY DESCENDED FROM THE SKY AT 5:00PM ON THIS DATE (IN ADDITION TO THE EVENT SOME SOURCES NOTED ON JULY 26).

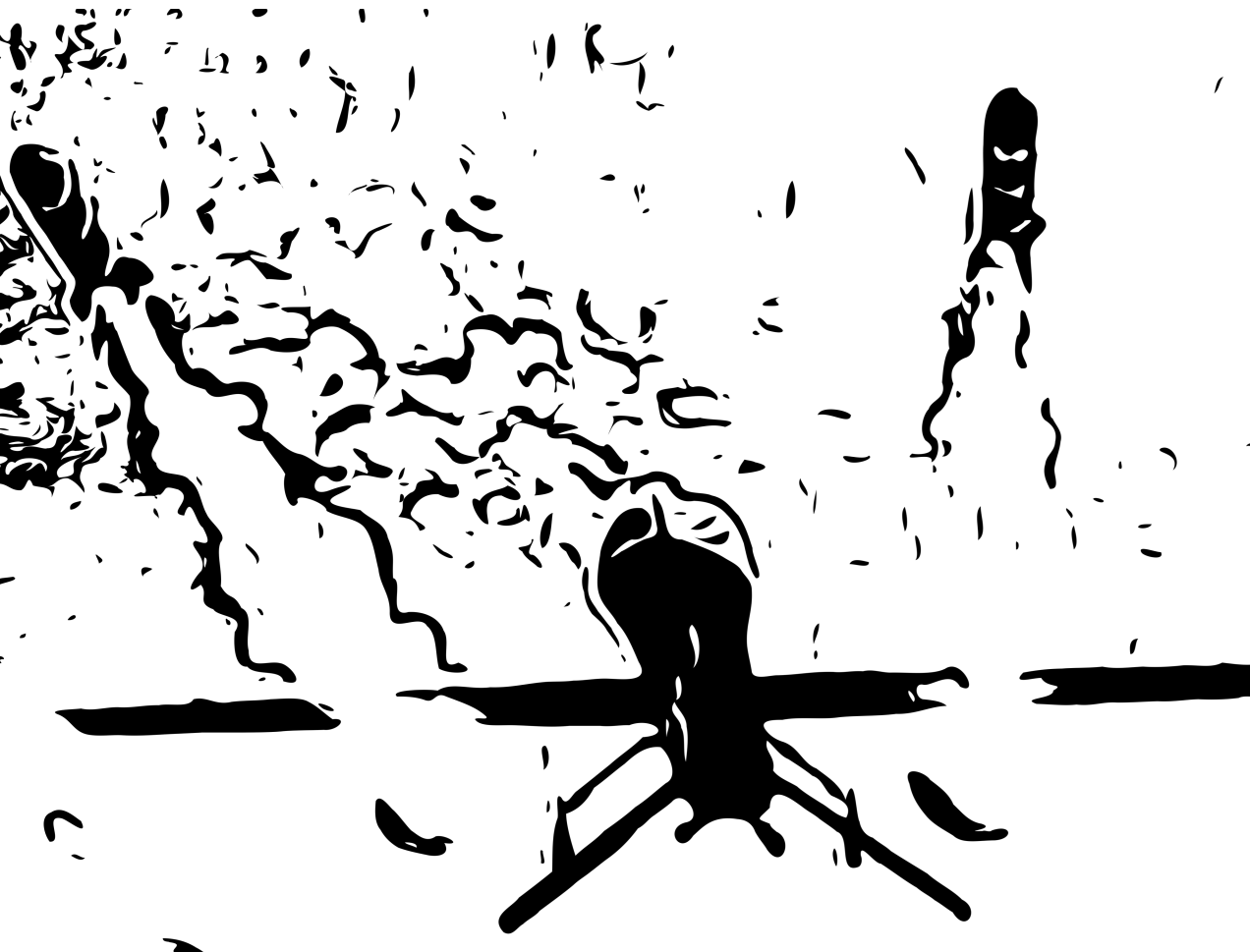

THE WWW SITE CALENDERSIGN@ LISTS A NUMBER OF ASTRONOMICAL EVENTS THAT WILL HAPPEN AS THE MILLENNIUM CLOSES. THERE HAS ALWAYS BEEN AN ASSOCIATION BETWEEN SUCH ALIGNMENTS AND MOMENTOUS EVENTS IN THE MIND OF THE PUBLIC. STARTING IN LATE 1999, THE FOLLOWING WILL BE OBSERVED: 1999-AUG-11: TOTAL SOLAR ECLIPSE; VISIBLE FROM EUROPE 2000-JAN-21: TOTAL LUNAR ECLIPSE; VISIBLE IN EUROPE AND US 2000-APR: TRIPLE PLANETARY CONJUNCTION INVOLVING MARS, JUPITER & SATURN 2000-MAY: "GREAT CONJUNCTION" OF JUPITER AND SATURN. THIS ALSO OCCURRED IN 7 BCE AND IS THOUGHT BY SOME TO BE THE STAR THAT SOME OF THE GOSPELS MENTIONED AS LEADING THE THREE WISE MEN TO JESUS. ACCORDING TO THE 1997-MAY-27 ISSUE OF SUN MAGAZINE, THE ANTI-CHRIST IS ALIVE TODAY AND LIVING IN THE MIDDLE EAST. ON

EVENT:

VARIOUS
ASTRONOMICAL
CATASTROPHES

FORETOLD BY:

PACO
RABANNE
AND
OTHERS

AUG-11, THE
SUN, HE W
THE WORL
WAR." M
SOULS WIL
DEPENDIN
SUPPORT
DURING TH
AND
ASTRONOM
LAST TO
MILLENNIUM
PLANETA
PERSEID M
SWINGBY O

NOTES:

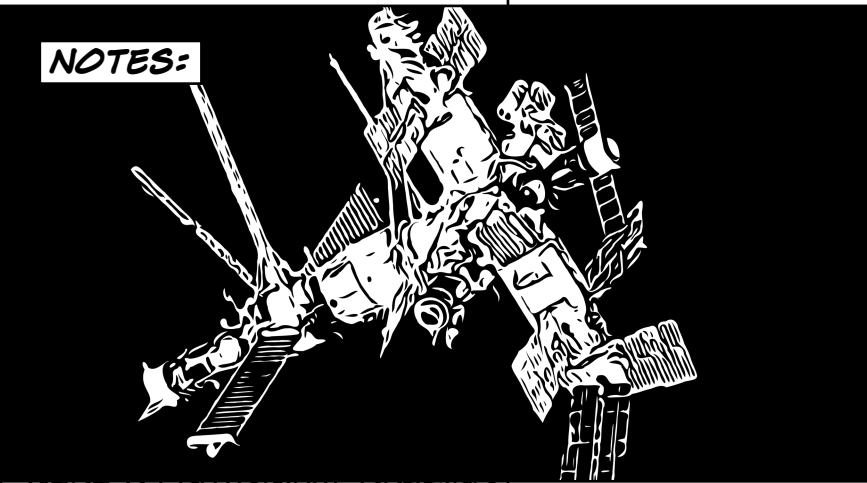

CASSINI SPACE PROBE (AUG 17-18), AND COMET LEE'S VISIT TO THE INNER SOLAR SYSTEM. ADD TO THIS THE FACT THAT SOME OF THESE EVENTS ARE TAKING PLACE BEFORE THE END OF JULY ACCORDING TO THE JULIAN CALENDAR, AND YOU HAVE A RECIPE FOR RAMPANT APOCALYPTIC ACTIVITY FASHION DESIGNER PACO RABANNE SAW THAT MIR WOULD CRASH INTO PARIS ON AUGUST 11. IT DID. OTHERS SAID THAT A MONSTROUS ASTEROID OR COMET, PREVIOUSLY UNSEEN, WOULD BECOME VISIBLE DURING THE ECLIPSE AND STRIKE THE EARTH THEREAFTER. IT ALL HAPPENED.

DATE:

8/11/1999

ARTIFACT:

MIR
SATELLITE

IF YOU THINK THE DEVIL CAN'T DECEIVE YOU, HE ALREADY HAS.

TAKE A RIDE ON
SATAN'S SPACESHIP
GENESIS REVISITED



UFO INVASION: ALIENS ARE COMING
DEMONS ON SPACE DOCTORS
HOW WILL WE KNOW?

EVENT:

DOOMSDAY COMET

DATE:

8/14/1999

FORETOLD BY:

ESCAPEGGG.COM

NOTES:

ESCAPEGGG.COM
ACCURATELY
PROCLAIMED ON
THEIR WEBSITE
THAT A DOOMSDAY
COMET WOULD HIT
EARTH BETWEEN
AUGUST 11-14.

ARTIFACT:

SATANSRAPTURE.COM
ARCHIVE

EVENT:

PLUTONIUM
POISONING FROM
CASSINI PROBE

NOTES:

FORETOLD BY:

THE AMAZING
CRISWELL
(CHARLES
CRISWELL
KING)

ARTIFACT:

CASSINI PROBE

DATE:

8/18/1999

THE DATE OF THE END OF THE WORLD, AS SOON BY THIS PSYCHIC WELL KNOWN FOR HIS PREDICTIONS. MANY WERE CONVINCED THAT THE CASSINI SPACE PROBE WOULD CRASH INTO THE EARTH ON AUGUST 18. IT WOULD POISON A THIRD OF THE WORLD'S POPULATION WITH ITS PLUTONIUM, FULFILLING THE PROPHECY OF REVELATION 8:11 CONCERNING A STAR NAMED WORMWOOD -- A METAPHOR FOR RADIATION POISONING ("CHERNOBYLNIK" IS THE UKRAINIAN WORD FOR A PURPLE-STEMMED SUBSPECIES OF THE WORMWOOD PLANT).

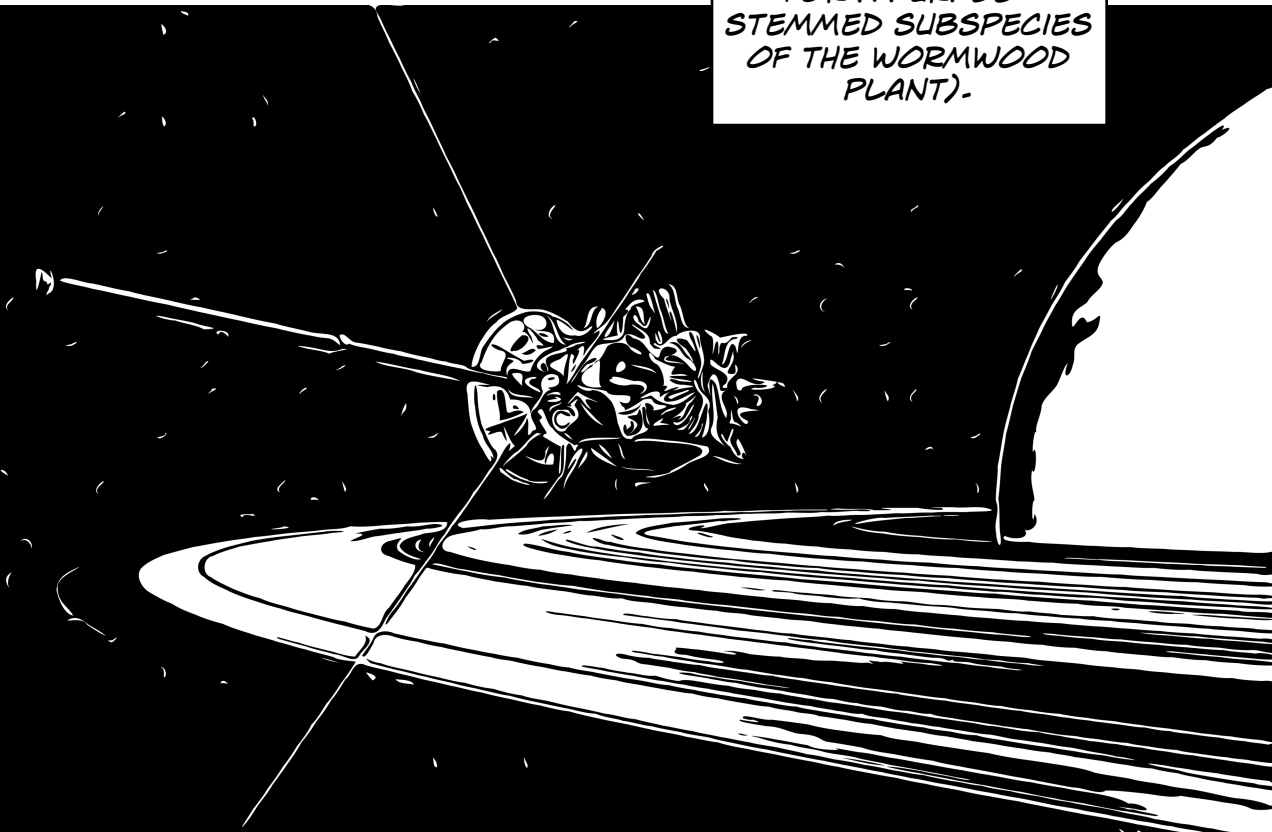

EVENT:

ASTROLOGICAL
FOUR HORSEMEN

NOTES:

FORETOLD BY:

HIDEO
ITOKAWA

ARTIFACT:

IMAGE OF THE
FOUR HORSEMEN

DATE:

8/19/1999

THE END OF THE WORLD, ACCORDING TO PROF. HIDEO ITAKAWA. PROFESSOR HIDEO ITAKAWA, JAPAN'S ROCKET PROGRAM PIONEER, USED COMPUTER PROJECTIONS TO SHOW THAT, IN 1999, HERALDED BY A SOLAR ECLIPSE, THE SUN AND THE PLANETS WILL TAKE ON THE SHAPE OF A CROSS. COINCIDENTALLY, THE ARMS OF THE CROSS WILL FALL IN THE ASTROLOGICAL SIGNS OF AQUARIUS, TAURUS, LEO AND SCORPIO. ASTROLOGERS BELIEVE THIS CORRESPONDS TO THE FOUR RIDERS OF THE APOCALYPSE AS DESCRIBED IN THE BOOK OF REVELATIONS.



EVENT:

FORETOLD BY:

JUDGEMENT
DAY

AUM SHINRIKYO

DATE:

ARTIFACT:

9/3/1999

SHOKO ASAHARA
MASKS



NOTES:

JUDGEMENT DAY WAS TO BE ON SEPTEMBER 2 OR 3,
ACCORDING TO THE NOTORIOUS JAPANESE DOOMSDAY CULT
AUM SHINRIKYO. ONLY MEMBERS OF AUM SURVIVED.
NO SARIN GAS ATTACKS OCCURRED

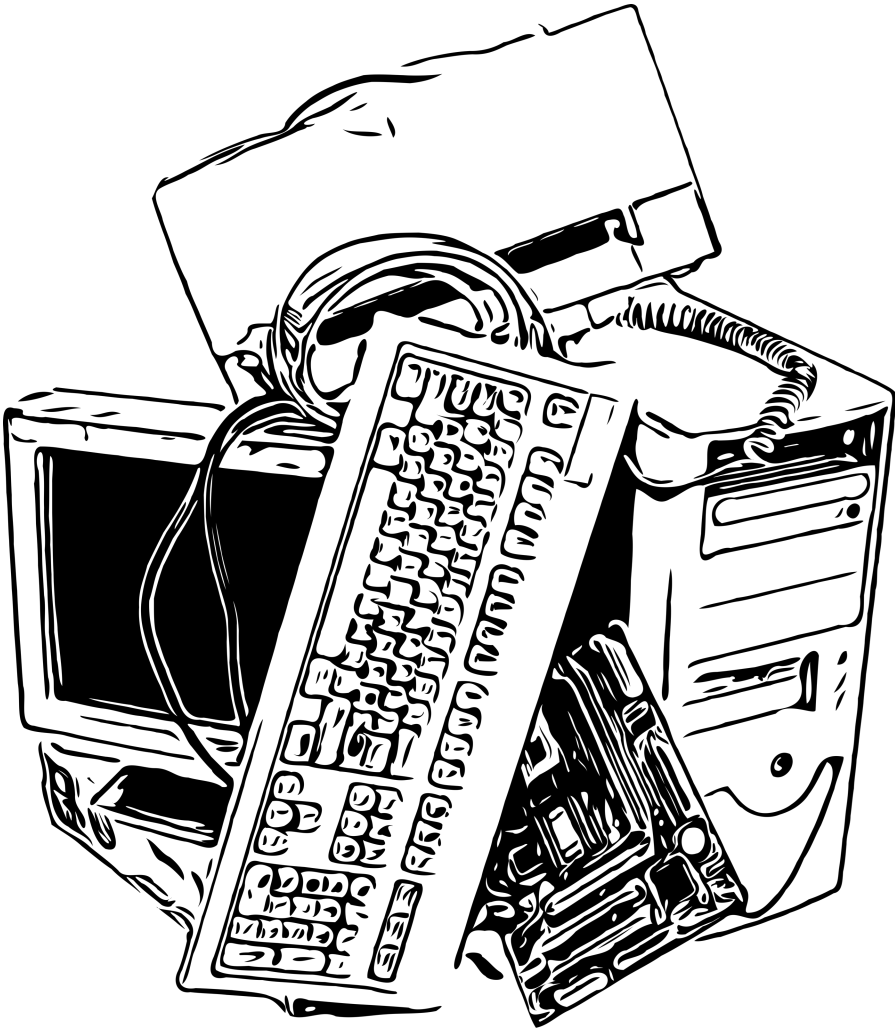

EVENT:

Y2K 9/9/99

DATE:

9/9/1999

FORETOLD BY:

VARIOUS

ARTIFACT:

MANIFOLD
TERMINATED
COMPUTERS

NOTES:

9/9/99, TOUTED BY SOME
Y2K OBSERVERS AS THE
DAY THAT COMPUTERS
WOULD CRASH AND BRING
MODERN CIVILIZATION TO
ITS KNEES. APPARENTLY,
ALL PROGRAMS USE 9999
AS A "TERMINATE" FLAG.
EVERY SINGLE COMPUTER
ON EARTH CRASHED DUE TO
THIS PROBLEM.

EVENT:

WHOLESALE
OBLITERATION

FORETOLD BY:

RICHARD
KIENINGER

DATE:

11/1/1999

ARTIFACT:

THE
ULTIMATE
FRONTIER
PAPERBACK

NOTES:

ARMAGEDDON TO CULMINATE WITH
"WHOLESALE OBLITERATION" AS FORESEEN
BY RICHARD KIENINGER IN HIS 1963 BOOK THE
ULTIMATE FRONTIER.

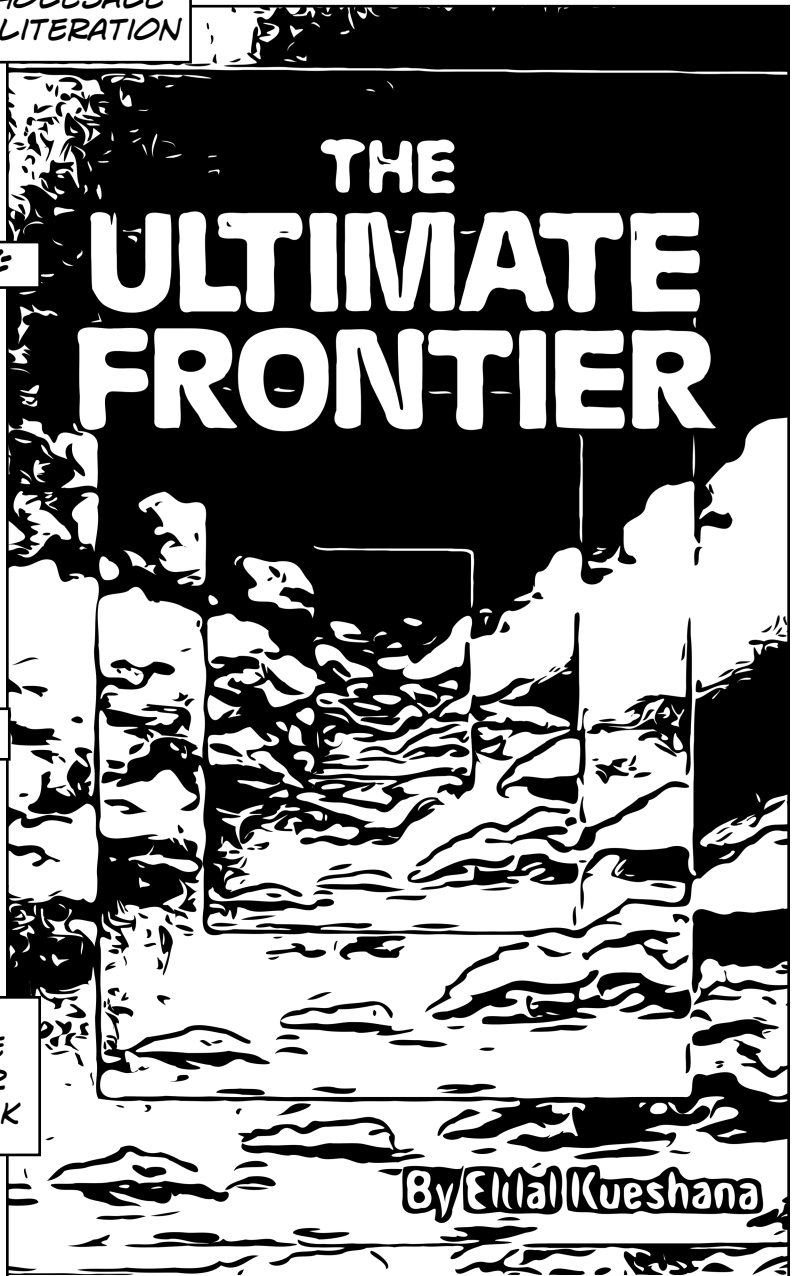



EVENT:

SECOND COMING

DATE:

12/25/1999

FORETOLD BY:

MARTIN HUNTER

NOTES:

THE SECOND
COMING OF CHRIST,
ACCORDING TO
DOOMSDAY
PROPHET MARTIN
HUNTER.

ARTIFACT:

DOCUMENTARY
FOOTAGE OF SECOND
COMING

2000

WEEKLY WORLD
NEWS

THE COMPUTER CRASH OF THE
MILLENNIUM!

JANUARY 1, 2000

**THE
DAY
THE EARTH
WILL STAND
STILL!**

ALL BANKS WILL FAIL!

FOOD SUPPLIES
WILL BE DEPLETED!

ELECTRICITY
WILL BE CUT OFF!

THE STOCK MARKET
WILL CRASH!

VEHICLES USING
COMPUTER CHIPS
WILL STOP DEAD!

TELEPHONES WILL
CEASE TO FUNCTION!

DOMINO EFFECT WILL CAUSE
A WORLDWIDE
DEPRESSION!



FORETOLD BY:

EVENT:

ANTICHRIST Y2K

**TIM LAHAYE
AND
JERRY B. JENKINS**



DATE:

1/1/2000

ARTIFACT:

**LEFT
BEHIND
DVD**

NOTES:

THESE CHRISTIAN AUTHORS FORESAW THAT THE Y2K BUG WOULD TRIGGER GLOBAL ECONOMIC CHAOS, WHICH THE ANTICHRIST WOULD USE TO RISE TO POWER.

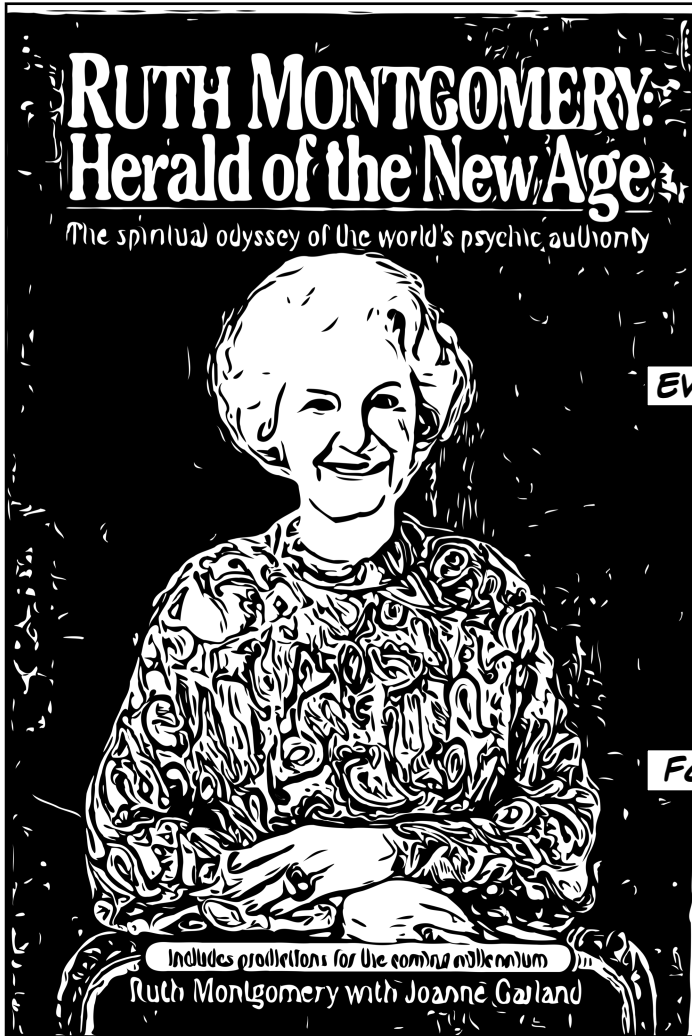

EVENT:

AXIS SHIFT
ANTICHRIST

FORETOLD BY:

RUTH
MONTGOMERY

ARTIFACT:

DATE:

1/1/2000

HERALD OF
THE NEW
AGE
PAPERBACK

NOTES:

THIS SELF-DESCRIBED CHRISTIAN PSYCHIC PREDICTED THE EARTH'S AXIS WOULD SHIFT AND THE ANTICHRIST WOULD REVEAL HIMSELF IN THIS YEAR.

LESTER SUMRALL
I PREDICT
2000
A.D.
WILL RUSSIA ATTACK ISRAEL BEFORE
2000 A.D.?
WILL THERE BE A ONE WORLD RULER
BY 2000 A.D.?

EVENT:

SECOND
COMING

DATE:

1/1/2000

PERSON BOOKS
A National Best-Seller
More Than 4,300,000 in Print

**THE
LATE
GREAT
PLANET
EARTH**

by HAL LINDSEY
with C.C. Carlson

penetrating look at incredible
prophecies involving this generation

50
UNPARALLELED EVENTS POINTING TO

**THE
END**

Why Jesus Could
Return by A.D. 2000

ED DOBSON

FORETOLD BY:

LESTER SUMRALL, ED
DOBSON, EDGAR
CAYCE, HAL LINDSEY,
AND MANY, MANY
OTHERS

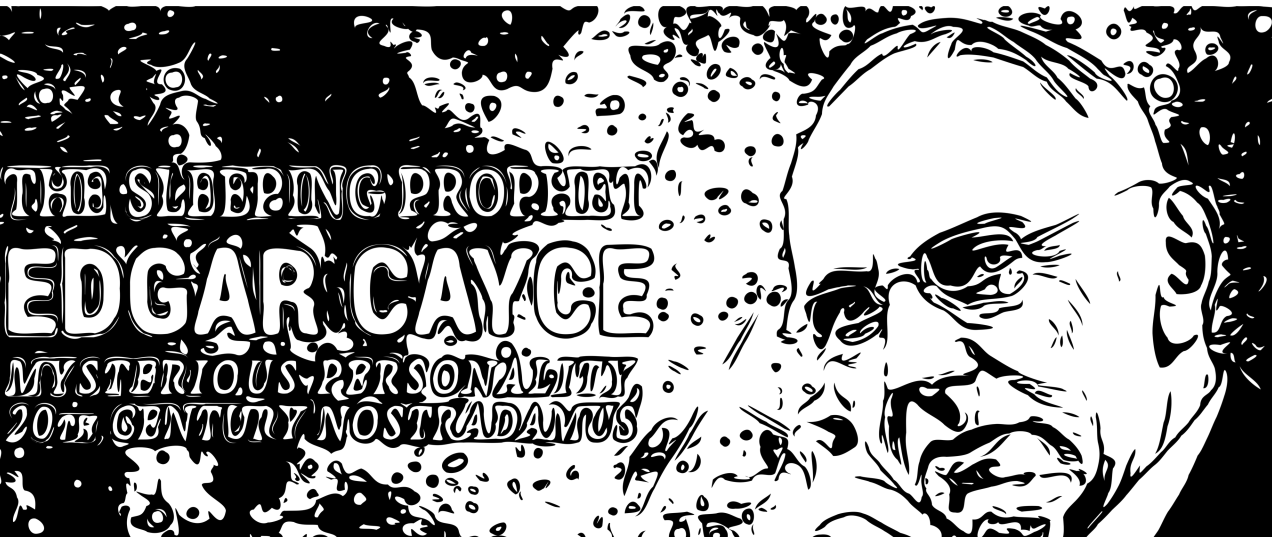

THE SLEEPING PROPHECY
EDGAR CAYCE
MYSTERIOUS PERSONALITY,
20TH CENTURY NOSTRADAMUS



EVENT:

CHRIST'S MILLENNIUM

FORETOLD BY:

SIR ISAAC NEWTON

DATE:

1/1/2000

ARTIFACT:

REFRACTED
LIGHT

NOTES:

SIR ISAAC NEWTON ACCURATELY PREDICTED THAT CHRIST'S MILLENNIUM WOULD BEGIN IN THE YEAR 2000 IN HIS BOOK OBSERVATIONS UPON THE PROPHECIES OF DANIEL, AND THE APOCALYPSE OF ST. JOHN.



EVENT:

END OF THE WORLD

DATE:

2000

FORETOLD BY:

MADAME
HELENA
PETROVA
BLAVATSKY

NOTES:

19TH CENTURY
MYSTIC MADAME
HELENA
PETROVA
BLAVATSKY, THE
FOUNDER OF
THEOSOPHY,
FORESAW THE
END OF THE
WORLD IN
2000.

ARTIFACT:

BLAVATSKY
PORTRAIT

EVENT:

SECOND COMING

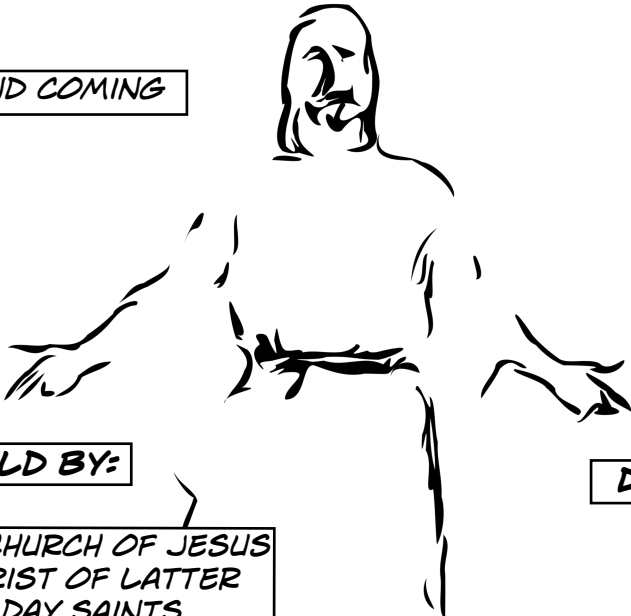

FORETOLD BY:

THE CHURCH OF JESUS
CHRIST OF LATTER
DAY SAINTS

DATE:

2000

WATCH AND BE READY

ARTIFACT:

WIDELY
DISTRIBUTED
LDS
PAMPHLET

NOTES:

THE PUBLICATION "WATCH AND BE READY: PREPARING FOR THE SECOND COMING OF THE LORD" NOTES HIS DESCENT FROM THE HEAVENS IN 2000, LANDING IN INDEPENDENCE, MISSOURI.



APOCALYPSE RELIQUARY: 1984-2000
IS A SUPPLEMENT TO THE FORTHCOMING
GRAPHIC NOVEL, **APOCALYPSE DIARY**.

THIS CATALOGUE IS PRINTED FOR THE SEOUL
MEDIACITY BIENNIAL 2018 AS PART OF THE
MONOSKOP EXHIBITION LIBRARY.

SPECIAL THANKS TO DUŠAN BAROK AND LIM
KYUNG YONG FOR THE INVITATION.

TREMENDOUS THANKS ARE DUE TO MASHINKA
FIRUNTS HAKOPIAN, AARON WINSLOW, DAVE
COWEN, AND TOM COMMITTA FOR THEIR
FEEDBACK AND INPUT ON THIS PROJECT.

ADDITIONAL THANKS TO TOBY ALTMAN &
EMILY BARTON ALTMAN (MAKE NO BONES
PODCAST) AND JOSEPH MOSCONI & ANDREW
MAXWELL (POETIC RESEARCH BUREAU) FOR
PROVIDING VENUES TO EXPLORE EARLY
ITERATIONS OF THIS WORK.

FINALLY, THANKS ARE OWED TO MANY
ARCHIVISTS OF THE APOCALYPSE, HOSTING A
RANGE OF SITES FROM WHICH THIS WORK
WAS COMPILED, INCLUDING BIBLE.CA, CHRIS
NELSON (A BRIEF HISTORY OF THE
APOCALYPSE, ABHOTA.COM), ALMA GEDDON
(IT'S THE END OF THE WORLD AS WE KNOW
IT... AGAIN, ALMA-GEDDON.COM), CURT VAN
DEN HEUVEL (THE DOOMSDAY LIST), AND
WIKIPEDIA (LIST OF DATE PREDICTED FOR
APOCALYPTIC EVENTS), AMONG MANY
OTHERS.

-DSS, 2018

